

Sold & Serviced By:

 **ELECTROMATE**

Toll Free Phone (877) SERV098

www.electromate.com

sales@electromate.com

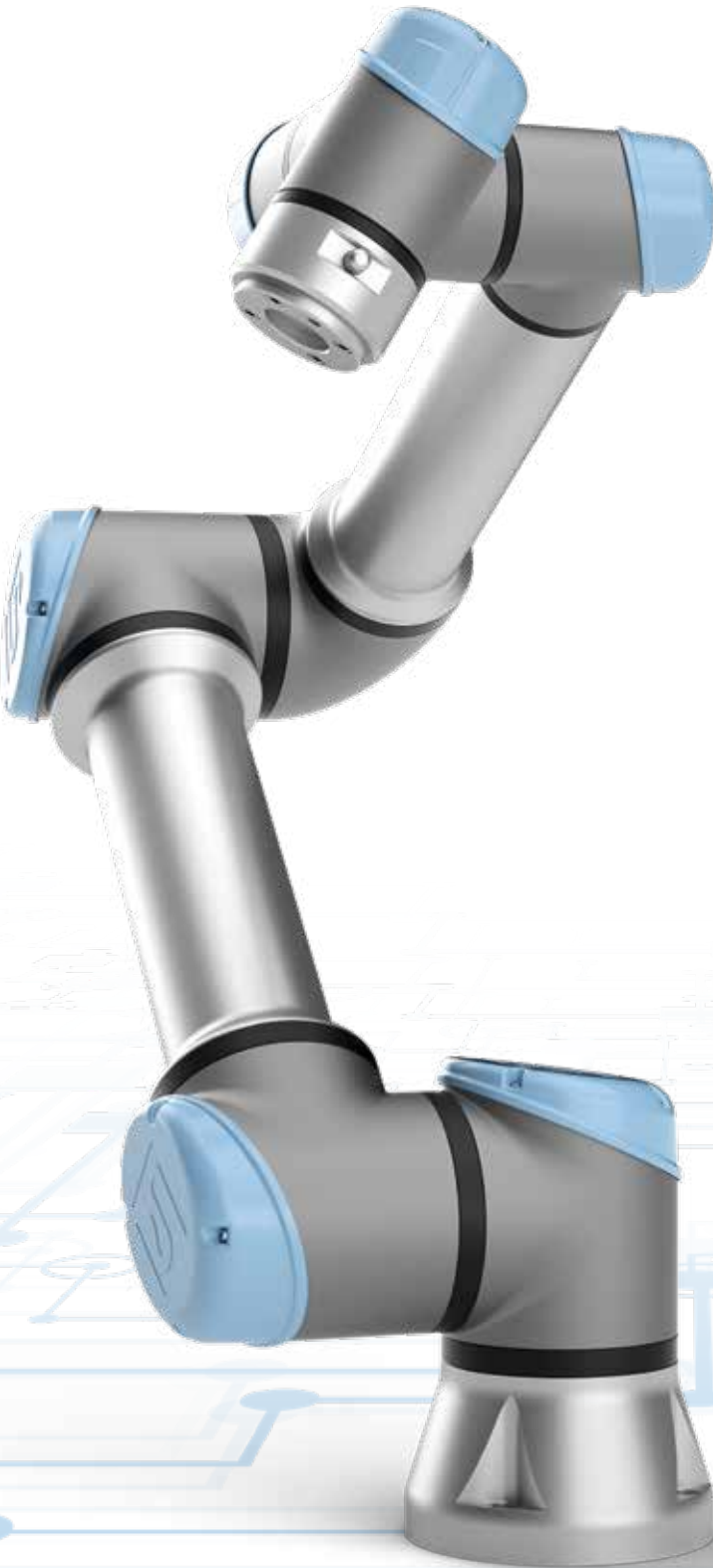

e-Series FROM UNIVERSAL ROBOTS

WORLD'S #1
COLLABORATIVE ROBOT



UNIVERSAL ROBOTS

Toll Free Phone (877) SERV098
www.electromate.com
sales@electromate.com

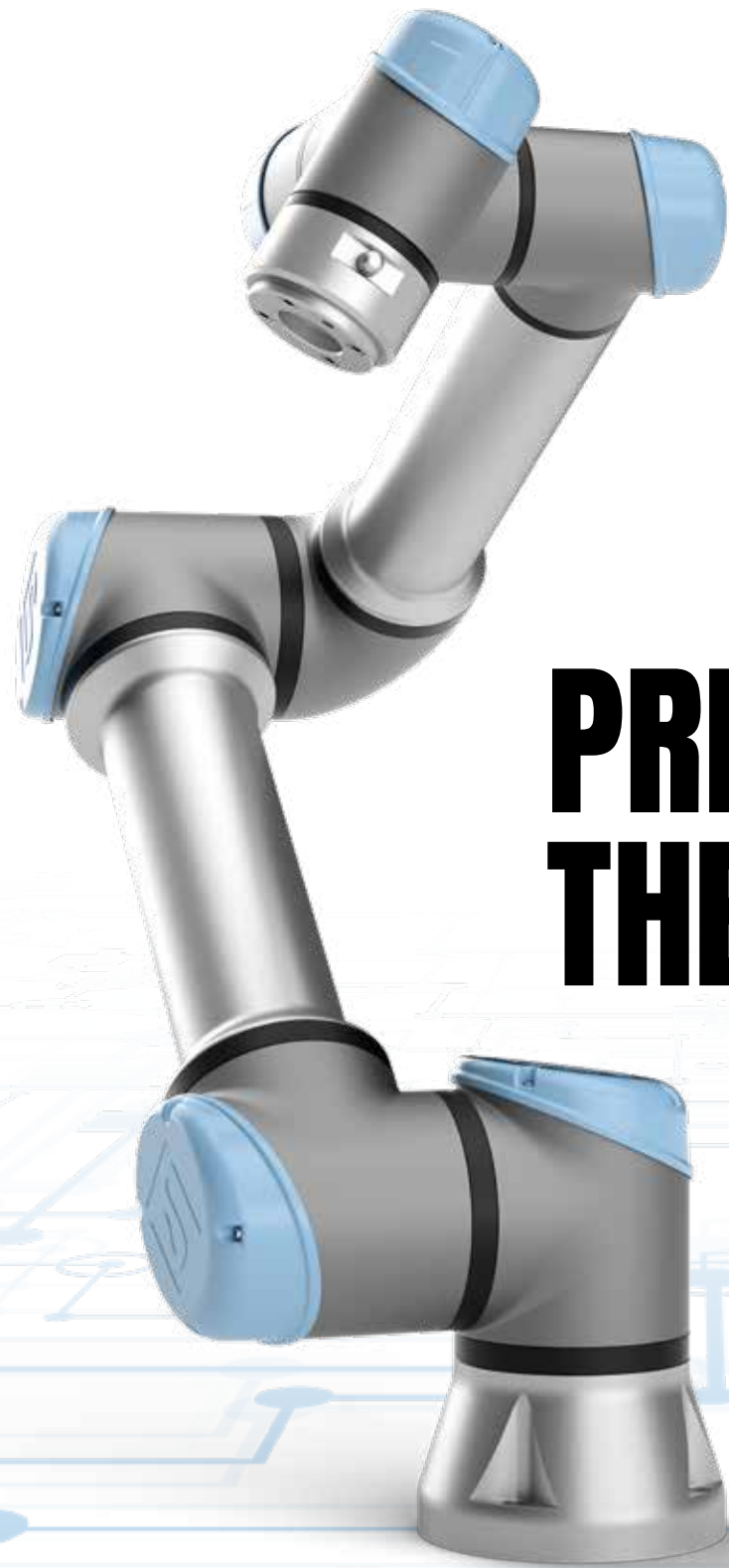

PRESENTING THE e-Series

STAY AHEAD OF THE GAME
WITH UNIVERSAL ROBOTS.
GET COLLABORATIVE
WITH THE e-Series TODAY.

THE 'e'

in e-Series stands for
empowering, ease of use,
everyone and evolution.

In an age of rapidly advancing technology and rising competition, manufacturers want to boost productivity, improve product quality and provide greater job satisfaction. Businesses constantly seek ways to innovate so they can continue to grow and stay relevant well into the future.

Change is the only constant in this era, and at Universal Robots, we believe that change is collaborative.

Collaboration means many things for us. It is the close proximity at which our collaborative robot (cobot) work hand-in-hand with operators, the seamless integration of our cobots into existing workflow and the multitude of ways in which we support customization of perfect robot solution through our online showroom Universal Robots+.

A top notch range of third-party end-effectors, accessories and software available at the **Universal Robots+** showroom allows our cobots to take on almost any task imaginable. Through cutting edge collaborative robot technology, we aim to make that change a universal one. Highly versatile and compact, our cobots are designed to integrate into virtually any production facility across the globe. We minimize our cobots' footprint so they can fit even into the smallest of production spaces, saving space and enhancing versatility. We also keep our cobots

affordable by offering free-of-charge training modules on the **Universal Robots Academy**. On top of that, our cobots do not require Annual Maintenance Contracts, so setting up, operating and maintaining our cobots is always a hassle-free process that anyone can manage.

In doing so, we turn the automation dream into reality for small and large businesses alike, so they can experience the magic of growing their business with cobots.

Likewise, growth is imperative for us as well. Since the sale of our first cobot in 2008, we have maintained our position as the market leader through continuous innovation and improvements. Our cobots hold more than 65 patents in areas like robot programming, safety and technology control, and have won over 35 awards and honours globally.

We are the market leader in the global collaborative robots market. Our cobots have played a pivotal role in the automation of production facilities worldwide in industries as diverse as aerospace and agriculture. Each day, we empower people to future proof their production lines, transform their businesses and remain at the forefront of technology. The e-Series is our latest offering.

65 PATENTS
in technology
control, safety and
robot programming

35 AWARDS
and honors
globally



SUPERCHARGE GROWTH WITH THE e-Series

GET AN EDGE OVER
YOUR COMPETITORS
WITH THE e-Series'
FIVE KEY BENEFITS.



Sold & Serviced By:



Toll Free Phone (877) SERV098
www.electromate.com
sales@electromate.com

*Built-in
Force/Torque
sensor*

*17 safety functions,
all EN ISO 13849-1,
Cat.3, PL d, certified
by TÜV NORD*

*Full EN ISO 10218-1
compliance, certified
by TÜV NORD*

*Easily
replaceable
joints*

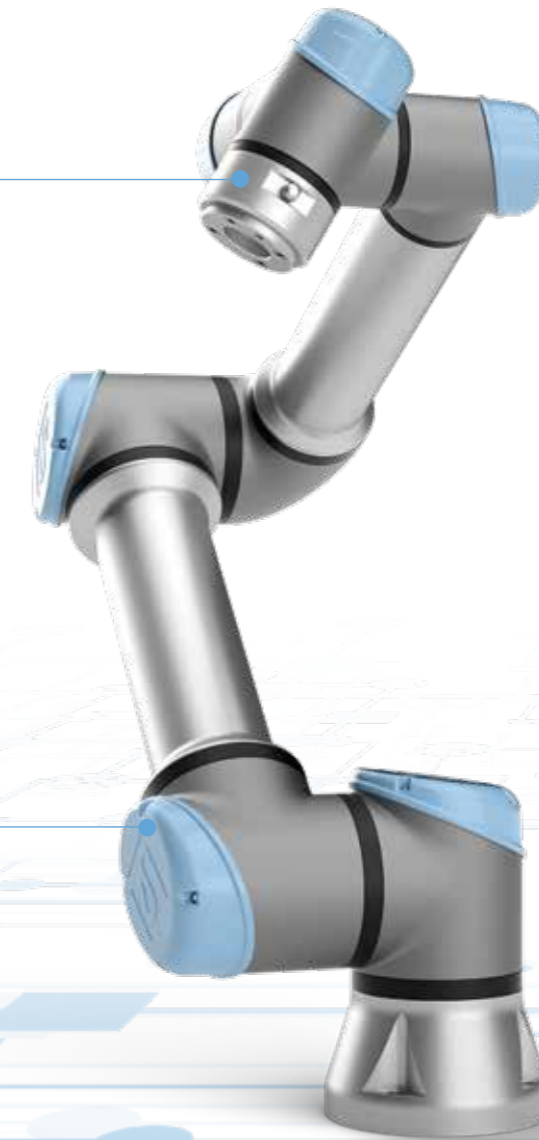

- *Intuitive programming flow*
- *Light and responsive teach pendant
Thin cable and wide screen*
- *Customizable stopping time and stopping distance*

Our e-Series cobots exemplify all that we believe in – productivity, adaptability and reliability. Equipped with intuitive programming and versatile use, the e-Series is able to complement production regardless of your industry, company size or product nature.

Built with the future in mind, the e-Series is designed to grow in capability alongside your business through the Universal Robots+ platform, taking on new tasks and finding new uses, so you will always be able to stay ahead of your competitors.

The e-Series takes robotic automation beyond what you can do today. Get ready to trailblaze into the future.

EASY PROGRAMMING

87 MINUTES TO TURN ANYONE INTO A ROBOT PROGRAMMER

Unrestricted possibilities anyone can embrace

Forget programming school. With Universal Robots Academy, anyone can become a robot programmer. Save on the costs of a professional programmer with Universal Robots. Our patented and intuitive 3D-interface allows anyone within the production facility to become a robot programmer even without prior experience. A user friendly and intuitive teach pendant allow operators to program a cobot by moving its arms to the desired waypoints, or simply using drag-and-drop functions on a touchscreen tablet.

Even the most complex tasks can be taught to our cobot with Universal Robots' Integrated Force Torque Sensor. Highly sensitive to even the slightest movements, the sensor enables our cobots to be programmed with precision for tasks where accuracy is of paramount importance.

INTEGRATED FORCE
TORQUE SENSOR

INTUITIVE
TEACH PENDANT

87
MINUTES

to turn anyone into a
robot programmer with
Universal Robots Academy

FAST SET-UP

1 HOUR TO UNPACK THE ROBOT, MOUNT IT AND PROGRAM THE FIRST TASK

Unparalleled convenience at your fingertips

Reduce robot deployment time from weeks to hours with Universal Robots. Our cobots do not require special electrical installations and can be connected to any regular power outlet. An intuitive user interface enables easy set-up, installation and integration into your production line.

Universal Robots+ products ensure hassle-free integration to maximize productivity by plug and produce. The robots also come with 32 industrial I/O connectors (24 volt) and Ethernet connectivity.

1 HOUR
is all it takes to unpack
the robot, mount it and
program the first task

FLEXIBLE

INFINITE WAYS OF DEPLOYMENT AND TASK AUTOMATION

Unlimited applications with one cobot

Explore the possibilities of robotic deployment with Universal Robots. Our cobots are lightweight, space saving and easy to re-deploy to multiple applications without changing production layouts. They can be moved between tasks quickly and are able to reuse programs for recurrent tasks, giving customers the flexibility to automate multiple manual tasks within one production facility even with just one cobot.

The e-Series' versatility is supported by the Universal Robots+ ecosystem, which offers a range of end-effectors and softwares to meet every configuration and application need.

Sold & Serviced By:

 ELECTROMATE

Toll Free Phone (877) SERV098
www.electromate.com
sales@electromate.com

SAFE & COLLABORATIVE

INSTALLED AND RUNNING IN MORE THAN 50 COUNTRIES

Unobstructed collaboration for greater productivity

Our cobots are able to take over strenuous tasks in dangerous or dull environments. With our safety features, you can fuse the best of human ingenuity with robot competency for accelerated productivity and growth.

50+
Number of countries
where our cobots are
installed and running

FAST PAYBACK

24 HOURS PRODUCTIVITY.
365 DAYS A YEAR

Unmatched returns for small and large businesses alike

Universal Robots brings all the advantages of advanced robotic automation and collaborative robots to our customers without any of the traditional added costs associated with robot programming, set-up and safety guarding.

Universal Robots makes robotic automation an option for small and medium enterprises, small batch production runs and other set-ups where traditional solutions may be too expensive. Firefighting equipment manufacturer Task Force Tips, USA, is an example where the safety guarding and inflexibility associated with traditional robotic solutions hindered the effectiveness of automation. With the addition of 4 Universal Robots cobots to tend their CNC machines, however, Task Force Tips was able to reduce staffing requirements while raising productive hours, registering a payback of 34 days.

Built with the needs of customers in mind, the e-Series boasts of a fully upgradable software platform that can grow in capabilities to make it a lasting and worthy long-term investment.



A TOOL FOR COMPETITIVE ADVANTAGES THROUGH MANUFACTURING EXCELLENCE

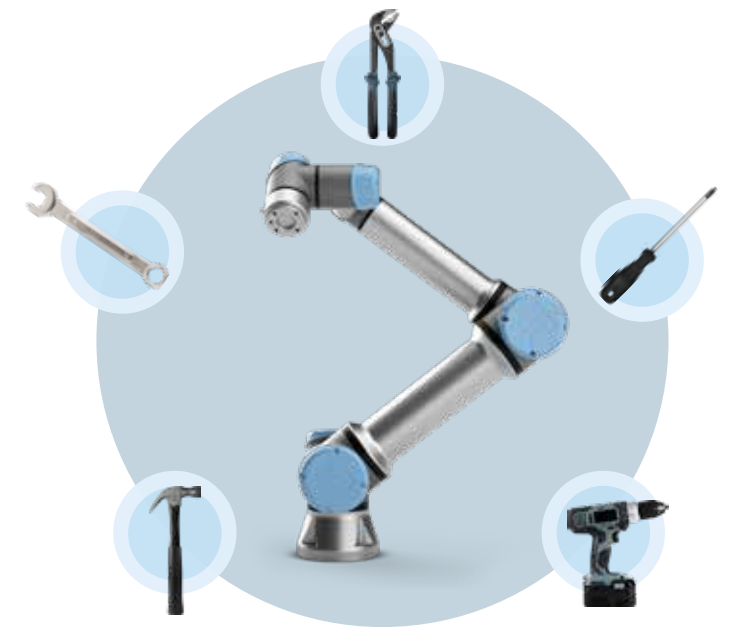

MEET THE e-Series FAMILY

A COLLABORATIVE SOLUTION
FOR EVERY NEED

The e-Series family has 3 members – the UR3e, UR5e and UR10e. Each cobot has a different reach and payload, but they share the same precision, accuracy and dependability that makes them a valuable addition to any production facility.

Our cobots are certified by TÜV NORD for ISO 10218-1 and safety functions are rated as Cat.3 PL d according to ISO 13849-1 and subject to risk assessment, can typically work safely alongside operators on the production line, all thanks to built-in and customizable safety features. At Universal Robots, we make safety imperative so our users are free to explore and experiment with the unlimited applications of our cobots for greater productivity and product quality with peace of mind.



UR3e

Small but powerful, the UR3e has a payload of 3 kg and reach radius of 500 mm. With 360-degree rotation on all wrist joints and infinite rotation on the end joint, this tabletop cobot handles high precision tasks and light assembly tasks with ease.



UR5e

The medium-sized member of the Universal Robots family is ideal for automating low-weight processing tasks with its 5 kg payload and 850 mm reach radius. Easy to program and fast to set up, the UR5e strikes the perfect balance between size and power.

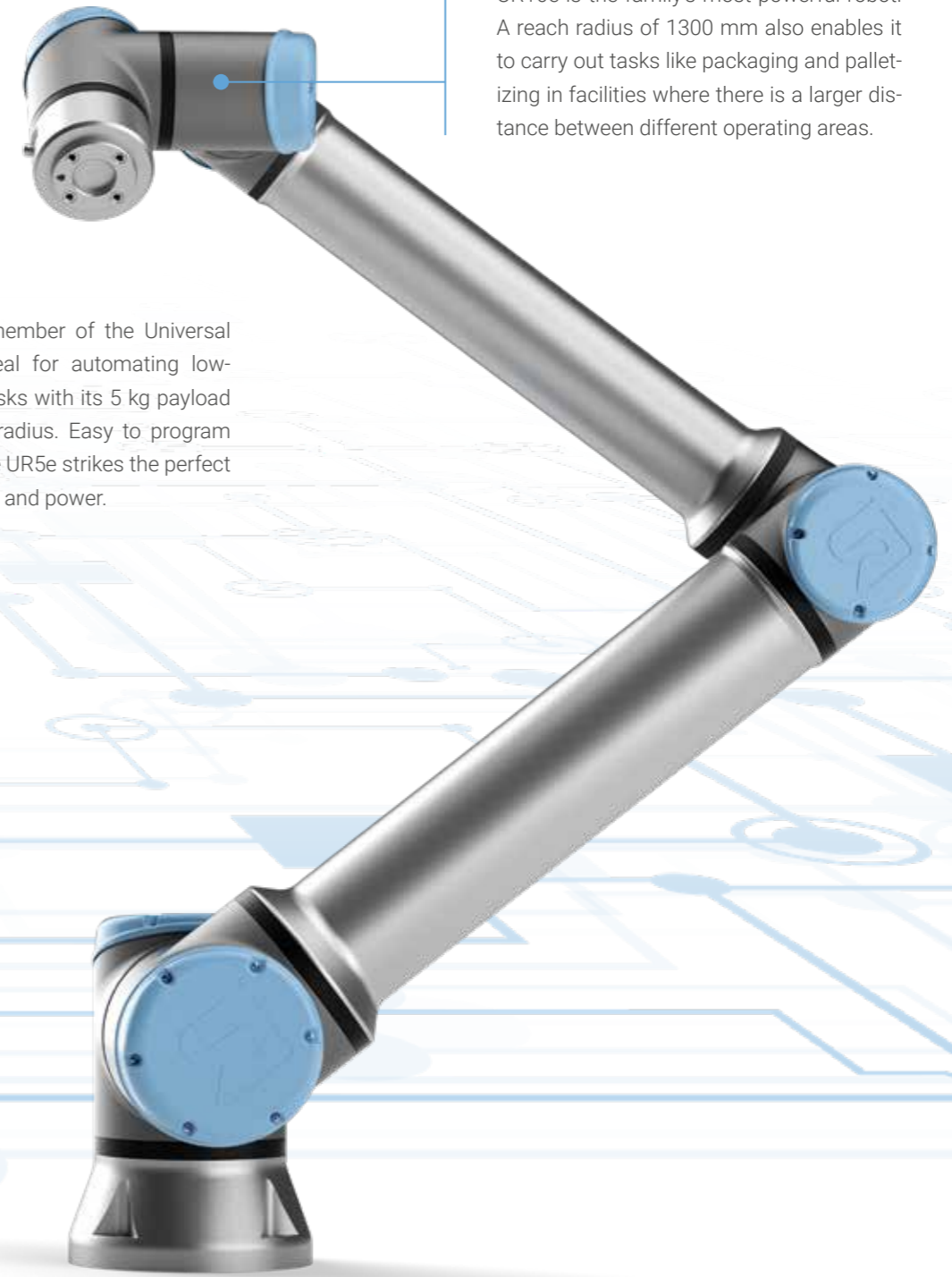

UR10e

With the ability to automate tasks up to 10 kg with no compromise on precision, the UR10e is the family's most powerful robot. A reach radius of 1300 mm also enables it to carry out tasks like packaging and palletizing in facilities where there is a larger distance between different operating areas.

Sold & Serviced By:

 **ELECTROMATE**

Toll Free Phone (877) SERV098

www.electromate.com

sales@electromate.com

ENABLING BUSINESS GROWTH IN COMPANIES OF ALL SIZES

VOODOO MANUFACTURING: TRIPLE PRODUCTION WITH COBOTS

Managing a rapidly growing 3D printing facility comes with its own set of challenges for Voodoo Manufacturing. The New York based start-up sought to automate the loading and unloading of plates in their 3D printers to take on large production runs without having to install or manage complicated equipment.

The UR10 proved to be the perfect solution for Voodoo Manufacturing. With its user-friendly interface and ease of programming, engineers at the company were able to get the UR10 up and running with the right gripper and program in just a matter of hours. Today, the cobot sits on a mobile base that roams Voodoo's 18,000 square foot premises, tending to 100 printers and running unmanned overnight shifts effortlessly.

Up to 5 times less expensive than a traditional industrial robot, cobots like the UR10 are designed to meet the needs of small and medium businesses like Voodoo. The cobot is able to pay itself back in less than six months, while increasing Voodoo's printer utilization rate so the company is well-prepared to scale up and grow its business. The UR10's versatility also means it is able to take on other tasks in the factory, including cleaning printer plates, quality inspection and packing to keep up with production demands as Voodoo expands.

With a multitude of possible uses, our cobots bring efficiency and precision to every aspect of production at an affordable cost, making them a worthy investment for companies of any size and industry for continued growth and expansion.

Sold & Serviced By:
 **ELECTROMATE**
 Toll Free Phone (877) SERV098
www.electromate.com
sales@electromate.com

5 **TIMES**
 less expensive
 than traditional
 industrial robots

6M **ROI**
 cobot payed itself
 back in less than
 six months



APPLICATIONS & INDUSTRIES

FLEXIBILITY, MADE FLAWLESS.

No matter what industry you are in, there will always be a place for an e-Series cobot in your facility or along your production line to automate a mundane task, take over a dangerous one, or simply change the way your employees work.

From the delicate handling of medical components to the large-scale assembly of bulky furniture, there is no task too difficult for the e-Series. Easily programmable, lightweight and compact, these cobots switch between tasks seamlessly and are economically viable even for the small-batch and mixed-product assembly lines.

Customizing your cobot is easy – simply choose from the wide range of end-effectors, accessories and software in the Universal Robots+ ecosystem to create a robotic solution that matches your production and industry needs perfectly.



UNLIMITED APPLICATIONS

Automate almost anything with Universal Robots cobots

Precision Palletizing

Combat the rising costs of new product packaging and shortened product life cycles by automating your packaging and palletizing processes. The e-Series is compatible with most palletizing and packaging applications, and can be easily re-programmed to take on new tasks or integrate with different machines to keep up with changing production needs.

Quality Assurance Inspection

Once equipped with a vision camera, the cobot can be used for non-destructive testing and 3D measurements to further guarantee product quality with little risk of human error. Automate even your quality assurance inspections with the e-Series' ability to detect and identify faulty parts before they are packaged and shipped.

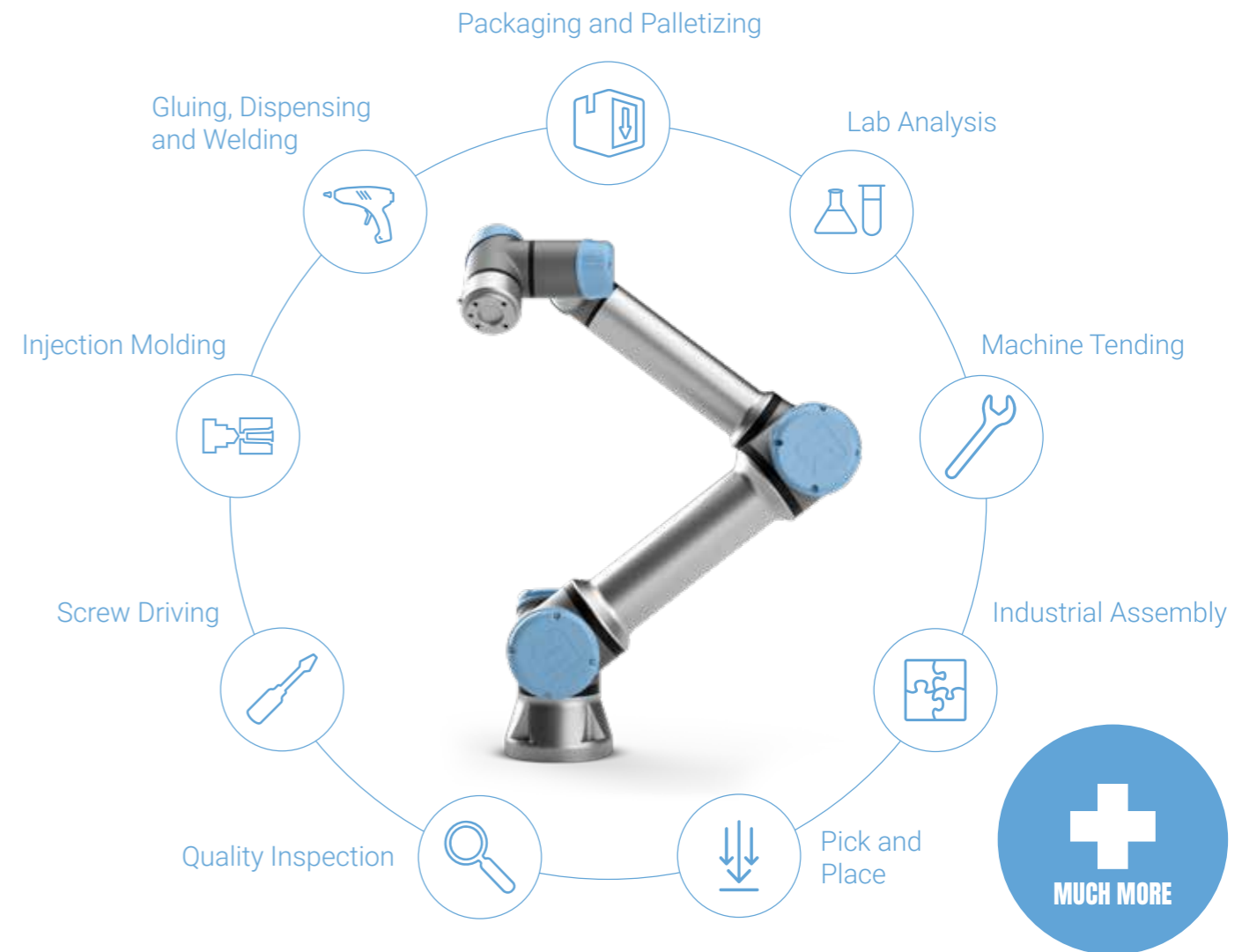

Injection Molding

Designed to connect directly with Injection Molding Machines (IMMs), the e-Series cobots are capable of handling injection molds for prototyping and short-run productions, even in unmanned conditions. Pressure control capabilities also ensure that our robots dose the exact quantity of a fluid each time for uniform product quality and minimal wastage.

Industrial Assembly

Achieve greater consistency and precision in your manufacturing process by automating assembly operations with the e-Series cobots. The cobots can be customized with various adaptor mechanisms to work with products of varying sizes and materials.

Industrial Pick and Place

Production never ceases with e-Series cobots. Equipped with vision sensors and grippers, the cobots are able to complete most pick and place applications autonomously while freeing up employees to take on higher-value work.

Unlimited Applications

The list doesn't stop here. Equipped with the right third-party product, the e-Series can take on virtually any task you can think of. If you can think it, the e-Series can do it.

INDUSTRIES

CHANGE PRODUCTION
AS YOU KNOW IT
WITH THE e-Series.



Aerospace & Defense

Once integrated with CNC machines, e-Series cobots work around the clock, running unmanned shifts to reduce labor costs and increase production. They can also be equipped with different end-effectors to handle components of varying sizes to meet production demands in the aerospace and defense industry.



Automotive & Subcontractor

From laser-cutting rigs to engine foundries, automate almost any stage in your automotive production line with the highly versatile e-Series. Our cobots can be seamlessly integrated into existing production lines to take over critical and precision tasks while maintaining production quality.



Food & Agriculture

Keep food and ingredient wastage to a minimum with the e-Series, which works around the clock with precision and minimal errors.



Electronics & Technology

The tech industry is a fast moving one with products constantly evolving to meet new needs. Keep up with the changes on your production line with a take on new tasks involving sensitive and dangerous machinery



Furniture & Equipment

Let the e-Series take over the labor intensive tasks on your furniture and equipment production line. On top of relieving workers of physical burdens, the e-Series also improves the fit and finish of your products by raising levels of precision and consistency in production.



Metal & Machining

Multiple processes and specialised products – these common characteristics of the metal and machining industry pose no deterrence to the e-Series. The cobots are well-equipped to work with accuracy and efficiency to enhance production.



Pharma & Chemistry

Designed to meet the healthcare industry's specifications for accuracy, precision and hygiene, the e-Series takes on mundane tasks like product dispensing and sorting with minimal error. The risk of human contamination in highly delicate tasks can also be reduced by deploying the e-Series in environments which require sterile handling.



Plastic & Polymers

With materials requiring different processing and temperature ranges, flexibility is crucial on the plastic and polymers production line. The highly agile e-Series can be used across all areas of plastic and polymer production to meet changing demands, extending production capabilities.



Scientific & Research

Accuracy and repeatability make the e-Series optimal for scientific research and analysis, where objective information gathering is crucial. The highly affordable cobots serve as valuable tools for teaching and development of innovative solutions at an increasing number of research institutes and universities.



Finishing & Polishing

Manage the multitude of small parts and highly complex assembly processes on your production line with the flexible and easily re-deployable e-Series. Equipped with inbuilt force control capabilities, the e-Series ensures that every screw and component in the tool manufacturing production can be installed with perfect positioning and accuracy.



Don't see your industry on the list?

The e-Series is designed to integrate seamlessly into all production facilities, regardless of what or where you're producing.

No matter what industry you belong to, change production as you know it with the e-Series.

Sold & Serviced By:

 **ELECTROMATE**

Toll Free Phone (877) SERV098

www.electromate.com

sales@electromate.com

UNIVERSAL ROBOTS+

CRAFT THE PERFECT COBOT APPLICATION



An ecosystem of solutions to customize your cobot applications that suit your requirements perfectly.

Your e-Series cobot isn't complete without the right end-effectors, accessories and software. Find everything you need at Universal Robots+, our one-stop showroom for products designed to complement our cobots and create the perfect robotic solution.

From cameras to sensors and software, during the year 2018 Universal Robots+ will feature 100+ certified products to meet every production and automation need. Designed by some of the world's best developers, these products are tested and optimized to work flawlessly with our cobots so you can expect fast and low-risk integration, an intuitive user experience and reliable operation. Direct support from our developers is also readily available to ensure that your set-up process and operations always remain smooth and hassle free.

With Universal Robots+, we place the infinite potential of collaborative robots right at your fingertips.

100+

CERTIFIED

Universal Robots+ products to meet every production and automation need

Explore the endless possibilities your cobot brings at:
universal-robots.com/plus/

UNIVERSAL ROBOTS ACADEMY

ANYONE CAN AUTOMATE



You don't have to be a programmer to make your e-Series cobot work exactly the way you want it to.

Available 24/7 and in 7 languages, Universal Robots Academy is our free online training program designed to help any cobot user pick up essential skills to program and operate a Universal Robots cobot without further assistance.

On top of 6 basic modules that cover skills like creating programs and configuring end-effectors, Universal Robots Academy also offers 3 more complex modules for users who are keen on advanced collaborative robot programming. All modules utilize hands-on experience, and interactive robot animations to make learning easier and more effective for users.

With cutting edge robotic simulations, Universal Robots Academy provides an opportunity for users to learn how to program a cobot even without access to physical cobots. At Universal Robots, we make programming simple, so that anyone can automate.

24/7 TRAINING
available with our free online training program

7 LANGUAGES
Choose between training in English, Spanish, German, French, Chinese, Korean, and Japanese.

Embark on your learning journey today at
universal-robots.com/academy/

UR3e

UR5e

UR10e

Performance

Power consumption	Approx. 100 W using a typical program	Approx. 200 W using a typical program	Approx. 350 W using a typical program
Collaboration operation	17 advanced adjustable safety functions incl. elbow monitoring. Remote Control according to ISO 10218	17 advanced adjustable safety functions incl. elbow monitoring. Remote Control according to ISO 10218	17 advanced adjustable safety functions incl. elbow monitoring. Remote Control according to ISO 10218
Certifications	EN ISO 13849-1, Cat.3, PL d, and EN ISO 10218-1	EN ISO 13849-1, Cat.3, PL d, and EN ISO 10218-1	EN ISO 13849-1, Cat.3, PL d, and EN ISO 10218-1
F/T Sensor - Force, x-y-z			
Range	30 N	50 N	100 N
Resolution	1.0 N	2.5 N	2.0 N
Accuracy	3.5 N	4.0 N	5.5 N
F/T Sensor - Torque, x-y-z			
Range	10 Nm	10 Nm	10 Nm
Resolution	0.02 Nm	0.04 Nm	0.02 Nm
Accuracy	0.10 Nm	0.30 Nm	0.60 Nm
Ambient temperature range	0-50°C*	0-50°C	0-50°C
Humidity	90%RH (non-condensing)	90%RH (non-condensing)	90%RH (non-condensing)

Specification

Payload	3 kg / 6.6 lbs	5 kg / 11 lbs	10 kg / 22 lbs
Reach	500 mm / 19.7 in	850 mm / 33.5 in	1300 mm / 51.2 in
Degrees of freedom	6 rotating joints DOF	6 rotating joints DOF	6 rotating joints DOF
Programming	Polyscope graphical user interface on 12 inch touchscreen with mounting	Polyscope graphical user interface on 12 inch touchscreen with mounting	Polyscope graphical user interface on 12 inch touchscreen with mounting

Movement

Pose Repeatability	+/- 0.03 mm, with payload, per ISO 9283		+/- 0.03 mm, with payload, per ISO 9283		+/- 0.05 mm, with payload, per ISO 9283	
Axis movement robot arm	Working range	Maximum speed	Working range	Maximum speed	Working range	Maximum speed
Base	± 360	±180°/Sec.	± 360	±180°/Sec.	± 360	±120°/Sec.
Shoulder	± 360	±180°/Sec.	± 360	±180°/Sec.	± 360	±120°/Sec.
Elbow	± 360	±180°/Sec.	± 360	±180°/Sec.	± 360	±180°/Sec.
Wrist 1	± 360	±360°/Sec.	± 360	±180°/Sec.	± 360	±180°/Sec.
Wrist 2	± 360	±360°/Sec.	± 360	±180°/Sec.	± 360	±180°/Sec.
Wrist 3	Infinite	±360°/Sec.	± 360	±180°/Sec.	± 360	±180°/Sec.
Typical TCP speed	1 m/Sec. / 39.4 in/Sec.		1 m/Sec. / 39.4 in/Sec.		1 m/Sec. / 39.4 in/Sec.	

Features

IP classification	IP54	IP54	IP54
ISO Class Cleanroom	5	6	5
Noise	Less than 60 dB(A)	Less than 65 dB(A)	Less than 65 dB(A)
Robot mounting	Any Orientation	Any Orientation	Any Orientation
I/O ports	Digital in 2 Digital out 2 Analog in 2 Analog out 0 UART interface (9.6k-5Mbps)	Digital in 2 Digital out 2 Analog in 2 Analog out 0 UART interface (9.6k-5Mbps)	Digital in 2 Digital out 2 Analog in 2 Analog out 0 UART interface (9.6k-5Mbps)
I/O power supply in tool	12V/24V 600mA continuous, 2A for shorter periods	12V/24V 600mA continuous, 2A for shorter periods	12V/24V 600mA continuous, 2A for shorter periods

Physical

Footprint	Ø 128 mm	Ø 149 mm	Ø 190 mm
Materials	Aluminium, Plastic, Steel	Aluminium, Plastic, Steel	Aluminium, Plastic, Steel
Tool (end-effector) connector type	M8 M8 8-pin	M8 M8 8-pin	M8 M8 8-pin
Cable length robot arm	6 m / 236 in	6 m / 236 in	6 m / 236 in
Weight including cable	11.2 kg / 24.7 lbs	20.6 kg / 45.4 lbs	33.5 kg / 73.9 lbs

* The robot can work in a temperature range of 0-50°C at a high continuous joint speed, ambient temperature is reduced.

TECHNICAL DETAILS

Control box

Features

IP classification	IP44
ISO Class Cleanroom	6
Ambient temperature range	0-50°
I/O ports	Digital in 16 Digital out 16 Analog in 2 Analog out 2 500 Hz control, 4 separated high speed quadrature digital inputs
I/O power supply	24V 2A
Communication	Control frequency: 500 Hz ModbusTCP: 500 Hz signal frequency ProfiNet and EthernetIP: 500 Hz signal frequency USB ports: 1 USB 2.0, 1 USB 3.0
Power source	100-240VAC, 47-440Hz
Humidity	90%RH (non-condensing)

Physical

Control box size (WxHxD)	475 mm x 423 mm x 268 mm 18.7 in x 16.7 in x 10.6 in
Weight	
UR3e	Max 13 kg / 28.7 lbs
UR5e	Max 13.6 kg / 30.0 lbs
UR10e	Max 13.6 kg / 30.0 lbs
Materials	Steel

Teach pendant

Features

IP classification	IP54
Humidity	90%RH (non-condensing)
Display resolution	1280 x 800 pixels
Physical	
Materials	Plastic
Weight including 1m of TP cable	1.6 kg / 3.5 lbs
Cable length	4.5 m / 177.17 in

Get started with Universal Robots today

Universal Robots has more than 50+ local offices and a wide network of channel partners (distributors and system integrators) worldwide.

Sold & Serviced By:

 **ELECTROMATE**



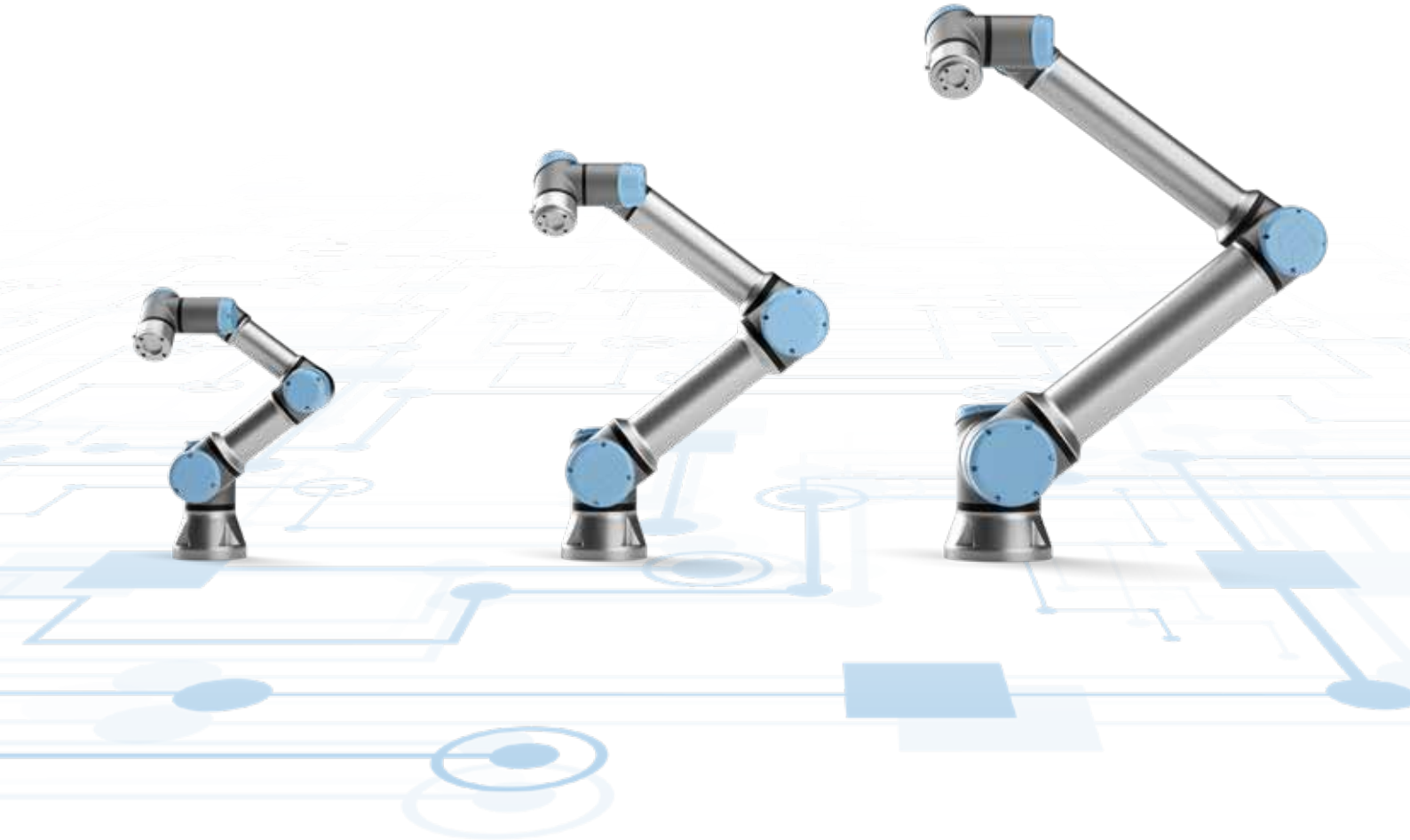

Toll Free Phone (877) SERV098
www.electromate.com
sales@electromate.com



Sold & Serviced By:

 **ELECTROMATE**

Toll Free Phone (877) SERV098
www.electromate.com
sales@electromate.com

-  UniversalRobots
-  universal-robots-a-s
-  Universal_Robot
-  UniversalRobotsVideo
-  universalrobots



UNIVERSAL ROBOTS

EMPOWERING PEOPLE