

SLS RODLESS SCREW DRIVE ACTUATOR

ENDURANCE TECHNOLOGY™



CONTENTS

| | |
|---------------------------------|--------|
| SLS Features..... | SLS_2 |
| Critical Speed Capacities..... | SLS_4 |
| Specifications..... | SLS_6 |
| Support Recommendations..... | SLS_7 |
| SLS10 Dimensions..... | SLS_9 |
| Switches..... | SLS_11 |
| Application Data Worksheet..... | SLS_13 |
| Selection Guidelines..... | SLS_14 |
| Ordering..... | SLS_15 |

LINEAR SOLUTIONS MADE EASY

Sold & Serviced By:

 **ELECTROMATE**

Toll Free Phone (877) SERV098

Toll Free Fax (877) SERV099

www.electromate.com

sales@electromate.com

SLS RODLESS SCREW DRIVE ACTUATOR

ENDURANCE TECHNOLOGYSM

Look for this endurance technology symbol indicating our durability design features

This rodless style actuator is designed for carrying light to moderate loads on a wide, rigid base. Based upon our LS pneumatic linear slide, it utilizes a guidance system consisting of two linear guide rods with recirculating ball bearings for stable, smooth and low friction operation. Built-to-order in stroke lengths up to 120 inches with multiple screw options available.

LOAD-BEARING CARRIER DESIGN

- Four recirculating ball bearings provide guidance, low friction loss and long life
- Load and moments are transmitted directly to the actuator body



WIDE TABLE SURFACE

- Precision machined table surface provides a large surface area for secure mounting

FORMED END CAP WIPERS

- Prevent contaminants from entering the sealing band area to protect internal components

MULTIPLE SCREW TECHNOLOGIES

YOU CAN CHOOSE:

- Solid nuts of bronze or engineered resins offering quiet performance at the lowest cost; anti-backlash available



- Ball nuts offer positioning accuracy and repeatability with longer life; low-backlash available



SCREW SUPPORT BEARINGS

- High thrust bearing assembly design isolates the motor from axial forces

Sold & Serviced By:

ELECTROMATE

Toll Free Phone (877) SERV098

Toll Free Fax (877) SERV099

www.electromate.com

sales@electromate.com

TOLOMATIC... LINEAR SOLUTIONS MADE EASY

EXTERNAL BUMPERS

- Bumpers protect the screw and nut assembly from damage at end of stroke

YOUR MOTOR HERE • YOU CAN CHOOSE:

- Motor or gearbox supplied and installed by Tolomatic
 - Specify the device to be installed and actuator ships with proper mounting hardware
 - Specify and ship your device to Tolomatic for factory installation
- LMI (inline) motor mount only

T-SLOT MOUNTING

- Actuator base has two T-Slot channels running the entire length for secure mounting
- Table includes two T-Slot channels for easy attachment of any load



LIGHTWEIGHT ALUMINUM DESIGN

- Black anodized extrusion design is optimized for rigidity and strength
- External switch channels on both sides allow easy placement and adjustment of position indicating switches

STAINLESS STEEL SEALING BAND

- Prevents contaminants from entering the screw and nut area for prolonged life
- Fatigue resistant stainless steel bands are specifically made to offer long life and will not elongate

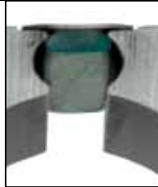

OPTIONS

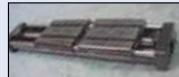

CARRIER OPTIONS

- AUXILIARY CARRIER** Doubles the load capacity and increases bending moments capacity significantly

- METRIC OPTION**

Provides metric tapped holes for mounting of load to carrier and of actuator



- SWITCHES**

Styles include: reed, hall-effect or triac. Select either 15ft potted cable with flying leads or 6in to quick-disconnect coupler with mating 15ft cable

Sold & Serviced By:

 **ELECTROMATE**

Toll Free Phone (877) SERV098

Toll Free Fax (877) SERV099

www.electromate.com

sales@electromate.com

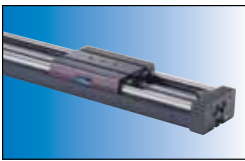

SLS10 Rodless Screw Drive Actuator

ACME SCREW SPECIFICATIONS

SLS/MLS10 ACME SCREW CRITICAL SPEED AND PV LIMITS

CRITICAL SPEED WITH 1/2" US CONVENTIONAL ACME SCREW

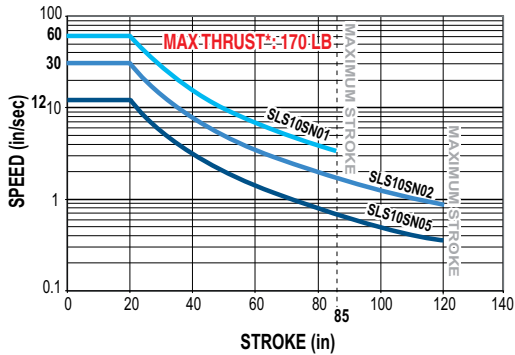

CRITICAL SPEED WITH 12mm METRIC ACME SCREW

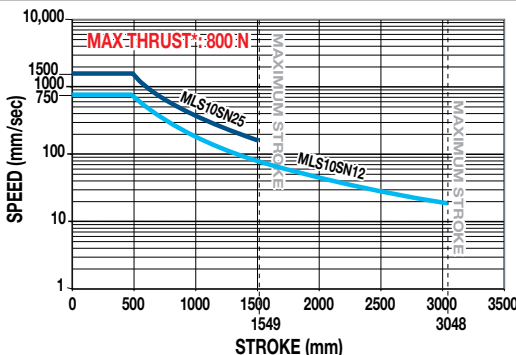

PV LIMITS: 1/2" 1 TPI US CONVENTIONAL ACME SCREW

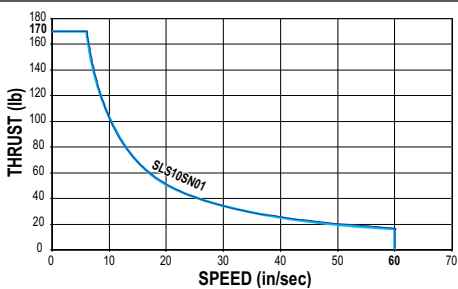

PV LIMITS: 12mm ACME METRIC SCREW w/25mm LEAD

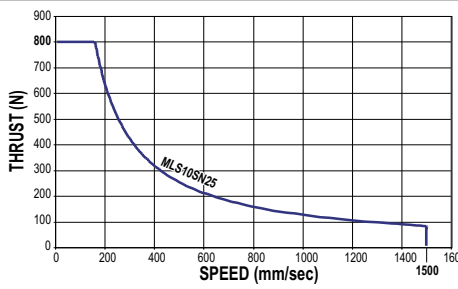

PV LIMITS: 1/2" 2 TPI US CONVENTIONAL ACME SCREW

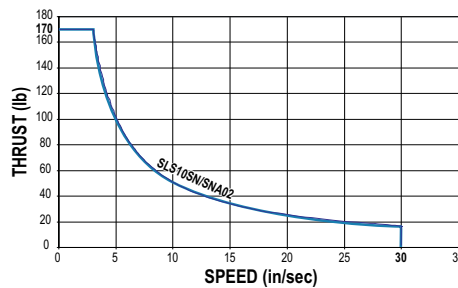

PV LIMITS: 12mm ACME METRIC SCREW w/12mm LEAD

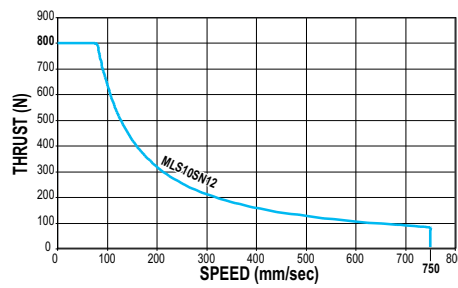

PV LIMITS: 1/2" 5 TPI US CONVENTIONAL ACME SCREW

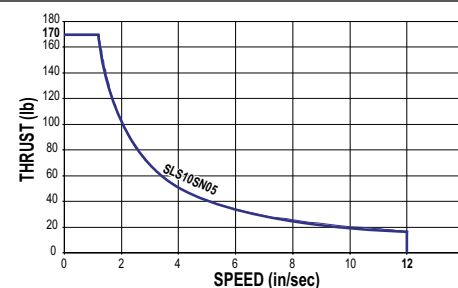

SN = Solid Nut
SNA = Solid Anti-backlash Nut

*** Maximum thrust is the maximum continuous dynamic thrust subject to Thrust x Velocity limitation.**

PV LIMITS: Any material which carries a sliding load is limited by heat buildup. The factors that affect heat generation rate in an application are the pressure on the nut in pounds per square inch and the surface velocity in feet per minute. The product of these factors provides a measure of the severity of an application.

$$\left(\frac{P}{(\text{Max. Thrust Rating})} \right) \times \left(\frac{V}{(\text{Max. Speed Rating})} \right) \leq 0.1$$

SLS10 Rodless Screw Drive Actuator

BALL SCREW SPECIFICATIONS

SLS/MLS10 BALL SCREW SPECIFICATIONS

CRITICAL SPEED WITH 3/8" US CONVENTIONAL BALL SCREW

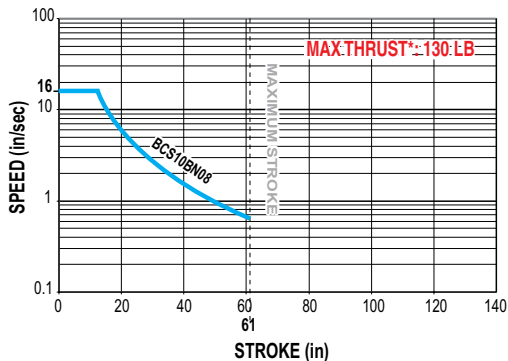

CRITICAL SPEED WITH 10mm METRIC BALL SCREW

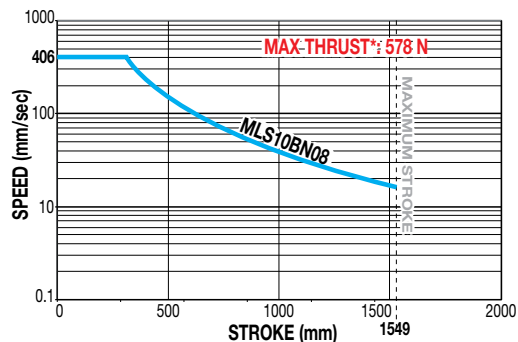

LIFE CALCULATION: 3/8" 8TPI US CONVENTIONAL BALL SCREW

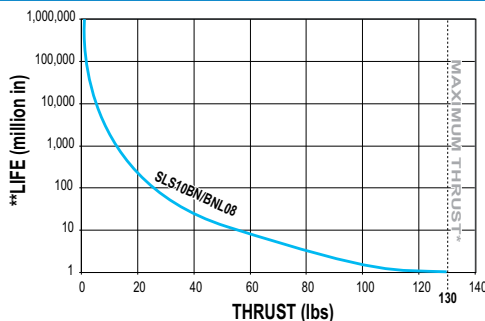

LIFE CALCULATION: 10mm METRIC BALL SCREW w/3.2mm LEAD

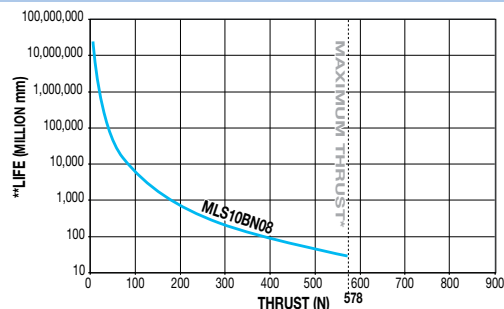

BN = Ball Nut



* Maximum thrust reflects 90% reliability for 1 million linear inches of travel.

**Life indicates theoretical maximum life of screw only, under ideal conditions and does not indicate expected life of actuator.

Sold & Serviced By:

 **ELECTROMATE**

Toll Free Phone (877) SERV098

Toll Free Fax (877) SERV099

www.electromate.com

sales@electromate.com

SLS10 Rodless Screw Drive Actuator

SPECIFICATIONS

SPECIFICATIONS RELATED TO ACTUATOR SIZE AND SCREW SELECTION

| US CONVENTIONAL LEAD SCREWS | | | | | | | | | | |
|-----------------------------|-----------------|------------|----------------|-----------------------|---------------|----------------------|---------------------|-------------------------------|-----------|--------------------------|
| ACTUATOR SERIES | SCREW DIA. (in) | SCREW TYPE | TPI (turns/in) | LEAD ACCURACY (in/ft) | BACKLASH (in) | MAXIMUM THRUST* (lb) | MAXIMUM STROKE (in) | INERTIA (lb-in ²) | | BREAKAWAY TORQUE (lb-in) |
| | | | | | | | | BASE ACTUATOR | PER/in | |
| | | | | | | | | In Line | OF STROKE | |
| SLS10 | 0.375 | BN | 08 | 0.004 | 0.015 | 130 | 61 | 0.0054 | 0.0005 | 1.063 |
| | 0.375 | BNL | 08 | 0.004 | 0.002 | 130 | 61 | 0.0054 | 0.0005 | 1.063 |
| | 0.500 | SN | 01 | 0.006 | 0.007 | 170 | 85 | 0.0554 | 0.0017 | 1.875 |
| | 0.500 | SN | 02 | 0.005 | 0.007 | 170 | 120 | 0.0262 | 0.0017 | 1.438 |
| | 0.500 | SNA | 02 | 0.005 | 0.003 | 170 | 120 | 0.0262 | 0.0017 | 1.438 |
| | 0.500 | SN | 05 | 0.006 | 0.007 | 170 | 120 | 0.0180 | 0.0017 | 1.250 |

| METRIC LEAD SCREWS | | | | | | | | | | |
|--------------------|-----------------|------------|----------------|------------------------|---------------|--------------------|---------------------|---|-----------|------------------------|
| ACTUATOR SERIES | SCREW DIA. (mm) | SCREW TYPE | LEAD (mm/turn) | LEAD ACCURACY (mm/300) | BACKLASH (mm) | MAXIMUM THRUST (N) | MAXIMUM STROKE (mm) | INERTIA (kg-m ² x 10 ⁻⁶) | | BREAKAWAY TORQUE (N-m) |
| | | | | | | | | BASE ACTUATOR | PER/mm | |
| | | | | | | | | In Line | OF STROKE | |
| MLS10 | 10 | BN | 3.2 | 0.13 | 0.38 | 578 | 1549 | 37.50 | 3.47 | 0.12 |
| | 10 | BNL | 3.2 | 0.13 | 0.05 | 578 | 1549 | 37.50 | 3.47 | 0.12 |
| | 12 | SN | 12 | 0.13 | 0.18 | 800 | 3048 | 6.49 | 0.41 | 0.17 |
| | 12 | SN | 25 | 0.13 | 0.18 | 800 | 1626 | 15.01 | 0.41 | 0.17 |

| | |
|-------------------|-------------------------|
| SCREW CODE | DESCRIPTION |
| SN | Solid Nut |
| SNA | Anti-backlash Solid Nut |
| BN | Ball Nut |
| BNL | Low-Backlash Ball Nut |



Contact Tolomatic for higher accuracy and lower backlash options.
 * For Acme screws, maximum thrust is the maximum continuous dynamic thrust subject to Thrust x Velocity limitation. For ball screws, maximum thrust reflects 90% reliability for 1 million linear inches of travel.

GENERAL ACTUATOR SPECIFICATIONS

| SLS US CONVENTIONAL ACTUATORS | | | | | |
|-------------------------------|---------------------|--------------------------------------|------------------------------|------------------------|------------|
| ACTUATOR SERIES | CARRIER WEIGHT (lb) | BASE WEIGHT (lb) (Including Carrier) | WEIGHT PER/IN OF STROKE (lb) | TEMPERATURE RANGE* (F) | IP RATING* |
| SLS10 | 1.54 | 6.05 | 0.404 | 40 - 130 | 44 |

| MLS METRIC ACTUATORS | | | | | |
|----------------------|---------------------|--------------------------------------|-----------------------------|------------------------|-------------|
| ACTUATOR SERIES | CARRIER WEIGHT (kg) | BASE WEIGHT (kg) (Including Carrier) | WEIGHT PER/mm OF STROKE (g) | TEMPERATURE RANGE* (C) | IP RATING** |
| MLS10 | 0.69 | 2.74 | 7.23 | 4 - 54 | 44 |



* Heat generated by the motor and drive should be taken into consideration as well as linear velocity and work cycle time. For applications that require operation outside of the recommended temperature range, contact Tolomatic.

** Protected against ingress of solid particles greater than .039 in (1mm) and splashing water.

LARGE FRAME MOTORS AND SMALLER SIZE ACTUATORS: Cantilevered motors need to be supported, if subjected to continuous rapid reversing duty and/or under dynamic conditions.

Sold & Serviced By:

 **ELECTROMATE**

Toll Free Phone (877) SERV098

Toll Free Fax (877) SERV099

www.electromate.com

sales@electromate.com

SLS10 Rodless Screw Drive Actuator

SPECIFICATIONS

FRICITION FORCE

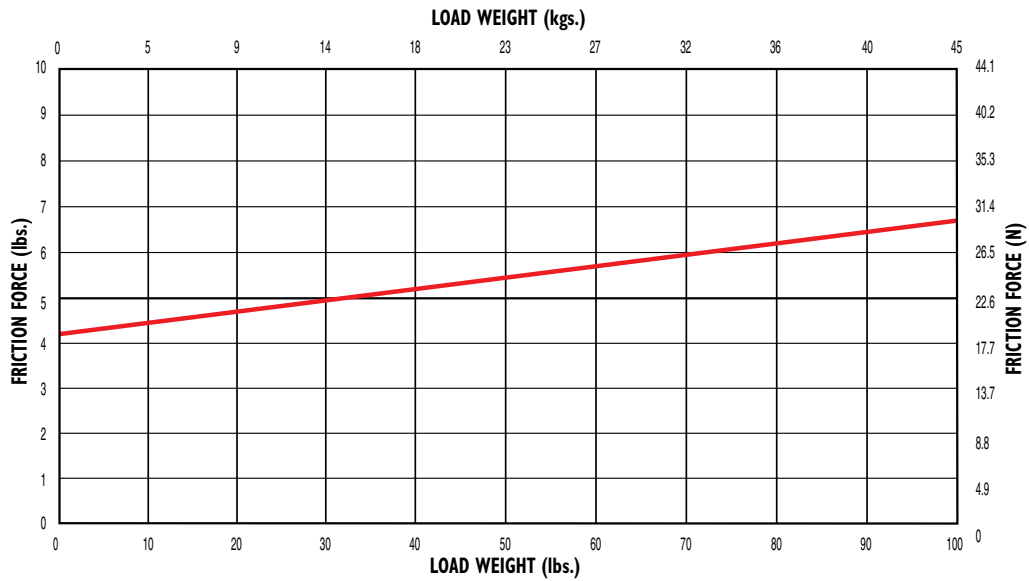

SUPPORT RECOMMENDATIONS

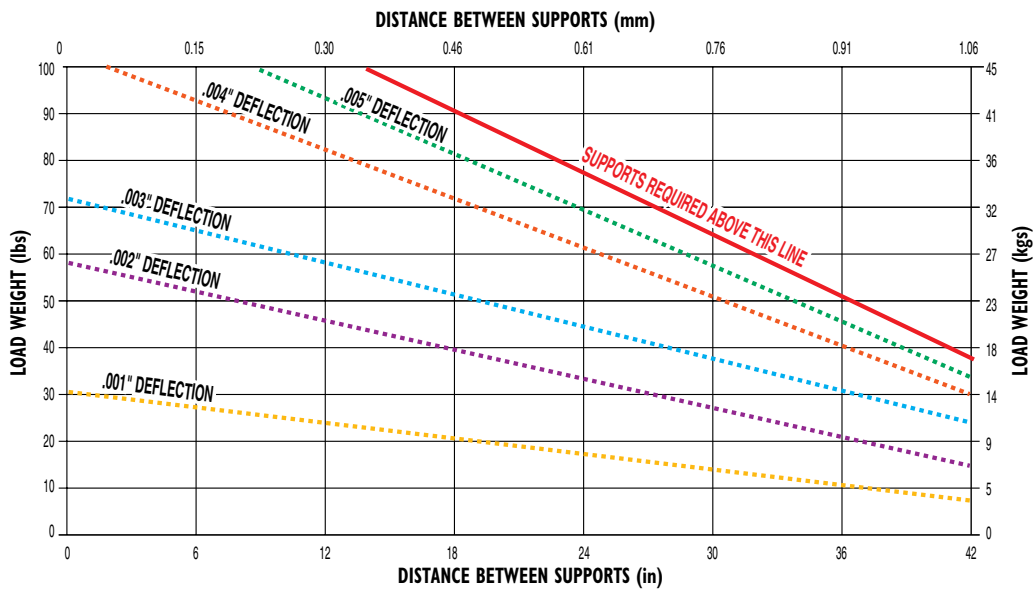

Sold & Serviced By:



Toll Free Phone (877) SERV098

Toll Free Fax (877) SERV099

www.electromate.com

sales@electromate.com

SLS10 Rodless Screw Drive Actuator

SPECIFICATIONS

DYNAMIC BENDING MOMENTS AND LOADS

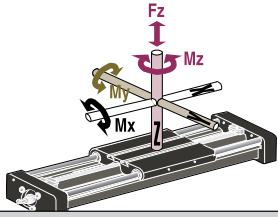
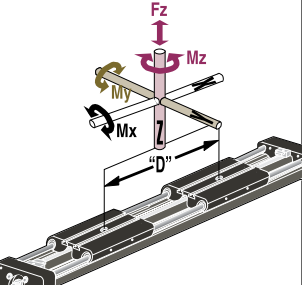
| | | MAXIMUM BENDING MOMENTS AND LOADS | US CONVENTIONAL | METRIC |
|---|------------------------------|-----------------------------------|-----------------|--------------|
| STANDARD CARRIER | | | SLS10 | MLS10 |
|  | Mx Moment (Roll) | (lb-in : N-m) | 80 | 9.0 |
| | My Moment (Pitch) | (lb-in : N-m) | 80 | 9.0 |
| | Mz Moment (Yaw) | (lb-in : N-m) | 125 | 14.1 |
| | Fz Load (Lateral) | (lb : N) | 100 | 445 |
| AUXILIARY CARRIER: Increases rigidity, load-carrying capacity and moments | | | SLS10 | MLS10 |
|  | Mx Moment (Roll) | *(lb-in : N-m) | 160 | 18.1 |
| | My Moment (Pitch) | *(lb-in : N-m) | 178 | 20.1 |
| | Mz Moment (Yaw) | *(lb-in : N-m) | 278 | 31.3 |
| | Fz Load (Lateral) | (lb : N) | 200 | 890 |
| | Minimum Dimension 'D' | (in : mm) | 5.5 | 169.7 |

⚠ Breakaway torque will increase when using the Auxiliary carrier option. When ordering, determine your working stroke and enter this value into the configuration string. Overall actuator length will automatically be calculated.

*Loads shown in table are at minimum "D" dimension, for ratings with longer "D" dimension see graph below

AUXILIARY CARRIER: BENDING MOMENT AT 'D' DISTANCE

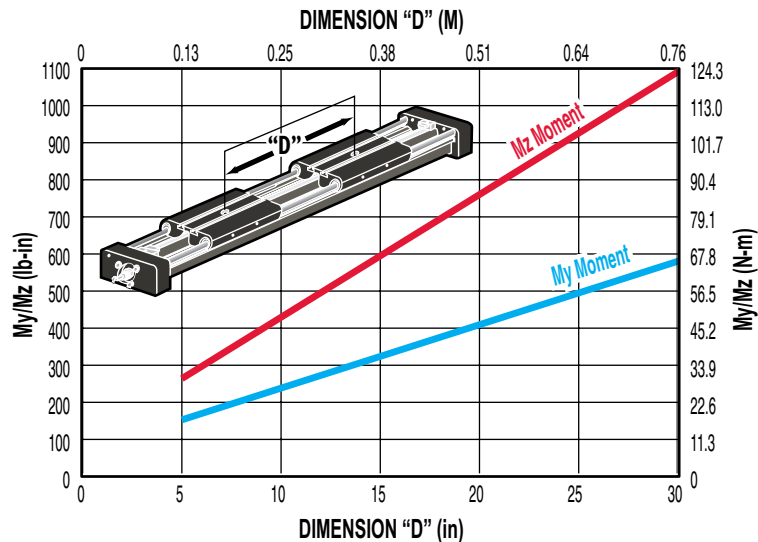

Rates shown on charts were calculated with these assumptions:
 1.) Coupling between carriers is rigid.
 2.) Load is equally distributed between carriers.

3.) Coupling device applies no misalignment loads to carriers.
 * Customer must specify Dimension "D" (Distance between carrier center lines) in configuration string.

Sold & Serviced By:

ELECTROMATE

Toll Free Phone (877) SERV098

Toll Free Fax (877) SERV099

www.electromate.com

sales@electromate.com

SLS10 Rodless Screw Drive Actuator

SPECIFICATIONS

LOAD DEFLECTION

Y-AXIS DEFLECTION

Figures calculated with the following considerations:

- 1.) Tube supports spaced at minimum distances for each bore size
- 2.) Measurement distance from F to center of carrier is 6 inches

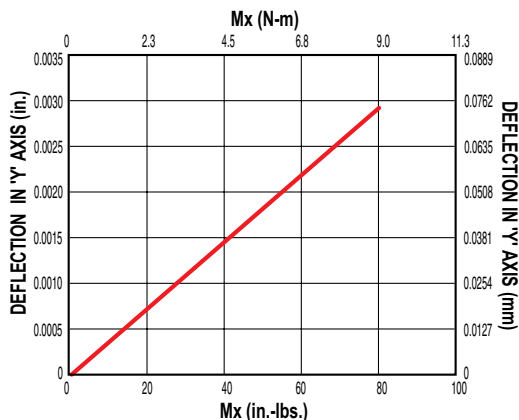
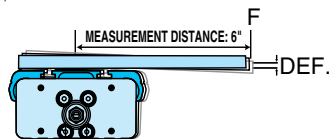

X-AXIS DEFLECTION

Figures calculated with the following considerations:

- 1.) Tube supports spaced at minimum distances for each bore size
- 2.) Measurement distance from F to center of carrier is 8 inches

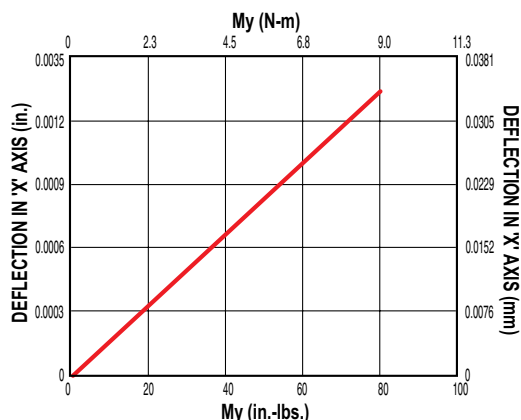
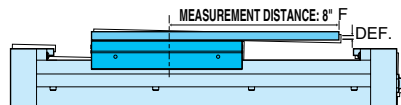

DIMENSIONS

SLS/MLS10: IN-LINE MOUNT FOR BRUSHLESS MOTORS AND GEARHEADS

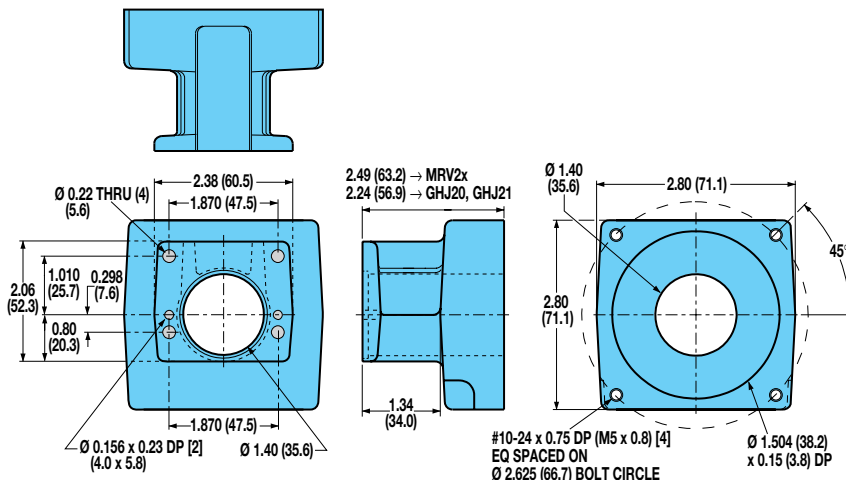

For gearhead dimensions and specifications, refer to literature #3600-4161

NOTE: MRB & MRV motors are discontinued contact Tolomatic for information on YMH (Your Motor Here)

Sold & Serviced By:

ELECTROMATE

Toll Free Phone (877) SERV098

Toll Free Fax (877) SERV099

www.electromate.com

sales@electromate.com

SLS10 Rodless Screw Drive Actuator

DIMENSIONS

SLS10/MLS10 ACTUATOR AND OPTIONS DIMENSIONS

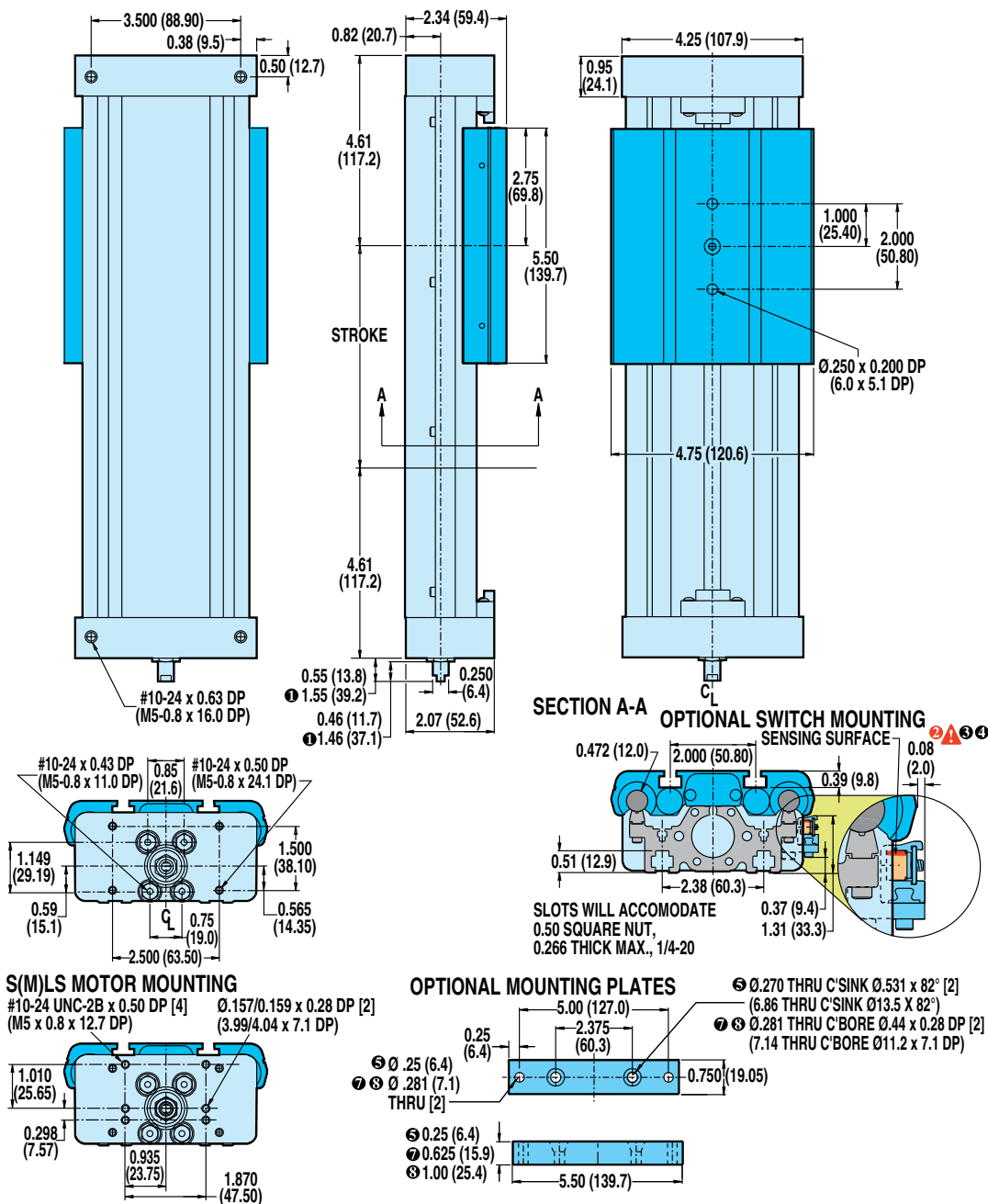

- ① FOR EXTENDED SHAFT
- ⚠ CAUTION: DO NOT OVERTIGHTEN SWITCH HARDWARE WHEN INSTALLING
- ② NOTE: The scored face of the switch indicates the sensing surface and must face toward the magnet
- ③ NOTE: Some actuators require switch mounting on a specific side of the actuator. Call Tolomatic 1-800-328-2174
- ④ KIT #0610-9010 Mounting Plate
- ⑤ KIT #0610-9066 Mounting Plate for use with 23 frame
- ⑥ KIT #0610-9067 Mounting Plate for use with 34 frame

Unless otherwise noted, all dimensions shown are in inches (Dimensions in parenthesis are in millimeters)

SLS Rodless Screw Drive Actuator

SWITCHES



There are 10 sensing choices: DC reed, form A (open) or form C (open or closed); AC reed (Triac, open); Hall-effect, sourcing, PNP (open); Hall-effect, sinking, NPN (open); each with either flying leads or QD (quick disconnect). Commonly used to send analog signals to PLC (programmable logic controllers), TLL, CMOS circuit or other controller device. These switches are activated by the actuator's magnet.

Switches contain reverse polarity protection. QD cables are shielded; shield should be terminated at flying lead end.

If necessary to remove factory installed switches, be sure to reinstall on the same side of actuator with scored face of switch toward internal magnet.

SPECIFICATIONS

| ORDER CODE | REED DC | | | | REED AC | | HALL-EFFECT DC | | | |
|-------------------------------|----------------------------------|-----------|----------------------------------|-----------|--|-----------|--------------------------------------|-----------|-----------------------------|-----------|
| | R T | R M | B T | B M | C T | C M | T T | T M | K T | K M |
| PART NUMBER | 3600-9082 | 3600-9083 | 3600-9084 | 3600-9085 | 3600-9086 | 3600-9087 | 3600-9088 | 3600-9089 | 3600-9090 | 3600-9091 |
| LEAD | 5m | QD* | 5m | QD* | 5m | QD* | 5m | QD* | 5m | QD* |
| CABLE SHIELDING | Unshielded | Shielded† | Unshielded | Shielded† | Unshielded | Shielded† | Unshielded | Shielded† | Unshielded | Shielded† |
| SWITCHING LOGIC | "A" Normally Open | | "C" Normally Open or Closed | | Triac Normally Open | | PNP (Sourcing) Normally Open | | NPN (Sinking) Normally Open | |
| MECHANICAL CONTACTS | Single-Pole Single-Throw | | Single-Pole Double-Throw | | Single-Pole Single-Throw | | NO, These Are Solid State Components | | | |
| COIL DIRECT | Yes | | Yes | | Yes | | — | | | |
| POWER LED | None | | None | | None | | None | | None | |
| SIGNAL LED | Red | | None | | None | | Red | | Red | |
| OPERATING VOLTAGE | 200 Vdc max. | | 120 Vdc max. | | 120 Vac max. | | 5 - 25 Vdc | | | |
| OUTPUT RATING | — | | — | | — | | 25 Vdc, 200mA dc | | | |
| OPERATING TIME | 0.6 msec max. (including bounce) | | 0.7 msec max. (including bounce) | | — | | < 10 micro sec. | | | |
| OPERATING TEMPERATURE | -40°F [-40°C] to 158°F [70°C] | | | | | | 0°F [-18°C] to 150°F [66°C] | | | |
| RELEASE TIME | 1.0 msec. max. | | — | | — | | — | | | |
| ON TRIP POINT | — | | — | | — | | 150 Gauss maximum | | | |
| OFF TRIP POINT | — | | — | | — | | 40 Gauss minimum | | | |
| **POWER RATING (WATTS) | 10.0 § | | 3.0 §§ | | 10.0 | | 5.0 | | | |
| VOLTAGE DROP | 2.6 V typical at 100 mA | | NA | | — | | — | | | |
| RESISTANCE | 0.1 Ω Initial (Max.) | | | | | | — | | | |
| CURRENT CONSUMPTION | — | | — | | 1 Amp at 86°F [30°C] 0.5 Amp at 140°F [60°C] | | 200 mA at 25 Vdc | | | |
| FREQUENCY | — | | — | | 47 - 63 Hz | | — | | | |
| CABLE MIN. BEND RADIUS | STATIC | | 0.630" [16mm] | | | | | | | |
| | DYNAMIC | | Not Recommended | | | | | | | |

⚠ CAUTION: DO NOT OVER TIGHTEN SWITCH HARDWARE WHEN INSTALLING!

⚠ ** WARNING: Do not exceed power rating (Watt = Voltage X Amperage). Permanent damage to sensor will occur.

*QD = Quick Disconnect; Male coupler is located 6" [152mm] from sensor.

Female coupler to flying lead (part #2503-1025) distance is 197" [5m] also see Cable Shielding specification above

⚠ REPLACEMENT OF QD SWITCHES MANUFACTURED BEFORE JULY 1, 1997: It will be necessary to replace or rewire the female end coupler.



Reed Switch Life Expectancy: Up to 200,000,000 cycles (depending on load current, duty cycle and environmental conditions)

†Shielded from the female quick disconnect coupler to the flying leads. Shield should be terminated at flying lead end.

§ Maximum current 500mA (not to exceed 10VA) Refer to Temperature vs. Current graph and Voltage Derating graph

§§ Maximum current 250mA (not to exceed 3VA) Refer to Temperature vs. Current graph and Voltage Derating graph

Sold & Serviced By:

ELECTROMATE

Toll Free Phone (877) SERV098

Toll Free Fax (877) SERV099

www.electromate.com

sales@electromate.com

SLS Rodless Screw Drive Actuator

PERFORMANCE

TEMP. vs CURRENT, DC REED

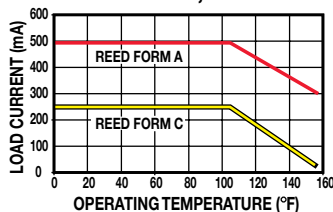

TEMP. vs CURRENT, AC REED

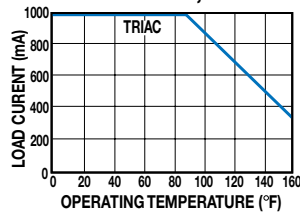

VOLTAGE DERATING, DC REED

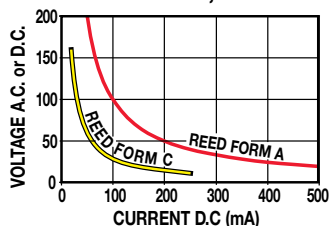

WIRING DIAGRAMS

R T & **R M** DC REED, FORM A

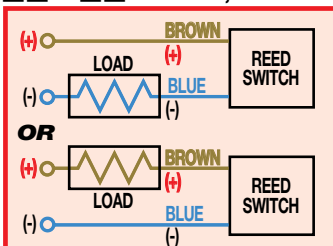

C T & **C M** AC REED, TRIAC

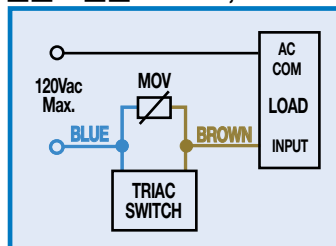

INSTALLATION INFORMATION



⚠
THE NOTCHED FACE OF THE SWITCH INDICATES THE SENSING SURFACE AND MUST FACE TOWARD THE MAGNET.

B T & **B M** DC REED, FORM C

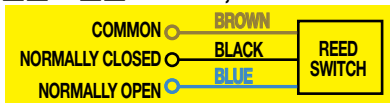

T T & **T M** HALL-EFFECT, SOURCING, PNP

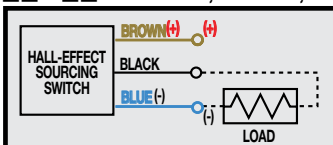

X T & **X M** HALL-EFFECT, SINKING, NPN

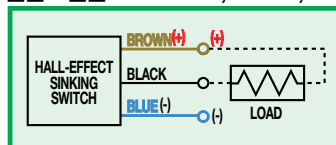

Sold & Serviced By:



Toll Free Phone (877) SERV098
Toll Free Fax (877) SERV099
www.electromate.com
sales@electromate.com

COMPILE APPLICATION REQUIREMENTS

ORIENTATION

Horizontal

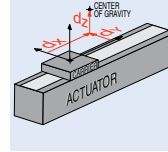

Side

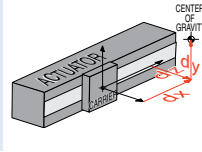

Horizontal Down

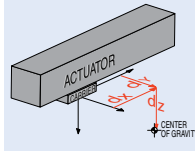

Vertical

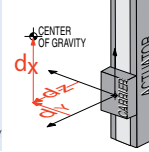

Angled °

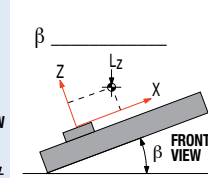
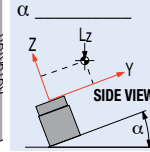

Load attached to carrier OR Load supported by other mechanism

DISTANCE FROM CENTER OF CARRIER TO LOAD CENTER OF GRAVITY

d_x _____

d_y _____

d_z _____

inch
(U.S. Standard)

millimeter
(Metric)

STROKE LENGTH

inch (S/I)
(U.S. Standard)

millimeters
(Metric)

NOTE: If load or force on carrier changes during cycle use the highest numbers for calculations

LOAD

lb.
(U.S. Standard)

kg.
(Metric)

THRUST REQUIRED

lbf.
(U.S. Standard)

N
(Metric)

F_z _____
 F_y _____

BENDING MOMENTS APPLIED TO CARRIER

in.-lbs.
(U.S. Standard)

N-m
(Metric)

M_x _____

M_y _____

M_z _____

PRECISION

Repeatability _____

inch

millimeters

OPERATING ENVIRONMENT

Temperature, Contamination, etc.

MOVE PROFILE

Move Distance _____

inch

millimeters

Dwell Time After Move _____

Max. Speed _____

in/sec

mm/sec

MOVE TIME

sec

NO. OF CYCLES

per minute

per hour

MOTION PROFILE

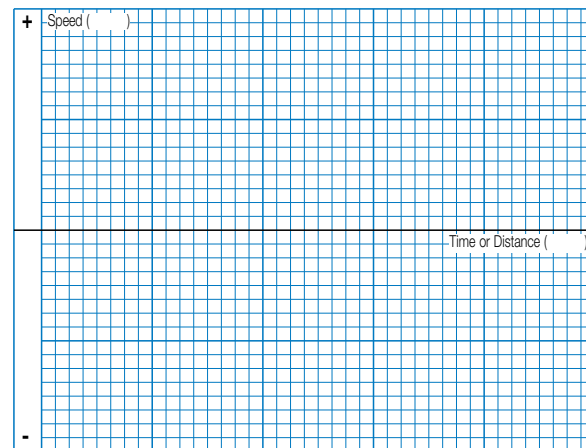

Graph your most demanding cycle, including accel/decel, velocity and dwell times. You may also want to indicate load variations and I/O changes during the cycle. Label axes with proper scale and units.

CONTACT INFORMATION

Name, Phone, Email _____
Co. Name, Etc. _____

APPLICATION DATA WORKSHEET

Fill in known data. Not all information is required for all applications

Sold & Serviced By:

ELECTROMATE

Toll Free Phone (877) SERV098

Toll Free Fax (877) SERV099

www.electromate.com

sales@electromate.com

SELECTION GUIDELINES

The process of selecting a load bearing actuator for a given application can be complex. It is highly recommended that you contact Tolomatic or a Tolomatic Distributor for assistance in selecting the best actuator for your application. The following overview of the selection guidelines are for educational purposes only.

1 COMPARE LOAD TO MAXIMUM LOAD CAPACITIES

Calculate the application load (combination of load mass and forces applied to the carrier) and application bending moments (sum of all moments M_x , M_y , and M_z applied to the carrier). Be sure to evaluate the magnitude of dynamic inertia moments. When a rigidly attached load mass is accelerated or decelerated, its inertia induces bending moments on the carrier. Careful attention to how the load is decelerated at the end of the stroke is required for extended actuator performance and application safety. If either load or any of your moments exceed figures indicated in the Moment and Load Capacity table (pg. SLS.8) for the actuator consider:

- 1) Higher capacity bearing style

- 2) A different actuator style (B3S, MXE, etc.)
- 3) Auxiliary carrier
- 4) External guide system

2 CALCULATE LOAD FACTOR L_F

For loads with a center of gravity offset from the carrier account for both applied (static) and dynamic loads. The load factor (L_F) must not exceed the value of 1.

$$L_F = \frac{M_x}{M_{x_{max}}} + \frac{M_y}{M_{y_{max}}} + \frac{M_z}{M_{z_{max}}} + \frac{F_y}{F_{y_{max}}} + \frac{F_z}{F_{z_{max}}} \leq 1$$

If L_F does exceed the value of 1, consider the four choices listed in step #2.

3 ESTABLISH YOUR MOTION PROFILE AND CALCULATE ACCELERATION RATE

Using the application stroke length and maximum carrier velocity (or time to complete the linear motion), establish the motion profile. Select either triangular (accel-decel) or trapezoidal (accel-constant speed-decel) profile. Now calculate the maximum acceleration and de-

celeration rates of the move. Speed should not exceed critical speed value as shown in graph (page SLS_4-5) for the screw/nut combination chosen. Also, do not exceed safe rates of dynamic inertia moments determined in step #3.

4 SELECT THE LEAD SCREW

Based on the application requirements for accuracy, backlash, quiet operation, life, etc. select the appropriate lead screw type (Acme screw with a solid nut or ball screw with a standard or anti-backlash nut) and the pitch (lead). For additional information on screw selection, consult "Which Screw? Picking the Right Technology" (#9900-4644) available at www.tolomatic.com.

5 SELECT MOTOR (GEARHEAD IF NECESSARY) AND DRIVE

To help select a motor and drive, use the sizing equations located in the Engineering Resources section [ENGR] to calculate the application thrust and torque requirements. Refer to Motor sections [MRV] & [MRS] to determine the motor and drive.

6 DETERMINE T-NUTS/MOUNTING PLATE REQUIREMENTS

- Consult the Support Recommendations graph for the model selected (page SLS_7)
- Cross reference the application load and maximum distance between supports
- Select the appropriate number of T-nuts, and mounting plates if required for motor and adapter clearance.

7 CONSIDER OPTIONS

- Choose metric or inch (US Conventional) load mounting.
- Switches - Reed, Solid State PNP or NPN, all available normally open or normally closed

SPEED FACTOR

FOR APPLICATIONS WITH HIGH SPEED OR SIGNIFICANT SHOCK AND VIBRATION: Calculated values of loads and bending moments must be increased by speed factor from the graph below to obtain full rated life of profiled rail bearing system.

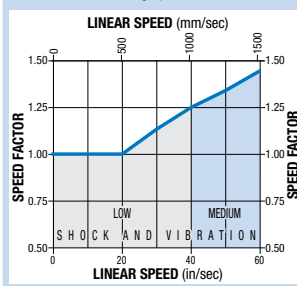

Sold & Serviced By:

ELECTROMATE

Toll Free Phone (877) SERV098

Toll Free Fax (877) SERV099

www.electromate.com

sales@electromate.com

SLS Rodless Screw Drive Actuator

ORDERING

BASE MODEL SPECIFICATIONS

SLS 10 SNO2 SK25 LMI

MODEL TYPE

SLS SLS Series US Conventional Screw Drive
MLS MLS Series Metric Screw Drive

TUBE BORE DIAMETER

10 1-inch (25 mm) bore

NUT/SCREW CONFIGURATION

INCH (US Conventional) MODELS

| SOLID NUT / PITCH (turn/in) | SERIES |
|-----------------------------|--------|
| SN01 | SLS10 |
| SN02 | SLS10 |
| SNA02 | SLS10 |
| SN05 | SLS10 |

| BALL NUT / PITCH (turn/in) | SERIES |
|----------------------------|--------|
| BN08 | SLS10 |
| BNL08 | SLS10 |

METRIC MODELS

| SOLID NUT / LEAD (mm/turn) | SERIES |
|----------------------------|--------|
| SN12 | MLS10 |
| SN25 | MLS10 |

| BALL NUT / LEAD (mm/turn) | SERIES |
|---------------------------|--------|
| BN08 | MLS10 |
| BNL08 | MLS10 |

STROKE LENGTH

SK Stroke, then enter desired stroke length in decimal inches

OPTIONS SPECIFICATIONS

DC18 KT2 TN4 MP2

MOTOR MOUNTING / REDUCTIONS

(must choose one)

LMI In-Line mounting
****LMX** Extended shaft - old style (see note)

**** For replacement actuators with extended motor shafts purchased prior to 6/24/02 use LMX**

AUXILIARY CARRIER

DC _ Auxiliary Carrier, then center-to-center spacing desired in decimal inches. (Center-to-Center spacing will add to overall dead length and will not subtract from the stroke length)

Your Motor Here



CUSTOM MOTOR MOUNTS. 15 DAYS.

Tolomatic electric actuators are compatible with over 60 motor manufacturers and hundreds of motor models.

SWITCHES

RM _ Reed Switch (Form A) with 5-meter lead/QD (*quick-disconnect*), & quantity
RT _ Reed Switch (Form A) with 5-meter lead, and quantity desired
BM _ Reed Switch (Form C) with 5-meter lead/QD, and quantity desired
BT _ Reed Switch (Form C) with 5-meter lead, and quantity desired
KM _ Hall-effect Sinking Switch with 5-meter lead/QD, and quantity desired
KT _ Hall-effect Sinking Switch with 5-meter lead, and quantity desired
TM _ Hall-effect Sourcing Switch with 5-meter lead/QD, and quantity desired
TT _ Hall-effect Sourcing Switch with 5-meter lead, and quantity desired
CM _ TRIAC Switch with 5-meter lead/QD, and quantity desired
CT _ TRIAC Switch with 5-meter lead, and quantity desired

T-NUT OPTION

TN _ Additional T-nuts and quantity

MOUNTING PLATES

MP _ Mounting Plates plus quantity desired

⚠ Not all codes listed are compatible with all options.

Use the Sizing Software to determine available options and accessories based on your application requirements.

📄 NOTE: MRB & MRV motors are discontinued contact Tolomatic for information on YMH (Your Motor Here)

| FIELD RETROFIT KITS | | |
|----------------------|-----------|-----------|
| ITEM | SLS10 | MLS10 |
| 1/4" Mounting Plates | 0610-9010 | 0610-9010 |
| 1/2" Mounting Plates | 0610-9045 | 0610-9045 |

Sold & Serviced By:

ELECTROMATE

Toll Free Phone (877) SERV098

Toll Free Fax (877) SERV099

www.electromate.com

sales@electromate.com