

Temposonics®

Magnetostrictive, Absolute, Non-contact
Linear-Position Sensors



E-Series Model EE Embedded Sensor Analog Output

Document Part Number:
551334 Revision A

Data Sheet

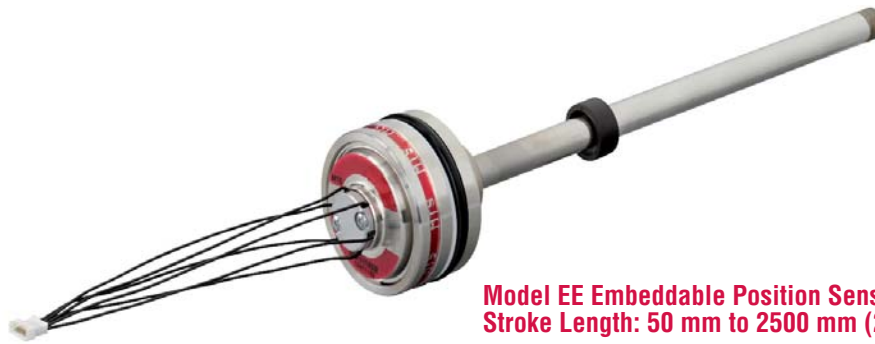

Model EE Embeddable Position Sensor
Stroke Length: 50 mm to 2500 mm (2 in. to 100 in.)

FEATURES

- Linear, Absolute Measurement
- Non-Contact Sensing Technology
- Linearity Less Than 0.02% F.S.
- Repeatability Less Than 0.002% F.S.
- Direct Analog Output:
 - 4 to 20 mA or 20 to 4 mA
 - Min/max. load 0/500 Ohms
- Stroke Length Range: 50 mm to 2500 mm (or 2 in. to 100 in.)

BENEFITS

- Compact Design for Embedded Cylinder Applications
- Continuous Absolute Position Measurement
- Over Voltage Protection to 36 Vdc and Polarity Protection up to -30 Vdc
- Increased Operating Temperature

APPLICATIONS

- Space Limited Cylinder Applications
- Embedded Continuous Position Measurement

TYPICAL INDUSTRIES

- Industrial Applications
- Fluid Power

Time-based Magnetostrictive position sensing principle

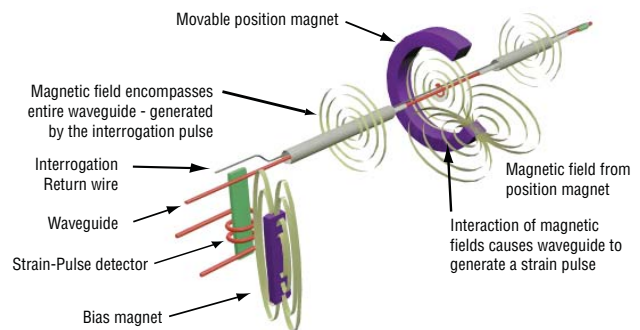

Benefits of Magnetostriction

Temposonics linear-position sensors use the time-based magnetostrictive position sensing principle developed by MTS. Within the sensing element, a sonic-strain pulse is induced in a specially designed magnetostrictive waveguide by the momentary interaction of two magnetic fields. One field comes from a movable permanent magnet that passes along the outside of the sensor. The other field comes from an “interrogation” current pulse applied along the waveguide. The resulting strain pulse travels at sonic speed along the waveguide and is detected at the head of the sensing element.

The position of the magnet is determined with high precision and speed by accurately measuring the elapsed time between the application of the interrogation pulse and the arrival of the resulting strain pulse with a high-speed counter. The elapsed time measurement is directly proportional to the position of the permanent magnet and is an absolute value. Therefore, the sensor’s output signal corresponds to absolute position, instead of incremental, and never requires recalibration or re-homing after a power loss. Absolute, non-contact sensing eliminates wear, and guarantees the best durability and output repeatability.

Sold & Serviced By:



Toll Free Phone (877) SERV098
Toll Free Fax (877) SERV099
www.electromate.com
sales@electromate.com

E-Series Model EE Embedded Sensor, Analog Output Product Overview and Specifications

Product overview

The Temposonics® E-Series embedded (EE) position sensor is designed to be embedded into a hydraulic cylinder. The compact sensor design makes the embeddable E-Series the perfect solution for small cylinders with limited space for the integration of a measuring system. The increased temperature range allows an operation of the sensor in high temperature industrial applications.

MTS Sensors continues to establish new performance standards for low-cost, fully-industrial, durable position sensors using the widely preferred magnetostrictive technology. This principle for accurate and non-contact measurement of linear-position sensing was developed 30 years ago by MTS and is used with outstanding success in a large variety of industrial applications.

Product specifications

Parameters	Specifications
OUTPUT	
Measured output variable:	Position
Resolution:	Analog: Infinite (restricted by output ripple)
Linearity deviation:	< ± 0.02% full stroke (minimum ± 60 µm)
Repeatability:	< ± 0.002% full stroke (minimum ± 20 µm)
Output:	Direct Analog / Current: 4 to 20 mA or 20 to 4 mA (Controller input resistance: RL ≤ 500 Ohms)
Stroke length:	Range: 50 mm to 2500 mm (or 2 to 100 in.)
Update Time:	≤ 3 kHz (Stroke length dependent)
ELECTRONICS	
Operating voltage:	+24 Vdc nominal: -15% or +20% Polarity protection: up to -30 Vdc Over voltage protection: up to 36 Vdc Current drain: 50 to 140 mA

Parameters	Specifications
ENVIRONMENTAL	
Operating conditions:	Operating temperature: -40 °C (-40 °F) to +85 °C (185 °F) Relative humidity: 90% no condensation Ingress protection: IP67 (With professionally mounted housing and connectors.) IP30 (Sensor with flat connector)
EMC test:	Electromagnetic emission: EN 55011, cl. B:2009 + A1:2010 Electromagnetic immunity: EN 61326-1:2006
Shock rating:	100 g (single shock) IEC-Standard 60068-2-27
Vibration rating:	15 g / 10 to 2000 Hz IEC-Standard 60068-2-6 (resonance frequencies excluded)
WIRING	
Connection types:	6-Pin Molex connector
ROD-STYLE SENSOR (MODEL EE)	
Electronic head:	Stainless Steel 1.4301 / AISI 304
Sensor rod:	Stainless Steel 1.4301 / AISI 304 10 mm rod: 350 bar static, 530 bar peak (5000 psi static, 7700 psi peak)
Mounting:	Any orientation. According to installation conditions.
Magnet types:	Ring magnet

Sold & Serviced By:



Toll Free Phone (877) SERV098
Toll Free Fax (877) SERV099
www.electromate.com
sales@electromate.com

Outputs

ANALOG (CURRENT) OUTPUT

The direct analog output range is 4 to 20 mA or 20 to 4 mA. Since the outputs are direct, no signal conditioning electronics are needed when interfacing with controllers or meters.

Analog output ranges:

- 4 to 20 mA
- 20 to 4 mA

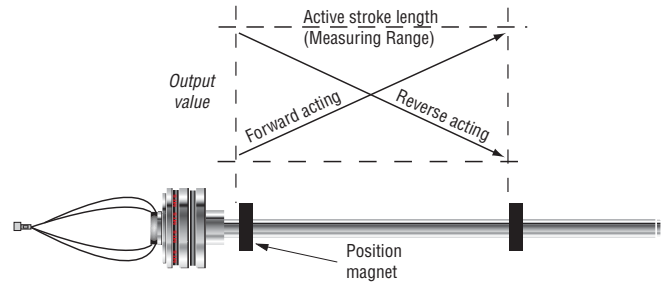

Figure 1. Analog Output signals

Sensor dimension references

Drawings are for reference only, contact applications engineering for tolerance specific information.

MODEL EE

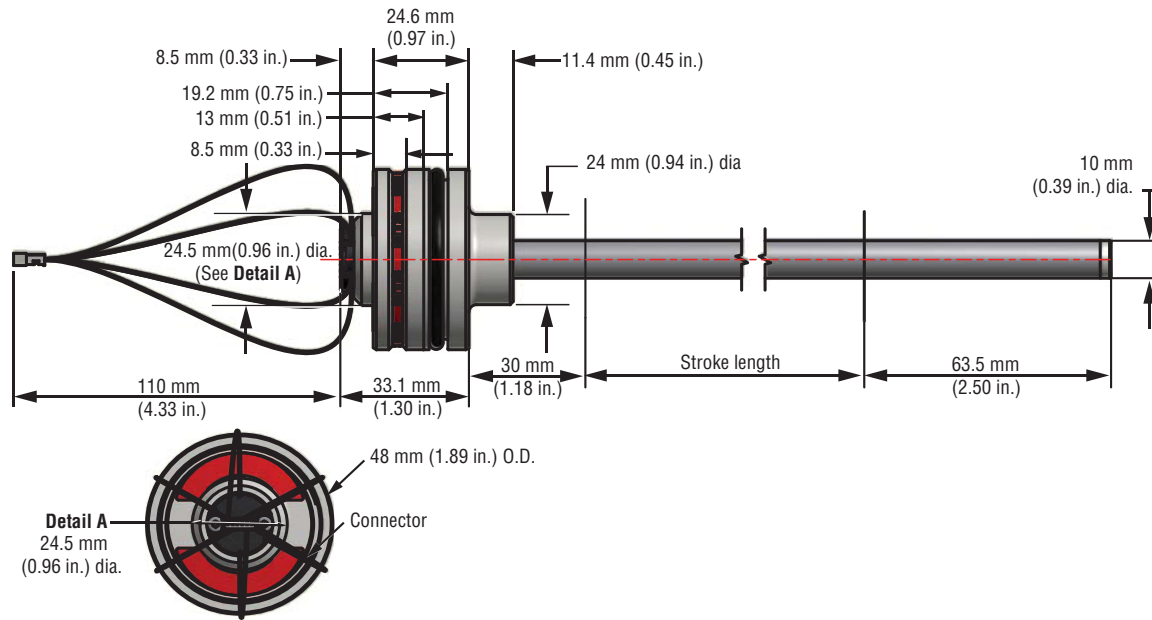

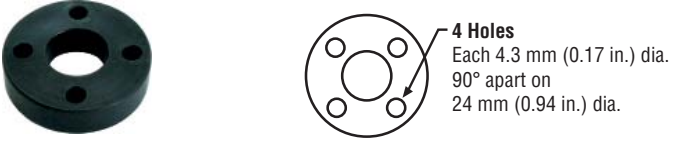
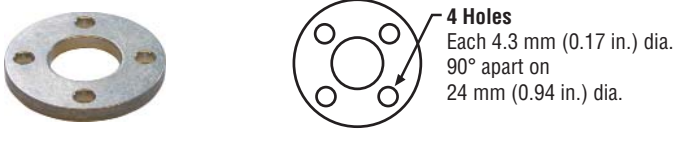

Figure 2. E-Series Model EE Sensor Component dimension reference

E-Series Model EE Embedded Sensor, Analog Output Magnet Options, Connections and Wiring

Standard magnet options (Model EE)

Magnets must be ordered separately with Model EE position sensors. The standard ring magnet (part number 201542-2) is suitable for most applications.

POSITION MAGNET SELECTIONS (Magnet must be ordered separately) (Drawing dimensions are for reference only)

Magnet and magnet dimensions	Description	Part number
 <p>4 Holes Each 4.3 mm (0.17 in.) dia. 90° apart on 24 mm (0.94 in.) dia.</p>	<p>Standard ring magnet I.D.: 13.5 mm (0.53 in.) O.D.: 33 mm (1.3 in.) Thickness: 8 mm (0.3 in.) Operating temperature: - 40 °C to +100 °C</p>	201542-2
 <p>4 Holes Each 4.3 mm (0.17 in.) dia. 90° apart on 24 mm (0.94 in.) dia.</p>	<p>Magnet spacer (Non-ferrous, use with ring magnet Part number: 201542-2) I.D.: 14 mm (0.56 in.) O.D.: 32 mm (1.25 in.) Thickness: 3.2 mm (0.125 in.)</p>	400633
	<p>Ring magnet I.D.: 13.5 mm (0.53 in.) O.D.: 17.4 mm (0.68 in.) Thickness: 8 mm (0.3 in.) Operating temperature: - 40 °C to 100 °C</p>	400533

Connections and wiring (Model EE)

MOLEX MATING CONNECTOR CABLE (M12) 5-PIN AND 6-PIN PINOUT/WIRING INFORMATION

The E-Series Model EE Sensor Component connects directly to a controller or interface module with the standard male, 5-pin or 6-pin connector and an extension cable as described in 'Table 1'

Analog (M12) 5-pin connector (male) as viewed from the face of the sensor plug

5-Pin connector	Molex Pin no.:	(M12) Pin no.:	Signal/function Analog outputs
	6	1	+24 Vdc
	3	2	Output signal
	4	3	DC ground (for power return)
	1	4	n.c.
	5	5	Ground for signal return
	2	-	n.c.

Table 1. M12 connector cable part no.: 254256

Sold & Serviced By:

 **ELECTROMATE**

Toll Free Phone (877) SERV098

Toll Free Fax (877) SERV099

www.electromate.com

sales@electromate.com

E-Series Model EE Embedded Sensor, Analog Output Cable and Connector Options

CABLE CONNECTOR OPTIONS FOR 5-PIN (M12) CONNECTOR TYPES *(Photo and drawing dimensions are for reference only)*

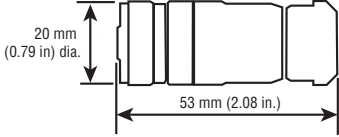
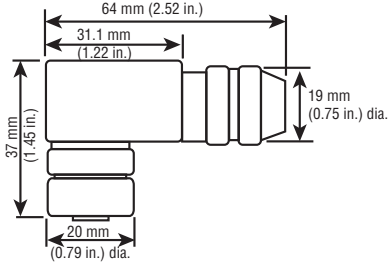
Connector and dimensions	Description	Part number
	<p>Female cable connector, straight exit (Field installable) 5-Pin (M12) Mates with 5-pin (M12) connector cable part no.: 254256 Sensor component output: Analog Termination: Screw terminals Cable gland: for 4-8 mm dia. cable Ingress protection: IP 67</p>	370677
	<p>Female cable connector, 90° exit (Field installable) 5-Pin (M12) Mates with 5-pin (M12) connector cable part no.: 254256 Sensor component output: Analog Termination: Screw terminals Cable gland: for 6 mm dia. cable Ingress protection: IP 67</p>	370678

MATING CABLE CONNECTOR SELECTIONS *(Drawing dimensions are for reference only)*

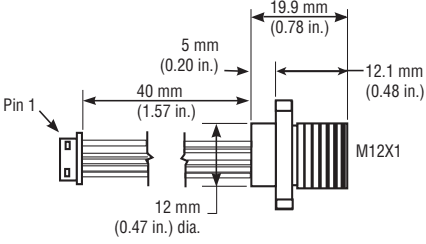
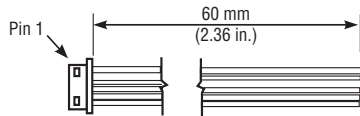
Connector and dimensions	Description	Part number
	<p>Mating cable connector 5-Pin (M12)</p>	254256
	<p>Pigtail mating connector</p>	254266

MATING CABLE CONNECTOR SELECTION *(Drawing dimensions are for reference only)*

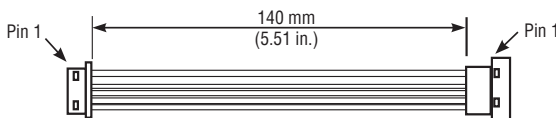
Connector and dimensions	Description	Part number
	<p>Extension cable, Molex to Molex</p>	254243

Sold & Serviced By:

 **ELECTROMATE**

Toll Free Phone (877) SERV098

Toll Free Fax (877) SERV099

www.electromate.com

sales@electromate.com

E-Series Model EE Embedded Sensor, Analog Output

Ordering Information

Use the order matrix below to configure your Model EE sensor order number.

E	E	S						M	0	0	1			
1	2	3	4	5	6	7	8	9	10	11	12	13	14	15

- SENSOR MODEL** _____ = **E E** 1 - 2
- EE** = E-Series Model EE rod-style sensor (Magnet must be ordered separately)
- ROD HOUSING AND FLANGE TYPE** _____ = **S** 3
- S** = Pressure fit housing, 10 mm OD rod
- STROKE LENGTH** _____ = 4 - 8
- M** = Millimeters (Encode in 5, 10, 25 or 50 mm increments) as indicated in 'Stroke length notes' below.
- U** = Inches (Encode in 0.2, 0.5, 1 or 2 in. increments) as indicated in 'Stroke length notes' below.

Stroke length Notes:	
Stroke length ranges:	
M = 50 mm to 2500 mm	
U = 2 in. to 100 in.	
The increment size between standard stroke lengths vary as shown below:	
Stroke length (mm)	Ordering increment
≤ 500 mm	5 mm
> 500 mm and ≤ 750 mm	10 mm
> 750 mm and ≤ 1000 mm	25 mm
> 1000 mm and ≤ 2500 mm	50 mm
Stroke length (in.)	Ordering increment
≤ 20 in.	0.2 in.
> 20 in. and ≤ 30 in.	0.5 in.
> 30 in. and ≤ 40 in.	1 in.
> 40 in. and ≤ 100 in.	2 in.

- SENSOR CONNECTION TYPE** _____ = **M 0 0** 9 - 11
- M00** = 6-Pin Molex, male
- INPUT VOLTAGE** _____ = **1** 12
- 1** = + 24 Vdc (+20%, -15%), standard
- OUTPUT CURRENT** _____ = 13 - 15
- A01** = 4 to 20 mA
- A11** = 20 to 4 mA