

LINEAR ROBOTICS

AUTOMATION COMPONENTS

MOTION ACCESSORIES

ABOUT MACRON

Macron Dynamics, Inc. is a manufacturer of linear robotic systems and mechanical motion components, providing automation solutions for applications found around the globe.

For more than 25 years, Macron has refined each component and every product through time-tested installations and experience. Macron products are built with the highest quality materials, assembled in the USA, and engineered to withstand the abuses of rigorous, daily usage. The result is a combination of versatility, positioning repeatability, durability, and virtually maintenance-free operation.

The trademarks of a Macron automation system include long travel capabilities, smooth, fast and repeatable belt driven motion, easy configuration, and extreme high quality.

ELECTROMATE
Toll Free Phone (877) SERV098
Toll Free Fax (877) SERV099
www.electromate.com
sales@electromate.com

LINEAR ROBOTICS

Motion so versatile, you won't believe it's linear. Available in 2 and 3 axis designs, Macron linear robotic systems are built to meet the specifications of any time, space, or size necessary to your unique application.

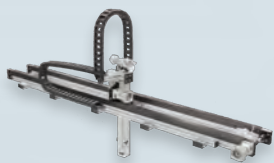

X/Z HD Robot

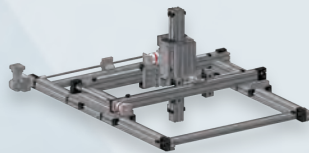

X/Y/Z Robot



H-Bot

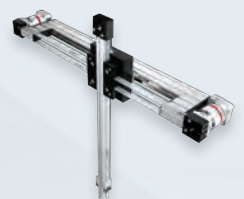

T-Bot

Our gantry and cartesian systems are available standard or configured to meet your specs. Motor mounting flexibility, cable management solutions, and plug and play functionality are just a few added bonuses to our proven experience in belt and screw driven technology.



AUTOMATION COMPONENTS

Belt Driven Actuators

Perfect for high-speed, heavy load applications, our aluminum belt driven actuator line is corrosion resistant, and designed with T-slots for easy mounting and a one-piece stress-proof shafted pulley.



MSA-PSC



MSA-14H



MSA-14S

Screw Driven Actuators

Simple and economical, our screw driven actuators are highly modifiable for different applications, and perfect for lightweight functionality.

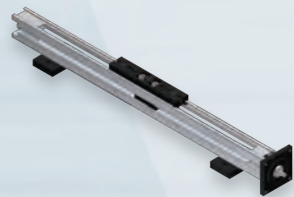

MSA-PSS

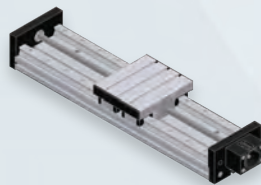

MSA-DRT

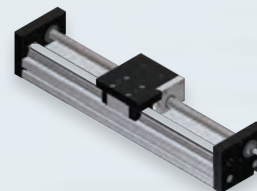

MSA-SRT

Sold & Serviced By:
ELECTROMATE
Toll Free Phone (877) SERV098
Toll Free Fax (877) SERV099
www.electromate.com
sales@electromate.com

MOTION ACCESSORIES

Macron Dynamics offers standard motion accessories to bring your automation system full circle and running at it's best. All MacSTANDARD belt-driven actuators come equipped with corresponding gearboxes and t-slot sensors, configured to your specifications.

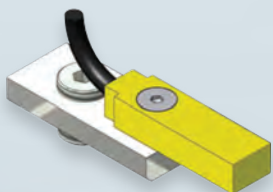

T-SLOT SENSOR



TENSIONING TOOLS



MAC-FRAME

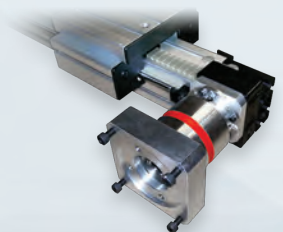

GEARBOXES



LINEAR ROBOTICS > T-BOT GANTRY ROBOTS

T-BOT GANTRY ROBOTS



TBG-25 OPTIONS

X AXIS TRAVEL (MM)

- 500
- 1000
- 2000
- Custom

Z AXIS TRAVEL (MM)

- 250
- 500
- Custom

Sold & Serviced By:
ELECTROMATE
 Toll Free Phone (877) SERV098
 Toll Free Fax (877) SERV099
www.electromate.com
sales@electromate.com

OPTIONS FOR:

- Controls
- Motor
- Gearbox

HOW TO BUILD YOUR TBG-25:

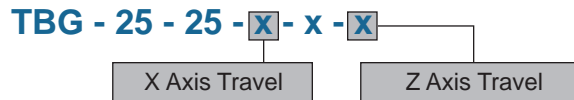

Features

- Fast and versatile belt driven 2 axis Pick & Place system
- One single belt drives both axes
- Two fixed motor mounting locations
- Fixed motors reduce load, cable management and inertia requirements
- Positional repeatability +/- .10 mm [.004 inches]
- Speeds up to 4 M/sec.
- Sealed linear profile rail and bearing guidance
- Mounting flexibility for a variety of end effectors

SPECIFICATIONS

Specifications	
Configuration	X/Z T-Bot
Belt Type	25
Maximum Load	50 lbs.
Standard X Travels	500 to 2000 mm
Standard Z Travels	250 to 500 mm



LINEAR ROBOTICS > X/Y/Z CARTESIAN GANTRIES

X/Y/Z CARTESIAN GANTRIES



MGS-14H OPTIONS

X AXIS TRAVEL (MM)

1000 2000 Custom

Y AXIS TRAVEL (MM)

1000 2000 Custom

Z AXIS TRAVEL (MM)

500 1000 Custom

Sold & Serviced By:
ELECTROMATE
Toll Free Phone (877) SERV098
Toll Free Fax (877) SERV099
www.electromate.com
sales@electromate.com

OPTIONS FOR:

Controls Motor Gearbox

Features

- The STANDARD in Cartesian X/Y/Z gantry robots based on the MSA-14H heavy duty actuator platform
- For programmable pick & place functionality and product mix flexibility the MGS-14S cannot be beat
- Positional repeatability +/- .05 mm [.002 inches]
- Speeds up to 2M/sec.
- The Macron Z axis belt driven actuator is robust and high speed yet forgiving
- Z axis is available with the Macron CLAWSTM Arresting system a patent pending free fall protection device
- Systems can be configured with MPG gearboxes or center drive gearboxes on special order
- Compatible with MacFRAME structural components
- Optional cable management solutions available

HOW TO BUILD YOUR HBG-25:

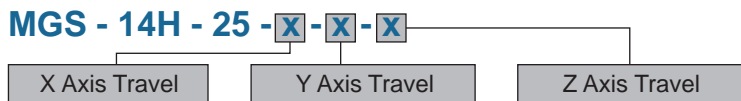

SPECIFICATIONS

Specifications	
Configuration	Dual X / Dual Y/Z
Belt Type	25
Maximum Load	200 lbs.
Standard X Travels	1000 or 2000 mm
Standard Y Travels	1000 or 2000 mm
Standard Z Travels	500 or 1000 mm



LINEAR ROBOTICS > X/Y GANTRY ROBOTS

X/Y GANTRY ROBOTS



MGS-14S OPTIONS

X AXIS TRAVEL (MM)

- 311
- 561
- 811
- 1061
- 1311
- 1561
- 1811
- Custom

Y AXIS TRAVEL (MM)

- 311
- 561
- 811
- 1061
- 1311
- 1561
- 1811
- Custom

Sold & Serviced By:
ELECTROMATE
 Toll Free Phone (877) SERV098
 Toll Free Fax (877) SERV099
www.electromate.com
sales@electromate.com

OPTIONS FOR:

Controls Motor Gearbox

Features

- Flexible X/Y Gantry system built on workhorse MSA-14 actuator platform
- Standard travel options for rapid delivery and system application matching
- Positional repeatability +/- .05 mm [.002 inches]
- Speeds up to 3M/sec.
- Motor mounting orientation flexibility
- Can be configured with MPG gearboxes
- Vertical or Horizontal mounting capability
- Compatible with MacFRAME structural components
- Optional cable management solutions available

HOW TO BUILD YOUR MGS-14S:

MGS - 14S - 25 - X - X - X



SPECIFICATIONS

Specifications	
Configuration	Dual X/Y
Belt Type	25
Maximum Load	150 lbs.
Standard X Travels	311 to 1811 mm
Standard Z Travels	311 to 1811 mm



LINEAR ROBOTICS > H-BOT GANTRY ROBOTS

H-BOT GANTRY ROBOTS



HBG-25 OPTIONS

X AXIS TRAVEL (MM)

- 500
- 1000
- 2000
- Custom

Y AXIS TRAVEL (MM)

- 500
- 1000
- Custom

Sold & Serviced By:
ELECTROMATE
 Toll Free Phone (877) SERV098
 Toll Free Fax (877) SERV099
 www.electromate.com
 sales@electromate.com

OPTIONS FOR:

- Controls
- Motor
- Gearbox

HOW TO BUILD YOUR HBG-25:

HBG - 25 - 25 - X - X - X



Features

- H-Bot configuration
- High speed, high performance 2 axis Cartesian robot
- Simple design: One single belt drives both axes
- Two fixed motor mounting locations
- Fixed motors reduce load, cable management and inertia requirements
- Positional repeatability +/- .10 mm [.004 inches]
- Sealed linear profile rail and bearing guidance
- Low profile
- Mounting flexibility in either horizontal or vertical orientation

SPECIFICATIONS

Specifications	
Configuration	X/Y H-Bot
Belt Type	25
Maximum Load	50 lbs.
Standard X Travels	500 to 2000 mm
Standard Z Travels	500 to 1000 mm



LINEAR ROBOTICS > X/Z HEAVY DUTY GANTRY ROBOTS > MGS-UC1

MGS-UC1



MGS-UC1 OPTIONS

X AXIS NOMINAL STANDARD TRAVEL (MM)

- 1000
- 1500
- 2000
- 2500
- 3000
- 3500
- 4000
- 4500
- 5000
- 5250
- Custom

Z AXIS NOMINAL STANDARD TRAVEL (MM)

- 250
- 500
- Custom

Sold & Serviced By:
ELECTROMATE
 Toll-Free Phone (877) SERV098
 Toll-Free Fax (877) SERV099
www.electromate.com
sales@electromate.com

OPTIONS FOR:

Sensors Gearbox Ratios

HOW TO BUILD YOUR MGS-UC1:

MGS - UC1 - X - X - X



Note: See mounting notes below for mounting relationship to payloads.

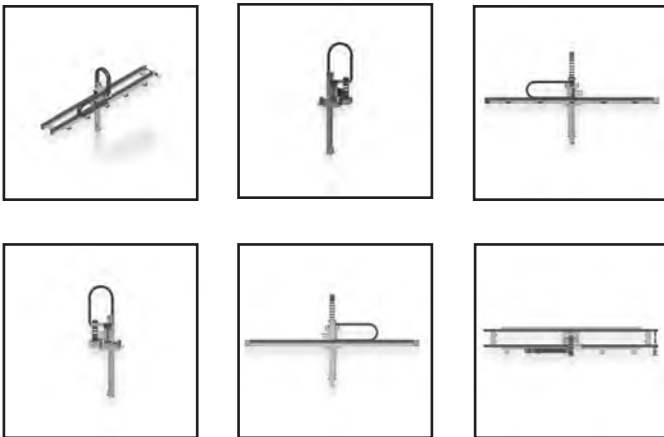



LINEAR ROBOTICS > X/Z HEAVY DUTY GANTRY ROBOTS > MGS-UC1

MGS-UC1

MOUNTING NOTES AND PAYLOAD RELATIONSHIP TABLE

X Axis Travels (mm)	Mounting Style	Acceptable Payload (lbs)
1000	'X' Axis Beams Mounted At Ends of Actuators	275
1500		190
2000		105
2500		20
3000	'X' Axis Beams Require Supporting Structure Over Actuator Length	275
4000		
4500		
5000		
5250		

SPECIFICATIONS

Specifications	
Maximum Speed - mm/sec - X Axis [Z Axis]	5080 [10160]
Unsupported X Axis Travels - mm (in steps of 500mm)	1000 to 2500
Unsupported Payload - lbs. (Dependant on X Axis travel)	275 to 20
Supported X Axis Travels - mm (in steps of 500mm)	3000 to 5500
Maximum Payload - lbs.	275
Z Axis Travels - mm (in steps of 250mm)	250 to 500
Repeatability - mm	+/-0.025
Positional Accuracy - mm / meter	+/-0.4
Acceleration Max. - G's (dependant on payload)	1 to 10

SPECIFICATIONS

Motor Sizing Information	
Weight of single shafted 40-25 drive pulley- 11.3oz.	X & Z axis
Weight of double shafted 40-25 drive pulley- 17oz.	X axis
Weight of 40-25 idler pulley - 7.7oz.	X axis
Weight of single shafted 40-50 drive pulley- 28.4oz.	N/A
Weight of 40-50 idler pulley - 26.4oz.	N/A
Weight of Z Axis Beam - lbs. (dependant on travel)	16.5 to 30
Weight of Complete Z Axis - lbs. (dependant on travel)	31.5 to 45
Travel per Revolution - mm	150
Pulley Pitch Diameter - mm	47.74
Pulley Material / Width - mm	steel / 25
Rolling Resistance - lbs. (worst case with max payload)	0.32
Weight	
Weight - lbs. (dependant on travels)	91.5 to 135
Sizing - See mounting notes and payload relationship table for guidance	
X Axis Nominal Length Standard Unsupported - m	**2.5
X Axis Nominal Standard Travels - mm	*1000 to 5250
Z Axis Nominal Standard Travels - mm	*250 to 500
* note: axes may be configured in lengths shorter or longer than standard ** note: for legnth longer than standard contact Macron for a MacBUILT option	





LINEAR ROBOTICS > X/Z HEAVY DUTY GANTRY ROBOTS > MGS-UC2

MGS-UC2



MGS-UC2 OPTIONS

X AXIS NOMINAL STANDARD TRAVEL (MM)

- 1000
- 1500
- 2000
- 2500
- 3000
- 3500
- 4000
- 4500
- 5000
- 5250
- Custom

Z AXIS NOMINAL STANDARD TRAVEL (MM)

- 250
- 500
- Custom

Sold & Serviced By:
ELECTROMATE
 Toll Free Phone (877) SERV098
 Toll Free Fax (877) SERV099
www.electromate.com
sales@electromate.com

OPTIONS FOR:

Sensors Gearbox Ratios

HOW TO BUILD YOUR MGS-UC2:

MGS - UC2 - X - X - X



Note: See mounting notes below for mounting relationship to payloads.

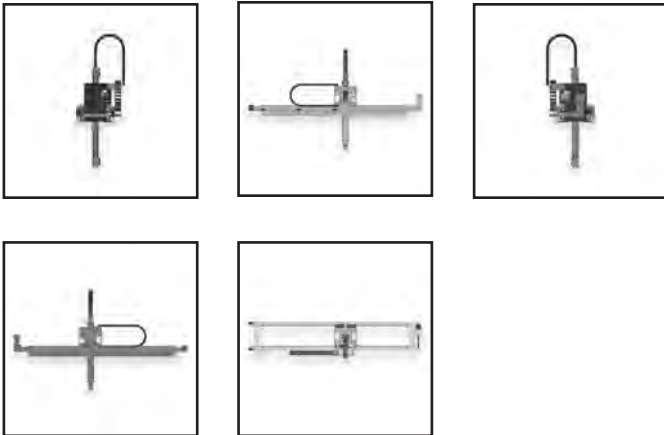



LINEAR ROBOTICS > X/Z HEAVY DUTY GANTRY ROBOTS > MGS-UC2

MGS-UC2

MOUNTING NOTES AND PAYLOAD RELATIONSHIP TABLE

X Axis Travels (mm)	Mounting Style	Acceptable Payload (lbs)
1000	'X' Axis Beams Mounted At Ends of Actuators	700
1500		530
2000		360
2500		190
3000		20
4000	'X' Axis Beams Require Supporting Structure Over Actuator Length	700
4500		
5000		
5250		

SPECIFICATIONS

Specifications

Maximum Speed - mm/sec - X Axis [Z Axis]	10160 [10160]
Unsupported X Axis Travels - mm (in steps of 500mm)	1000 to 3000
Unsupported Payload - lbs. (Dependant on X Axis travel)	700 to 20
Supported X Axis Travels - mm (in steps of 500mm)	3500 to 5250
Maximum Payload - lbs.	700
Z Axis Travels - mm (in steps of 250mm)	250 to 500
Repeatability - mm	+/-0.025
Positional Accuracy - mm / meter	+/-0.4
Acceleration Max. - G's (dependant on payload)	1 to 4

SPECIFICATIONS

Motor Sizing Information

Weight of single shafted 40-25 drive pulley- 11.3oz.	X axis
Weight of double shafted 40-25 drive pulley- 17oz.	N/A
Weight of 40-25 idler pulley - 7.7oz.	X axis
Weight of single shafted 40-50 drive pulley- 28.4oz.	Z axis
Weight of 40-50 idler pulley - 26.4oz.	N/A
Weight of Z Axis Beam - lbs. (dependant on travel)	26 to 32
Weight of Complete Z Axis - lbs. (dependant on travel)	145 to 154
Travel per Revolution - mm	150
Pulley Pitch Diameter - mm	47.74
Pulley Material / Width - mm	steel / 25 & 50
Rolling Resistance - lbs. (worst case with max payload)	0.85
Weight	
Weight - lbs. (dependant on travels)	200 to 403
Sizing - See mounting notes and payload relationship table for guidance	
X Axis Nominal Length Standard Unsupported - m	**3
X Axis Nominal Standard Travels - mm	*1000 to 5250
Z Axis Nominal Standard Travels - mm	*250 to 500

Sold & Serviced By:
ELECTROMATE
 Toll Free Phone (877) SERV098
 Toll Free Fax (877) SERV099
 www.electromate.com
 sales@electromate.com

* note: axes may be configured in lengths shorter or longer than standard
 ** note: for lengths longer than standard contact Macron for a MacBUILT option

Macron Solutions Since 1987

MACRON DYNAMICS, INC.
 100 Phyllis Drive
 Croydon, PA 19021
 © 2014 MACRON DYNAMICS, INC.

1-800-MACRON-1 (1-800-622-7661)
 Phone: 267-557-3590
 Fax: 215-443-0981

Macron Guarantee

All Macron actuators and belt drives are covered by our
 1-Year Warranty



LINEAR ROBOTICS > X/Z HEAVY DUTY GANTRY ROBOTS > MGS-UC3

MGS-UC3



MGS-UC3 OPTIONS

X AXIS NOMINAL STANDARD TRAVEL (MM)

- 1000
- 1500
- 2000
- 2500
- 3000
- 3500
- 4000
- 4500
- 4750
- Custom

Z AXIS NOMINAL STANDARD TRAVEL (MM)

- 250
- 500
- 750
- Custom

OPTIONS FOR:

Sensors Gearbox Ratios

Sold & Serviced By:
ELECTROMATE
 Toll Free Phone (877) SERV098
 Toll Free Fax (877) SERV099
www.electromate.com
sales@electromate.com

HOW TO BUILD YOUR MGS-UC3:

MGS - UC3 - **X** - x - **X**



Note: See mounting notes below for mounting relationship to payloads.

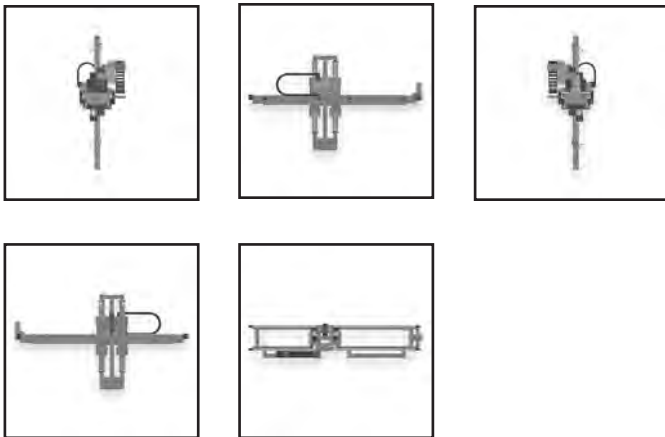

Macron Solutions Since 1987

MACRON DYNAMICS, INC. 1-800-MACRON-1 (1-800-622-7661)
 100 Phyllis Drive Phone: 267-557-3590
 Croydon, PA 19021 Fax: 215-443-0981
 © 2014 MACRON DYNAMICS, INC.

Macron Guarantee

All Macron actuators and belt drives are covered by our
 1-Year Warranty



LINEAR ROBOTICS > X/Z HEAVY DUTY GANTRY ROBOTS > MGS-UC3

MGS-UC3

MOUNTING NOTES AND PAYLOAD RELATIONSHIP TABLE

X Axis Travels (mm)	Mounting Style	Acceptable Payload (lbs)
1000	'X' Axis Beams Mounted At Ends of Actuators	1400
1500		950
2000		500
2500		50
3000	'X' Axis Beams Require Supporting Structure Over Actuator Length	1400
4000		
4500		
5000		
5250		

SPECIFICATIONS

Specifications

Maximum Speed - mm/sec - X Axis [Z Axis]	10161 [10161]
Unsupported X Axis Travels - mm (in steps of 500mm)	1000 to 2500
Unsupported Payload - lbs. (Dependant on X Axis travel)	1400 to 50
Supported X Axis Travels - mm (in steps of 500mm)	3000 to 4750
Maximum Payload - lbs.	1400
Z Axis Travels - mm (in steps of 250mm)	250 to 750
Repeatability - mm	+/-0.025
Positional Accuracy - mm / meter	+/-0.4
Acceleration Max. - G's (dependant on payload)	1 to 2

SPECIFICATIONS

Motor Sizing Information

Weight of single shafted 40-25 drive pulley- 11.3oz.	X axis
Weight of double shafted 40-25 drive pulley- 17oz.	N/A
Weight of 40-25 idler pulley - 7.7oz.	X axis
Weight of single shafted 40-50 drive pulley- 28.4oz.	Z axis
Weight of 40-50 idler pulley - 26.4oz.	N/A
Weight of Z Axis Beam - lbs. (dependant on travel)	108 to 138
Weight of Complete Z Axis - lbs. (dependant on travel)	343 to 373
Travel per Revolution - mm	150
Pulley Pitch Diameter - mm	47.74
Pulley Material / Width - mm	steel / 25 & 50
Rolling Resistance - lbs. (worst case with max payload)	1.8
Weight	
Weight - lbs. (dependant on travels)	544 to 844
Sizing - See mounting notes and payload relationship table for guidance	
X Axis Nominal Length Standard Unsupported - m	**2.5
X Axis Nominal Standard Travels - mm	*1000 to 4750
Z Axis Nominal Standard Travels - mm	*250 to 750
* note: axes may be configured in lengths shorter or longer than standard	
** note: for lengths longer than standard contact Macron for a MacBUILT option	

Sold & Serviced By:
ELECTROMATE
 Toll Free Phone (877) SERV098
 Toll Free Fax (877) SERV099
 www.electromate.com
 sales@electromate.com

Macron Solutions Since 1987

MACRON DYNAMICS, INC.
 100 Phyllis Drive
 Croydon, PA 19021
 © 2014 MACRON DYNAMICS, INC.

1-800-MACRON-1 (1-800-622-7661)
 Phone: 267-557-3590
 Fax: 215-443-0981

Macron Guarantee

All Macron actuators and belt drives are covered by our
 1-Year Warranty



LINEAR ROBOTICS > X/Z HEAVY DUTY GANTRY ROBOTS > MGS-UC4

MGS-UC4

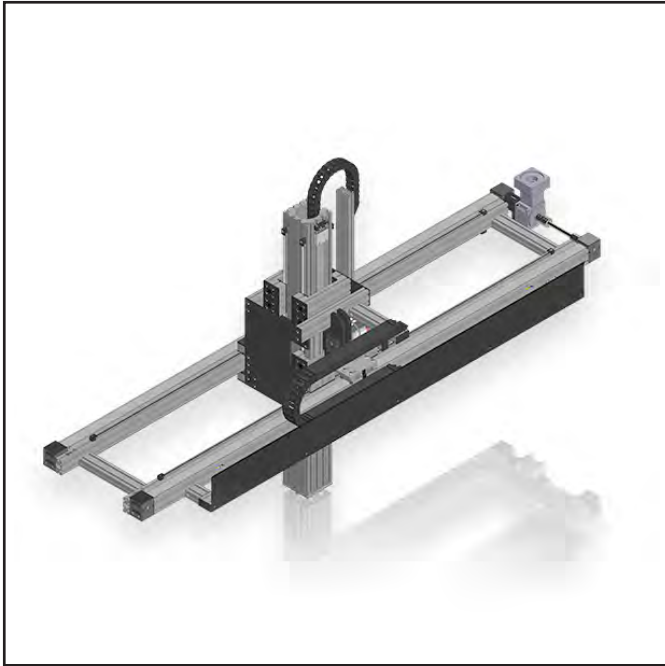

MGS-UC4 OPTIONS

X AXIS NOMINAL STANDARD TRAVEL (MM)

- 1000
- 1500
- 2000
- 2500
- 3000
- 3250
- Custom

Z AXIS NOMINAL STANDARD TRAVEL (MM)

- 250
- 500
- 750
- 1000
- Custom

OPTIONS FOR:

Sensors Gearbox Ratios

Sold & Serviced By:
ELECTROMATE
 Toll Free Phone (877) SERV098
 Toll Free Fax (877) SERV099
 www.electromate.com
 sales@electromate.com

HOW TO BUILD YOUR MGS-UC4:

MGS - UC4 - **X** - x - **X**



Note: See mounting notes below for mounting relationship to payloads.

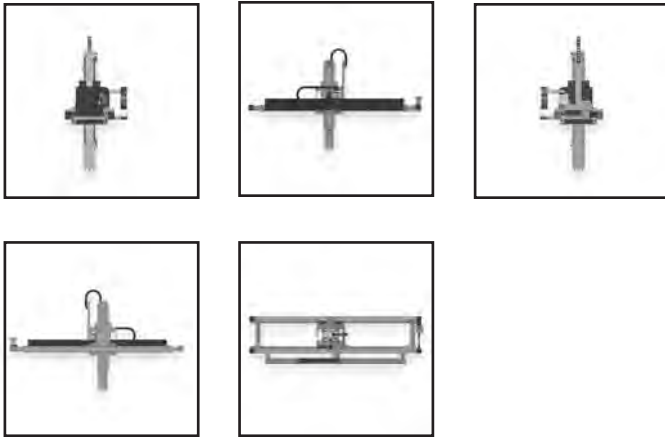

Macron Solutions Since 1987

MACRON DYNAMICS, INC. 1-800-MACRON-1 (1-800-622-7661)
 100 Phyllis Drive Phone: 267-557-3590
 Croydon, PA 19021 Fax: 215-443-0981
 © 2014 MACRON DYNAMICS, INC.

Macron Guarantee

All Macron actuators and belt drives are covered by our
 1-Year Warranty



LINEAR ROBOTICS > X/Z HEAVY DUTY GANTRY ROBOTS > MGS-UC4

MGS-UC4

MOUNTING NOTES AND PAYLOAD RELATIONSHIP TABLE

X Axis Travels (mm)	Mounting Style	Acceptable Payload (lbs)
1000	'X' Axis Beams Mounted At Ends of Actuators	400
1500		20
2000		'X' Axis Beams Require Supporting Structure Over Actuator Length
2500		
3000		
3250		

SPECIFICATIONS

Specifications	
Maximum Speed - mm/sec - X Axis [Z Axis]	10162 [10160]
Unsupported X Axis Travels - mm (in steps of 500mm)	1000 to 1500
Unsupported Payload - lbs. (Dependant on X Axis travel)	400 to 20
Supported X Axis Travels - mm (in steps of 500mm)	2000 to 3250
Maximum Payload - lbs.	600
Z Axis Travels - mm (in steps of 250mm)	250 to 1000
Repeatability - mm	+/-0.025
Positional Accuracy - mm / meter	+/-0.4
Acceleration Max. - G's (dependant on payload)	1 to 2

SPECIFICATIONS

Motor Sizing Information

Weight of single shafted 40-25 drive pulley- 11.3oz.	N/A
Weight of double shafted 40-25 drive pulley- 17oz.	N/A
Weight of 40-25 idler pulley - 7.7oz.	N/A
Weight of single shafted 40-50 drive pulley- 28.4oz.	X & Z axis
Weight of 40-50 idler pulley - 26.4oz.	X axis
Weight of Z Axis Beam - lbs. (dependant on travel)	58 to 100
Weight of Complete Z Axis - lbs. (dependant on travel)	224 to 266
Travel per Revolution - mm	150
Pulley Pitch Diameter - mm	47.74
Pulley Material / Width - mm	steel / 50
Rolling Resistance - lbs. (worst case with max payload)	0.86

Sold & Serviced By:
ELECTROMATE
 Toll Free Phone (877) SERV098
 Toll Free Fax (877) SERV099
 www.electromate.com
 sales@electromate.com

Weight

Weight - lbs. (dependant on travels)	385 to 535
--------------------------------------	-------------------

Sizing - See mounting notes and payload relationship table for guidance

X Axis Nominal Length Standard Unsupported - m	**1.5
X Axis Nominal Standard Travels - mm	*1000 to 3250
Z Axis Nominal Standard Travels - mm	*250 to 1000

* note: axes may be configured in lengths shorter or longer than standard
 ** note: for lengths longer than standard contact Macron for a MacBUILT option

Macron Solutions Since 1987

MACRON DYNAMICS, INC.
 100 Phyllis Drive
 Croydon, PA 19021
 © 2014 MACRON DYNAMICS, INC.

1-800-MACRON-1 (1-800-622-7661)
 Phone: 267-557-3590
 Fax: 215-443-0981

Macron Guarantee

All Macron actuators and belt drives are covered by our
 1-Year Warranty



LINEAR ROBOTICS > DUAL X/Y GANTRY ROBOTS

DUAL X/Y GANTRY ROBOTS



MGS-14L OPTIONS

X AXIS TRAVEL (MM)

- 264
- 514
- 764
- 1014
- 1264
- 1514
- Custom

Y AXIS TRAVEL (MM)

- 311
- 561
- 811
- 1061
- 1311
- 1561
- 1811
- Custom

OPTIONS FOR:

Controls Motor Gearbox

Sold & Serviced By:
ELECTROMATE
 Toll Free Phone (877) SERV098
 Toll Free Fax (877) SERV099
 www.electromate.com
 sales@electromate.com

HOW TO BUILD YOUR MGS-14L:

MGS - 14L - 25 - X - X - X



Features

- Flexible dual X dual Y Gantry system built on workhorse MSA-14 actuator platform
- Standard travel options for rapid delivery and system application matching
- Dual axis increases load handling capacity
- Long carts provide higher moment load capability
- Positional repeatability +/- .05 mm [.002 inches]
- Speeds up to 3M/sec.
- Motor mounting orientation flexibility
- Can be configured with MPG gearboxes
- Vertical or Horizontal mounting capability
- Compatible with MacFRAME structural components
- Optional cable management solutions available

SPECIFICATIONS

Specifications	
Configuration	Dual X Dual Y
Belt Type	25
Maximum Load	300 lbs.
Standard X Travels	264 to 1514 mm
Standard Z Travels	311 to 1811 mm

Macron Solutions Since 1987

MACRON DYNAMICS, INC. 1-800-MACRON-1 (1-800-622-7661)
 100 Phyllis Drive Phone: 267-557-3590
 Croydon, PA 19021 Fax: 215-443-0981
 © 2014 MACRON DYNAMICS, INC.

Macron Guarantee

All Macron actuators and belt drives are covered by our
 1-Year Warranty



BELT DRIVEN ACTUATORS > MSA-14S ACTUATOR

MSA-14S ACTUATOR



MSA-14S OPTIONS

SHAFT TYPE

- Single
- Double

DRIVE SHAFT LOCATION

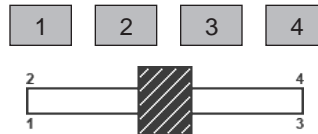

TRAVELS

(Min 150mm - Max 5650mm)

Sold & Serviced By:
ELECTROMATE
 Toll Free Phone (877) SERV098
 Toll Free Fax (877) SERV099
 www.electromate.com
 sales@electromate.com

OPTIONS FOR:

- Motor Mounting
- Sensors
- Gearbox



HOW TO BUILD YOUR MSA-14S:



Note: See mounting notes below for mounting relationship to payloads.

Macron Solutions Since 1987

MACRON DYNAMICS, INC.
 100 Phyllis Drive
 Croydon, PA 19021

1-800-MACRON-1 (1-800-622-7661)
 Phone: 267-557-3590
 Fax: 215-443-0981

© 2014 MACRON DYNAMICS, INC.

Macron Guarantee

All Macron actuators and belt drives are covered by our
 1-Year Warranty



BELT DRIVEN ACTUATORS > MSA-14S ACTUATOR

MSA-14S ACTUATOR

SPECIFICATIONS

Specifications

Motion	Horizontal or Vertical
Max Speed - horizontal [vertical] - mm / sec	10160 [5080]
Max Load - horizontal [vertical] - lbs.	200 [100]
Repeatability - mm	+/-0.025
Moment Load Max - in. - lbs. [Nm]	230 [26]
Positional Accuracy - mm / meter	+/- 0.4
Acceleration max - G's	9
Beam Dimensions - mm	80 x 80
Motor Sizing Information	
Weight of Drive Pulley - oz. / kgs.	11.3 / 0.32
Weight of Idler Pulley - oz. / kgs.	7.7 / 0.22
Weight of Cart - lbs. / kgs.	7.8 / 3.54
Weight of Belt - kgs. based on travel selected	((Travel in meters x 2) + 0.47) x 0.12
Travel per Revolution - mm	150
Pulley Pitch Diameter - mm	47.74
Pulley Material / Width - mm	steel / 25
Breakaway Torque - oz. - in.	42-44
Coefficient Friction	N/A
Rolling Resistance - lbs. / kgs.	0.018 / 0.008

SPECIFICATIONS

Weight

Weight - min. travel unit (150 mm) - lbs. / kgs.	21.4 / 9.7
Weight - additional 25 mm of travel - lbs. / kgs.	0.49 / 0.22

Travels

Standard Travels - min max - mm (25 mm increment)	150 / 5650
---	-------------------

Features

- Extruded aluminum actuator body with T-slots for ease of mounting
- Easy to adjust belt tensioner
- One piece, machined and stress proof shafted pulley
- Zero backlash belt to pulley design
- Corrosion resistant components

Sold & Serviced By:

 (877) SERV098
 Toll Free Fax (877) SERV099
 www.electromate.com
 sales@electromate.com

Macron Solutions Since 1987

MACRON DYNAMICS, INC.
 100 Phyllis Drive
 Croydon, PA 19021
 © 2014 MACRON DYNAMICS, INC.

1-800-MACRON-1 (1-800-622-7661)
 Phone: 267-557-3590
 Fax: 215-443-0981

Macron Guarantee

All Macron actuators and belt drives are covered by our
 1-Year Warranty



BELT DRIVEN ACTUATORS > MSA-14H ACTUATOR

MSA-14H ACTUATOR



MSA-14H OPTIONS

SHAFT TYPE

- Single
- Double

DRIVE SHAFT LOCATION

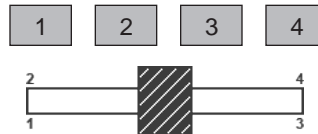

TRAVELS

(Min 150mm - Max 5625mm)

Sold & Serviced By:
ELECTROMATE
 Toll Free Phone (877) SERV098
 Toll Free Fax (877) SERV099
 www.electromate.com
 sales@electromate.com

OPTIONS FOR:

- Motor Mounting
- Sensors
- Gearbox

HOW TO BUILD YOUR MSA-14H:



Note: See mounting notes below for mounting relationship to payloads.

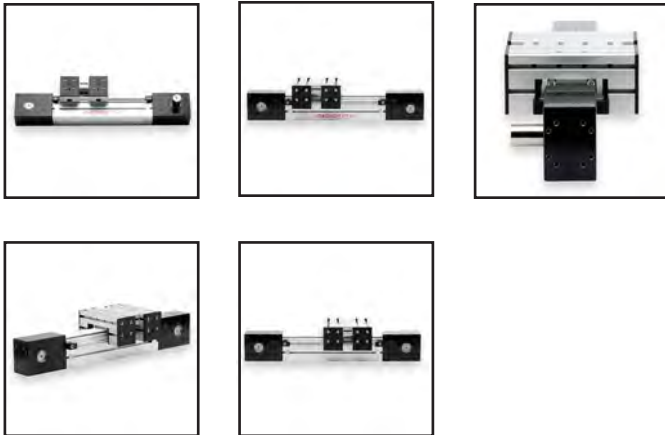

Macron Solutions Since 1987

MACRON DYNAMICS, INC. 1-800-MACRON-1 (1-800-622-7661)
 100 Phyllis Drive Phone: 267-557-3590
 Croydon, PA 19021 Fax: 215-443-0981
 © 2014 MACRON DYNAMICS, INC.

Macron Guarantee

All Macron actuators and belt drives are covered by our
 1-Year Warranty



BELT DRIVEN ACTUATORS > MSA-14H ACTUATOR

MSA-14H ACTUATOR

SPECIFICATIONS

Specifications

Motion	Horizontal or Vertical
Max Speed - horizontal [vertical] - mm / sec	10160 [5080]
Max Load - horizontal [vertical] - lbs.	400 [300]
Repeatability - mm	+/-0.025
Moment Load Max - in. - lbs. [Nm]	460 [52]
Positional Accuracy - mm / meter	+/- 0.4
Acceleration max - G's	9
Beam Dimensions - mm	98 x 80
Motor Sizing Information	
Weight of Drive Pulley - oz. / kgs.	28.4 / 0.81
Weight of Idler Pulley - oz. / kgs.	26.4 / 0.75
Weight of Cart - lbs. / kgs.	12.0 / 5.44
Weight of Belt - kgs. based on travel selected	((Travel in meters x 2) + 0.84) x 0.35
Travel per Revolution - mm	280
Pulley Pitch Diameter - mm	89.13
Pulley Material / Width - mm	steel / 50
Breakaway Torque - oz. - in.	196-200
Coefficient Friction	N/A
Rolling Resistance - lbs. / kgs.	0.032 / 0.014

SPECIFICATIONS

Weight

Weight - min. travel unit (150 mm) - lbs. / kgs.	60.5 / 27.4
Weight - additional 25 mm of travel - lbs. / kgs.	0.58 / 0.26

Travels

Standard Travels - min max - mm (25 mm increment)	150 / 5625
---	-------------------

Features

- Extruded aluminum actuator body with T-slots for easy mounting
- Easy to adjust belt tensioner
- One piece, machined and stress proof shafted pulley
- Zero backlash belt to pulley design
- Corrosion resistant components

Sold & Serviced By:

 Phone (877) SERV098
 Toll Free Fax (877) SERV099
 www.electromate.com
 sales@electromate.com

Macron Solutions Since 1987

MACRON DYNAMICS, INC.
 100 Phyllis Drive
 Croydon, PA 19021
 © 2014 MACRON DYNAMICS, INC.

1-800-MACRON-1 (1-800-622-7661)
 Phone: 267-557-3590
 Fax: 215-443-0981

Macron Guarantee

All Macron actuators and belt drives are covered by our
 1-Year Warranty



BELT DRIVEN ACTUATORS > MSA-PSC ACTUATOR

MSA-PSC ACTUATOR



MSA-PSC OPTIONS

SHAFT TYPE

- Single
- Double

DRIVE SHAFT LOCATION

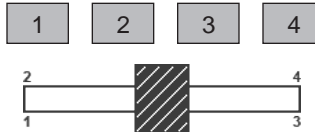

TRAVELS

(Min 150mm - Max 5350mm)

Sold & Serviced By:
ELECTROMATE
 Toll Free Phone (877) SERV098
 Toll Free Fax (877) SERV099
 www.electromate.com
 sales@electromate.com

OPTIONS FOR:

- Motor Mounting
- Sensors
- Gearbox

HOW TO BUILD YOUR MSA-PSC:

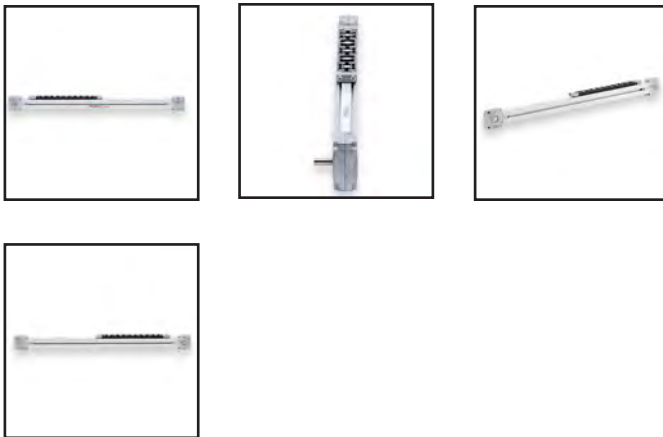

Macron Solutions Since 1987

MACRON DYNAMICS, INC. 1-800-MACRON-1 (1-800-622-7661)
 100 Phyllis Drive Phone: 267-557-3590
 Croydon, PA 19021 Fax: 215-443-0981
 © 2014 MACRON DYNAMICS, INC.

Macron Guarantee

All Macron actuators and belt drives are covered by our
 1-Year Warranty



BELT DRIVEN ACTUATORS > MSA-PSC ACTUATOR

MSA-PSC ACTUATOR

SPECIFICATIONS

Specifications

Motion	Horizontal or Vertical
Max Speed - horizontal [vertical] - mm / sec	1270 [635]
Max Load - horizontal [vertical] - lbs.	20 [20]
Repeatability - mm	+/-0.025
Moment Load Max - in. - lbs. [Nm]	15 [1.7]
Positional Accuracy - mm / meter	+/- 0.4
Acceleration max - G's	5
Beam Dimensions - mm	28 x 38
Motor Sizing Information	
Weight of Drive Pulley - oz. / kgs.	4.7 / 0.13
Weight of Idler Pulley - oz. / kgs.	4.3 / 0.12
Weight of Cart - lbs. / kgs.	0.4 / 0.18
Weight of Belt - kgs. based on travel selected	((Travel in meters x 2) + 0.32) x 0.04
Travel per Revolution - mm	105
Pulley Pitch Diameter - mm	33.42
Pulley Material / Width - mm	steel / 12
Breakaway Torque - oz. - in.	12-14
Coefficient Friction	0.25
Rolling Resistance - lbs. / kgs.	N/A

SPECIFICATIONS

Weight

Weight - min. travel unit (150 mm) - lbs. / kgs.	3.5 / 1.6
Weight - additional 25 mm of travel - lbs. / kgs.	0.08 / 0.04
Travels	
Standard Travels - min max - mm (25 mm increment)	150 / 5350

Features

- Extruded aluminum actuator body with T-slots for easy mounting
- Easy to adjust belt tensioner
- One piece, machined and stress proof shafted pulley
- Zero backlash belt to pulley design
- Corrosion resistant components

Sold & Serviced By:
ELECTROMATE
 Toll Free Phone (877) SERV098
 Toll Free Fax (877) SERV099
 www.electromate.com
 sales@electromate.com

Macron Solutions Since 1987

MACRON DYNAMICS, INC.
 100 Phyllis Drive
 Croydon, PA 19021
 © 2014 MACRON DYNAMICS, INC.

1-800-MACRON-1 (1-800-622-7661)
 Phone: 267-557-3590
 Fax: 215-443-0981

Macron Guarantee

All Macron actuators and belt drives are covered by our
 1-Year Warranty



BELT DRIVEN ACTUATORS > MSA-NBC ACTUATOR

MSA-NBC ACTUATOR



MSA-NBC OPTIONS

SHAFT TYPE

- Single
- Double

DRIVE SHAFT LOCATION

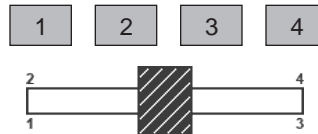

TRAVELS

(Min 150mm - Max 5600mm)

Sold & Serviced By:
ELECTROMATE
 Toll Free Phone (877) SERV098
 Toll Free Fax (877) SERV099
 www.electromate.com
 sales@electromate.com

OPTIONS FOR:

- Motor Mounting
- Sensors
- Gearbox

HOW TO BUILD YOUR MSA-NBC:

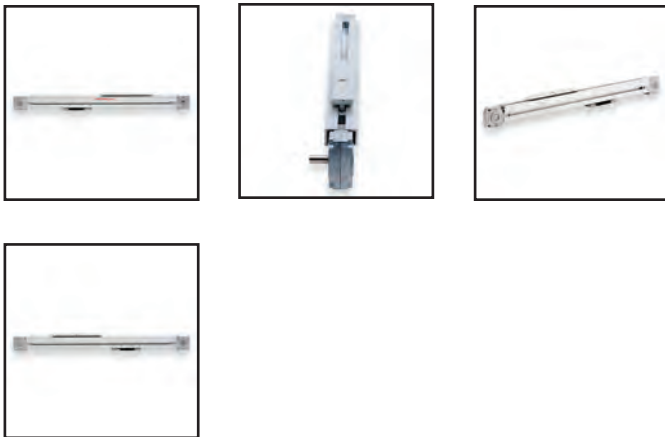

Macron Solutions Since 1987

MACRON DYNAMICS, INC.
 100 Phyllis Drive
 Croydon, PA 19021

1-800-MACRON-1 (1-800-622-7661)
 Phone: 267-557-3590
 Fax: 215-443-0981

© 2014 MACRON DYNAMICS, INC.

Macron Guarantee

All Macron actuators and belt drives are covered by our
 1-Year Warranty



BELT DRIVEN ACTUATORS > MSA-NBC ACTUATOR

MSA-NBC ACTUATOR

SPECIFICATIONS

Specifications

Motion	Horizontal or Vertical
Max Speed - horizontal [vertical] - mm / sec	2540 [1270]
Max Load - horizontal [vertical] - lbs.	100 [50]
Repeatability - mm	+/-0.025
Moment Load Max - in. - lbs. [Nm]	300 [34]
Positional Accuracy - mm / meter	+/- 0.4
Acceleration max - G's	5
Beam Dimensions - mm	56 x 56
Motor Sizing Information	
Weight of Drive Pulley - oz. / kgs.	4.7 / 0.13
Weight of Idler Pulley - oz. / kgs.	4.3 / 0.12
Weight of Cart - lbs. / kgs.	0.9 / 0.41
Weight of Belt - kgs. based on travel selected	((Travel in meters x 2) + 0.32) x 0.04
Travel per Revolution - mm	105
Pulley Pitch Diameter - mm	33.42
Pulley Material / Width - mm	steel / 12
Breakaway Torque - oz. - in.	30 - 32
Coefficient Friction	N/A
Rolling Resistance - lbs. / kgs.	0.002 / 0.001

SPECIFICATIONS

Weight

Weight - min. travel unit (150 mm) - lbs. / kgs.	4.0 / 1.8
Weight - additional 25 mm of travel - lbs. / kgs.	0.08 / 0.04
Travels	
Standard Travels - min max - mm (25 mm increment)	150 / 5600

Features

- Extruded aluminum actuator body with T-slots for easy mounting
- Easy to adjust belt tensioner
- One piece, machined and stress proof shafted pulley
- Zero backlash belt to pulley design
- Corrosion resistant components

Sold & Serviced By:

 Toll Free Phone (877) SERV098
 Toll Free Fax (877) SERV099
 www.electromate.com
 sales@electromate.com

Macron Solutions Since 1987

MACRON DYNAMICS, INC.
 100 Phyllis Drive
 Croydon, PA 19021
 © 2014 MACRON DYNAMICS, INC.

1-800-MACRON-1 (1-800-622-7661)
 Phone: 267-557-3590
 Fax: 215-443-0981

Macron Guarantee

All Macron actuators and belt drives are covered by our
 1-Year Warranty



BELT DRIVEN ACTUATORS > MSA-628 ACTUATOR

MSA-628 ACTUATOR



MSA-628 OPTIONS

SHAFT TYPE

- Single
- Double

DRIVE SHAFT LOCATION

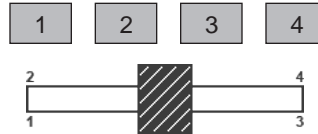

TRAVELS

(Min 150mm - Max 5775mm)

Sold & Serviced By:
ELECTROMATE
 Toll Free Phone (877) SERV098
 Toll Free Fax (877) SERV099
 www.electromate.com
 sales@electromate.com

OPTIONS FOR:

- Motor Mounting
- Sensors
- Gearbox

HOW TO BUILD YOUR MSA-628:

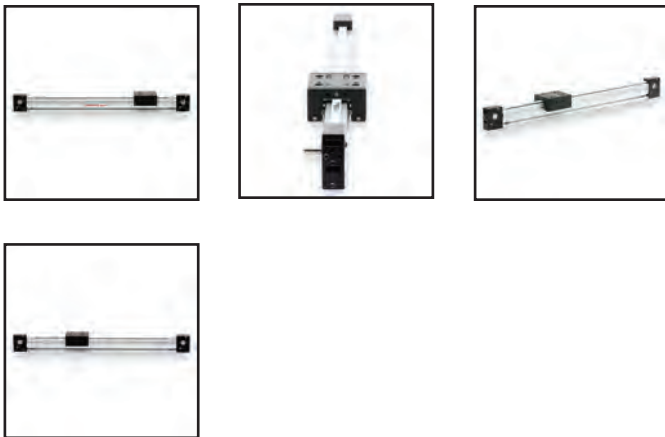

Macron Solutions Since 1987

MACRON DYNAMICS, INC. 1-800-MACRON-1 (1-800-622-7661)
 100 Phyllis Drive Phone: 267-557-3590
 Croydon, PA 19021 Fax: 215-443-0981
 © 2014 MACRON DYNAMICS, INC.

Macron Guarantee

All Macron actuators and belt drives are covered by our
 1-Year Warranty



BELT DRIVEN ACTUATORS > MSA-628 ACTUATOR

MSA-628 ACTUATOR

SPECIFICATIONS

Specifications

Motion	Horizontal or Vertical
Max Speed - horizontal [vertical] - mm / sec	6230 [3115]
Max Load - horizontal [vertical] - lbs.	50 [25]
Repeatability - mm	+/-0.025
Moment Load Max - in. - lbs. [Nm]	25 [2.8]
Positional Accuracy - mm / meter	+/- 0.4
Acceleration max - G's	5
Beam Dimensions - mm	28 x 56
Motor Sizing Information	
Weight of Drive Pulley - oz. / kgs.	4.7 / 0.13
Weight of Idler Pulley - oz. / kgs.	4.3 / 0.12
Weight of Cart - lbs. / kgs.	1.2 / 0.54
Weight of Belt - kgs. based on travel selected	((Travel in meters x 2) + 0.32) x 0.04
Travel per Revolution - mm	105
Pulley Pitch Diameter - mm	33.42
Pulley Material / Width - mm	steel / 12
Breakaway Torque - oz. - in.	8 - 10
Coefficient Friction	N/A
Rolling Resistance - lbs. / kgs.	0.002 / 0.001

SPECIFICATIONS

Weight

Weight - min. travel unit (150 mm) - lbs. / kgs.	6.6 / 3.0
Weight - additional 25 mm of travel - lbs. / kgs.	0.10 / 0.05
Travels	
Standard Travels - min max - mm (25 mm increment)	150 / 5775

Features

- Extruded aluminum actuator body with T-slots for ease of mounting
- Easy to adjust belt tensioner
- One piece, machined and stress proof shafted pulley
- Zero backlash belt to pulley design
- Corrosion resistant components

Sold & Serviced By:
ELECTROMATE
 Toll Free Phone (877) SERV098
 Toll Free Fax (877) SERV099
 www.electromate.com
 sales@electromate.com

Macron Solutions Since 1987

MACRON DYNAMICS, INC.
 100 Phyllis Drive
 Croydon, PA 19021
 © 2014 MACRON DYNAMICS, INC.

1-800-MACRON-1 (1-800-622-7661)
 Phone: 267-557-3590
 Fax: 215-443-0981

Macron Guarantee

All Macron actuators and belt drives are covered by our
 1-Year Warranty



BELT DRIVEN ACTUATORS > MSA-R15 ACTUATOR

MSA-R15 ACTUATOR



MSA-R15 OPTIONS

SHAFT TYPE

- Single
- Double

DRIVE SHAFT LOCATION

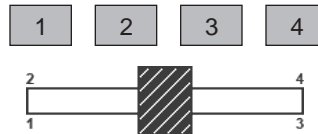

TRAVELS

(Min 150mm - Max 5775mm)

Sold & Serviced By:
ELECTROMATE
 Toll Free Phone (877) SERV098
 Toll Free Fax (877) SERV099
 www.electromate.com
 sales@electromate.com

OPTIONS FOR:

- Motor Mounting
- Sensors
- Gearbox

HOW TO BUILD YOUR MSA-R15:

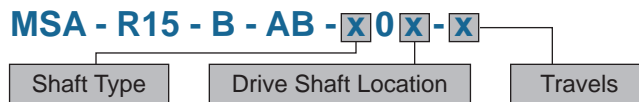

Macron Solutions Since 1987

MACRON DYNAMICS, INC. 1-800-MACRON-1 (1-800-622-7661)
 100 Phyllis Drive Phone: 267-557-3590
 Croydon, PA 19021 Fax: 215-443-0981
 © 2014 MACRON DYNAMICS, INC.

Macron Guarantee

All Macron actuators and belt drives are covered by our
 1-Year Warranty



BELT DRIVEN ACTUATORS > MSA-R15 ACTUATOR

MSA-R15 ACTUATOR

SPECIFICATIONS

Specifications

Motion	Horizontal or Vertical
Max Speed - horizontal [vertical] - mm / sec	5000 [5000]
Max Load - horizontal [vertical] - lbs.	150 [75]
Repeatability - mm	+/-0.025
Moment Load Max - in. - lbs. [Nm]	310 [35]
Positional Accuracy - mm / meter	+/- 0.4
Acceleration max - G's	20
Beam Dimensions - mm	N/A
Motor Sizing Information	
Weight of Drive Pulley - oz. / kgs.	4.7 / 0.13
Weight of Idler Pulley - oz. / kgs.	4.3 / 0.12
Weight of Cart - lbs. / kgs.	0.8 / 0.36
Weight of Belt - kgs. based on travel selected	((Travel in meters x 2) + 0.32) x 0.04
Travel per Revolution - mm	105
Pulley Pitch Diameter - mm	33.42
Pulley Material / Width - mm	steel / 12
Breakaway Torque - oz. - in.	13 - 14
Coefficient Friction	0.05
Rolling Resistance - lbs. / kgs.	N/A

SPECIFICATIONS

Weight

Weight - min. travel unit (150 mm) - lbs. / kgs.	4.6 / 2.1
Weight - additional 25 mm of travel - lbs. / kgs.	0.21 / 0.10

Travels

Standard Travels - min max - mm (25 mm increment)	150 / 5775
---	-------------------

Features

- Extruded aluminum actuator body with T-slots for ease of mounting
- Easy to adjust belt tensioner
- One piece, machined and stress proof shafted pulley
- Zero backlash belt to pulley design
- Corrosion resistant components

Sold & Serviced By:
ELECTROMATE
 Toll Free Phone (877) SERV098
 Toll Free Fax (877) SERV099
 www.electromate.com
 sales@electromate.com

Macron Solutions Since 1987

MACRON DYNAMICS, INC.
 100 Phyllis Drive
 Croydon, PA 19021
 © 2014 MACRON DYNAMICS, INC.

1-800-MACRON-1 (1-800-622-7661)
 Phone: 267-557-3590
 Fax: 215-443-0981

Macron Guarantee

All Macron actuators and belt drives are covered by our
 1-Year Warranty



BELT DRIVEN ACTUATORS > MSA-M6S ACTUATOR

MSA-M6S ACTUATOR



MSA-M6S OPTIONS

SHAFT TYPE

- Single
- Double

DRIVE SHAFT LOCATION

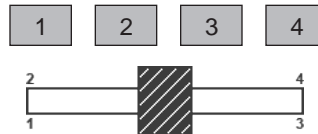

TRAVELS

(Min 150mm - Max 5750mm)

Sold & Serviced By:
ELECTROMATE
 Toll Free Phone (877) SERV098
 Toll Free Fax (877) SERV099
 www.electromate.com
 sales@electromate.com

OPTIONS FOR:

- Motor Mounting
- Sensors
- Gearbox



HOW TO BUILD YOUR MSA-M6S:



Macron Solutions Since 1987

MACRON DYNAMICS, INC. 1-800-MACRON-1 (1-800-622-7661)
 100 Phyllis Drive Phone: 267-557-3590
 Croydon, PA 19021 Fax: 215-443-0981
 © 2014 MACRON DYNAMICS, INC.

Macron Guarantee

All Macron actuators and belt drives are covered by our
 1-Year Warranty



BELT DRIVEN ACTUATORS > MSA-M6S ACTUATOR

MSA-M6S ACTUATOR

SPECIFICATIONS

Specifications

Motion	Horizontal or Vertical
Max Speed - horizontal [vertical] - mm / sec	6230 [3115]
Max Load - horizontal [vertical] - lbs.	50 [25]
Repeatability - mm	+/-0.025
Moment Load Max - in. - lbs. [Nm]	25 [2.8]
Positional Accuracy - mm / meter	+/- 0.4
Acceleration max - G's	9
Beam Dimensions - mm	40 x 80
Motor Sizing Information	
Weight of Drive Pulley - oz. / kgs.	11.3 / 0.32
Weight of Idler Pulley - oz. / kgs.	7.7 / 0.22
Weight of Cart - lbs. / kgs.	3.5 / 1.59
Weight of Belt - kgs. based on travel selected	((Travel in meters x 2) + 0.47) x 0.12
Travel per Revolution - mm	150
Pulley Pitch Diameter - mm	47.74
Pulley Material / Width - mm	steel / 25
Breakaway Torque - oz. - in.	30 - 32
Coefficient Friction	N/A
Rolling Resistance - lbs. / kgs.	0.008 / 0.004

SPECIFICATIONS

Weight

Weight - min. travel unit (150 mm) - lbs. / kgs.	12.8 / 5.8
Weight - additional 25 mm of travel - lbs. / kgs.	0.30 / 0.14
Travels	
Standard Travels - min max - mm (25 mm increment)	150 / 5750

Features

- Extruded aluminum actuator body with T-slots for ease of mounting
- Easy to adjust belt tensioner
- One piece, machined and stress proof shafted pulley
- Zero backlash belt to pulley design
- Corrosion resistant components

Sold & Serviced By:
ELECTROMATE
 Toll Free Phone (877) SERV098
 Toll Free Fax (877) SERV099
 www.electromate.com
 sales@electromate.com

Macron Solutions Since 1987

MACRON DYNAMICS, INC. 1-800-MACRON-1 (1-800-622-7661)
 100 Phyllis Drive Phone: 267-557-3590
 Croydon, PA 19021 Fax: 215-443-0981
 © 2014 MACRON DYNAMICS, INC.

Macron Guarantee

All Macron actuators and belt drives are covered by our
 1-Year Warranty



BELT DRIVEN ACTUATORS > MSA-R6S ACTUATOR

MSA-R6S ACTUATOR



MSA-R6S OPTIONS

SHAFT TYPE

- Single
- Double

DRIVE SHAFT LOCATION

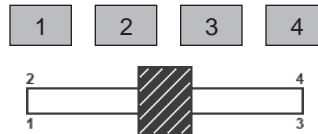

TRAVELS

(Min 150mm - Max 5750mm)

Sold & Serviced By:
ELECTROMATE
 Toll Free Phone (877) SERV098
 Toll Free Fax (877) SERV099
 www.electromate.com
 sales@electromate.com

OPTIONS FOR:

- Motor Mounting
- Sensors
- Gearbox

HOW TO BUILD YOUR MSA-R6S:



Macron Solutions Since 1987

MACRON DYNAMICS, INC.
 100 Phyllis Drive
 Croydon, PA 19021

1-800-MACRON-1 (1-800-622-7661)
 Phone: 267-557-3590
 Fax: 215-443-0981

© 2014 MACRON DYNAMICS, INC.

Macron Guarantee

All Macron actuators and belt drives are covered by our
 1-Year Warranty



BELT DRIVEN ACTUATORS > MSA-R6S ACTUATOR

MSA-R6S ACTUATOR

SPECIFICATIONS

Specifications

Motion	Horizontal or Vertical
Max Speed - horizontal [vertical] - mm / sec	5000 [5000]
Max Load - horizontal [vertical] - lbs.	300 [150]
Repeatability - mm	+/-0.025
Moment Load Max - in. - lbs. [Nm]	575 [65]
Positional Accuracy - mm / meter	+/- 0.4
Acceleration max - G's	20
Beam Dimensions - mm	N/A
Motor Sizing Information	
Weight of Drive Pulley - oz. / kgs.	11.3 / 0.32
Weight of Idler Pulley - oz. / kgs.	7.7 / 0.22
Weight of Cart - lbs. / kgs.	1.3 / 0.59
Weight of Belt - kgs. based on travel selected	$((\text{Travel in meters} \times 2) + 0.47) \times 0.12$
Travel per Revolution - mm	150
Pulley Pitch Diameter - mm	47.74
Pulley Material / Width - mm	steel / 25
Breakaway Torque - oz. - in.	13 - 14
Coefficient Friction	0.05
Rolling Resistance - lbs. / kgs.	N/A

SPECIFICATIONS

Weight

Weight - min. travel unit (150 mm) - lbs. / kgs.	8.4 / 3.8
Weight - additional 25 mm of travel - lbs. / kgs.	0.64 / 0.29
Travels	
Standard Travels - min max - mm (25 mm increment)	150 / 5750

Features

- Extruded aluminum actuator body with T-slots for ease of mounting
- Easy to adjust belt tensioner
- One piece, machined and stress proof shafted pulley
- Zero backlash belt to pulley design
- Corrosion resistant components

Sold & Serviced By:

 Toll Free Phone (877) SERV098
 Toll Free Fax (877) SERV099
 www.electromate.com
 sales@electromate.com

Macron Solutions Since 1987

MACRON DYNAMICS, INC.
 100 Phyllis Drive
 Croydon, PA 19021
 © 2014 MACRON DYNAMICS, INC.

1-800-MACRON-1 (1-800-622-7661)
 Phone: 267-557-3590
 Fax: 215-443-0981

Macron Guarantee

All Macron actuators and belt drives are covered by our
 1-Year Warranty



BELT DRIVEN ACTUATORS > MSA-135 ACTUATOR

MSA-135 ACTUATOR



MSA-135 OPTIONS

SHAFT TYPE

- Single
- Double

DRIVE SHAFT LOCATION

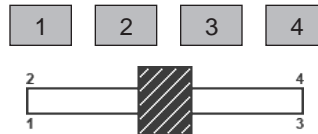

TRAVELS

(Min 150mm - Max 5550mm)

Sold & Serviced By:
ELECTROMATE
 Toll Free Phone (877) SERV098
 Toll Free Fax (877) SERV099
www.electromate.com
sales@electromate.com

OPTIONS FOR:

- Motor Mounting
- Sensors
- Gearbox



HOW TO BUILD YOUR MSA-135:



Macron Solutions Since 1987

MACRON DYNAMICS, INC. 1-800-MACRON-1 (1-800-622-7661)
 100 Phyllis Drive Phone: 267-557-3590
 Croydon, PA 19021 Fax: 215-443-0981
 © 2014 MACRON DYNAMICS, INC.

Macron Guarantee

All Macron actuators and belt drives are covered by our
 1-Year Warranty



BELT DRIVEN ACTUATORS > MSA-135 ACTUATOR

MSA-135 ACTUATOR

SPECIFICATIONS

Specifications

Motion	Horizontal or Vertical
Max Speed - horizontal [vertical] - mm / sec	5080 [5080]
Max Load - horizontal [vertical] - lbs.	500 [250]
Repeatability - mm	+/-0.025
Moment Load Max - in. - lbs. [Nm]	460 [52]
Positional Accuracy - mm / meter	+/- 0.4
Acceleration max - G's	10
Beam Dimensions - mm	40 x 80
Motor Sizing Information	
Weight of Drive Pulley - oz. / kgs.	11.3 / 0.32
Weight of Idler Pulley - oz. / kgs.	7.7 / 0.22
Weight of Cart - lbs. / kgs.	1.7 / 0.77
Weight of Belt - kgs. based on travel selected	((Travel in meters x 2) + 0.47) x 0.12
Travel per Revolution - mm	150
Pulley Pitch Diameter - mm	47.74
Pulley Material / Width - mm	steel / 25
Breakaway Torque - oz. - in.	32 - 36
Coefficient Friction	N/A
Rolling Resistance - lbs. / kgs.	0.006 / 0.003

SPECIFICATIONS

Weight

Weight - min. travel unit (150 mm) - lbs. / kgs.	10.8 / 4.9
Weight - additional 25 mm of travel - lbs. / kgs.	0.13 / 0.06
Travels	
Standard Travels - min max - mm (25 mm increment)	150 / 5550

Features

- Extruded aluminum actuator body with T-slots for ease of mounting
- Easy to adjust belt tensioner
- One piece, machined and stress proof shafted pulley
- Zero backlash belt to pulley design
- Corrosion resistant components

Sold & Serviced By:
ELECTROMATE
 Toll Free Phone (877) SERV098
 Toll Free Fax (877) SERV099
 www.electromate.com
 sales@electromate.com

Macron Solutions Since 1987

MACRON DYNAMICS, INC. 1-800-MACRON-1 (1-800-622-7661)
 100 Phyllis Drive Phone: 267-557-3590
 Croydon, PA 19021 Fax: 215-443-0981
 © 2014 MACRON DYNAMICS, INC.

Macron Guarantee

All Macron actuators and belt drives are covered by our
 1-Year Warranty



BELT DRIVEN ACTUATORS > MSA-R20 ACTUATOR

MSA-R20 ACTUATOR



MSA-R20 OPTIONS

SHAFT TYPE

- Single
- Double

DRIVE SHAFT LOCATION

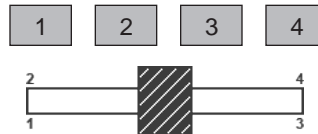

TRAVELS

(Min 150mm - Max 5575mm)

Sold & Serviced By:
ELECTROMATE
 Toll Free Phone (877) SERV098
 Toll Free Fax (877) SERV099
 www.electromate.com
 sales@electromate.com

OPTIONS FOR:

- Motor Mounting
- Sensors
- Gearbox

HOW TO BUILD YOUR MSA-R20:



Macron Solutions Since 1987

MACRON DYNAMICS, INC. 1-800-MACRON-1 (1-800-622-7661)
 100 Phyllis Drive Phone: 267-557-3590
 Croydon, PA 19021 Fax: 215-443-0981
 © 2014 MACRON DYNAMICS, INC.

Macron Guarantee

All Macron actuators and belt drives are covered by our
 1-Year Warranty



BELT DRIVEN ACTUATORS > MSA-R20 ACTUATOR

MSA-R20 ACTUATOR

SPECIFICATIONS

Specifications

Motion	Horizontal or Vertical
Max Speed - horizontal [vertical] - mm / sec	5000 [5000]
Max Load - horizontal [vertical] - lbs.	1000 [300]
Repeatability - mm	+/-0.025
Moment Load Max - in. - lbs. [Nm]	1062 [120]
Positional Accuracy - mm / meter	+/- 0.4
Acceleration max - G's	10
Beam Dimensions - mm	80 x 80
Motor Sizing Information	
Weight of Drive Pulley - oz. / kgs.	11.3 / 0.32
Weight of Idler Pulley - oz. / kgs.	7.7 / 0.22
Weight of Cart - lbs. / kgs.	4.0 / 1.81
Weight of Belt - kgs. based on travel selected	((Travel in meters x 2) + 0.47) x 0.12
Travel per Revolution - mm	150
Pulley Pitch Diameter - mm	47.74
Pulley Material / Width - mm	steel / 25
Breakaway Torque - oz. - in.	26 - 28
Coefficient Friction	0.05
Rolling Resistance - lbs. / kgs.	N/A

SPECIFICATIONS

Weight

Weight - min. travel unit (150 mm) - lbs. / kgs.	15.0 / 6.8
Weight - additional 25 mm of travel - lbs. / kgs.	0.75 / 0.034
Travels	
Standard Travels - min max - mm (25 mm increment)	150 / 5575

Features

- Extruded aluminum actuator body with T-slots for ease of mounting
- Easy to adjust belt tensioner
- One piece, machined and stress proof shafted pulley
- Zero backlash belt to pulley design
- Corrosion resistant components

Sold & Serviced By:
ELECTROMATE
 Toll Free Phone (877) SERV098
 Toll Free Fax (877) SERV099
 www.electromate.com
 sales@electromate.com

Macron Solutions Since 1987

MACRON DYNAMICS, INC.
 100 Phyllis Drive
 Croydon, PA 19021
 © 2014 MACRON DYNAMICS, INC.

1-800-MACRON-1 (1-800-622-7661)
 Phone: 267-557-3590
 Fax: 215-443-0981

Macron Guarantee

All Macron actuators and belt drives are covered by our
 1-Year Warranty



BELT DRIVEN ACTUATORS > MSA-SB1 BELT DRIVE

MSA-SB1 BELT DRIVE



MSA-SB1 OPTIONS

SHAFT TYPE

- Single
- Double

DRIVE SHAFT LOCATION

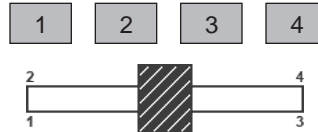

TRAVELS

(Min 150mm - Max 5750mm)

Sold & Serviced By:
ELECTROMATE
 Toll Free Phone (877) SERV098
 Toll Free Fax (877) SERV099
 www.electromate.com
 sales@electromate.com

OPTIONS FOR:

- Motor Mounting
- Sensors
- Gearbox

HOW TO BUILD YOUR MSA-SB1:



Macron Solutions Since 1987

MACRON DYNAMICS, INC.
 100 Phyllis Drive
 Croydon, PA 19021

1-800-MACRON-1 (1-800-622-7661)
 Phone: 267-557-3590
 Fax: 215-443-0981

© 2014 MACRON DYNAMICS, INC.

Macron Guarantee

All Macron actuators and belt drives are covered by our
 1-Year Warranty



BELT DRIVEN ACTUATORS > MSA-SB1 BELT DRIVE

MSA-SB1 BELT DRIVE

SPECIFICATIONS

Specifications

Motion	Horizontal or Vertical
Max Speed - horizontal [vertical] - mm / sec	5050 [2525]
Max Load - horizontal [vertical] - lbs.	100 [50]
Repeatability - mm	+/-0.025
Moment Load Max - in. - lbs. [Nm]	NONE
Positional Accuracy - mm / meter	+/- 0.4
Acceleration max - G's	5
Beam Dimensions - mm	28 x 56
Motor Sizing Information	
Weight of Drive Pulley - oz. / kgs.	4.7 / 0.13
Weight of Idler Pulley - oz. / kgs.	4.3 / 0.12
Weight of Cart - lbs. / kgs.	N/A
Weight of Belt - kgs. based on travel selected	((Travel in meters x 2) + 0.32) x 0.04
Travel per Revolution - mm	105
Pulley Pitch Diameter - mm	33.42
Pulley Material / Width - mm	steel / 12
Breakaway Torque - oz. - in.	N/A
Coefficient Friction	N/A
Rolling Resistance - lbs. / kgs.	N/A

SPECIFICATIONS

Weight

Weight - min. travel unit (150 mm) - lbs. / kgs.	5.5 / 2.5
Weight - additional 25 mm of travel - lbs. / kgs.	0.08 / 0.04
Travels	
Standard Travels - min max - mm (25 mm increment)	150 / 5750

Features

- Extruded aluminum actuator body with T-slots for easy mounting
- Easy to adjust belt tensioner
- One piece, machined and stress proof shafted pulley
- Zero backlash belt to pulley design
- Corrosion resistant components

Sold & Serviced By:
ELECTROMATE
 Toll Free Phone (877) SERV098
 Toll Free Fax (877) SERV099
 www.electromate.com
 sales@electromate.com

Macron Solutions Since 1987

MACRON DYNAMICS, INC. 1-800-MACRON-1 (1-800-622-7661)
 100 Phyllis Drive Phone: 267-557-3590
 Croydon, PA 19021 Fax: 215-443-0981
 © 2014 MACRON DYNAMICS, INC.

Macron Guarantee

All Macron actuators and belt drives are covered by our
 1-Year Warranty



BELT DRIVEN ACTUATORS > MSA-SB2 BELT DRIVE

MSA-SB2 BELT DRIVE



MSA-SB2 OPTIONS

SHAFT TYPE

- Single
- Double

DRIVE SHAFT LOCATION

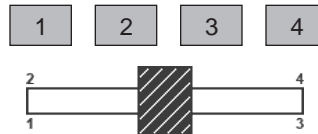

TRAVELS

(Min 150mm - Max 5775mm)

Sold & Serviced By:
ELECTROMATE
 Toll Free Phone (877) SERV098
 Toll Free Fax (877) SERV099
 www.electromate.com
 sales@electromate.com

OPTIONS FOR:

- Motor Mounting
- Sensors
- Gearbox

HOW TO BUILD YOUR MSA-SB2:



Macron Solutions Since 1987

MACRON DYNAMICS, INC.
 100 Phyllis Drive
 Croydon, PA 19021
 © 2014 MACRON DYNAMICS, INC.

1-800-MACRON-1 (1-800-622-7661)
 Phone: 267-557-3590
 Fax: 215-443-0981

Macron Guarantee

All Macron actuators and belt drives are covered by our
 1-Year Warranty



BELT DRIVEN ACTUATORS > MSA-SB2 BELT DRIVE

MSA-SB2 BELT DRIVE

SPECIFICATIONS

Specifications

Motion	Horizontal or Vertical
Max Speed - horizontal [vertical] - mm / sec	10160 [5080]
Max Load - horizontal [vertical] - lbs.	500 [250]
Repeatability - mm	+/-0.025
Moment Load Max - in. - lbs. [Nm]	NONE
Positional Accuracy - mm / meter	+/- 0.4
Acceleration max - G's	20
Beam Dimensions - mm	40 x 80
Motor Sizing Information	
Weight of Drive Pulley - oz. / kgs.	11.3 / 0.32
Weight of Idler Pulley - oz. / kgs.	7.7 / 0.22
Weight of Cart - lbs. / kgs.	N/A
Weight of Belt - kgs. based on travel selected	((Travel in meters x 2) + 0.47) x 0.12
Travel per Revolution - mm	150
Pulley Pitch Diameter - mm	47.74
Pulley Material / Width - mm	steel / 25
Breakaway Torque - oz. - in.	N/A
Coefficient Friction	N/A
Rolling Resistance - lbs. / kgs.	N/A

SPECIFICATIONS

Weight

Weight - min. travel unit (150 mm) - lbs. / kgs.	10.9 / 4.9
Weight - additional 25 mm of travel - lbs. / kgs.	0.15 / 0.07
Travels	
Standard Travels - min max - mm (25 mm increment)	150 / 5775

Features

- Extruded aluminum actuator body with T-slots for ease of mounting
- Easy to adjust belt tensioner
- One piece, machined and stress proof shafted pulley
- Zero backlash belt to pulley design
- Corrosion resistant components

Sold & Serviced By:
ELECTROMATE
 Toll Free Phone (877) SERV098
 Toll Free Fax (877) SERV099
 www.electromate.com
 sales@electromate.com

Macron Solutions Since 1987

MACRON DYNAMICS, INC. 1-800-MACRON-1 (1-800-622-7661)
 100 Phyllis Drive Phone: 267-557-3590
 Croydon, PA 19021 Fax: 215-443-0981
 © 2014 MACRON DYNAMICS, INC.

Macron Guarantee

All Macron actuators and belt drives are covered by our
 1-Year Warranty



BELT DRIVEN ACTUATORS > MSA-SB5 BELT DRIVE

MSA-SB5 BELT DRIVE



MSA-SB5 OPTIONS

SHAFT TYPE

- Single
- Double

DRIVE SHAFT LOCATION

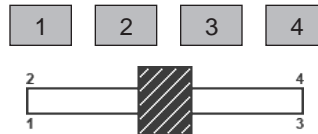

TRAVELS

(Min 150mm - Max 5575mm)

Sold & Serviced By:
ELECTROMATE
 Toll Free Phone (877) SERV098
 Toll Free Fax (877) SERV099
 www.electromate.com
 sales@electromate.com

OPTIONS FOR:

- Motor Mounting
- Sensors
- Gearbox

HOW TO BUILD YOUR MSA-SB5:



Macron Solutions Since 1987

MACRON DYNAMICS, INC.
 100 Phyllis Drive
 Croydon, PA 19021

1-800-MACRON-1 (1-800-622-7661)
 Phone: 267-557-3590
 Fax: 215-443-0981

© 2014 MACRON DYNAMICS, INC.

Macron Guarantee

All Macron actuators and belt drives are covered by our
 1-Year Warranty



BELT DRIVEN ACTUATORS > MSA-SB5 BELT DRIVE

MSA-SB5 BELT DRIVE

SPECIFICATIONS

Specifications

Motion	Horizontal or Vertical
Max Speed - horizontal [vertical] - mm / sec	10160 [5080]
Max Load - horizontal [vertical] - lbs.	1000 [500]
Repeatability - mm	+/-0.025
Moment Load Max - in. - lbs. [Nm]	NONE
Positional Accuracy - mm / meter	+/- 0.4
Acceleration max - G's	20
Beam Dimensions - mm	80 x 98
Motor Sizing Information	
Weight of Drive Pulley - oz. / kgs.	28.4 / 0.81
Weight of Idler Pulley - oz. / kgs.	26.4 / 0.75
Weight of Cart - lbs. / kgs.	N/A
Weight of Belt - kgs. based on travel selected	((Travel in meters x 2) + 0.47) x 0.35
Travel per Revolution - mm	150
Pulley Pitch Diameter - mm	47.74
Pulley Material / Width - mm	steel / 50
Breakaway Torque - oz. - in.	N/A
Coefficient Friction	N/A
Rolling Resistance - lbs. / kgs.	N/A

SPECIFICATIONS

Weight

Weight - min. travel unit (150 mm) - lbs. / kgs.	18.7 / 8.5
Weight - additional 25 mm of travel - lbs. / kgs.	0.28 / 0.13
Travels	
Standard Travels - min max - mm (25 mm increment)	150 / 5700

Features

- Extruded aluminum actuator body with T-slots for easy mounting
- Easy to adjust belt tensioner
- One piece, machined and stress proof shafted pulley
- Zero backlash belt to pulley design
- Corrosion resistant components

Sold & Serviced By:
ELECTROMATE
 Toll Free Phone (877) SERV098
 Toll Free Fax (877) SERV099
 www.electromate.com
 sales@electromate.com

Macron Solutions Since 1987

MACRON DYNAMICS, INC. 1-800-MACRON-1 (1-800-622-7661)
 100 Phyllis Drive Phone: 267-557-3590
 Croydon, PA 19021 Fax: 215-443-0981
 © 2014 MACRON DYNAMICS, INC.

Macron Guarantee

All Macron actuators and belt drives are covered by our
 1-Year Warranty



BELT DRIVEN ACTUATORS > MSA-SBH BELT DRIVE

MSA-SBH BELT DRIVE



MSA-SBH OPTIONS

SHAFT TYPE

- Single
- Double

DRIVE SHAFT LOCATION

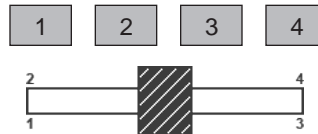

TRAVELS

(Min 150mm - Max 5625mm)

Sold & Serviced By:
ELECTROMATE
 Toll Free Phone (877) SERV098
 Toll Free Fax (877) SERV099
 www.electromate.com
 sales@electromate.com

OPTIONS FOR:

- Motor Mounting
- Sensors
- Gearbox

HOW TO BUILD YOUR MSA-SBH:



Macron Solutions Since 1987

MACRON DYNAMICS, INC.
 100 Phyllis Drive
 Croydon, PA 19021

1-800-MACRON-1 (1-800-622-7661)
 Phone: 267-557-3590
 Fax: 215-443-0981

© 2014 MACRON DYNAMICS, INC.

Macron Guarantee

All Macron actuators and belt drives are covered by our
 1-Year Warranty



BELT DRIVEN ACTUATORS > MSA-SBH BELT DRIVE

MSA-SBH BELT DRIVE

SPECIFICATIONS

Specifications

Motion	Horizontal or Vertical
Max Speed - horizontal [vertical] - mm / sec	15240 [7620]
Max Load - horizontal [vertical] - lbs.	2500 [1250]
Repeatability - mm	+/-0.025
Moment Load Max - in. - lbs. [Nm]	NONE
Positional Accuracy - mm / meter	+/- 0.4
Acceleration max - G's	20
Beam Dimensions - mm	80 x 98
Motor Sizing Information	
Weight of Drive Pulley - oz. / kgs.	105 / 2.98
Weight of Idler Pulley - oz. / kgs.	92 / 2.60
Weight of Cart - lbs. / kgs.	N/A
Weight of Belt - kgs. based on travel selected	((Travel in meters x 2) + 0.84) x 0.35
Travel per Revolution - mm	280
Pulley Pitch Diameter - mm	89.13
Pulley Material / Width - mm	steel / 50
Breakaway Torque - oz. - in.	N/A
Coefficient Friction	N/A
Rolling Resistance - lbs. / kgs.	N/A

SPECIFICATIONS

Weight

Weight - min. travel unit (150 mm) - lbs. / kgs.	41.7 / 18.9
Weight - additional 25 mm of travel - lbs. / kgs.	0.28 / 0.13
Travels	
Standard Travels - min max - mm (25 mm increment)	150 / 5625

Features

- Extruded aluminum actuator body with T-slots for easy mounting
- Easy to adjust belt tensioner
- One piece, machined and stress proof shafted pulley
- Zero backlash belt to pulley design
- Corrosion resistant components

Sold & Serviced By:
ELECTROMATE
 Toll Free Phone (877) SERV098
 Toll Free Fax (877) SERV099
 www.electromate.com
 sales@electromate.com

Macron Solutions Since 1987

MACRON DYNAMICS, INC.
 100 Phyllis Drive
 Croydon, PA 19021
 © 2014 MACRON DYNAMICS, INC.

1-800-MACRON-1 (1-800-622-7661)
 Phone: 267-557-3590
 Fax: 215-443-0981

Macron Guarantee

All Macron actuators and belt drives are covered by our
 1-Year Warranty



SCREW DRIVEN ACTUATORS > MSA-PSS ACTUATOR

MSA-PSS ACTUATOR



MSA-PSS OPTIONS

SCREW PITCH (INCHES)

- 1/4 - 4
- Custom

STANDARD TRAVELS (MM)

- 102
- 153
- 204
- 254
- 305
- Custom

OPTIONS FOR:

- Controls
- Motor
- Gearbox

Sold & Serviced By:
ELECTROMATE
 Toll-Free Phone (877) SERV098
 Toll-Free Fax (877) SERV099
 www.electromate.com
 sales@electromate.com

HOW TO BUILD YOUR MSA-DRT:



Macron Solutions Since 1987

MACRON DYNAMICS, INC. 1-800-MACRON-1 (1-800-622-7661)
 100 Phyllis Drive Phone: 267-557-3590
 Croydon, PA 19021 Fax: 215-443-0981
 © 2014 MACRON DYNAMICS, INC.

Macron Guarantee

All Macron actuators and belt drives are covered by our
 1-Year Warranty



SCREW DRIVEN ACTUATORS > MSA-PSS ACTUATOR

MSA-PSS ACTUATOR

SPECIFICATIONS

Specifications

Screw Ptich	1/4 - 4 in.
Nut Type	Lead Nut
Maximum Speed	180 in./min. (in.)
Maximum Load	25 lbs.
Repeatability	+/- 0.01 in.
Moment Load	10# at 152 mm
Linear Accuracy	+/- 0.008/24.5 mm
Backlash (inches max.)	0.007 in
Efficiency	75%

Motor Sizing Information

Weight of Cart	0.25 lbs.
Travel per Revolution	0.25 in./min. (in.)
Torque to Raise 1lb.	0.056 in./min. (in.)

Weight

Weight - lbs. w/motor adaptor	1.3 lbs. (377 mm), 1.4 lbs. (428 mm), 1.5 lbs. (479 mm), 1.8 lbs. (529 mm), 2.0 lbs. (580 mm)
-------------------------------	---

Travels

Standard Travels	102 to 305 mm
------------------	---------------

Features

- Economical lead screw with plastic nut drive
- Threaded over-molded inserts to mount devices to cart
- Open design for easy cleaning and harsh environment use
- Fitted with a 2nd cart top the unit can be converted from a screw table to a screw actuated push rod
- Adjustable mounting plates provide flexible attachment
- Submersible

Sold & Serviced By:

 Toll Free Phone (877) SERV098
 Toll Free Fax (877) SERV099
 www.electromate.com
 sales@electromate.com

Macron Solutions Since 1987

MACRON DYNAMICS, INC. 1-800-MACRON-1 (1-800-622-7661)
 100 Phyllis Drive Phone: 267-557-3590
 Croydon, PA 19021 Fax: 215-443-0981
 © 2014 MACRON DYNAMICS, INC.

Macron Guarantee

All Macron actuators and belt drives are covered by our
 1-Year Warranty



SCREW DRIVEN ACTUATORS > MSA-DRT ACTUATOR

MSA-DRT ACTUATOR



MSA-DRT OPTIONS

SCREW PITCH (INCHES)

- 0.2
- 0.5
- 1.0
- Custom

STANDARD TRAVELS (MM)

- 160
- 320
- 480
- 640
- Custom

OPTIONS FOR:

- Controls
- Motor
- Gearbox

Sold & Serviced By:
ELECTROMATE
 Toll Free Phone (877) SERV098
 Toll Free Fax (877) SERV099
 www.electromate.com
 sales@electromate.com

HOW TO BUILD YOUR MSA-DRT:



Macron Solutions Since 1987

MACRON DYNAMICS, INC. 1-800-MACRON-1 (1-800-622-7661)
 100 Phyllis Drive Phone: 267-557-3590
 Croydon, PA 19021 Fax: 215-443-0981
 © 2014 MACRON DYNAMICS, INC.

Macron Guarantee

All Macron actuators and belt drives are covered by our
 1-Year Warranty



SCREW DRIVEN ACTUATORS > MSA-DRT ACTUATOR

MSA-DRT ACTUATOR

SPECIFICATIONS

Specifications	
Screw Pitch	0.2 in.
Nut Type	Ball Screw
Maximum Speed	300 in./min. (0.2 in.), 600 in./min. (0.5 in.), 600 in./min. (1.0 in.)
Maximum Load	75 lbs.
Repeatability	+/- 0.005 in.
Moment Load	25# at 12 mm
Efficiency	90%
Motor Sizing Information	
Weight of Cart	2.5 lbs.
Travel per Revolution	0.25 in./min. (0.2 in.), 0.5 in./min.(0.5 in.), 1.0 in./min.(1.0 in.)
Torque to Raise 1lb.	0.035 in./min. (0.2 in.), 0.088 in./min. (0.5 in.), 0.177 in./min. (1.0 in.)

SPECIFICATIONS

Weight	
Weight - lbs. w/motor adaptor	17.2 lbs. (384 mm), 22.5 lbs. (544 mm), 28.2 lbs. (704 mm), 33.0 lbs. (864 mm)
Travels	
Standard Travels	160 to 640 mm

Features

- Commercial grade actuator with ball screw drive
- Extruded base profile and cart top allows multi-side mounting and attachment of components using T-nut fasteners
- Sealed linear profile rail and bearing guidance
- Can easily combine with MacSTANDARD belt actuators to create hybrid multi-axis systems
- Optional bellows seals are available
- Motor adaptors or MPG gearboxes are available accessories

Sold & Serviced By:

 Toll Free Phone (877) SERV098
 Toll Free Fax (877) SERV099
 sales@electromate.com

Macron Solutions Since 1987

MACRON DYNAMICS, INC. 1-800-MACRON-1 (1-800-622-7661)
 100 Phyllis Drive Phone: 267-557-3590
 Croydon, PA 19021 Fax: 215-443-0981
 © 2014 MACRON DYNAMICS, INC.

Macron Guarantee

All Macron actuators and belt drives are covered by our
 1-Year Warranty



SCREW DRIVEN ACTUATORS > MSA-SRT ACTUATOR

MSA-SRT ACTUATOR



MSA-SRT OPTIONS

SCREW PITCH (INCHES)

- 0.2
- 0.5
- 1.0
- Custom

STANDARD TRAVELS (MM)

- 160
- 320
- 480
- 640
- Custom

OPTIONS FOR:

- Controls
- Motor
- Gearbox

Sold & Serviced By:
ELECTROMATE
 Toll-Free Phone (877) SERV098
 Toll-Free Fax (877) SERV099
 www.electromate.com
 sales@electromate.com

HOW TO BUILD YOUR MSA-DRT:



Features

- Commercial grade actuator with ball screw drive
- Extruded base profile allows multiple side mounting and attachment of elements using T-nut fasteners
- Sealed linear profile rail and bearing guidance
- Motor adaptors or MPG gearboxes are available accessories

Macron Solutions Since 1987

MACRON DYNAMICS, INC. 1-800-MACRON-1 (1-800-622-7661)
 100 Phyllis Drive Phone: 267-557-3590
 Croydon, PA 19021 Fax: 215-443-0981
 © 2014 MACRON DYNAMICS, INC.

Macron Guarantee

All Macron actuators and belt drives are covered by our
 1-Year Warranty



SCREW DRIVEN ACTUATORS > MSA-SRT ACTUATOR

MSA-SRT ACTUATOR

SPECIFICATIONS

Specifications	
Screw Pitch	0.2 in.
Nut Type	Ball Screw
Maximum Speed	300 in./min. (0.2 in.), 600 in./min. (0.5 in.), 600 in./min. (1.0 in.)
Maximum Load	50 lbs.
Repeatability	+/- 0.005 in.
Moment Load	25# at 6 mm
Efficiency	90%
Motor Sizing Information	
Weight of Cart	1.2 lbs.
Travel per Revolution	0.25 in./min. (0.2 in.), 0.5 in./min. (0.5 in.), 1.0 in./min. (1.0 in.)
Torque to Raise 1lb.	0.035 in./min. (0.2 in.), 0.088 in./min. (0.5 in.), 0.177 in./min. (1.0 in.)

SPECIFICATIONS

Weight	
Weight - lbs. w/motor adaptor	9.0 lbs. (319 mm), 11.0 lbs. (479 mm), 14.0 lbs. (639 mm), 17.0 lbs. (799 mm)
Travels	
Standard Travels	160 to 640 mm

Sold & Serviced By:

 Toll Free Phone (877) SERV098
 Toll Free Fax (877) SERV099
 www.electromate.com
 sales@electromate.com

Macron Solutions Since 1987

MACRON DYNAMICS, INC. 1-800-MACRON-1 (1-800-622-7661)
 100 Phyllis Drive Phone: 267-557-3590
 Croydon, PA 19021 Fax: 215-443-0981
 © 2014 MACRON DYNAMICS, INC.

Macron Guarantee

All Macron actuators and belt drives are covered by our
 1-Year Warranty



SCREW DRIVEN ACTUATORS > MSA-DRT WITH BELLOWS

MSA-DRT with Bellows

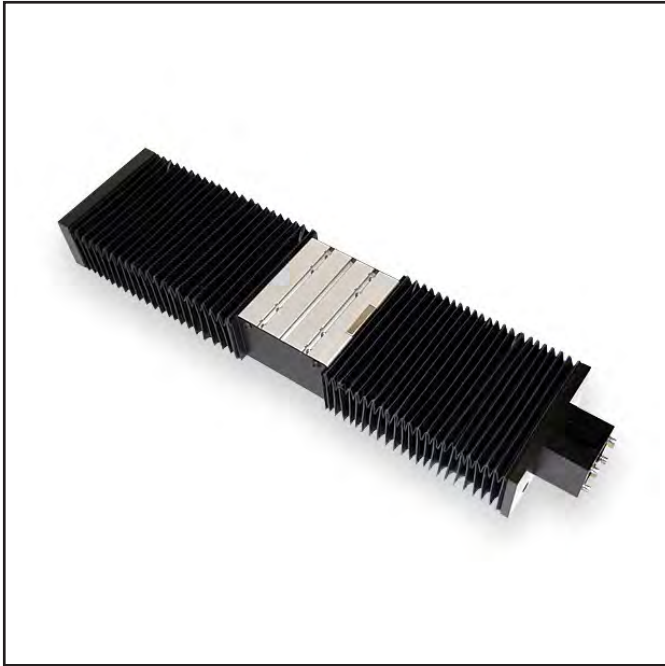

MSA-DRT OPTIONS

SCREW PITCH (INCHES)

- 0.2
- 0.5
- 1.0
- Custom

STANDARD TRAVELS (MM)

- 160
- 320
- 480
- 640
- Custom

OPTIONS FOR:

- Controls
- Motor
- Gearbox

Sold & Serviced By:
ELECTROMATE
 Toll-Free Phone (877) SERV098
 Toll-Free Fax (877) SERV099
 www.electromate.com
 sales@electromate.com

HOW TO BUILD YOUR MSA-DRT:



Features

- Baffles protect screw and internal components from debris and other elements that may be present in the application environment
- Commercial grade actuator with ball screw drive
- Extruded base profile and cart top allows multi-side mounting and attachment of components using T-nut fasteners
- Sealed linear profile rail and bearing guidance
- Can easily combine with MacSTANDARD belt actuators to create hybrid multi-axis systems
- Optional bellows seals are available
- Motor adaptors or MPG gearboxes are available accessories

Macron Solutions Since 1987

MACRON DYNAMICS, INC. 1-800-MACRON-1 (1-800-622-7661)
 100 Phyllis Drive Phone: 267-557-3590
 Croydon, PA 19021 Fax: 215-443-0981
 © 2014 MACRON DYNAMICS, INC.

Macron Guarantee

All Macron actuators and belt drives are covered by our
 1-Year Warranty



SCREW DRIVEN ACTUATORS > MSA-DRT WITH BELLOWS

MSA-DRT with Bellows

SPECIFICATIONS

Specifications	
Screw Pitch	0.2 in.
Nut Type	Ball Screw
Maximum Speed	300 in./min. (0.2 in.), 600 in./min. (0.5 in.), 600 in./min. (1.0 in.)
Maximum Load	75 lbs.
Repeatability	+/- 0.005 in.
Moment Load	25# at 12 mm
Efficiency	90%
Motor Sizing Information	
Weight of Cart	2.5 lbs.
Travel per Revolution	0.25 in./min. (0.2 in.), 0.5 in./min. (0.5 in.), 1.0 in./min. (1.0 in.)
Torque to Raise 1lb.	0.035 in./min. (0.2 in.), 0.088 in./min. (0.5 in.), 0.177 in./min. (1.0 in.)

SPECIFICATIONS

Weight	
Weight - lbs. w/motor adaptor	17.2 lbs. (384 mm), 22.5 lbs. (544 mm), 28.2 lbs. (704 mm), 33.0 lbs. (864 mm)
Travels	
Standard Travels	160 to 640 mm

Sold & Serviced By:

 Toll Free Phone (877) SERV098
 Toll Free Fax (877) SERV099
 www.electromate.com
 sales@electromate.com

Macron Solutions Since 1987

MACRON DYNAMICS, INC. 1-800-MACRON-1 (1-800-622-7661)
 100 Phyllis Drive Phone: 267-557-3590
 Croydon, PA 19021 Fax: 215-443-0981
 © 2014 MACRON DYNAMICS, INC.

Macron Guarantee

All Macron actuators and belt drives are covered by our
 1-Year Warranty