

QuickStep

– the integrated stepper motor

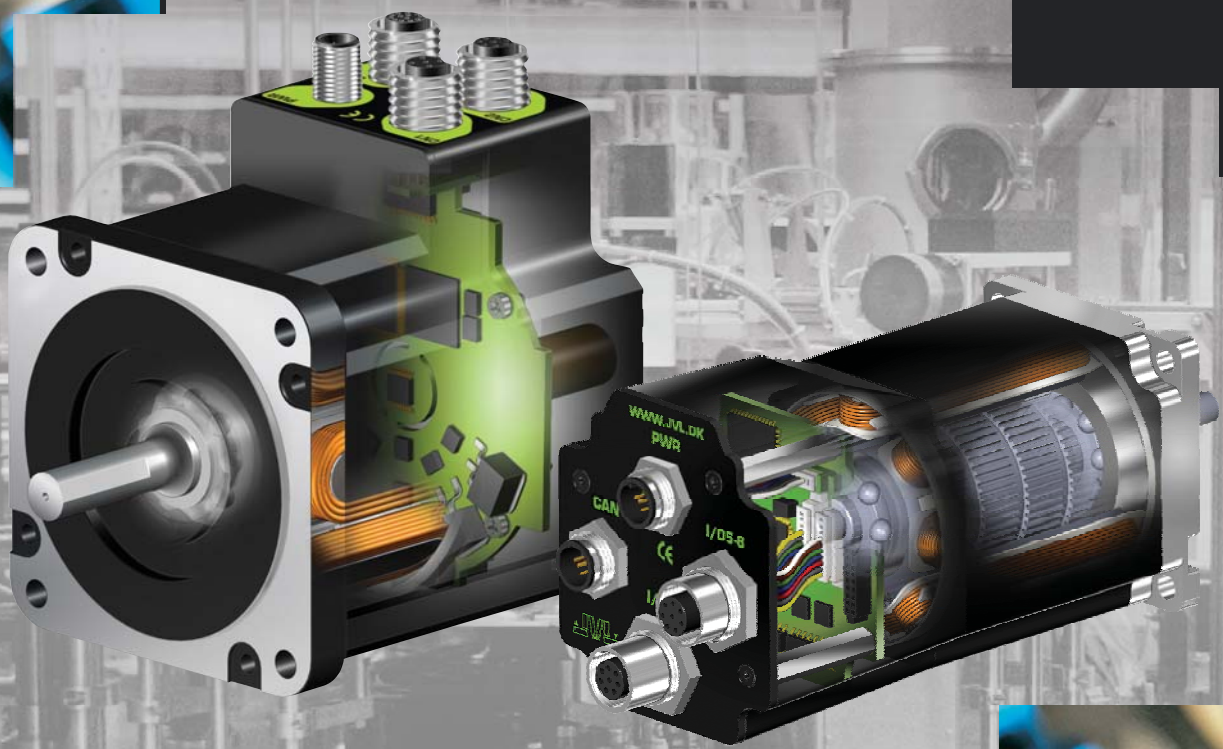

A new way of saving money
All Electronics Inside

Stepper motors
with integrated controller

Sold & Service By:
 **ELECTROMATE**
Toll Free Phone (877) SERV098
Toll Free Fax (877) SERV099
www.electromate.com
sales@electromate.com





Save Money and Troubles

Formerly building up a motion control system was a complicated affair involving many components:

- PLC
- Indexer/controller
- Indexer/controller
- Driver
- Stepper Motor (or a servo motor w/Encoder and Hall Sensor)
- A lot of cabling to connect all these items
- And finally a complex software that had to be programmed properly

It required a lot of expertise to make the system function correctly, and installation was very time consuming and many sources of potential faults.

Electrical noise from the cables carrying the high motor currents added to the problems.

JVL has reduced these problems to a minimum with the introduction of the integrated QuickStep motor to the motion control market.

In these motors the Indexer/controller, Driver, and optional wireless, ethernet, and an encoder are all built together with the motor in one compact unit.

One software package, MacTalk, makes set-up extremely easy, and the different motor types adapt the motor to almost any application.

By investing in a modern integrated QuickStep motor from JVL you achieve the following benefits:

- Reduced material costs because the driver and controller are integrated into the motor. Most cabling to the control panel is eliminated
- Reduced labour costs since cabling is minimised. Assembly time is greatly reduced
- Better quality and reliability
- Fewer connections, less wiring
- Ease of serviceability
- Double supply facility to ensure that position and parameters are maintained after emergency stop
- Switching noise from the drive due to commutation is contained in the motor
- OEM cost savings
- Same physical size even with various options such as Ethernet and wireless

Previous system build-up

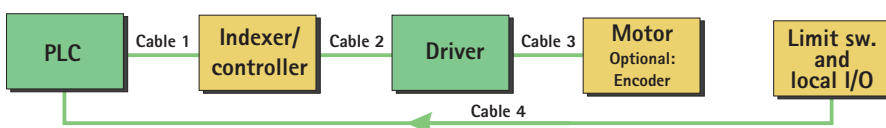

Modern system build-up

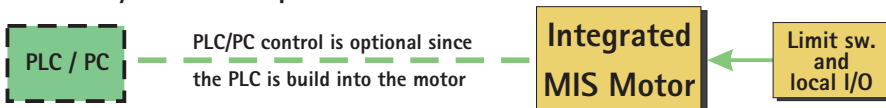

TT2314-01GB

Sold & Serviced By:
 **ELECTROMATE**

Toll Free Phone (877) SERV098
 Toll Free Fax (877) SERV099
www.electromate.com
sales@electromate.com



The MIS23x family for and low torque applications

Torque: 1.2 to 3.3 Nm

The major advantages of the QuickStep motors:

- High performance
- Cost effective
- Simple installation. No cables between motor and driver
- Decentralized intelligence
- Maintenance free operation
- EMC safe. Switching noise remains within motor
- Stall-detection by means of optional built-in encoder (i.e. same dimensions)
- Compact. Does not take up space in control cabinet
- 12-48VDC (12-80VDC) Power Supply
- Low-cost alternative to separate step (or servo) motor and driver
- High efficiency, i.e. "green motor and driver"
- Low installation cost. Shorter and faster installation
- High-quality, high-torque stepper motors
- Less risks of wiring errors
- MAC motor protocol so MAC motors and QuickStep motors can be connected on the same RS485 bus
- New users can easily set up the system
- NEMA 23 sizes can be delivered with pulse/direction driver PCB (type SMD73 / SMD74)
- Pulse and direction input makes it possible to use in any stepper motor application
- Encoder, pulse or SSI absolute interface
- CANopen and Profibus fieldbusses
- Wireless: Bluetooth, ZigBee and WLAN (only MIS34x)
- Ethernet interface (only MIS34x)
- The I/O points in all controller models can be setup by users as Input or Output – or as Analog input
- Easy and simple Windows program available for installation and setup
- Resolution 1,600 pulses/rev in MIS23x – and 409,600 pulses/rev in MIS34x
- Torque range 0.0 - 9.0 Nm

Optional semi absolute multiturn magnetic encoder for precise positioning and stall detection

Robust M12 connectors type IP67 for use in harsh environment

Wide supply range
Pulse/direction driver and Controller versions : 12 to 48VDC

RS485 and CANopen interface for setup and monitoring

5-28V I/O that can be configured as inputs, outputs or analogue inputs

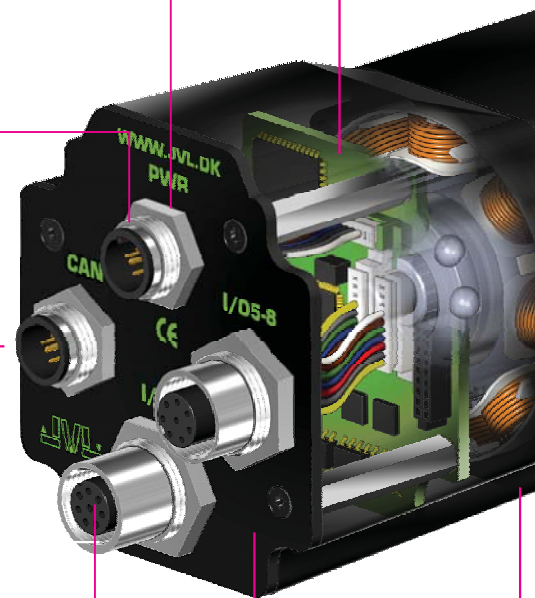

High-efficiency Power Mos-Fets in motor driver

The "Quickstep family"



Cables

Cables for all types of set up can be delivered as required. In this way installation is fast and easy for our customers. Please see our complete cable list at www.jvl.dk



Electronic brake

Optionally an electronic brake, type MAB23x for all motors with NEMA 23 and MAB34x for all motors with NEMA 34 flange.

Sold & Serviced By: **ELECTROMATE**
 the motor is used in vertical application
 Toll Free Phone: (877) 587-0098
 Toll Free Fax: (877) 587-0099
www.electromate.com
sales@electromate.com

medium applications

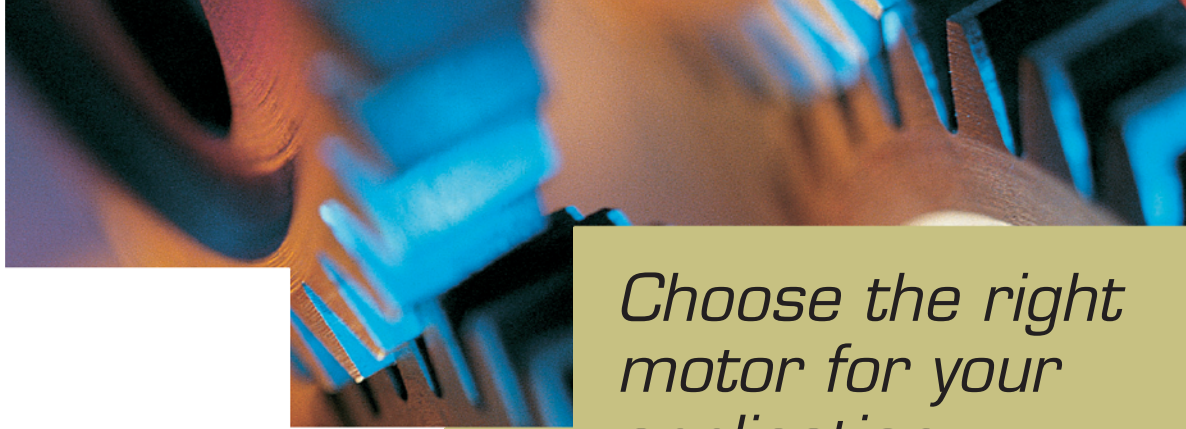

Choose the right motor for your application

You can choose between several different QuickStep motor types – including wireless communications models. All motors come standard with M12 connectors which ensures reliable connections. Some motors we can deliver with cable glands. Please contact your local distributor to learn more.

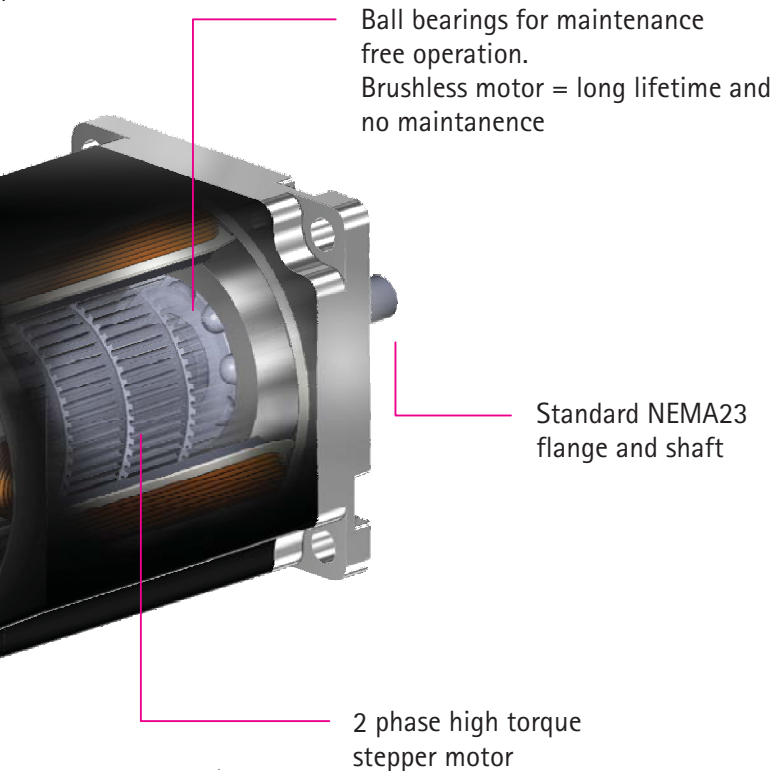

Ball bearings for maintenance free operation.
Brushless motor = long lifetime and no maintenance

Standard NEMA23 flange and shaft

2 phase high torque stepper motor

Robust aluminium housing which protects and shields the internal components

MIS23x Connectivity

Available connectivity options



RS 485
1Mbit

CANopen
RS 485
1Mbit

Analog



Nano
PLC

And more to come soon



Power Supplies

JVL can supply a wide range of power supplies for supplying one or several QuickStep motors. They range from very simple do-it-yourself kits to big switch mode supplies

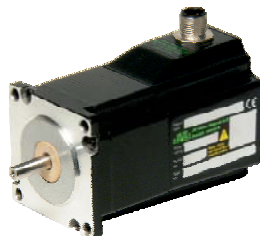

IP 67 Protection

IP67 versions can also be delivered. They are resistant against rough chemicals and ideal for use in food processing, pharmaceutical, medical and chemical industries. Come with a maintenance free teflon shaft sealing, leak-proof cable entry and stainless steel flange and shaft

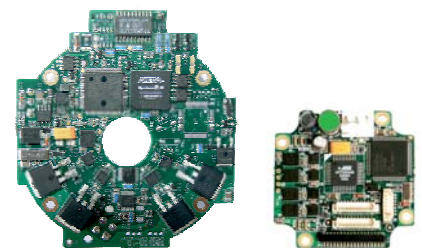

Stand-alone controller

The internal controller board from the MIS23x and MIS34x motors are also available as independent parts. The SMC75 controller runs at 12-48V and can source up to 5A RMS per motor phase. The SMC85 controller runs at 12-80V and can source up to 8A RMS per motor phase.

Sold & Serviced By:
ELECTROMATE
Toll Free Phone (877) SERV098
www.electromate.com
sales@electromate.com



All types with controller have RS485 serial interface and Nano-PLC control, while the driver types have Pulse and Direction signals only. Optional motor versions exist with alternative interfaces such as CANopen, Industrial Ethernet, SSI, or Wireless. Moreover, if you do not find the feature you need please contact us and we may be able to develop a customized type for you.

The MIS 34x family world's most compact Ultra high resolution

Torque: 3.0 to 9.0 Nm

12-28 VDC control voltage
12-80 VDC main supply (motor)

Robust aluminium housing which protects and shields the internal components

MIS34x Connectivity

Available connectivity options

Under development
- please contact your JVL distributor

And more to come soon

Standard NEMA34 flange and shaft

Ball bearings for maintenance free operation.
Brushless motor = long lifetime and no maintenance

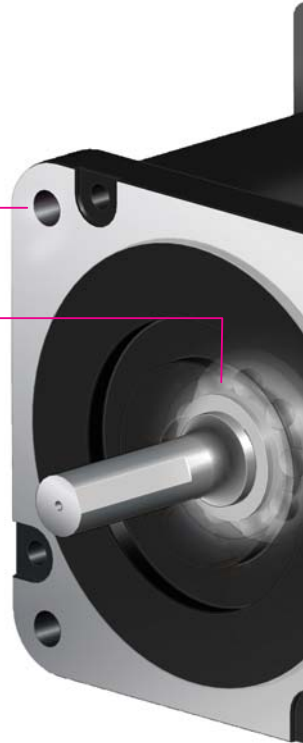

2-phase high torque stepper motor

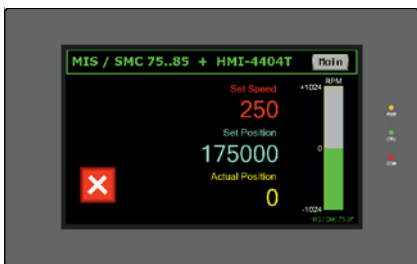

Operator panels - HMIs

JVL delivers color touch HMIs with "MAC motor protocol" that connects directly with QuickStep and MAC motor integrated motors (step and servo). Wide range of HMI's from 4.3" ..15" with or without Soft PLC (CoDeSys).

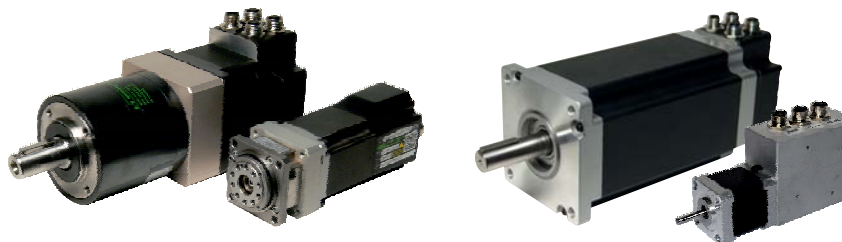

Gears

A wide range of planetary, worm and backlash free gear boxes are provided by JVL for the QuickStep motors

NEMA 43 and 17 Models

Soon available
They will further extend the range of QuickStep integrated stepper motors

Sold & Serviced By:
ELECTROMATE
Toll Free Phone (877) SERV098
Toll Free Fax (877) 987-099
www.electromate.com
sales@electromate.com

act!
 n of 409,600 steps/rev.

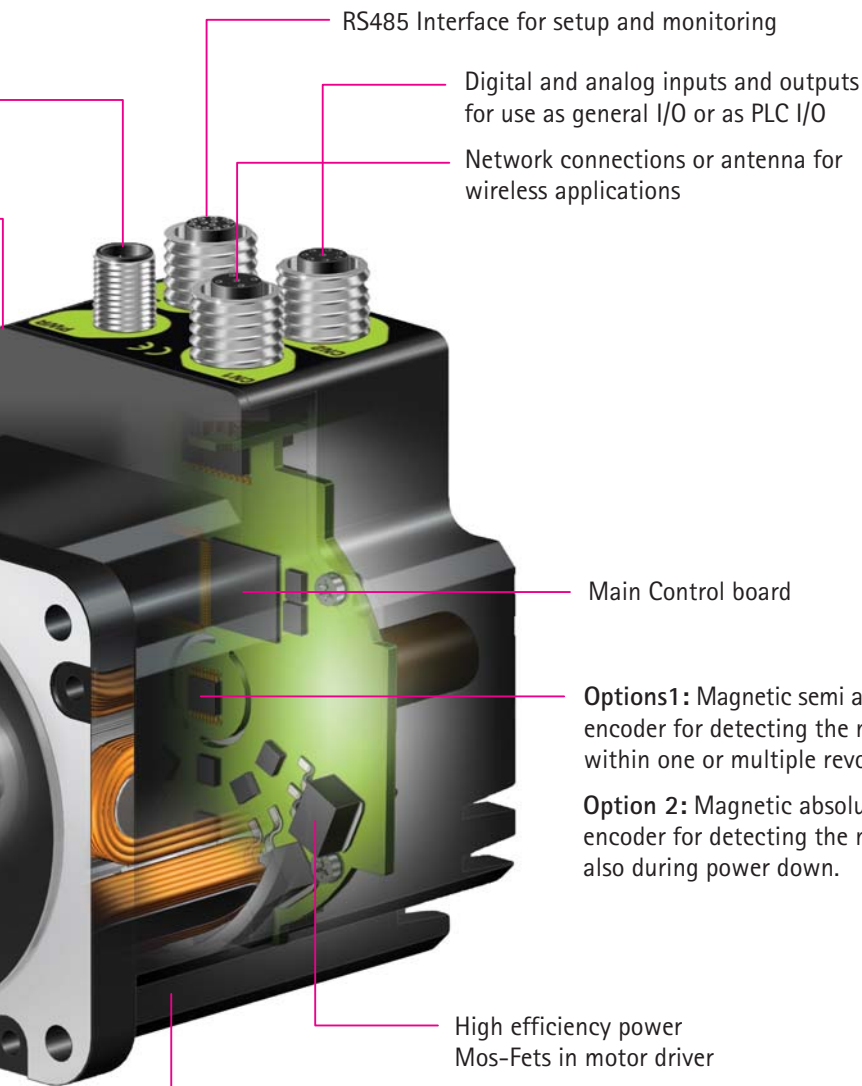

RS485 Interface for setup and monitoring

Digital and analog inputs and outputs for use as general I/O or as PLC I/O

Network connections or antenna for wireless applications

Main Control board

Options1: Magnetic semi absolute multiturn encoder for detecting the motor position within one or multiple revolutions.

Option 2: Magnetic absolute multiturn encoder for detecting the motor position also during power down.

High efficiency power Mos-Fets in motor driver

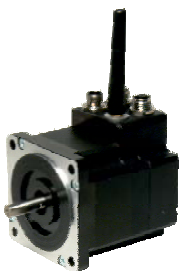

Wireless option

MIS34x with optional wireless communications – Bluetooth, Zigbee or WLAN.
 NB! Same compact dimensions, antenna will only take up one M12 connector



Servo motor range

Please notice that JVL also offers integrated servomotors in the range 50 W up to 3 kW. Please contact your JVL distributor for more information or visit www.jvl.dk

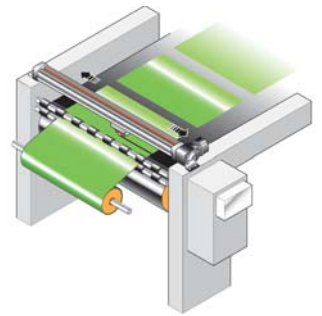

Slitting machines. High speed traverse applications for slicing materials

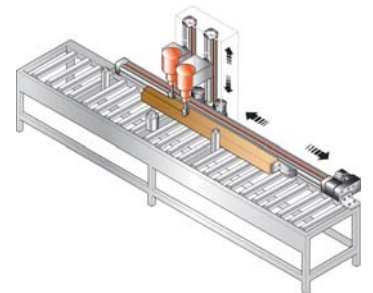

Wood processing machines with vertical and horizontal movements

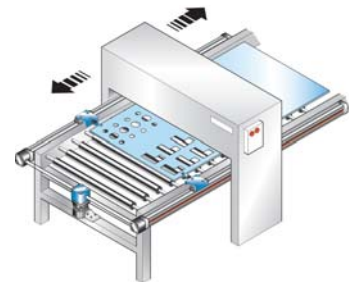

Punching or cutting application

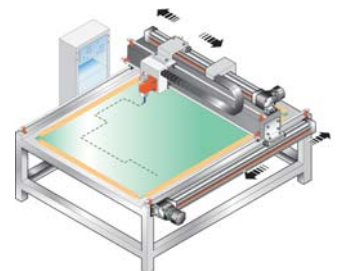

Profile cutting machines intricate profile movements of water jets and laser cutters

Other applications

- Replacement for pneumatic solutions
- Conveyor systems
- Printing machines
- 3-D and XY tables
- Replacement for frequency inverters
- Ball screw and belt driven pick and place robots
- Labelling dispensers

Sold & Serviced By:
ELECTROMATE
 Toll Free Phone (877) 555-0088
 Toll Free Fax (877) 555-0099
www.electromate.com
sales@electromate.com

Software



JVL delivers the software that you need!

MacTalk

For setup, monitoring and diagnostics MacTalk is the preferred choice for most users.

Although advanced functionality is included, all operations are very intuitive and easy to use. Moreover MacTalk is used both for QuickStep and MAC motor® (integrated servo motors).

MacTalk allows you to adjust all vital parameters and save them in a file or load them from a file. It is also possible to monitor parameters and motor status in real time.

When commissioning a system MacTalk even provides a convenient way to test and adjust your system. You can easily set up a test sequence and then adjust parameters like velocity, acceleration and torque. It is possible to select the distance moved and the delay between the moves. Also more advanced parameters are easily adjusted.

A nice feature is the update function: if your PC is connected to the internet you can update the MacTalk software itself – and even the motor system's firmware can be updated. Once bought, MacTalk will stay "fresh" – always including the latest functionality.

Graphical Programming

Like the Nano-PLC in the servo motors (MAC motor®) programming QuickStep is very user friendly, icon-based commands in a graphical programming environment. Each I/O point, which can be defined as input, output or analogue input, can be used in the program. Many commands are available with different kinds of relative or absolute movements, jumps and IF commands, timers and other functions.

It is possible to request input conditions and set outputs. All registers and parameters in the QuickStep motor can be accessed and changed if required.

OCX software

If your application is controlled by a PC you might prefer JVL's OCX software. The OCX (OLE Custom Controls – also known as ActiveX Controls) enables applications to be easily developed for example in:

- Visual Basic
- Visual C++
- Visual .Net
- Delphi
- Borland C++ Builder
- LabView
- Excel

and any other environment supporting OCX controls.

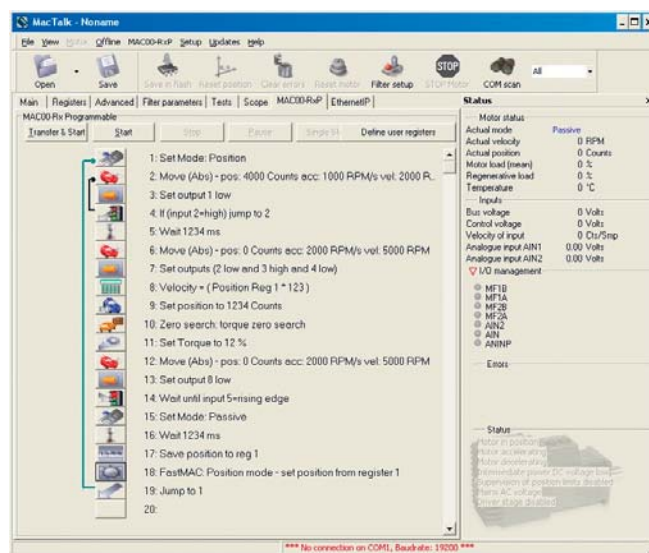
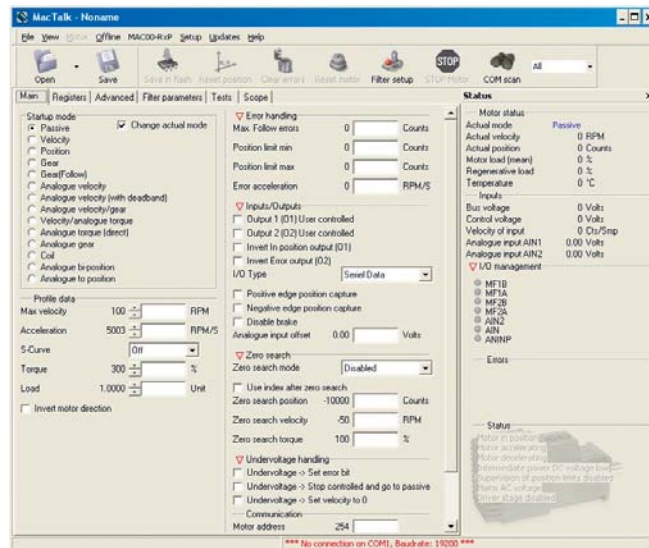

Specifications



							
Main motor type	MIS231	MIS232	MIS234	MIS340	MIS341	MIS342	
Holding torque	1.2 [170]	1.9 [269]	3.3 [425]	3.0 [425]	6.1 [863]	9.0 [1274]	Nm [Oz-In]
Resolution	1600	1600	1600	409600	409600	409600	Counts per rev.
Supply voltage (main)	12-48	12-48	12-48	12-80	12-80	12-80	VDC
Supply voltage (control and main I/O)	12-28	12-28	12-28	12-28	12-28	12-28	VDC
Typical supply current (main) @24 / 48 / 80VDC	2.2 / 2.1 / -	2.2 / 2.2 / -	2.5 / 2.0 / -	5.1 / 5.1 / 5.1	5.6 / 5.3 / 5.6	6.0 / 5.4 / 6.1	ADC RMS
Nominal speed range	0-1023	0-1023	0-1023	0.01 - 3000	0.01 - 3000	0.01 - 3000	RPM
Rated mechanical power (max.)	74	85	77	260	288	315	W
Rotor inertia	0.3 [0.00423]	0.48 [0.00677]	0.96 [0.0135]	1.4 [0.0198]	2.7 [0.0381]	4.0 [0.0564]	kgcm ² [Oz-In-Sec]
Flange dimensions	57x57 [2.3]	57x57 [2.3]	57x57 [2.3]	87x87 [3.4x3.4]	87x87 [3.4x3.4]	87x87 [3.4x3.4]	mm [Inch]
Length	96 [3.78]	118.5 [4.67]	154 [6.06]	95.0 [3.74]	126.0 [4.96]	156.0 [6.14]	mm [inch]
Shaft diameter	6.35 [0.25]	6.35 [0.25]	10.0 [0.3937]	9.53 [0.3752]	9.53 [0.3752]	14.0 [0.5512]	mm [inch]
Weight	0.9 [1.98]	1.23 [2.71]	1.823 [4.02]	2.05 [4.52]	3.13 [6.9]	4.2 [9.26]	kg [lb]
Protection class	IP42 / IP55 (IP67 Optional)						

MIS231, 232 & 234 motor torque versus speed and supply voltage

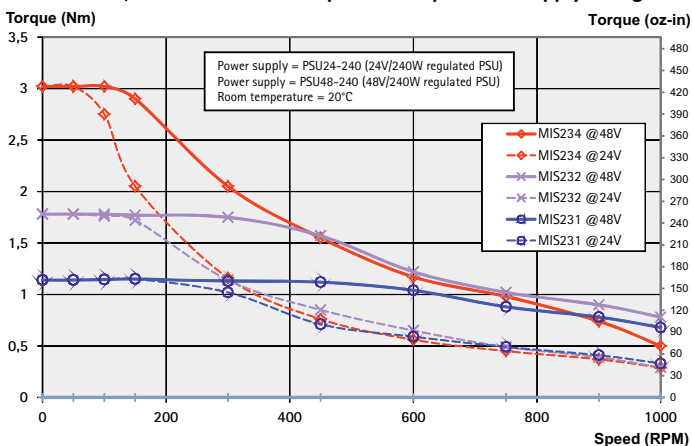

MIS340, 341 & 342 motor torque versus speed and supply voltage

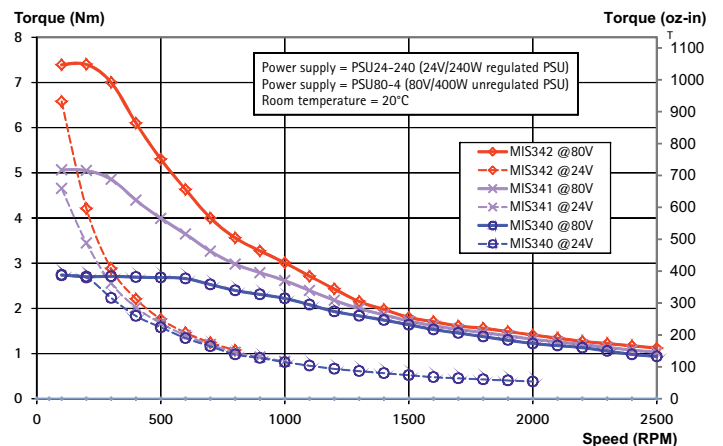

JVL Industri Elektronik A/S

JVL is a motion control company, located in Denmark, just north of Copenhagen. The development, research and production facilities of JVL employ only the latest technology for the development and production of electronic controls for integrated step- and servo motors. More than 50% of the staff are engineers with a very high degree of experience and competence in the field of motion control. We can therefore offer a product

program that includes all the necessary units and components to build up a complete motor control system. JVL is represented throughout Europe and Asia by independent distributors and in USA by a sister company, JVL International ApS. In Germany we have our own office, JVL Deutschland. All distributors are carefully selected by JVL to have the necessary knowledge and experience to help our customers in the best possible way in their choice of motion control components.



...integration in motion

JVL Industri Elektronik A/S
Blokken 42
DK-3460 Birkerød, Denmark
Tel: +45 4582 4440
Fax: +45 4582 5550
E-mail: jvl@jvl.dk
www.jvl.dk

JVL Deutschland
Tel: +49 711 51878564
Fax: +49 711 51878565
E-mail: jan.tausend@jvl.de
www.jvl drives.de

JVL USA
JVL International
Tel: +1 513 877 3134
Fax: +1 513 877 2471
E-mail: jvl@jvlusa.com
www.jvlusa.com

 ELECTROMATE
Toll Free Phone (877) SERV098
Toll Free Fax (877) SERV098
www.electromate.com
sales@electromate.com