



Quality and Innovation

Mini ROBO Cylinder

RCP3

RCA2

RCS2

RCL

Variations have been expanded with:

- Additional RCS2 series
- Additional Stroke 50/75 mm
- Additional Controller SCON-CA

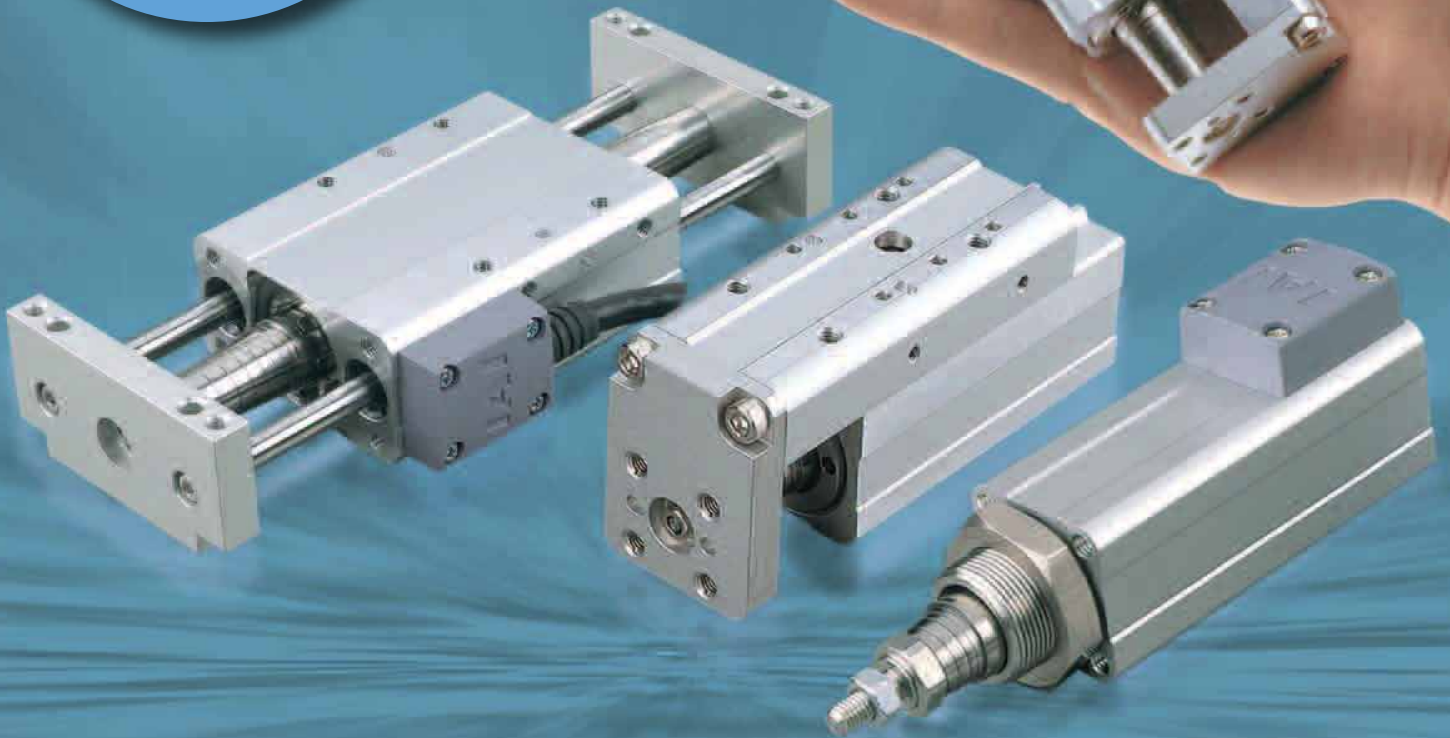

Sold & Serviced By:

 **ELECTROMATE**





Toll Free Phone (877) SERV098





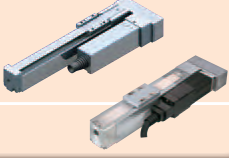
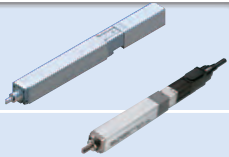
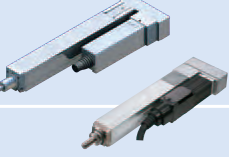

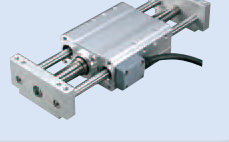

Toll Free Fax (877) SERV099

www.electromate.com

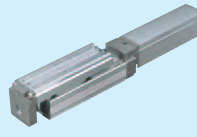
sales@electromate.com

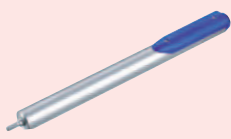
Product Overview	Contents	0-01	Specification Table	0-09
	Features	0-03	Model Descriptions	0-14
	Controller Features	0-07		

Category	Type	Title / External view	Model		Actuator width	Maximum payload (horizontal)	Reference Page		
			Series Name	Type name					
Slider type	Motor Unit type	Coupling type		RCP3	SA2AC	22mm	1kg	→P.17	
					SA2BC	28mm	1kg	→P.19	
			RCA2	SA2AC	20mm	2kg	→P.25		
		Side-Mounted Motor type		RCP3	SA2AR	58mm	1kg	→P.21	
					SA2BR	59.5mm	1kg	→P.23	
				RCA2	SA2AR	41mm	2kg	→P.27	
Rod type	Without guide	Coupling type		RCP3	RA2AC	22mm	4kg	→P.29	
					RA2BC	28mm	8kg	→P.31	
			RCA2	RA2AC	18mm	2kg	→P.37		
		Side-Mounted Motor type		RCP3	RA2AR	58mm	4kg	→P.33	
					RA2BR	59.5mm	8kg	→P.35	
				RCA2	RA2AR	41mm	2kg	→P.39	
		Short Length type	Fixed Nut type		RCA2	RN3NA	28mm	3kg	→P.41
						RN4NA	34mm	6kg	→P.43
					NEW RCS2	RN5N	46mm	20kg	→P.45
	Tapped Hole type			RCA2	RP3NA	28mm	3kg	→P.47	
					RP4NA	34mm	6kg	→P.49	
				NEW RCS2	RP5N	46mm	20kg	→P.51	
	With guide	Short Length type	Single-guide type		RCA2	GS3NA	28mm	3kg	→P.53
						GS4NA	34mm	6kg	→P.55
					NEW RCS2	GS5N	46mm	20kg	→P.57
		Double-guide type		RCA2	GD3NA	28mm	3kg	→P.59	
					GD4NA	34mm	6kg	→P.61	
				NEW RCS2	GD5N	46mm	20kg	→P.63	
Slide unit type			RCA2	SD3NA	60mm	3kg	→P.65		
				SD4NA	72mm	6kg	→P.67		
			NEW RCS2	SD5N	94mm	20kg	→P.69		

Category	Type	Title / External view	Model		Actuator width	Maximum payload (horizontal)	Reference Page		
			Series Name	Type name					
Table type	Short Length type	Compact type		RCA2	TCA3NA	32mm	3kg	→P.71	
					TCA4NA	36mm	6kg	→P.73	
				NEW RCS2	TCA5N	48mm	20kg	→P.75	
		Wide type		RCA2	TWA3NA	50mm	3kg	→P.77	
					TWA4NA	58mm	6kg	→P.79	
				NEW RCS2	TWA5N	80mm	20kg	→P.81	
		Flat type		RCA2	TFA3NA	61mm	3kg	→P.83	
					TFA4NA	71mm	6kg	→P.85	
				NEW RCS2	TFA5N	95mm	20kg	→P.87	
	Motor Unit type	Coupling type		RCP3	TA3C	36mm	2kg	→P.89	
					TA4C	40mm	3kg	→P.91	
				RCA2	TA4C	40mm	3kg	→P.93	
		Side-Mounted Motor type		RCP3	TA3R	72mm	2kg	→P.95	
					TA4R	81mm	3kg	→P.97	
				RCA2	TA4R	81mm	3kg	→P.99	
Linear servo type	Micro Slider	Slim type		RCL	SA1L	20mm	0.5kg	→P.101	
					SA2L	24mm	1kg	→P.103	
					SA3L	28mm	2kg	→P.105	
		Long Stroke type			Single slider	SA4L	40mm	0.8kg	→P.107
						SA5L	48mm	1.6kg	→P.111
						SA6L	58mm	3.2kg	→P.115
					Multi-slider	SM4L	40mm	0.8kg	→P.109
						SM5L	48mm	1.6kg	→P.113
						SM6L	58mm	3.2kg	→P.117
	Micro Cylinder	Slim type		RCL	RA1L	ø16mm	0.5kg	→P.119	
					RA2L	ø20mm	1kg	→P.121	
					RA3L	ø25mm	2kg	→P.123	
Controller	PMEC/AMEC Controller						→P.131		
	PSEP/ASEP Controller						→P.141		
	SCON-CA Controller NEW						→P.157		

Sold & Serviced By:

ELECTROMATE

Toll Free Phone (877) SERV098

Toll Free Fax (877) SERV099

www.electromate.com

sales@electromate.com

The compact, next-generation electric actuator

Mini ROBO Cylinder



Mini ROBO Cylinder (space-saving)

The Mini ROBO Cylinder is an achievement in small electromechanical cylinders. It incorporates a newly developed motor, and its significantly reduced length, width and height make it comparable in size to air cylinders. The Mini ROBO Cylinder is the perfect replacement for air cylinders in systems that previously could only use air cylinders due to size constraints.

The Mini Table Compact type RCA2-TCA3NA has dimensions smaller than a business card.

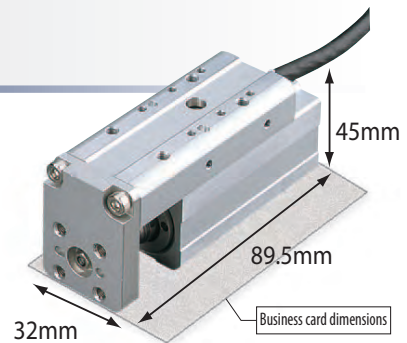

Shaped like an air cylinder and easy to use

The Mini ROBO Cylinder is available in shapes similar to air cylinders.

Users accustomed to the operation of pneumatic systems are able to use the new ROBO Cylinder effortlessly.

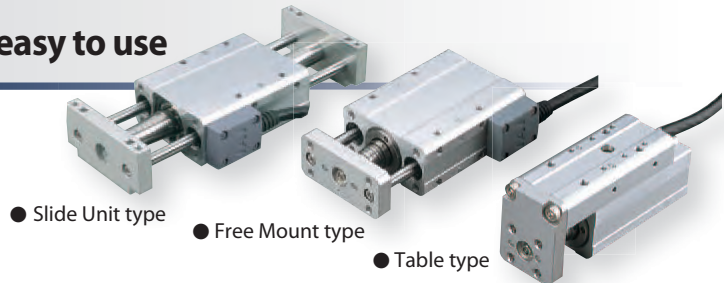

Expanded Variations

New models have been added, including slim types with contracted actuator width and high-payload, long-stroke types of 46 mm in actuator width, to support greater applications.

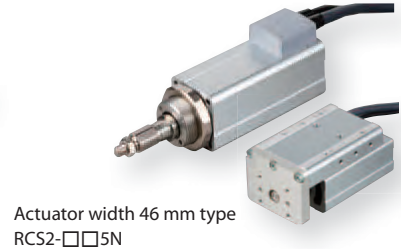
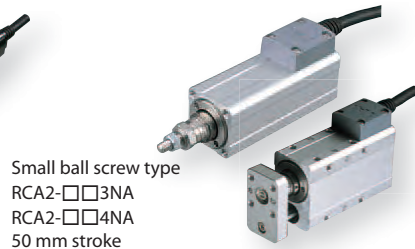
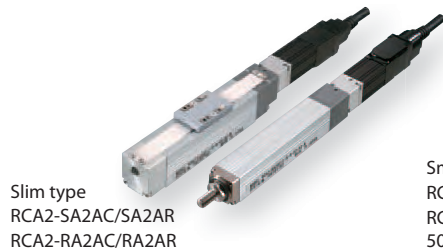

<List of existing ROBO Cylinder models and new ROBO Cylinder models>

		Models featured in this catalog		Existing Models		
Slider type	Name	Motor unit type	Motor unit type	Coupling type	Coupling type	Coupling type
	Type	SA2AC/SA2BC	SA3C/SA4C/SA5C/SA6C	SA5C/SA6C/SA7C/SS7C/SS8C	SA4C/SA5C/SA6C	SA4C/SA5C/SA6C/SA7C/SS7C/SS8C
Rod type	Name	Motor unit type	Coupling type	Coupling type	Full length short type	High thrust type
	Type	RA2AC/RA2BC	RA3C/RA4C/RA6C	RA3C/RA4C/RA5C	SRA7BD	RA10C
Table type	Name	Motor unit type	Motor unit type			
	Type	TA3C/TA4C	TA5C/TA6C/TA7C			
Linear Servo type	Name	Micro cylinder	Micro-slider (slim)	Micro-slider (long)	Multi-slider	
	Type	RA1L/RA2L/RA3L	SA1L/SA2L/SA3L	SA4L/SA5L/SA6L	SM4L/SM5L/SM6L	
Side-mounted motor type	Name	Side-mounted motor type	Side-mounted motor type	Side-mounted motor type	Side-mounted motor type	Side-mounted motor type
	Type	SA2AR/SA2BR	SA3R/SA4R/SA5R/SA6R	SA5R/SA6R/SA7R/SS7R/SS8R	SA4R/SA5R/SA6R	SA4R/SA5R/SA6R/SA7R/SS7R/SS8R
Single guide type	Name	Single guide type	Single guide type	Single guide type	Single guide type	Single guide type, short
	Type	GS3NA/GS4NA/GS5N	RGS4C/RGS6C	RGS3C/RGS4C	RG55C	SRGS4R/SRGS7BD
Double guide type	Name	Double guide type	Double guide type	Double guide type	Double guide type	Double guide type, short
	Type	GD3NA/GD4NA/GD5N	RGD4C/RGD6C	RGD3C/RGD4C	RGD5C	SRGD4R/SRGD7BD
Slide unit type	Name	Slide unit type				
	Type	SD3NA/SD4NA/SD5N				
Compact type	Name	Compact type	Wide type	Flat type		
	Type	TCA3NA/TCA4NA/TCA5N	TWA3NA/TWA4NA/TWA5N	TFA3NA/TFA4NA/TFA5N		

*The type code indicates the width of the actuator. Take note that actuators of the same type code have different dimensions depending on the model. For details, refer to the drawings for each type.

type	Actuator width
2A	22mm
2B	28mm
3	28~36mm
4	34~45mm
5	48~55mm
6	58~64mm
7	71~75mm
8	80mm
10	100mm
13	130mm

*"Pulse (24V)", "Servo (24V)" and "Servo (100/200V)" indicate motor types.

Pulse (24V) → RCP3/RCP2 series
 Servo (24V) → RCL/RCA2/RCA series
 Servo (100V/200V) → RCS2 series

Mini Slider type

The slider on the main body moves back and forth until it is positioned.

- Features**
- The motor can easily perform switching operations for the unit model.
 - Select from Side-Mounted Motor type with a reduced total length and Slim Straight type (Coupling type).

Usage Used for jig and workpiece positioning, table travel, etc

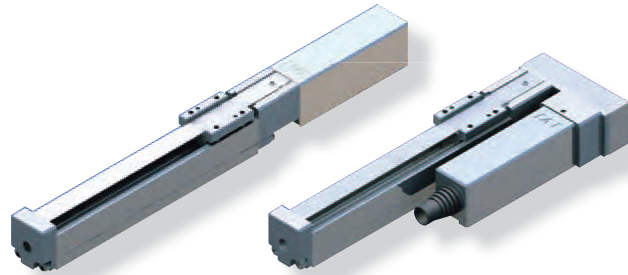

Motor Unit Coupling type

Side-Mounted Motor type

Mini Rod type

The rod extends and retracts from the main body, gets into position and presses.

- Features**
- Select from Slim Motor Unit types and Short Length types having greatly reduced overall length.
 - Select from Guide types with highly rigid/linear built-in guides and those without guides having drastically miniaturized main body sizes.

Usage Used for raising/lowering products and jigs, pushing, clamping, etc.

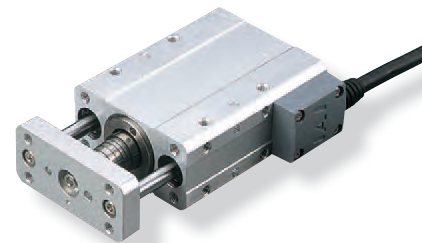

Short Length,
Double-Guide
Free Mount type

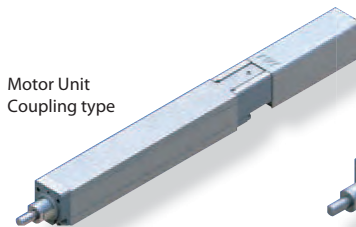

Motor Unit
Coupling type

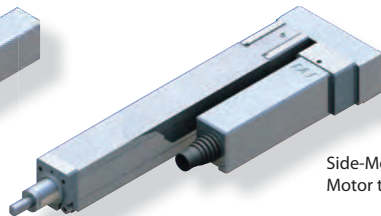

Side-Mounted
Motor type

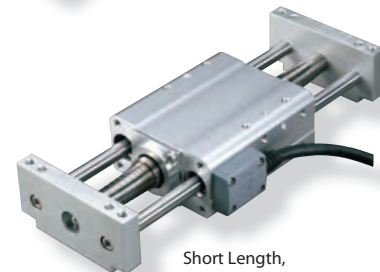

Short Length,
Double-Guide
Slide Unit type

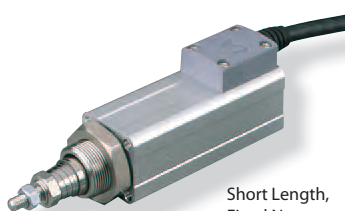

Short Length,
Fixed Nut type

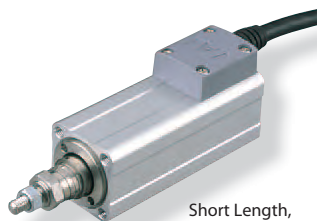

Short Length,
Tapped Hole type

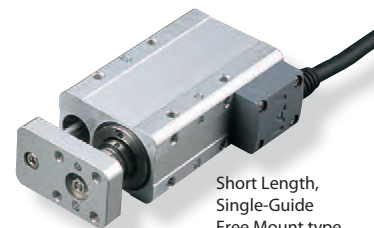

Short Length,
Single-Guide
Free Mount type

Mini Table type

The table on the main body slides until it is positioned.

- Features**
- Comes equipped with an integrated guide that keeps overhung loads balanced.
 - Select from Compact, Short Length types and Long Stroke Motor Unit types.
- Usage**
- Used for raising/lowering products and jigs, horizontal moving, and pushing (handles overhung loads from the main unit).

Side-Mounted Motor type

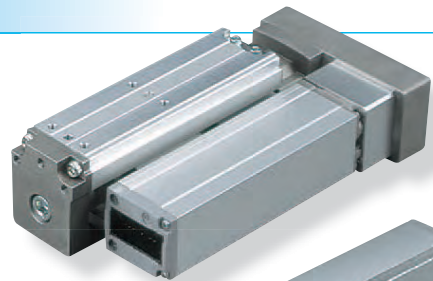

Motor Unit Coupling type

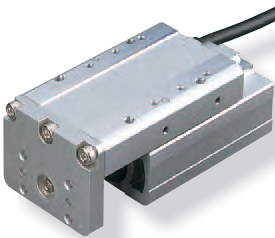
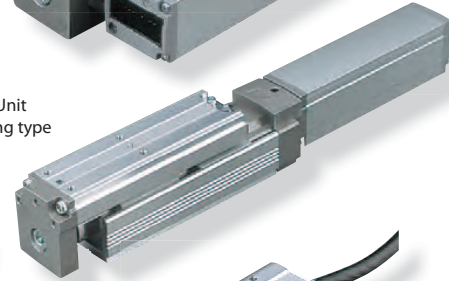

Short Length Wide type

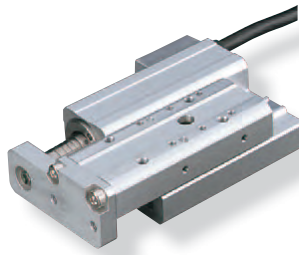

Short Length Flat type

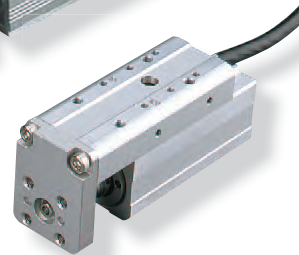

Short Length Compact type

Mini Linear Servo type

High speed, lightweight parts transfer.

- Features**
- Equipped with a high acceleration/ deceleration linear motor capable of operation at up to 2G.
 - Available in Slider type and Rod type. Slider type comes in six different models for each size and stroke.
 - The Multi-slider type comes with two sliders on one actuator that can be independently operated.
- Usage**
- Used for transfers requiring short cycle times, etc.

Micro Slider Slim type

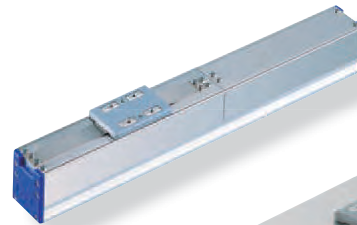

Micro Slider Long Stroke Type single slider

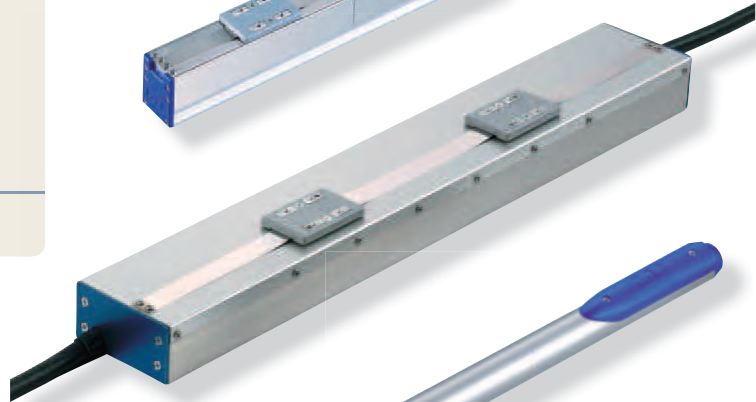
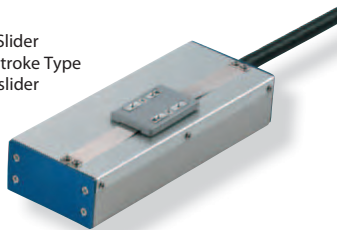

Micro Slider Long Stroke Type Multi-slider



Micro Cylinder Slim type

Controller













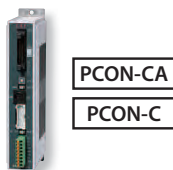
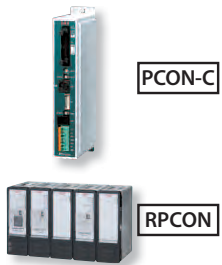

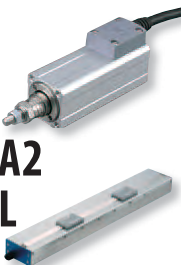
Lineup of models meeting various applications, from 3-point positioning types controlled like solenoid valves to network types

You can choose a desired controller from those of various control methods, such as 3-point positioning types whose teaching and trial operation can be done using the controller's operation panel, multi-point positioning types supporting up to 512 positioning points, and network types that can be connected to various networks.

Since 3-point positioning types (3 position controller) can be operated with the same signal as the ones of solenoid valves, the device with the currently used air device can be changed to an electric cylinder. (Refer to the page on the right for details.)

Refer to the table below for the various actuator models (series) and controllers that can be connected.

Type of controller	Positioner type		Network type	Program type
	3-position controller	512-position controller		
Features	<ul style="list-style-type: none"> Easy to operate, as the actuator can be operated simply by turning signals ON/OFF. Can be operated using the same signals used for solenoid valves. 	<ul style="list-style-type: none"> Multi-point positioning to 512 points is possible. Pulse-train control is also supported. 	<ul style="list-style-type: none"> Directly connectable to key field networks. Coordinate values can be specified directly using numeric values to move the actuator. The current position and axis condition can be checked with a host device. 	<ul style="list-style-type: none"> Standalone operation is possible without using a PLC or other host device. Simultaneous control of up to 2 axes (PSEL, ASEL, SSEL) or six axes (XSEL) is possible.
 <p>RCP3</p>	 <p>PMEC PSEP</p>	 <p>PCON-CA PCON-C</p>	 <p>PCON-C RPCON</p>	 <p>PSEL</p>
 <p>RCA2 RCL</p>	 <p>AMEC ASEP</p>	 <p>ACON-C</p>	 <p>ACON-C RACON</p>	 <p>ASEL</p>
 <p>RCS2</p>	/	 <p>SCON-CA</p>	 <p>SCON-CA</p>	 <p>SSEL XSEL</p>

New PMEC/AMEC, PSEP/ASEP controllers designed exclusively for 2-point and 3-point positioning



Unlike conventional controllers, the PMEC/AMEC, PSEP/ASEP require only a few movement positions. These "Simple, Easy Positioner" controllers are for applications where the actuator travels only between two or three points, which is usually the case with air cylinders.

PMEC/AMEC controllers come with an operation panel to let you set the stop position, speed and acceleration/deceleration and perform test operation, so those who are not experts in electrical wiring can also set/adjust ROBO cylinder operations with ease.

Operates using the same signals used for air cylinder solenoid valves.

PMEC/AMEC, PSEP/ASEP operating methods

PMEC/AMEC, PSEP/ASEP controllers can be operated with the same signals used for air cylinder solenoid valves.

Solenoid valves come in two types: Single solenoids and Double solenoids. The PMEC/AMEC, PSEP/ASEP supports signals for both.

When using an air cylinder solenoid valve:

<Single solenoid>

(Air cylinder)

Solenoid 1

(Solenoid valve)

Signal to solenoid 1	Rod movement
ON	Front end
OFF	Rear end

<Double solenoid>

(Air cylinder)

Solenoid 1

Solenoid 2

(Solenoid valve)

Signal to solenoid 1	Signal to solenoid 2	Rod movement
ON	OFF	Front end
OFF	ON	Rear end

PMEC/AMEC, PSEP/ASEP:

<Replacement of single solenoid>

(ROBO Cylinder)

*Desired positions for front end and rear end can be freely set.

(PMEC/AMEC, PSEP/ASEP)

Signal to controller Input 0	Rod movement
ON	Front end
OFF	Rear end

<Double solenoid>

(ROBO Cylinder)

(PMEC/AMEC, PSEP/ASEP)

Signal to controller Input 1	Signal to controller Input 0	Rod movement
ON	OFF	Front end
OFF	ON	Rear end

* The main body moves between the same two points listed above, but it can also travel between three points by switching the parameters.

Specification Table



Slider type																					
Type	Title / External view	Model		Encoder	Motor type		Feed screw	Lead (mm)	Rated thrust (N)	Max. payload (kg)		Max. speed (mm/s)	Stroke (mm)	Positioning repeatability (mm)	Reference Pages						
		Series Name	Type name		Type	Size				Horizontal	Vertical										
Motor Unit model	Coupling type 	RCP3	SA2AC	Incremental	Pulse motor	20□	Lead screw	4	—	0.25	—	200	25~100 (every 25)	±0.05	P.17						
			2					—	0.5	—	100										
		SA2BC	1					—	1	—	50	25~150 (every 25)				±0.02	P.19				
			6					—	0.25	—	300										
		RCA2	SA2AC					4	21.4	0.5	0.25							200	25~100 (every 25)	±0.02	P.25
								2	42.3	1	0.5							100			
	1	85.5	2		1	50															
	Side-Mounted Motor type 	RCP3	SA2AR		Incremental	Pulse motor	20□	Lead screw	4	—	0.25		—	200	25~100 (every 25)			±0.05			
			2						—	0.5	—	100									
		SA2BR	1						—	1	—	50	25~150 (every 25)	±0.02		P.23					
			6						—	0.25	—	300									
		RCA2	SA2AR						4	21.4	0.5	0.25					200		25~100 (every 25)	±0.02	P.27
2				42.3					1	0.5	100										
1	85.5	2	1	50																	

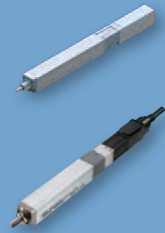

Mini Rod type																			
Type	Title / External view	Model		Encoder	Motor type		Feed screw	Lead (mm)	Rated thrust (N)	Max. payload (kg)		Max. speed (mm/s)	Stroke (mm)	Positioning repeatability (mm)	Reference Pages				
		Series Name	Type name		Type	Size				Horizontal	Vertical								
Motor Unit model	Coupling type 	RCP3	RA2AC	Incremental	Pulse motor	20□	Lead screw	4	—	0.25	0.125	200	25~100 (every 25)	±0.05	P.29				
								2	—	0.5	0.25	100							
								1	—	1	0.5	50				25~150 (every 25)	±0.02	P.31	
								Ball screw	4	—	0.5	0.2							200
									1	—	2	0.75							50
								20□ High thrust	4	—	1	0.325							200
			2			—	2		0.625	100									
			1			—	4	1.25	50										
			RA2BC			Lead screw	6	—	0.25	0.125	300	25~150 (every 25)	±0.02	P.31					
							4	—	0.5	0.25	200								
							2	—	1	0.5	100								
						Ball screw	6	—	0.5	0.2	300								
		4			—		1	0.375	200										
		2			—		2	0.75	100										
		20□ High thrust	1		—	4	1.5	50	25~100 (every 25)	±0.02	P.37								
			6		—	1	0.325	300											
			4		—	2	0.625	200											
		RCA2	RA2AC		Servo motor	5W	Ball screw	4				21.4	0.5	0.25	200	25~100 (every 25)	±0.02	P.37	
2	42.3			1				0.5				100							
1	85.5			2				1				50							

0-09

Product Features

■ Skillful use of the "Lead Screw" type

- (1) Lead screws are suitable for uses with infrequent operations. (As a guide, this would be approximately 5 years, for 1 operation every 10 seconds, 24-hour use, 240 days a year.)
- (2) Lead screws are suitable for uses with small payloads, light loads. (1kg or less)
- (3) Use when repeated positioning accuracy of less than ±0.05mm is needed.
- (4) Please set up in a location where maintenance will be easy.



Rod type																					
Type	Title / External view	Model		Encoder	Motor type		Feed screw	Lead (mm)	Rated thrust (N)	Max. payload (kg)		Max. speed (mm/s)	Stroke (mm)	Positioning repeatability (mm)	Reference Pages						
		Series Name	Type name		Type	Size				Horizontal	Vertical										
Motor Unit model	 <p>Side-Mounted Motor type</p>	RCP3	RA2AR	Incremental	Pulse motor	20□	Lead screw	4	—	0.25	0.125	200	25~100 (every 25)	±0.05	P.33						
							2	—	0.5	0.25	100										
							1	—	1	0.5	50										
						4	—	0.5	0.2	200											
						2	—	1	0.375	100											
						1	—	2	0.75	50											
			20□ High thrust		Ball screw	4	—	1	0.325	200											
					2	—	2	0.625	100												
					1	—	4	1.25	50												
			RA2BR		20□	Lead screw	6	—	0.25	0.125	300	25~150 (every 25)	±0.05								
						4	—	0.5	0.25	200											
						2	—	1	0.5	100											
		6		—	0.5	0.2	300														
		4		—	1	0.375	200														
		2		—	2	0.75	100														
		Ball screw	1	—	4	1.5	50														
			6	—	1	0.325	300														
			4	—	2	0.625	200														
20□ High thrust	2	—	4	1.25	100																
	1	—	8	2.5	50																
	RCA2	RA2AR	Servo motor	5W	Incremental	Ball screw	4	21.4	0.5	0.25	200	25~100 (every 25)	±0.02	P.39							
2							42.3	1	0.5	100											
1							85.5	2	1	50											
Short Length type		 <p>Fixed Nut type</p>		RCA2		RN3NA	Incremental	Servo motor (24V)	10W	Lead screw	4				25.1	0.25	0.125	200	30 50 New	±0.05	P.41
										2	50.3				0.5	0.25	100				
										1	100.5				1	0.5	50				
4	42.7		0.75		0.25	200															
2	85.5		1.5		0.5	100															
1	170.9		3		1	50															
Ball screw	6		19.9	0.25	0.125	220		30 50 New	±0.05												
	4		29.8	0.5	0.25	200															
	2		59.7	1	0.5	100															
6	33.8		2	0.5	270(220)																
4	50.7		3	0.75	200																
2	101.5		6	1.5	100																
RCA2	RN4NA	Servo motor (200V)	60W	Incremental	Ball screw	10	89	5	1.5	380(330)	50 75	±0.02	P.45								
						5	178	10	3	250											
						2.5	356	20	6	125											
	RP3NA		Servo motor (24V)		10W	Incremental	Lead screw	4	25.1	0.25				0.125	200	30 50 New	±0.05	P.47			
								2	50.3	0.5				0.25	100						
								1	100.5	1				0.5	50						
4	42.7	0.75		0.25	200																
2	85.5	1.5		0.5	100																
1	170.9	3		1	50																
RP4NA	20W	Servo motor (200V)	Incremental	Lead screw	6	19.9	0.25	0.125	220	30 50 New	±0.05	P.49									
					4	29.8	0.5	0.25	200												
					2	59.7	1	0.5	100												
	6			33.8	2	0.5	270(220)														
	4			50.7	3	0.75	200														
	2			101.5	6	1.5	100														
New RCS2	RP5N	Servo motor (200V)	Incremental	Ball screw	10	89	5	1.5	380(330)	50 75	±0.02	P.51									
					5	178	10	3	250												
					2.5	356	20	6	125												

*The value inside < > indicates vertical usage.

Continue to the next page

Specification Table





Rod type																							
Type	Title / External view	Model		Encoder	Motor type		Feed screw	Lead (mm)	Rated thrust (N)	Max. payload (kg)		Max. speed (mm/s)	Stroke (mm)	Positioning repeatability (mm)	Reference Pages								
		Series Name	Type name		Type	Size				Horizontal	Vertical												
Short Length type	Single-Guide type 	RCA2	GS3NA	Incremental	Servo motor (24V)	10W	Lead screw	4	25.1	0.25	0.125	200	30 50	±0.05	P.53								
								2	50.3	0.5	0.25	100											
								1	100.5	1	0.5	50											
							Ball screw	4	42.7	0.75	0.25	200											
								2	85.5	1.5	0.5	100											
								1	170.9	3	1	50											
		RCS2	GS4NA		Lead screw	6	19.9	0.25	0.125	220	30 50	±0.05											
						4	29.8	0.5	0.25	200													
						2	59.7	1	0.5	100													
					Ball screw	6	33.8	2	0.5	270(220)													
						4	50.7	3	0.75	200													
						2	101.5	6	1.5	100													
	New	GS5N	Servo motor (200V)	60W	Ball screw	10	89	5	1.5	380(330)	50 75	±0.02	P.57										
						5	178	10	3	250													
						2.5	356	20	6	125													
						Double-Guide type 	RCA2	GD3NA	Incremental	Servo motor (24V)				10W	Lead screw	4	25.1	0.25	0.125	200	30 50	±0.05	P.59
																2	50.3	0.5	0.25	100			
																1	100.5	1	0.5	50			
	Ball screw	4	42.7	0.75	0.25						200												
		2	85.5	1.5	0.5						100												
		1	170.9	3	1						50												
	RCS2	GD4NA	Lead screw	6	19.9		0.25	0.125		220	30 50	±0.05											
				4	29.8		0.5	0.25		200													
				2	59.7		1	0.5		100													
Ball screw			6	33.8	2		0.5	270(220)															
			4	50.7	3		0.75	200															
			2	101.5	6		1.5	100															
New	GD5N	Servo motor (200V)	60W	Ball screw	10	89	5	1.5	380(330)	50 75	±0.02	P.63											
					5	178	10	3	250														
					2.5	356	20	6	125														
					Double-Guide Slide Unit type 	RCA2	SD3NA	Incremental	Servo motor (24V)				10W	Lead screw	4	25.1	0.25	0.125	200	25 50	±0.05	P.65	
															2	50.3	0.5	0.25	100				
															1	100.5	1	0.5	50				
Ball screw	4	42.7	0.75	0.25						200													
	2	85.5	1.5	0.5						100													
	1	170.9	3	1						50													
RCS2	SD4NA	Lead screw	6	19.9		0.25	0.125		300	25 50 75	±0.05												
			4	29.8		0.5	0.25		200														
			2	59.7		1	0.5		100														
		Ball screw	6	33.8		2	0.5		300														
			4	50.7		3	0.75		200														
			2	101.5		6	1.5		100														
New	SD5N	Servo motor (200V)	60W	Ball screw	10	89	5	1.5	380(330)	50 75	±0.02	P.69											
					5	178	10	3	250														
					2.5	356	20	6	125														

*The value inside <> indicates vertical usage.

■ Skillful use of the "Lead Screw" type

- (1) Lead screws are suitable for uses with infrequent operations. (As a guide, this would be approximately 5 years, for 1 operation every 10 seconds, 24-hour use, 240 days a year.)
- (2) Lead screws are suitable for uses with small payloads, light loads. (1kg or less)
- (3) Use when repeated positioning accuracy of less than ±0.05mm is needed.
- (4) Please set up in a location where maintenance will be easy.

Table type															
Type	Title / External view	Model		Encoder	Motor type		Feed screw	Lead (mm)	Rated thrust (N)	Max. payload (kg)		Max. speed (mm/s)	Stroke (mm)	Positioning repeatability (mm)	Reference Pages
		Series Name	Type name		Type	Size				Horizontal	Vertical				
Short Length type	Compact type 	RCA2	TCA3NA	Incremental	Servo motor (24V)	10W	Lead screw	4	25.1	0.25	0.125	200	30	±0.05	P.71
								2	50.3	0.5	0.25	100			
								1	100.5	1	0.5	50			
							Ball screw	4	42.7	0.75	0.25	200	50 New	±0.02	
								2	85.5	1.5	0.5	100			
								1	170.9	3	1	50			
		TCA4NA	Lead screw		6	19.9	0.25	0.125	220	30	±0.05				
					4	29.8	0.5	0.25	200						
					2	59.7	1	0.5	100						
			Ball screw		6	33.8	2	0.5	270(220)			50 New	±0.02		
					4	50.7	3	0.75	200						
					2	101.5	6	1.5	100						
	New RCS2	TCA5N	Servo motor (200V)	60W	Ball screw	10	89	5	1.5	380(330)	50 75	±0.02	P.75		
						5	178	10	3	250					
						2.5	356	20	6	125					
	Wide type 	RCA2	TWA3NA	Incremental	Servo motor (24V)	10W	Lead screw	4	25.1	0.25	0.125	200	30	±0.05	P.77
								2	50.3	0.5	0.25	100			
								1	100.5	1	0.5	50			
							Ball screw	4	42.7	0.75	0.25	200	50 New	±0.02	
								2	85.5	1.5	0.5	100			
								1	170.9	3	1	50			
		TWA4NA	Lead screw		6	19.9	0.25	0.125	220	30	±0.05				
					4	29.8	0.5	0.25	200						
					2	59.7	1	0.5	100						
Ball screw			6		33.8	2	0.5	270(220)	50 New			±0.02			
			4		50.7	3	0.75	200							
			2		101.5	6	1.5	100							
New RCS2	TWA5N	Servo motor (200V)	60W	Ball screw	10	89	5	1.5	380(330)	50 75	±0.02	P.81			
					5	178	10	3	250						
					2.5	356	20	6	125						
Flat type 	RCA2	TFA3NA	Incremental	Servo motor (24V)	10W	Lead screw	4	25.1	0.25	0.125	200	30	±0.05	P.83	
							2	50.3	0.5	0.25	100				
							1	100.5	1	0.5	50				
						Ball screw	4	42.7	0.75	0.25	200	50 New	±0.02		
							2	85.5	1.5	0.5	100				
							1	170.9	3	1	50				
	TFA4NA	Lead screw		6	19.9	0.25	0.125	220	30	±0.05					
				4	29.8	0.5	0.25	200							
				2	59.7	1	0.5	100							
		Ball screw		6	33.8	2	0.5	270(220)			50 New	±0.02			
				4	50.7	3	0.75	200							
				2	101.5	6	1.5	100							
New RCS2	TFA5N	Servo motor (200V)	60W	Ball screw	10	89	5	1.5	380(330)	50 75	±0.02	P.87			
					5	178	10	3	250						
					2.5	356	20	6	125						

*The value inside < > indicates vertical usage.



Continue to the next page

Specification Table

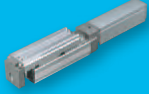
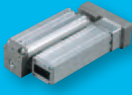

Table type															
Type	Title / External view	Model		Encoder	Motor type		Feed screw	Lead (mm)	Rated thrust (N)	Max. payload (kg)		Max. speed (mm/s)	Stroke (mm)	Positioning repeatability (mm)	Reference Pages
		Series Name	Type name		Type	Size				Horizontal	Vertical				
Motor Unit model	Coupling type 	RCP3	TA3C	Incremental	Pulse motor	20□	Ball screw	6	-	~0.7	~0.3	300(200)	20~100 (every 10)	±0.02	P.89
			4					-	~1.4	~0.6	200(133)				
			2					-	~2	~1	100(67)				
		RCA2	TA4C		Servo motor	10W		6	-	~1	~0.5	300			
			4					-	~2	~1	200				
			2					-	~3	~1.5	100				
	Side-Mounted Motor type 	RCP3	TA3R		Pulse motor	20□	Ball screw	6	-	~0.7	~0.3	300(200)			
			4					-	~1.4	~0.6	200(133)				
			2			-		~2	~1	100(67)					
			TA4R			6		-	~1	~0.5	300				
		4			-	~2		~1	200						
		RCA2	TA4R		Servo motor	10W		2	-	~3	~1.5	100			
				6				-	1	0.5	300				
				4				-	2	1	200				
2	-			3			1.5	100							

*The value inside <> indicates vertical usage.

Linear servo type																						
Type	Title / External view	Model		Encoder	Motor type		Feed screw	Lead (mm)	Rated thrust (N)	Max. payload (kg)		Max. speed (mm/s)	Stroke (mm)	Positioning repeatability (mm)	Reference Pages							
		Series Name	Type name		Type	Size				Horizontal	Vertical											
Micro Slider	Slim type 	RCL	SA1L	Incremental	Linear motor	-	-	-	2	0.5	-	420	40	±0.1	P.101							
			SA2L					5W	-	4	1	-	460		48	P.103						
			SA3L					10W	-	8	2	-	600		64	P.105						
	Long Stroke type 		SA4L					2W	-	2.5	0.8	-	1200		30~180 (every 30)	P.107						
			SM4L					2W	-	-	-	-	1200		30~120 (every 30)	P.109						
			SA5L					5W	-	5	1.6	-	1400		36~216 (every 36)	P.111						
			SMSL					5W	-	-	-	-	1400		36~144 (every 36)	P.113						
	Micro Cylinder		Slim type 					SA6L	Incremental	Linear motor	-	-	-		10	3.2	-	1600	48~288 (every 48)	±0.1	P.115	
								SM6L					10W						-		48~192 (every 48)	P.117
								RA1L					2W						-		2.5	0.5
RA2L		5W		-	5	1	0.2	340					30	P.121								
RA3L		10W		-	10	2	0.4	450					40	P.123								

Model Descriptions



Models for each ROBO Cylinder series are designated by the items below.

See the explanations below for information on each item. The range of selections for each item (lead, stroke, etc.) varies by type, so refer to the page for each type for more information.

Explanation of Items

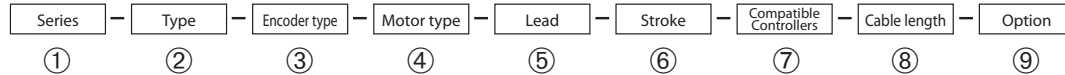

① Series	This indicates the name of each series.
② Type	This indicates the shape (slider, rod, etc.), size (width 22mm, etc.) and motor connection method, etc.
③ Encode type	This indicates whether the encoder installed in the actuator is an "absolute type" or an "incremental" type. * If the controller for the Simple Absolute type is used, use actuator encoder type "I" (incremental specification).
④ Motor type	This shows the wattage of the motor installed in the actuator. Since the RCP3 Series uses a pulse motor, the motor size (20P=20□ motor) is shown instead of the wattage.
⑤ Lead	This shows a feed screw lead (the distance the slider moves per revolution of the feed screw). Ball screws are shown in numerals only. Lead screws have an S after the number.
⑥ Stroke	This indicates the stroke for the actuator (operating range). (Units are in mm)
⑦ Compatible Controllers	This indicates the controller types that can be connected. (The motor-encoder cable changes according to type of controller.)
⑧ Cable length	This indicates the length of the motor-encoder cable connecting the actuator and controller.
⑨ Option	This indicates the options that can be installed on the actuator. * If multiple options are selected, specify them in alphabetical order. (Example:A3-B-ML)

RCP3 — [] — [] — [] — [] — [] — [] — [] — []

Series Type Encoder type Motor type Lead Stroke Compatible Controller Cable length Options

20P	20□ motor
20SP	20□ high-thrust motor
28P	28□ motor

1	Ball screw 1mm
2	Ball screw 2mm
4	Ball screw 4mm
6	Ball screw 6mm
1S	Lead screw 1mm
2S	Lead screw 2mm
4S	Lead screw 4mm
6S	Lead screw 6mm

*Differs depending on type.

20	20mm
S	S
150	150mm

*Range differs according to type.

P1	PCON
	RPCON
P3	PSEL
	PMEC
	PSEP

N	No cable
P	1m
S	3m
M	5m
X□□	Length designation

B	Brake
CJT	Cable exit direction (top)
CJR	Cable exit direction (right)
CJL	Cable exit direction (left)
CJO	Cable exit direction (outside)
CJB	Cable exit direction (bottom)
ML	Left-mounted motor
MR	Right-mounted motor
NM	Reverse-home specification

*Available items differ according to type.

Mini Slider type	SA2AC	Motor unit Coupling type width 22mm	TA3C	Motor unit Coupling type width 36mm
	SA2BC	Motor unit Coupling type width 28mm	TA4C	Motor unit Coupling type width 40mm
	SA2AR	Side-Mounted Motor type width 58mm	TA3R	Side-Mounted Motor type width 72mm
	SA2BR	Side-Mounted Motor type width 59.5mm	TA4R	Side-Mounted Motor type width 81mm
Mini Rod type	RA2AC	Motor unit Coupling type width 22mm		
	RA2BC	Motor unit Coupling type width 28mm		
	RA2AR	Side-Mounted Motor type width 58mm		
	RA2BR	Side-Mounted Motor type width 59.5mm		

Model Descriptions



RCA2 — [] — **I** — [] — [] — [] — [] — [] — []

Series Type Encoder type Motor type Lead Stroke Compatible Controller Cable length Options

Mini Slider type	SA2AC	Motor unit Coupling type width 20mm	5 5W	1 Ball screw 1mm	20 20mm	A1 ACON A3 RACON A3 ASEL A3 AMEC A3 ASEP			
	SA2AR	Side-mounted motor type width 41mm	10 10W 20 20W	2 Ball screw 2mm 4 Ball screw 4mm 6 Ball screw 6mm 1S Lead screw 1mm 2S Lead screw 2mm 4S Lead screw 4mm 6S Lead screw 6mm	50 50mm 75 75mm				*Range differs according to type.
	RA2AC	Motor unit coupling type width 18mm							
	RA2AR	Side-mounted motor type width 41mm							
Mini Rod type	RA3NA	Short Length, Fixed Nut type width 28mm	TCA3NA	Short Length, Compact type width 32mm	N No cable P 1m S 3m M 5m X□□ Length designation				
	RA4NA	Short Length, Fixed Nut type width 34mm	TCA4NA	Short Length, Compact type width 36mm					
	RP3NA	Short Length, Tapped Hole type width 28mm	TWA3NA	Short Length, Wide type width 50mm					
	RP4NA	Short Length, Tapped Hole type width 34mm	TWA4NA	Short Length, Wide type width 58mm					
	GS3NA	Short Length, Single-Guide Free Mount type width 28mm	TFA3NA	Short Length, Flat type width 61mm					
	GS4NA	Short Length, Single-Guide Free Mount type width 34mm	TFA4NA	Short Length, Flat type width 71mm					
	GD3NA	Short Length, Double-Guide Free Mount type width 28mm	TA4C	Motor Unit Coupling type width 40mm					
	GD4NA	Short Length, Double-Guide Free Mount type width 34mm	TA4R	Side-mounted motor type width 81mm					
	SD3NA	Short Length, Double-Guide Slide Unit type width 60mm							
	SD4NA	Short Length, Double-Guide Slide Unit type width 72mm							

*Differs depending on type.

K2	Change direction for connector cable exit
B	Brake
CJT	Cable exit direction (top)
CJR	Cable exit direction (right)
CJL	Cable exit direction (left)
CJO	Cable exit direction (outside)
CJB	Cable exit direction (bottom)
LA	Power-saving specification
ML	Left-mounted motor
MR	Right-mounted motor
MT	Top-mounted motor
NM	Reverse-home specification

* Available items differ according to type.

RCS2 — [] — **I** — **60** — [] — [] — **T2** — [] — []

Series Type Encoder type Motor type Lead Stroke Compatible Controller Cable length Options

Small rod type	RN5N	Short Length, Fixed Nut type width 46 mm	60 60W	2.5 2.5 mm (Ball screw)	50 50mm 75 75mm	T2 SCON-CA T2 SSEL T2 XSEL		
	RP5N	Short Length, Tapped Hole type width 46 mm		5 5 mm (Ball screw)				
	GS5N	Short Length, Single-Guide type width 46 mm		10 10 mm (Ball screw)				
	GD5N	Short Length, Double-Guide type width 46 mm						
	SD5N	Short Length, Double-Guide Slide Unit type width 94 mm						
Small table type	TCA5N	Short Length, Compact type width 48 mm				N No cable P 1m S 3m M 5m X□□ Length designation R□□ Robot cable		
	TWA5N	Short Length, Wide type width 80 mm						
	TFA5N	Short Length, Flat type width 95 mm						

K1	Connector cable exit from the left
K2	Connector cable exit from the front
K3	Connector cable exit from the right

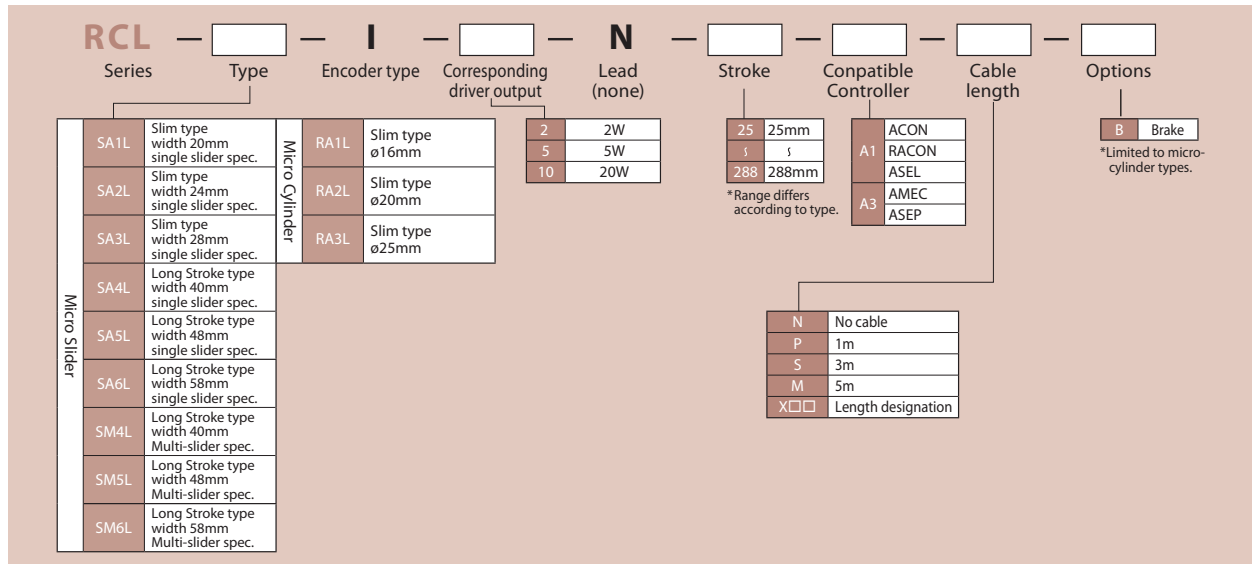

■ Skillful use of the "Lead Screw" type

- (1) Lead screws are suitable for uses with infrequent operations. (As a guide, this would be approximately 5 years, for 1 operation every 10 seconds, 24-hour use, 240 days a year.)
- (2) Lead screws are suitable for uses with small payloads, light loads. (1kg or less)
- (3) Use when repeated positioning accuracy of less than ±0.05mm is needed.
- (4) Please set up in a location where maintenance will be easy.

RCP3-SA2AC

ROBO Cylinder Mini Slider Type Motor Unit Coupling Type Actuator Width 22mm Pulse Motor Lead Screw Specification

Model Description	RCP3	SA2AC	I	20P					
	Series	Type	Encoder type	Motor type	Lead	Stroke	Compatible controllers	Cable length	Option
			I: Incremental specification * Model number is "I" when used with simple absolute unit.	20P: Pulse motor 20□size	45: Lead screw 4mm 25: Lead screw 2mm 15: Lead screw 1mm	25: 25mm ? : 100: 100mm (every 25mm)	P1: PCON RPCON PSEL P3: PMEC PSEP	N: None P: 1 m S: 3 m M: 5 m X□□: Length Designation	NM: Reversed-home specification

* See page 14 for details on the model descriptions.

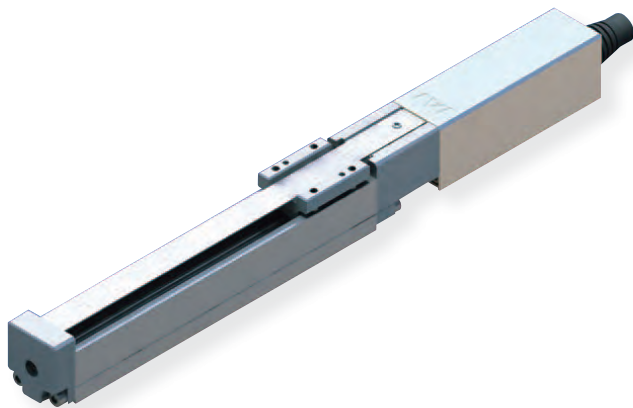

Correlation Diagrams of Speed and Load Capacity
With the RCP3 series, due to the characteristics of the pulse motor, load capacity decreases as the speed increases. Use the chart below to confirm that the desired speed and load capacity requirements are met.

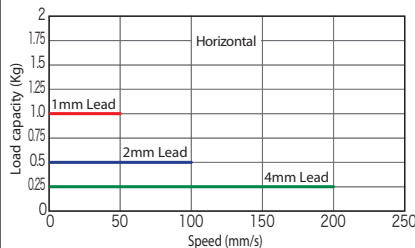

- (1) The payload is the value when operated at 0.2G acceleration. The acceleration upper limit is the value indicated above.
- (2) Cannot be used in the horizontal orientation with the slider facing to the side or in the vertical orientation.
- (3) Service life decreases significantly if used in a dusty environment.

Actuator Specifications Table

Leads and Payloads

Model	Feed screw	Lead (mm)	Maximum payload		Positioning repeatability (mm)	Stroke (mm)
			Horizontal (kg)	Vertical (kg)		
RCP3-SA2AC-I-20P-4S-①-②-③-④	Lead screw	4	0.25	—	±0.05	25 to 100 (every 25mm)
RCP3-SA2AC-I-20P-2S-①-②-③-④		2	0.5	—		
RCP3-SA2AC-I-20P-1S-①-②-③-④		1	1	—		

Legend ① Stroke ② Compatible Controllers ③ Cable length ④ Option

Stroke and Maximum Speed

Lead	Stroke	25 (mm)	50~100 (mm)
		4	180
2		100	
1		50	

(unit: mm/s)

① Stroke list

① Stroke (mm)	Standard price
25	—
50	—
75	—
100	—

③ Cable Length

Type	Cable symbol	Standard price
Standard type (Robot cable)	P (1m)	—
	S (3m)	—
	M (5m)	—
Special length	X06 (6m) ~ X10 (10m)	—
	X11 (11m) ~ X15 (15m)	—
	X16 (16m) ~ X20 (20m)	—

* The standard cable for the RCP3 is the robot cable.

④ Options

Title	Option code	See page	Standard price
Reversed-home specification	NM	—	—

Actuator Specifications

Item	Description
Drive System	Lead screw, ø4mm, rolled C10
Lost motion	0.3mm or less (initial value)
Base	Material: Aluminum, white alumite treated
Guide	Slide guide
Ambient operating temperature, humidity	0 to 40°C, 85% RH or less (Non-condensing)
Service life	10 million cycles

Dimensional Drawings

- *1 Connect the motor and encoder cables.
- *2 During home return, be careful to avoid interference from peripheral objects because the slider travels until the mechanical end.

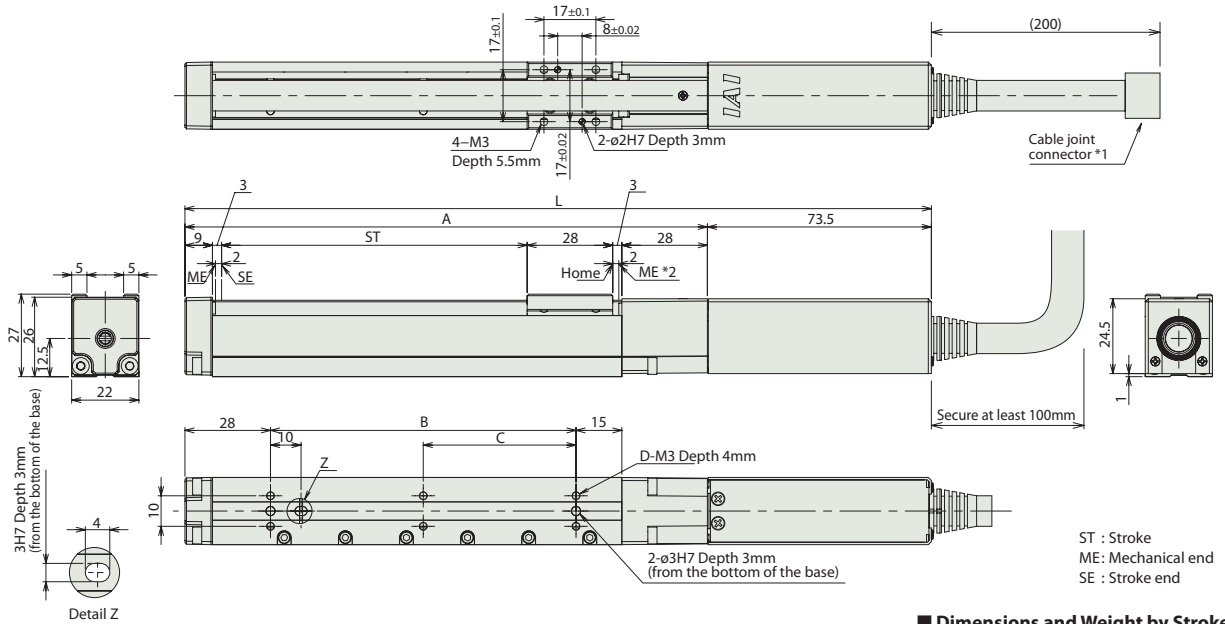

■ Dimensions and Weight by Stroke

Stroke	25	50	75	100
L	169.5	194.5	219.5	244.5
A	96	121	146	171
B	25	50	75	100
C	0	0	0	50
D	4	4	4	6
Mass (kg)	0.25	0.27	0.29	0.3

② Compatible Controllers

RCP3 series actuators can be operated with the controllers indicated below. Select the type according to your intended application.

Title	External View	Model	Features	Maximum number of positioning points	Input power	Power-supply capacity	Standard price	Reference Page
Solenoid valve type		PMEC-C-20PI-NP-2-①	Easy-to-use controller, even for beginners	3 points	AC100V AC200V	See the ROBO Cylinder general catalog.	-	→ P131
Splash-proof solenoid valve type		PSEP-C-20PI-NP-2-0	Operable with the same signal as a solenoid valve. Supports both single and double solenoid types. No homing necessary with the simple absolute type.					
		PSEP-CW-20PI-NP-2-0						
Positioner type		PCON-C-20PI-NP-2-0	Up to 512 positioning points are supported.	512 points	DC24V	Maximum: 2A	-	See the ROBO Cylinder general catalog
Safety-compliant positioner type		PCON-CG-20PI-NP-2-0						
Pulse-train input type (Differential line driver)		PCON-PL-20PI-NP-2-0	Pulse-train input type with differential line driver support	(-)				
Pulse-train input type (Open collector)		PCON-PO-20PI-NP-2-0	Pulse-train input type with open collector support					
Serial communication type		PCON-SE-20PI-N-0-0	Dedicated to serial communication	64 points				
Field network type		RPCON-20P	Dedicated to a field network	768 points				
Program control type		PSEL-C-1-20PI-NP-2-0	Program operation is supported. Up to two axes can be operated.	1500 points				

* This is for the single-axis PSEL
 * ① indicates the power-supply voltage type (1: 100 V/2: 100 to 240 V).

RCP3-SA2BC

ROBO Cylinder Mini Slider Type Motor Unit Coupling Type Actuator Width 28mm Pulse Motor Lead Screw Specification

Model Description	RCP3 — SA2BC — I — 20P — <input type="checkbox"/> — <input type="checkbox"/> — <input type="checkbox"/> — <input type="checkbox"/> — <input type="checkbox"/>							
Series	Type	Encoder type	Motor type	Lead	Stroke	Compatible controllers	Cable length	Option
I: Incremental specification * Model number is "I" when used with simple absolute unit.	20P: Pulse motor 20□ size	65: Lead screw 6mm 45: Lead screw 4mm 25: Lead screw 2mm	25: 25mm ? : 150: 150mm (every 25mm)	P1: PCON RPCON PSEL P3: PMEC PSEP	N: None P: 1 m S: 3 m M: 5 m X□□: Length Designation	NM: Reversed-home specification		

* See page 14 for details on the model descriptions.

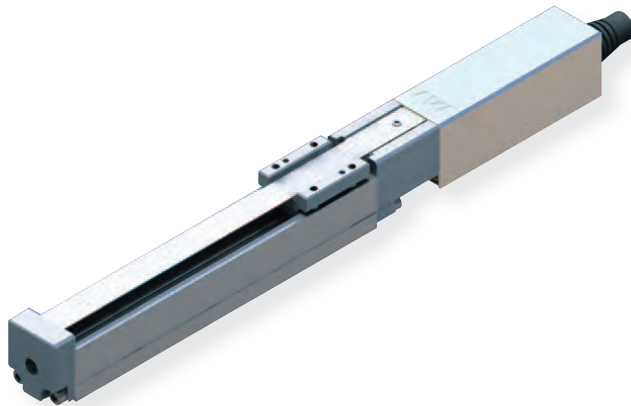

Correlation Diagrams of Speed and Load Capacity
With the RCP3 series, due to the characteristics of the pulse motor, load capacity decreases as the speed increases. Use the chart below to confirm that the desired speed and load capacity requirements are met.

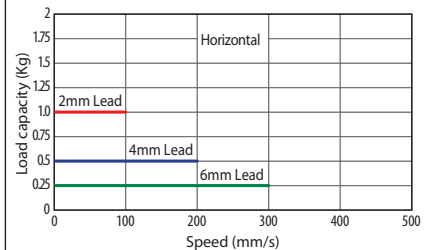

- POINT**
Notes on selection
- (1) The payload is the value when operated at 0.2G acceleration. The acceleration upper limit is the value indicated above.
 - (2) Cannot be used in the horizontal orientation with the slider facing to the side or in the vertical orientation.
 - (3) Service life decreases significantly if used in a dusty environment.

Actuator Specifications Table

Leads and Payloads

Model	Feed screw	Lead (mm)	Maximum payload		Positioning repeatability (mm)	Stroke (mm)
			Horizontal (kg)	Vertical (kg)		
RCP3-SA2BC-I-20P-6S-①-②-③-④	Lead screw	6	0.25	—	±0.05	25 to 150 (every 25mm)
RCP3-SA2BC-I-20P-4S-①-②-③-④		4	0.5	—		
RCP3-SA2BC-I-20P-2S-①-②-③-④		2	1	—		

Legend ① Stroke ② Compatible Controllers ③ Cable length ④ Option

Stroke and Maximum Speed

Lead	Stroke	25 (mm)	50~100 (mm)	75~150 (mm)
		6	180	280
4	180	200		
2		100		

(unit: mm/s)

① Stroke list

① Stroke (mm)	Standard price
25	—
50	—
75	—
100	—
125	—
150	—

③ Cable Length

Type	Cable symbol	Standard price
Standard type (Robot cable)	P (1m)	—
	S (3m)	—
	M (5m)	—
Special length	X06 (6m) ~ X10 (10m)	—
	X11 (11m) ~ X15 (15m)	—
	X16 (16m) ~ X20 (20m)	—

* The standard cable for the RCP3 is the robot cable.

④ Options

Title	Option code	See page	Standard price
Reversed-home specification	NM	—	—

Actuator Specifications

Item	Description
Drive System	Lead screw, ø6mm, rolled C10
Lost motion	0.3mm or less (initial value)
Base	Material: Aluminum, white alumite treated
Guide	Slide guide
Ambient operating temperature, humidity	0 to 40°C, 85% RH or less (Non-condensing)
Service life	10 million cycles

RCP3-SA2AR

ROBO Cylinder Mini Slider Type Side-Mounted Motor Type Actuator Width 58mm Pulse Motor Lead Screw Specification

Model Description	RCP3 — SA2AR — I — 20P	<input type="checkbox"/>	<input type="checkbox"/>	<input type="checkbox"/>	<input type="checkbox"/>	<input type="checkbox"/>		
Series	Type	Encoder type	Motor type	Lead	Stroke	Compatible controllers	Cable length	Option
		I: Incremental specification * Model number is "I" when used with simple absolute unit.	20P: Pulse motor 20□ size	45: Lead screw 4mm 25: Lead screw 2mm 15: Lead screw 1mm	25: 25mm ? : 100: 100mm (every 25mm)	P1: PCON RCON PSEL P3: PMEC PSEP	N: None P: 1 m S: 3 m M: 5 m X□□: Length Designation	See options table below. * Be sure to specify which side the motor is to be mounted (ML/MR)

* See page 14 for details on the model descriptions.

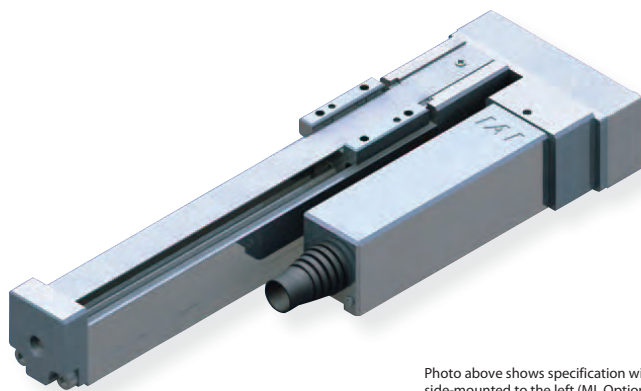
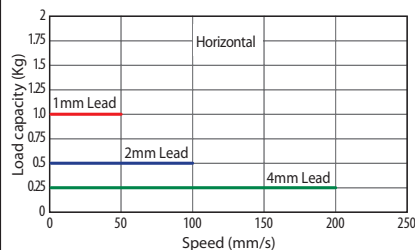

Photo above shows specification with motor side-mounted to the left (ML Option).

Correlation Diagrams of Speed and Load Capacity

With the RCP3 series, due to the characteristics of the pulse motor, load capacity decreases as the speed increases. Use the chart below to confirm that the desired speed and load capacity requirements are met.



- POINT**
Notes on selection
- (1) The payload is the value when operated at 0.2G acceleration. The acceleration upper limit is the value indicated above.
 - (2) Cannot be used in the horizontal orientation with the slider facing to the side or in the vertical orientation.
 - (3) Service life decreases significantly if used in a dusty environment.

Actuator Specifications Table

Leads and Payloads

Model	Feed screw	Lead (mm)	Maximum payload		Positioning repeatability (mm)	Stroke (mm)
			Horizontal (kg)	Vertical (kg)		
RCP3-SA2AR-I-20P-4S-①-②-③-④	Lead screw	4	0.25	—	±0.05	25 to 100 (every 25mm)
RCP3-SA2AR-I-20P-2S-①-②-③-④		2	0.5	—		
RCP3-SA2AR-I-20P-1S-①-②-③-④		1	1	—		

Legend ① Stroke ② Compatible Controllers ③ Cable length ④ Option

Stroke and Maximum Speed

Lead	Stroke	25 (mm)	50~100 (mm)
		4	180
2		100	
1		50	

(unit: mm/s)

① Stroke list

① Stroke (mm)	Standard price
25	—
50	—
75	—
100	—

③ Cable Length

Type	Cable symbol	Standard price
Standard type (Robot cable)	P (1m)	—
	S (3m)	—
	M (5m)	—
Special length	X06 (6m) ~ X10 (10m)	—
	X11 (11m) ~ X15 (15m)	—
	X16 (16m) ~ X20 (20m)	—
		—

* The standard cable for the RCP3 is the robot cable.

④ Options

Title	Option code	See page	Standard price
Specification with motor side-mounted to the left	ML	—	—
Specification with motor side-mounted to the right	MR	—	—
Reversed-home specification	NM	—	—

Actuator Specifications

Item	Description
Drive System	Lead screw, ø4mm, rolled C10
Lost motion	0.3mm or less (initial value)
Base	Material: Aluminum, white alumite treated
Guide	Slide guide
Ambient operating temperature, humidity	0 to 40°C, 85% RH or less (Non-condensing)
Service life	10 million cycles

Dimensional Drawings

- *1 Connect the motor and encoder cables.
- *2 During home return, be careful to avoid interference from peripheral objects because the slider travels until the mechanical end.
- * The drawing below shows the specification of the motor side-mounted to the left.

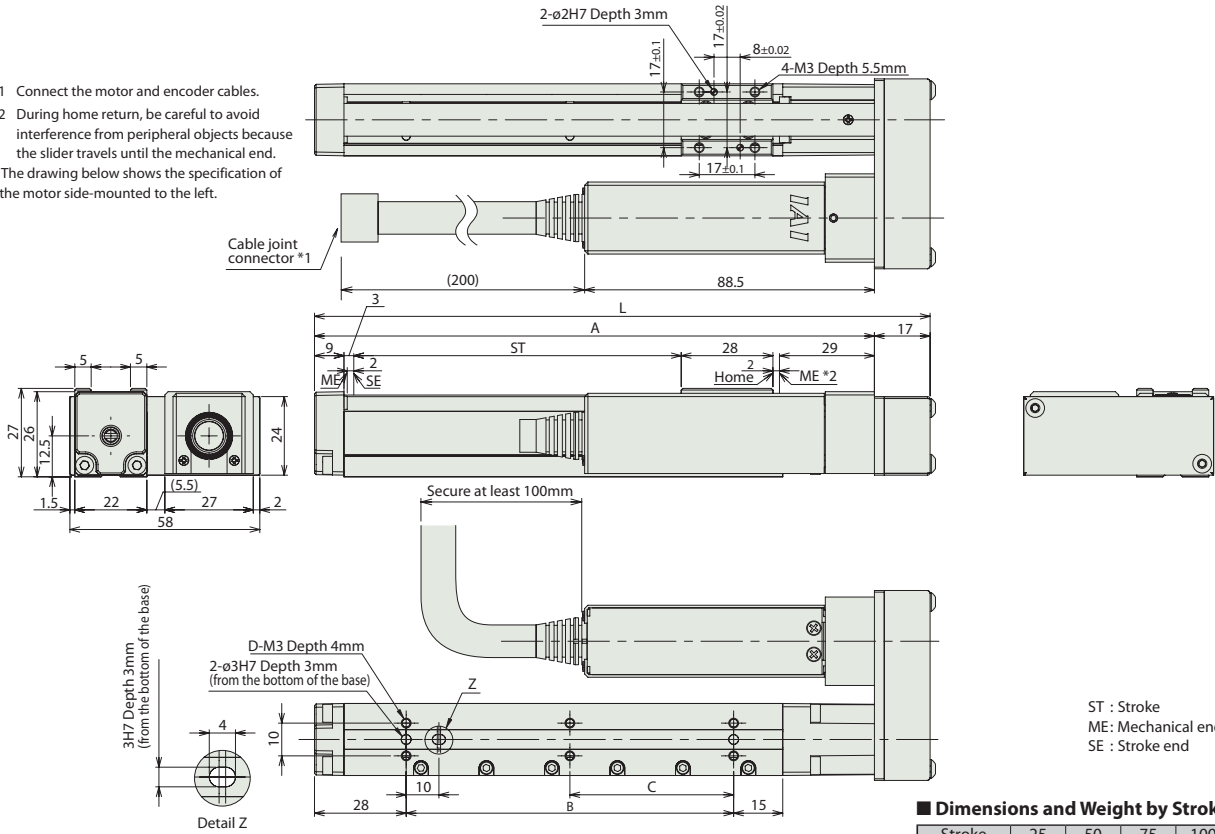

ST : Stroke
ME : Mechanical end
SE : Stroke end

■ Dimensions and Weight by Stroke

Stroke	25	50	75	100
L	113	138	163	188
A	96	121	146	171
B	25	50	75	100
C	0	0	0	50
D	4	4	4	6
Mass (kg)	0.28	0.3	0.32	0.33

② Compatible Controllers

RCP3 series actuators can be operated with the controllers indicated below. Select the type according to your intended application.

Title	External View	Model	Features	Maximum number of positioning points	Input power	Power-supply capacity	Standard price	Reference Page
Solenoid valve type		PMEC-C-20PI-NP-2-0 ①	Easy-to-use controller, even for beginners	3 points	AC100V AC200V	See the ROBO Cylinder general catalog.	-	→ P131
		PSEP-C-20PI-NP-2-0	Operable with the same signal as a solenoid valve. Supports both single and double solenoid types. No homing necessary with the simple absolute type.					
Splash-proof solenoid valve type		PSEP-CW-20PI-NP-2-0						→ P141
Positioner type		PCON-C-20PI-NP-2-0	Up to 512 positioning points are supported.	512 points	DC24V	Maximum: 2A	-	See the ROBO Cylinder general catalog
Safety-compliant positioner type		PCON-CG-20PI-NP-2-0						
Pulse-train input type (Differential line driver)		PCON-PL-20PI-NP-2-0	Pulse-train input type with differential line driver support	(-)	DC24V	Maximum: 2A	-	See the ROBO Cylinder general catalog
Pulse-train input type (Open collector)		PCON-PO-20PI-NP-2-0	Pulse-train input type with open collector support					
Serial communication type		PCON-SE-20PI-N-0-0	Dedicated to serial communication	64 points				
Field network type		RPCON-20P	Dedicated to a field network	768 points				
Program control type		PSEL-C-1-20PI-NP-2-0	Program operation is supported. Up to two axes can be operated.	1500 points				

* This is for the single-axis PSEL

* ① indicates the power-supply voltage type (1: 100 V/2: 100 to 240 V).

RCP3-SA2BR

ROBO Cylinder Mini Slider Type Side-Mounted Motor Type Actuator Width 59.5mm Pulse Motor Lead Screw Specification

Model Description	RCP3	SA2BR	I	20P					
	Series	Type	Encoder type	Motor type	Lead	Stroke	Compatible controllers	Cable length	Option
			I: Incremental specification * Model number is "I" when used with simple absolute unit.	20P: Pulse motor 20□size	65: Lead screw 6mm 45: Lead screw 4mm 25: Lead screw 2mm	25: 25mm ? : 150: 150mm (every 25mm)	P1: PCON RPCON PSEL P3: PMEC PSEP	N: None P: 1 m S: 3 m M: 5 m X□□: Length Designation	See options table below. * Be sure to specify which side the motor is to be mounted (ML/MR).

* See page 14 for details on the model descriptions.

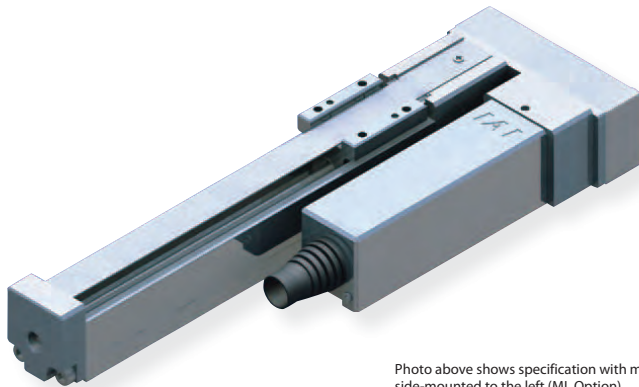
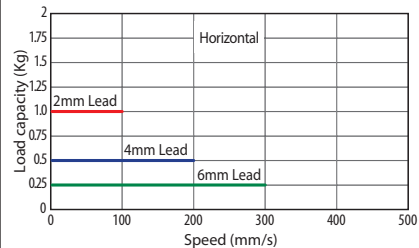

Photo above shows specification with motor side-mounted to the left (ML Option).

Correlation Diagrams of Speed and Load Capacity
With the RCP3 series, due to the characteristics of the pulse motor, load capacity decreases as the speed increases. Use the chart below to confirm that the desired speed and load capacity requirements are met.



- POINT**
Notes on selection
- (1) The payload is the value when operated at 0.2G acceleration. The acceleration upper limit is the value indicated above.
 - (2) Cannot be used in the horizontal orientation with the slider facing to the side or in the vertical orientation.
 - (3) Service life decreases significantly if used in a dusty environment.

Actuator Specifications Table

Leads and Payloads

Model	Feed screw	Lead (mm)	Maximum payload		Positioning repeatability (mm)	Stroke (mm)
			Horizontal (kg)	Vertical (kg)		
RCP3-SA2BR-I-20P-6S-①-②-③-④	Lead screw	6	0.25	—	±0.05	25 to 150 (every 25mm)
RCP3-SA2BR-I-20P-4S-①-②-③-④		4	0.5	—		
RCP3-SA2BR-I-20P-2S-①-②-③-④		2	1	—		

Legend ① Stroke ② Compatible Controllers ③ Cable length ④ Option

Stroke and Maximum Speed

Lead	Stroke	25 (mm)	50 (mm)	75~150 (mm)
		6	180	280
4	4	180		200
		100		
2	100			

(unit: mm/s)

① Stroke list

① Stroke (mm)	Standard price
25	—
50	—
75	—
100	—
125	—
150	—

③ Cable Length

Type	Cable symbol	Standard price
Standard type (Robot cable)	P (1m)	—
	S (3m)	—
	M (5m)	—
Special length	X06 (6m) ~ X10 (10m)	—
	X11 (11m) ~ X15 (15m)	—
	X16 (16m) ~ X20 (20m)	—

* The standard cable for the RCP3 is the robot cable.

③ Options

Title	Option code	See page	Standard price
Specification with motor side-mounted to the left	ML	—	—
Specification with motor side-mounted to the right	MR	—	—
Reversed-home specification	NM	—	—

Actuator Specifications

Item	Description
Drive System	Lead screw, ø6mm, rolled C10
Lost motion	0.3mm or less (initial value)
Base	Material: Aluminum, white alumite treated
Guide	Slide guide
Ambient operating temperature, humidity	0 to 40°C, 85% RH or less (Non-condensing)
Service life	10 million cycles

Dimensional Drawings

- *1 Connect the motor and encoder cables.
- *2 During home return, be careful to avoid interference from peripheral objects because the slider travels until the mechanical end.

* The drawing below shows the specification of the motor side-mounted to the left.

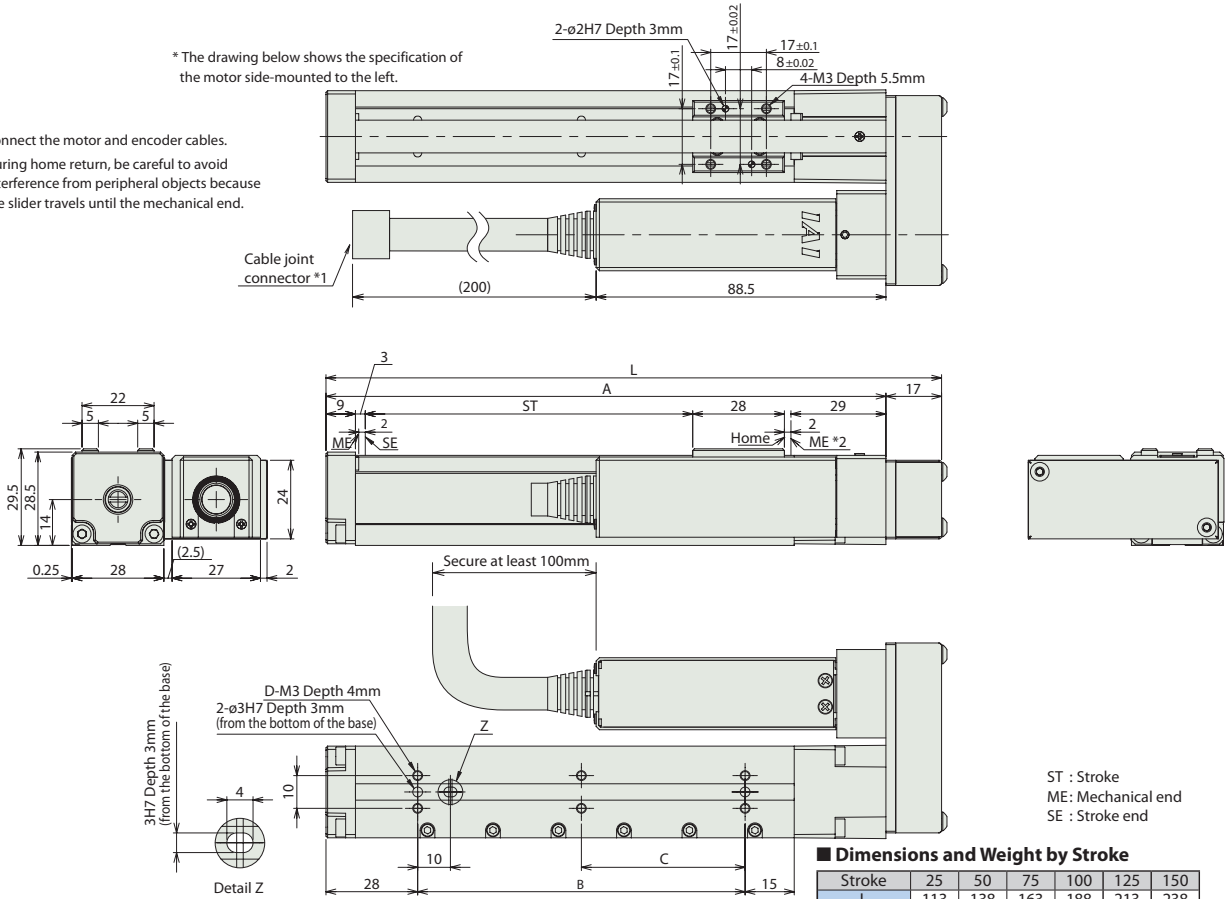

ST : Stroke
ME : Mechanical end
SE : Stroke end

■ Dimensions and Weight by Stroke

Stroke	25	50	75	100	125	150
L	113	138	163	188	213	238
A	96	121	146	171	196	221
B	25	50	75	100	125	150
C	0	0	0	50	62.5	75
D	4	4	4	6	6	6
Mass (kg)	0.32	0.34	0.37	0.39	0.42	0.46

② Compatible Controllers

RCP3 series actuators can be operated with the controllers indicated below. Select the type according to your intended application.

Title	External View	Model	Features	Maximum number of positioning points	Input power	Power-supply capacity	Standard price	Reference Page
Solenoid valve type		PMEC-C-20PI-NP-2-①	Easy-to-use controller, even for beginners	3 points	AC100V AC200V	See the ROBO Cylinder general catalog.	-	→ P131
	Splash-proof solenoid valve type		PSEP-C-20PI-NP-2-0					Operable with the same signal as a solenoid valve. Supports both single and double solenoid types. No homing necessary with the simple absolute type.
Positioner type			PCON-C-20PI-NP-2-0	Up to 512 positioning points are supported.	512 points	DC24V	Maximum: 2A	-
	PCON-CG-20PI-NP-2-0							
Pulse-train input type (Differential line driver)		PCON-PL-20PI-NP-2-0	Pulse-train input type with differential line driver support	(-)	DC24V	Maximum: 2A	-	See the ROBO Cylinder general catalog
Pulse-train input type (Open collector)		PCON-PO-20PI-NP-2-0	Pulse-train input type with open collector support					
Serial communication type		PCON-SE-20PI-N-0-0	Dedicated to serial communication	64 points	DC24V	Maximum: 2A	-	See the ROBO Cylinder general catalog
Field network type		RPCON-20P	Dedicated to a field network	768 points	DC24V	Maximum: 2A	-	See the ROBO Cylinder general catalog
Program control type		PSEL-C-1-20PI-NP-2-0	Program operation is supported. Up to two axes can be operated.	1500 points	DC24V	Maximum: 2A	-	See the ROBO Cylinder general catalog

* This is for the single-axis PSEL

* ① indicates the power-supply voltage type (1: 100 V/2: 100 to 240 V).

RCA2-SA2AC

ROBO Cylinder Mini Slider Type Motor Unit Coupling Type Actuator Width 20mm 24V Servo Motor Ball Screw Specification

Model Description	RCA2 — SA2AC — I — 5 — <input type="text"/> — <input type="text"/> — A3 — <input type="text"/> — <input type="text"/>							
Series	Type	Encoder type	Motor type	Lead	Stroke	Compatible controllers	Cable length	Option
		I: Incremental specification * Model number is "I" when used with simple absolute unit.	5: Servo motor 5W	4: 4mm 2: 2mm 1: 1mm	25: 25mm ? 100: 100mm (every 25mm)	A3: ASEP	N: None P: 1 m S: 3 m M: 5 m X <input type="text"/> : Length Designation	See options table below.

* See page 14 for details on the model descriptions.

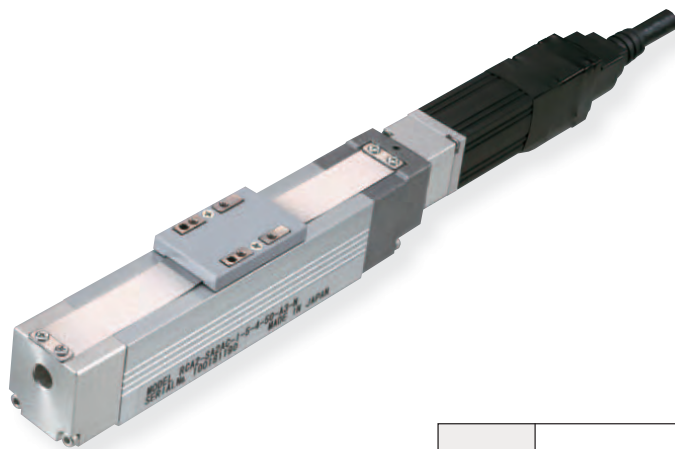

POINT
Notes on selection

- The payload is the value when operated at 0.2G acceleration. The acceleration upper limit is the value indicated above.
- Take note that, since there is no brake, the slider may come down when the power is turned off if the actuator is used vertically.

Actuator Specifications Table

Leads and Payloads

Model	Motor output (W)	Feed screw	Lead (mm)	Maximum payload		Rated thrust (N)	Positioning repeatability (mm)	Stroke (mm)
				Horizontal (kg)	Vertical (kg)			
RCA2-SA2AC-I-5-4-①-A3-②-③	5	Ball screw	4	0.5	0.25	21.4	±0.02	25 to 100 (every 25mm)
RCA2-SA2AC-I-5-2-①-A3-②-③			2	1	0.5	42.3		
RCA2-SA2AC-I-5-1-①-A3-②-③			1	2	1	85.5		

Legend ① Stroke ② Cable length ③ Option

Stroke and Maximum Speed

Lead	Stroke	25 (mm)	50~100 (mm)
		Ball screw	4
	2	100	
	1	50	

(unit: mm/s)

① Stroke list

① Stroke (mm)	Standard price
25	—
50	—
75	—
100	—

② Cable Length

Type	Cable symbol	Standard price
Standard type (Robot cable)	P (1m)	—
	S (3m)	—
	M (5m)	—
Special length	X06 (6m) ~ X10 (10m)	—
	X11 (11m) ~ X15 (15m)	—
	X16 (16m) ~ X20 (20m)	—
		—

* The standard cable for the RCA2 is the robot cable.

③ Options

Title	Option code	See page	Standard price
Reversed-home specification	NM	—	—

Actuator Specifications

Item	Description
Drive System	Ball screw, ø4mm, rolled C10
Lost motion	0.1mm or less
Base	Material: Aluminum, white alumite treated
Guide	Linear guide
Dynamic allowable moment	Ma:0.22N·m, Mb:0.31N·m, Mc:0.28N·m
Allowable overhang	40mm or less in Ma, Mb and Mc directions
Ambient operating temperature, humidity	0 to 40°C, 85% RH or less (Non-condensing)
Service life	5,000km

25 RCA2-SA2AC

Dimensional Drawings

- *1 Connect the motor and encoder cables.
- *2 During home return, be careful to avoid interference from peripheral objects because the slider travels until the mechanical end.

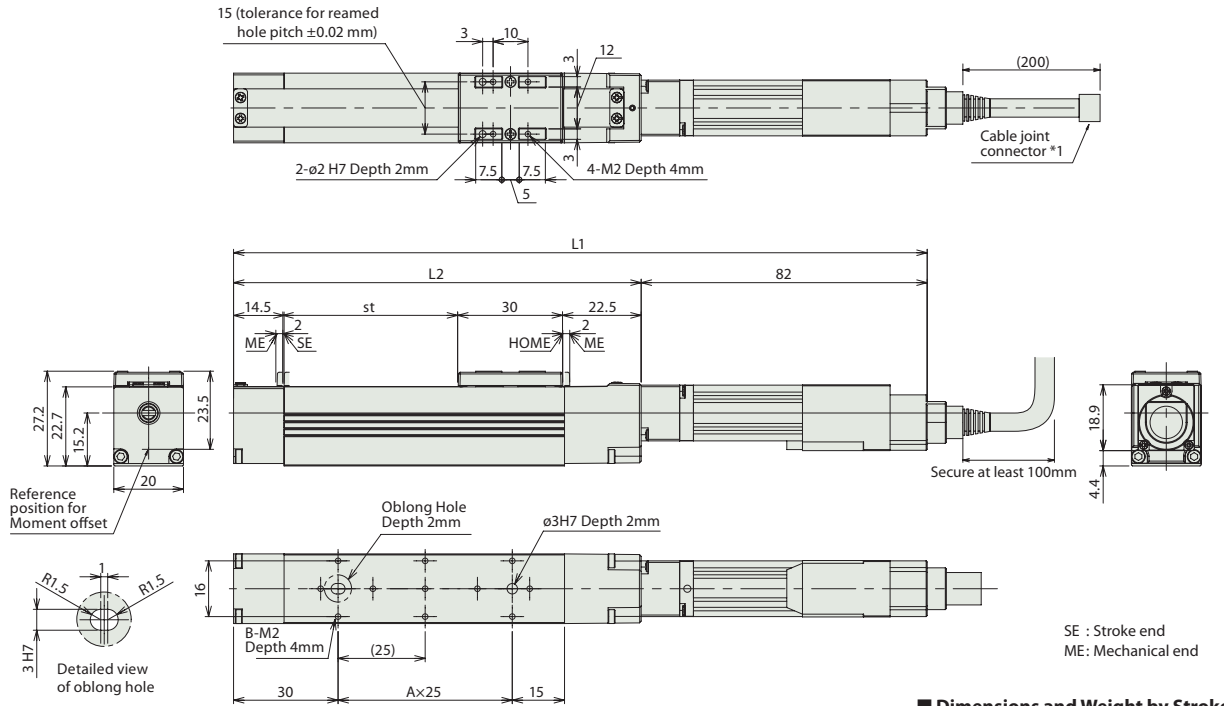

■ Dimensions and Weight by Stroke

Stroke	25	50	75	100
L1	174	199	224	249
L2	92	117	142	167
A	1	2	3	4
B	4	6	8	10
Mass (kg)	0.2	0.22	0.23	0.25

🔗 Compatible Controllers

RCA2 series actuators can be operated with the controllers indicated below. Select the type according to your intended application.

Title	External View	Model	Features	Maximum number of positioning points	Input power	Power-supply capacity	Standard price	Reference Page
Solenoid valve type		ASEP-C-5SI-NP-2-0	Operable with the same signal as a solenoid valve. Supports both single and double solenoid valve types.	3 points	DC24V	(Standard specification) Rated: 1.5 A Maximum: 2.5 A	-	→ P141
Splash-proof solenoid valve type		ASEP-CW-5SI-NP-2-0					-	

Mini Slider type
 Mini Rod type
 Mini Table type
 Mini Servo type
 Controller
 Compact
 Wide
 Flat
 Coupling
 Side-mounted

RCA2-SA2AR

ROBO Cylinder Mini Slider Type Side-Mounted Motor Type Actuator Width 41mm 24V Servo Motor Ball Screw Specification

Model Description	RCA2 — SA2AR — I — 5 — <input type="text"/> — <input type="text"/> — A3 — <input type="text"/> — <input type="text"/>							
Series	Type	Encoder type	Motor type	Lead	Stroke	Compatible controllers	Cable length	Option
		I: Incremental specification * Model number is "I" when used with simple absolute unit.	5: Servo motor 5W	4: 4mm 2: 2mm 1: 1mm	25: 25mm ? 100: 100mm (every 25mm)	A3: ASEP	N: None P: 1 m S: 3 m M: 5 m X <input type="text"/> : Length Designation	See options table below. * Be sure to specify which side the motor is to be mounted (ML/MR).

* See page 14 for details on the model descriptions.

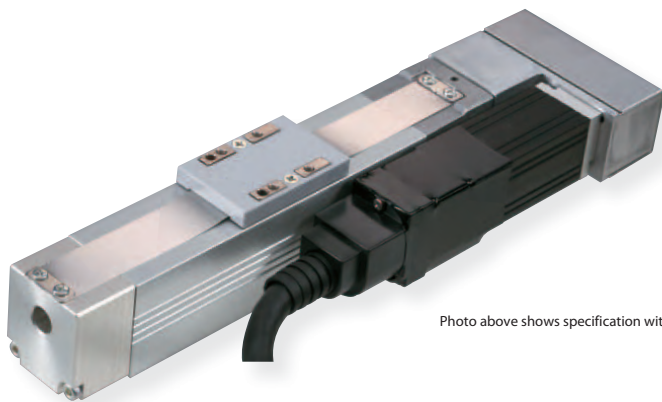

Photo above shows specification with motor side-mounted to the left (ML Option).

POINT
Notes on selection

(1) The payload is the value when operated at 0.2G acceleration. The acceleration upper limit is the value indicated above.

(2) Take note that, since there is no brake, the slider may come down when the power is turned off if the actuator is used vertically.

Actuator Specifications Table

Leads and Payloads

Model	Motor output (W)	Feed screw	Lead (mm)	Maximum payload		Rated thrust (N)	Positioning repeatability (mm)	Stroke (mm)
				Horizontal (kg)	Vertical (kg)			
RCA2-SA2AR-I-5-4-①-A3-②-③	5	Ball screw	4	0.5	0.25	21.4	±0.02	25 to 100 (every 25mm)
RCA2-SA2AR-I-5-2-①-A3-②-③			2	1	0.5	42.3		
RCA2-SA2AR-I-5-1-①-A3-②-③			1	2	1	85.5		

Legend ① Stroke ② Cable length ③ Option

Stroke and Maximum Speed

Lead	Stroke	25 (mm)	50~100 (mm)
		Ball screw	4
	2	100	
	1	50	

(unit: mm/s)

① Stroke list

① Stroke (mm)	Standard price
25	—
50	—
75	—
100	—

② Cable Length

Type	Cable symbol	Standard price
Standard type (Robot cable)	P (1m)	—
	S (3m)	—
	M (5m)	—
Special length	X06 (6m) ~ X10 (10m)	—
	X11 (11m) ~ X15 (15m)	—
	X16 (16m) ~ X20 (20m)	—
		—

* The standard cable for the RCA2 is the robot cable.

③ Options

Title	Option code	See page	Standard price
Reversed-home specification	NM	—	—
Motor side mounted to the right	MR	—	—
Motor side mounted to the left	ML	—	—

Actuator Specifications

Item	Description
Drive System	Ball screw, ø4mm, rolled C10
Lost motion	0.1mm or less
Base	Material: Aluminum, white alumite treated
Guide	Linear guide
Dynamic allowable moment	Ma:0.22N·m, Mb:0.31N·m, Mc:0.28N·m
Allowable overhang	40mm or less in Ma, Mb and Mc directions
Ambient operating temperature, humidity	0 to 40°C, 85% RH or less (Non-condensing)
Service life	5,000km

Dimensional Drawings

- *1 Connect the motor and encoder cables.
- *2 During home return, be careful to avoid interference from peripheral objects because the slider travels until the mechanical end.
- *The drawing below shows the specification of the motor side-mounted to the left.

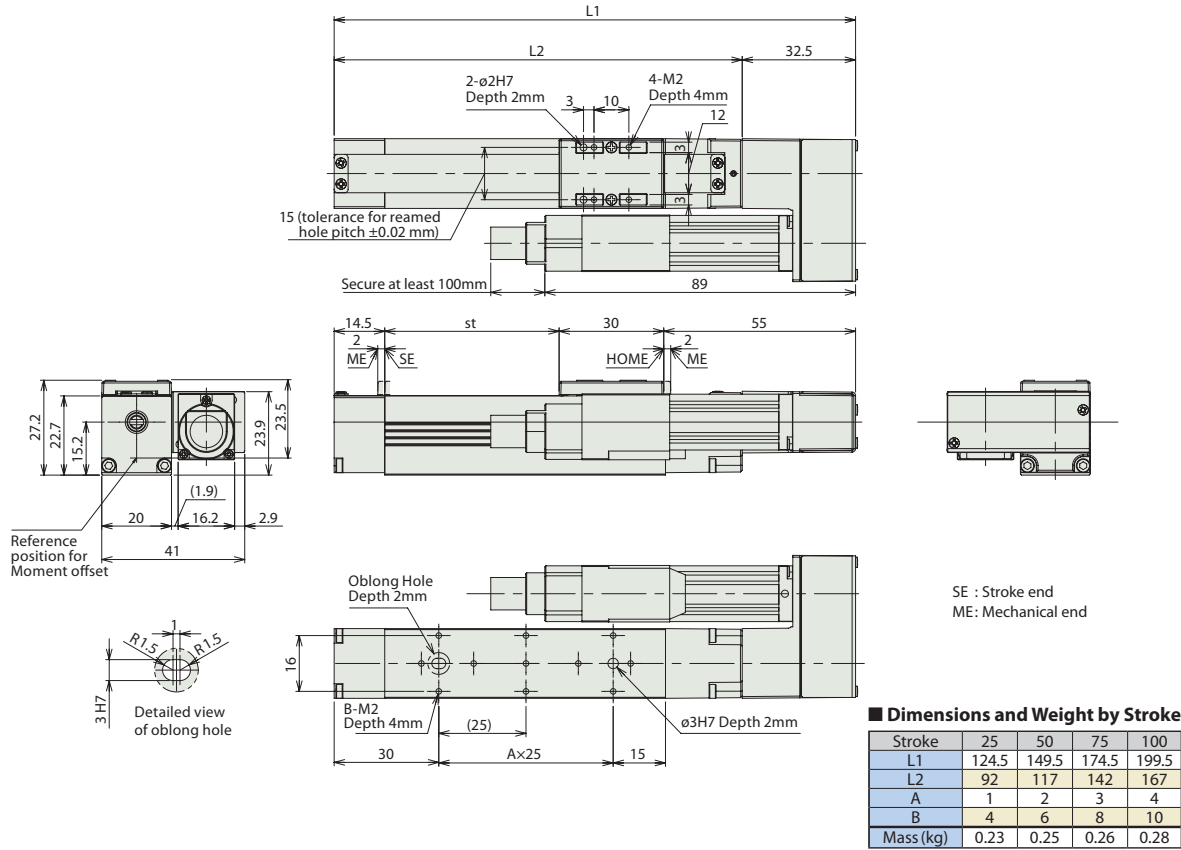

Compatible Controllers

RCA2 series actuators can be operated with the controllers indicated below. Select the type according to your intended application.

Title	External View	Model	Features	Maximum number of positioning points	Input power	Power-supply capacity	Standard price	Reference Page
Solenoid valve type		ASEP-C-5SI-NP-2-0	Operable with the same signal as a solenoid valve. Supports both single and double solenoid valve types.	3 points	DC24V	(Standard specification) Rated: 1.5 A Maximum: 2.5 A	-	→ P141
Splash-proof solenoid valve type		ASEP-CW-5SI-NP-2-0						

- Mini Slider type
- Mini Rod type
- Mini Table type
- Mini Servo type
- Controller
- Compact
- Wide
- Flat
- Coupling
- Side-mounted

RCP3-RA2AC

ROBO Cylinder Mini Rod type Motor Unit Coupling type Actuator Width 22mm Pulse Motor
Ball Screw Specification /Lead Screw Specification

Model Description	RCP3	RA2AC	I						
	Series	Type	Encoder type	Motor type	Lead	Stroke	Compatible controllers	Cable length	Option
			I: Incremental specification * Model number is "I" when used with simple absolute unit.	20P: Pulse Motor 20□ size Standard type 20SP: Pulse Motor 20□ size High-thrust type	4: Ball screw 4mm 2: Ball screw 2mm 1: Ball screw 1mm 45: Lead screw 4mm 25: Lead screw 2mm 15: Lead screw 1mm	25: 25mm ? 100: 100mm (every 25mm)	P1: PCON RPCON PSEL P3: PMEC PSEP	N: None P: 1m S: 3m M: 5m X□□: Length Designation	B: Brake NM: Reversed-home specification

* See page 14 for details on the model descriptions.

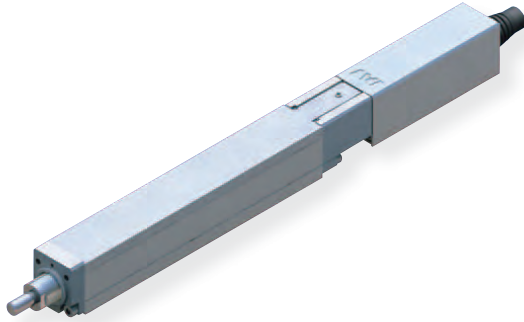

- POINT**
Notes on selection
- (1) The payload is the value when the actuator is operated at an acceleration of 0.3 G (0.2 G for the lead screw specification, if used vertically). The acceleration limit is the value indicated above.
 - (2) The horizontal payload is the value when used in combination with an external guide. Please note that if an external force is applied to the rod in a direction other than the proper direction the rod travels, the detent may get damaged.
 - (3) The maximum pushing force is the value when the actuator is operated at a speed of 5 mm/s.
 - (4) Service life decreases significantly if used in a dusty environment.

Correlation Diagrams of Speed and Load Capacity

With the RCP3 series, due to the characteristics of the pulse motor, load capacity decreases as the speed increases. Use the chart below to confirm that the desired speed and load capacity requirements are met.

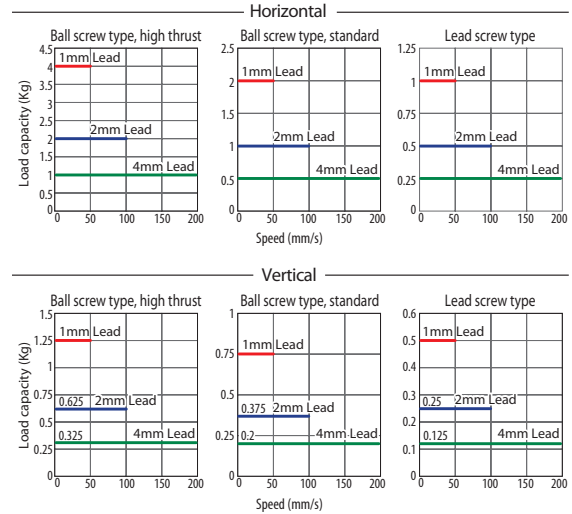

Actuator Specifications Table

Leads and Payloads

Model	Motor type	Feed screw	Lead (mm)	Maximum payload		Maximum pushing force (N)	Positioning repeatability (mm)	Stroke (mm)
				Horizontal (kg)	Vertical (kg)			
RCP3-RA2AC-I-20SP-4-①-②-③-④	High thrust	Ball screw	4	1	0.325	See page 126.	±0.02	25 to 100 (every 25mm)
RCP3-RA2AC-I-20SP-2-①-②-③-④			2	2	0.625			
RCP3-RA2AC-I-20SP-1-①-②-③-④			1	4	1.25			
RCP3-RA2AC-I-20P-4-①-②-③-④			Standard	4	0.5			
RCP3-RA2AC-I-20P-2-①-②-③-④	2	1		0.375				
RCP3-RA2AC-I-20P-1-①-②-③-④	1	2		0.75				
RCP3-RA2AC-I-20P-4S-①-②-③-④	Standard	4		0.25	0.125			
RCP3-RA2AC-I-20P-2S-①-②-③-④		2	0.5	0.25				
RCP3-RA2AC-I-20P-1S-①-②-③-④		1	1	0.5				

Legend ① Stroke ② Compatible controllers ③ Cable length ④ Option

Stroke and Maximum Speed

Lead	Stroke	Maximum Speed	
		25 (mm)	50~100 (mm)
Ball screw	4	180	200
	2	100	
	1	50	
Lead screw	4	180	200
	2	100	
	1	50	

(unit: mm/s)

① Stroke list

① Stroke (mm)	Standard price		
	Feed screw		
	Ball screw		Lead screw
High thrust type	Standard type		
25	—	—	—
50	—	—	—
75	—	—	—
100	—	—	—

④ Options

Title	Option code	See page	Standard price
Brake	B	—	—
Reversed-home specification	NM	—	—

③ Cable Length

Type	Cable symbol	Standard price
Standard type (Robot cable)	P (1m)	—
	S (3m)	—
	M (5m)	—
Special length	X06 (6m) ~ X10 (10m)	—
	X11 (11m) ~ X15 (15m)	—
	X16 (16m) ~ X20 (20m)	—
	—	—

* The standard cable for the RCP3 is the robot cable.

Actuator Specifications

Item	Description
Drive System	Ball screw/Lead screw, ø4mm, rolled C10
Lost motion	Ball screw: 0.1mm or less/Lead screw: 0.3mm or less (default value)
Base	Material: Aluminum, white alumite treated
Guide	Slide guide
Ambient operating temperature, humidity	0 to 40°C, 85% RH or less (Non-condensing)
Service life	Lead screw specification
	Horizontal: 10 million cycles Vertical: 5 million cycles

Dimensional Drawings

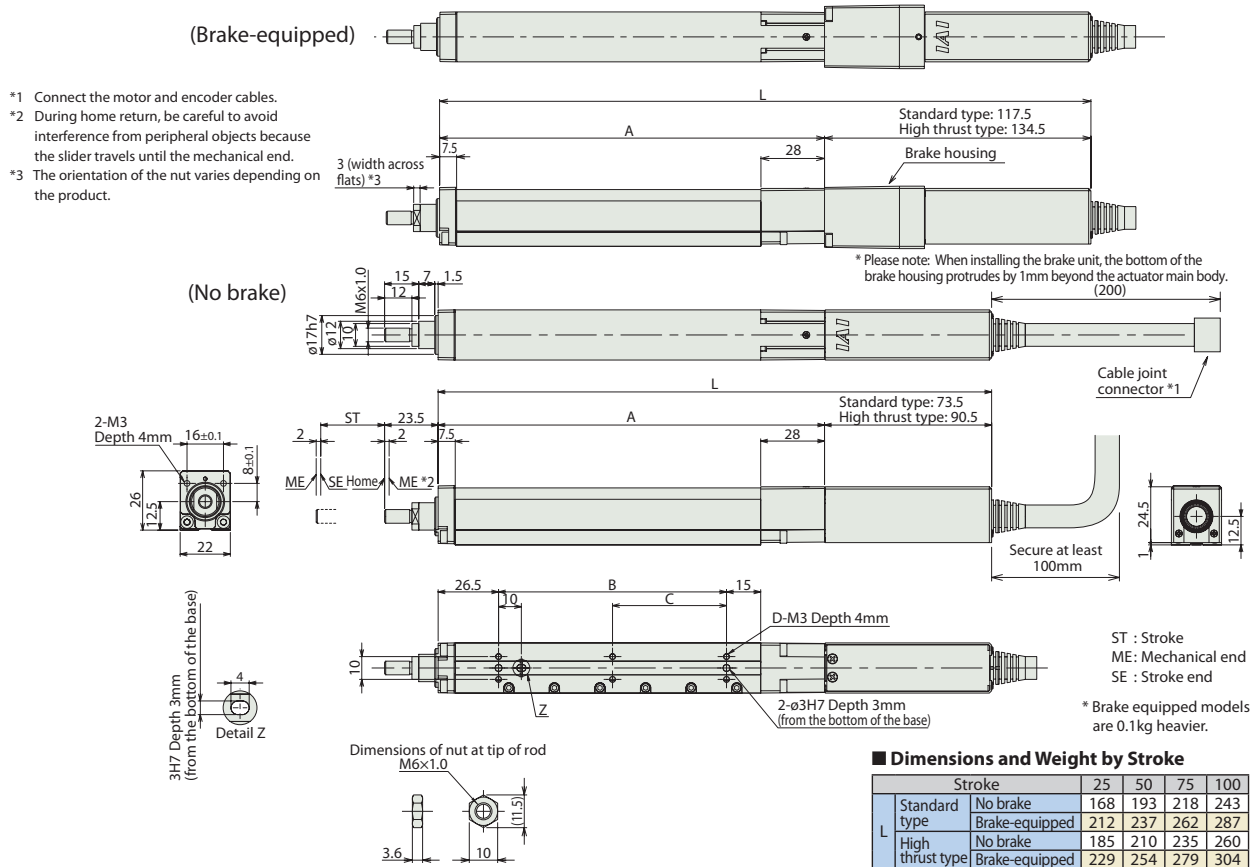

- *1 Connect the motor and encoder cables.
- *2 During home return, be careful to avoid interference from peripheral objects because the slider travels until the mechanical end.
- *3 The orientation of the nut varies depending on the product.

ST : Stroke
 ME : Mechanical end
 SE : Stroke end
 * Brake equipped models are 0.1kg heavier.

② Compatible Controllers

RCP3 series actuators can be operated with the controllers indicated below. Select the type according to your intended application.

Title	External View	Model	Features	Maximum number of positioning points	Input power	Power-supply capacity	Standard price	Reference Page
Solenoid valve type		PMEC-C-20SPI-NP-2-① PMEC-C-20PI-NP-2-①	Easy-to-use controller, even for beginners	3 points	AC100V AC200V	See the ROBO Cylinder general catalog.	-	→ P131
		PSEP-C-20SPI-NP-2-0 PSEP-C-20PI-NP-2-0	Operable with the same signal as a solenoid valve. Supports both single and double solenoid types. No homing necessary with the simple absolute type.					
Splash-proof solenoid valve type		PSEP-CW-20SPI-NP-2-0 PSEP-CW-20PI-NP-2-0	Operable with the same signal as a solenoid valve. Supports both single and double solenoid types. No homing necessary with the simple absolute type.					→ P141
Positioner type		PCON-C-20SPI-NP-2-0 PCON-C-20PI-NP-2-0	Up to 512 positioning points are supported.	512 points	DC24V	Maximum: 2A	-	See the ROBO Cylinder general catalog
Safety-compliant positioner type		PCON-CG-20SPI-NP-2-0 PCON-CG-20PI-NP-2-0						
Pulse-train input type (Differential line driver)		PCON-PL-20SPI-NP-2-0 PCON-PL-20PI-NP-2-0	Pulse-train input type with differential line driver support	(-)	DC24V	Maximum: 2A	-	See the ROBO Cylinder general catalog
Pulse-train input type (Open collector)		PCON-PO-20SPI-NP-2-0 PCON-PO-20PI-NP-2-0	Pulse-train input type with open collector support					
Serial communication type		PCON-SE-20SPI-N-0-0 PCON-SE-20PI-N-0-0	Dedicated to serial communication	64 points				
Field network type		RPCON-20SP RPCON-20P	Dedicated to a field network	768 points				
Program control type		PSEL-C-1-20SPI-NP-2-0 PSEL-C-1-20PI-NP-2-0	Program operation is supported. Up to two axes can be operated.	1500 points				

* This is for the single-axis PSEL
 * ① indicates the power-supply voltage type (1: 100 V/2: 100 to 240 V).



RCP3-RA2BC

ROBO Cylinder Mini Rod type Motor Unit Coupling type Actuator Width 28mm Pulse Motor
Ball Screw Specification /Lead Screw Specification

Model Description	RCP3	RA2BC	I						
	Series	Type	Encoder type	Motor type	Lead	Stroke	Compatible controllers	Cable length	Option
			I: Incremental specification * Model number is "I" when used with simple absolute unit.	20P: Pulse Motor 20□ size Standard type 20SP: Pulse Motor 20□ size High-thrust type	6: Ball screw 6mm 4: Ball screw 4mm 2: Ball screw 2mm 1: Ball screw 1mm 6S: Lead screw 6mm 4S: Lead screw 4mm 2S: Lead screw 2mm	25: 25mm ? : 150: 150mm (every 25mm)	P1: PCON RPCON PSEL P3: PMEC PSEP	N: None P: 1m S: 3m M: 5m X□□: Length Designation	B: Brake NM: Reversed-home specification

* See page 14 for details on the model descriptions.

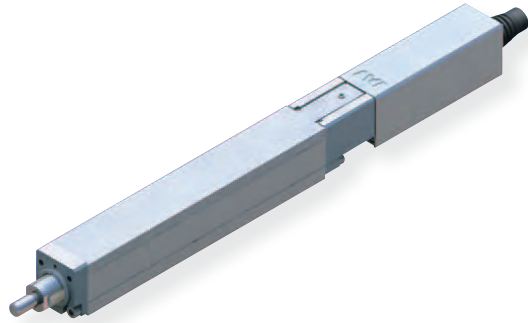

- POINT**
Notes on selection
- (1) The payload is the value when the actuator is operated at an acceleration of 0.3 G (0.2 G for the lead screw specification, if used vertically). The acceleration limit is the value indicated above.
 - (2) The horizontal payload is the value when used in combination with an external guide. Please note that if an external force is applied to the rod in a direction other than the proper direction the rod travels, the detent may get damaged.
 - (3) The maximum pushing force is the value when the actuator is operated at a speed of 5 mm/s.
 - (4) Service life decreases significantly if used in a dusty environment.

Correlation Diagrams of Speed and Load Capacity

With the RCP3 series, due to the characteristics of the pulse motor, load capacity decreases as the speed increases. Use the chart below to confirm that the desired speed and load capacity requirements are met.

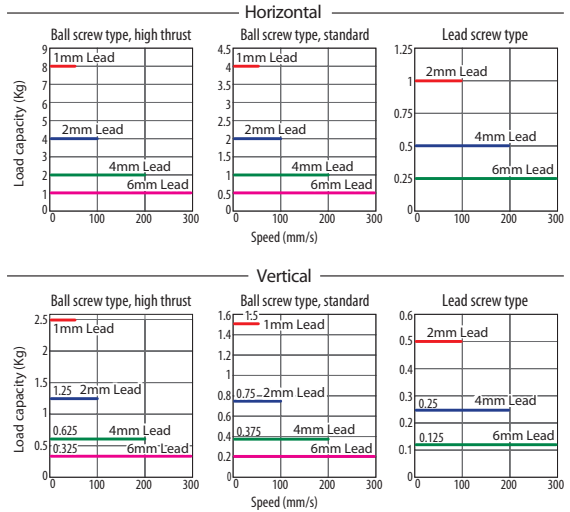

Actuator Specifications Table

Leads and Payloads

Model	Motor type	Feed screw	Lead (mm)	Maximum payload Horizontal (kg) / Vertical (kg)	Maximum pushing force (N)	Positioning repeatability (mm)	Stroke (mm)
RCP3-RA2BC-I-20SP-6-①-②-③-④	High thrust	Ball screw	6	1 / 0.325	See page 126.	±0.02	25 to 150 (every 25mm)
RCP3-RA2BC-I-20SP-4-①-②-③-④			4	2 / 0.625			
RCP3-RA2BC-I-20SP-2-①-②-③-④			2	4 / 1.25			
RCP3-RA2BC-I-20SP-1-①-②-③-④			1	8 / 2.5			
RCP3-RA2BC-I-20P-6-①-②-③-④	Standard	Ball screw	6	0.5 / 0.2	See page 126.	±0.02	25 to 150 (every 25mm)
RCP3-RA2BC-I-20P-4-①-②-③-④			4	1 / 0.375			
RCP3-RA2BC-I-20P-2-①-②-③-④			2	2 / 0.75			
RCP3-RA2BC-I-20P-1-①-②-③-④			1	4 / 1.5			
RCP3-RA2BC-I-20P-6S-①-②-③-④	Standard	Lead screw	6	0.25 / 0.125	See page 126.	±0.05	25 to 150 (every 25mm)
RCP3-RA2BC-I-20P-4S-①-②-③-④			4	0.5 / 0.25			
RCP3-RA2BC-I-20P-2S-①-②-③-④			2	1 / 0.5			

Legend ① Stroke ② Compatible controllers ③ Cable length ④ Option

Stroke and Maximum Speed

Lead	Stroke	25 (mm)	50~100 (mm)	75~150 (mm)
Ball screw	6	180	280	300
	4	180	200	
	2	100		
	1	50		
Lead screw	6	180	280	300
	4	180	200	
	2	100		

(unit: mm/s)

① Stroke list

① Stroke (mm)	Standard price		
	Feed screw		
	High thrust type	Standard type	Lead screw
25	—	—	—
50	—	—	—
75	—	—	—
100	—	—	—
125	—	—	—
150	—	—	—

④ Options

Title	Option code	See page	Standard price
Brake	B	—	—
Reversed-home specification	NM	—	—

③ Cable Length

Type	Cable symbol	Standard price
Standard type (Robot cable)	P (1m)	—
	S (3m)	—
	M (5m)	—
Special length	X06 (6m) ~ X10 (10m)	—
	X11 (11m) ~ X15 (15m)	—
	X16 (16m) ~ X20 (20m)	—

* The standard cable for the RCP3 is the robot cable.

Actuator Specifications

Item	Description
Drive System	Ball screw/Lead screw, ø6mm, rolled C10
Lost motion	Ball screw: 0.1mm or less/Lead screw: 0.3mm or less (default value)
Base	Material: Aluminum, white alumite treated
Guide	Slide guide
Ambient operating temperature, humidity	0 to 40°C, 85% RH or less (Non-condensing)
Service life	Lead screw specification Horizontal: 5 million cycles Vertical: 10 million cycles

Dimensional Drawings

(Brake-equipped)



- *1 Connect the motor and encoder cables.
- *2 During home return, be careful to avoid interference from peripheral objects because the slider travels until the mechanical end.
- *3 The orientation of the nut varies depending on the product.

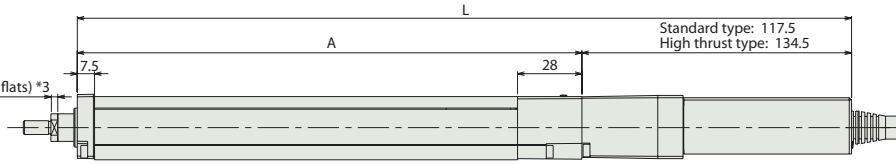

(No brake)

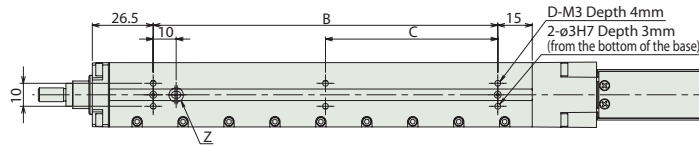
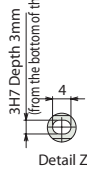
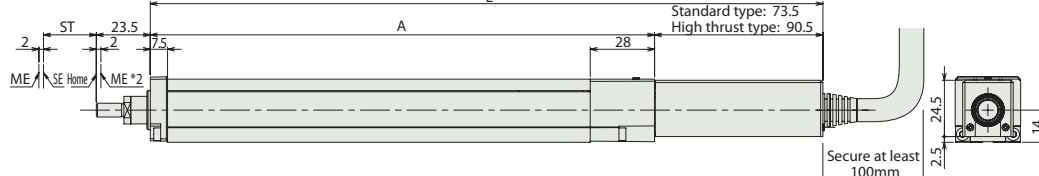
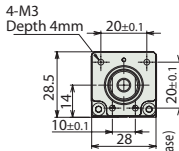
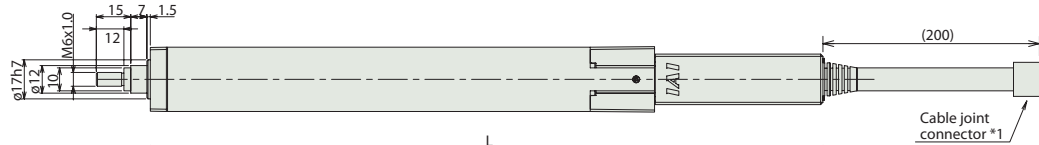

ST : Stroke
ME : Mechanical end
SE : Stroke end
* Brake equipped models are 0.1kg heavier.

Dimensions of nut at tip of rod

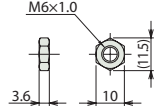

■ Dimensions and Weight by Stroke

		Stroke	25	50	75	100	125	150
Standard type	No brake	L	168	193	218	243	268	293
	Brake-equipped	L	212	237	262	287	312	337
High thrust type	No brake	L	185	210	235	260	285	310
	Brake-equipped	L	229	254	279	304	329	354
A			94.5	119.5	144.5	169.5	194.5	219.5
B			25	50	75	100	125	150
C			0	0	0	50	62.5	75
D			4	4	4	6	6	6
Mass (kg)			0.36	0.39	0.42	0.45	0.48	0.51

② Compatible Controllers

RCP3 series actuators can be operated with the controllers indicated below. Select the type according to your intended application.

Title	External View	Model	Features	Maximum number of positioning points	Input power	Power-supply capacity	Standard price	Reference Page
Solenoid valve type		PMEC-C-20SPI-NP-2-0① PMEC-C-20PI-NP-2-0①	Easy-to-use controller, even for beginners	3 points	AC100V AC200V	See the ROBO Cylinder general catalog.	-	→ P131
	Splash-proof solenoid valve type		PSEP-C-20SPI-NP-2-0 PSEP-C-20PI-NP-2-0					
Positioner type			PCON-C-20SPI-NP-2-0 PCON-C-20PI-NP-2-0	Up to 512 positioning points are supported.	512 points	-	-	See the ROBO Cylinder general catalog
Safety-compliant positioner type		PCON-CG-20SPI-NP-2-0 PCON-CG-20PI-NP-2-0						
Pulse-train input type (Differential line driver)		PCON-PL-20SPI-NP-2-0 PCON-PL-20PI-NP-2-0	Pulse-train input type with differential line driver support	(-)	DC24V	Maximum: 2A	-	See the ROBO Cylinder general catalog
Pulse-train input type (Open collector)		PCON-PO-20SPI-NP-2-0 PCON-PO-20PI-NP-2-0	Pulse-train input type with open collector support					
Serial communication type		PCON-SE-20SPI-N-0-0 PCON-SE-20PI-N-0-0	Dedicated to serial communication	64 points	-	-	-	-
Field network type		RPCON-20SP RPCON-20P	Dedicated to a field network	768 points				
Program control type		PSEL-C-1-20SPI-NP-2-0 PSEL-C-1-20PI-NP-2-0	Program operation is supported. Up to two axes can be operated.	1500 points	-	-	-	-

* This is for the single-axis PSEL
* ① indicates the power-supply voltage type (1: 100 V/2: 100 to 240 V).

RCP3-RA2AR

ROBO Cylinder Mini Rod type Side-Mounted Motor type Actuator Width 58mm Pulse Motor
Ball Screw Specification /Lead Screw Specification

Model Description	RCP3 — RA2AR — I — — — — — — — — 							
Series	Type	Encoder type	Motor type	Lead	Stroke	Compatible controllers	Cable length	Option
		I: Incremental specification * Model number is "I" when used with simple absolute unit.	20P: Pulse Motor 20□ size Standard type 20SP: Pulse Motor 20□ size High-thrust type	4: Ball screw 4mm 2: Ball screw 2mm 1: Ball screw 1mm 4S: Lead screw 4mm 2S: Lead screw 2mm 1S: Lead screw 1mm	25: 25mm ? 100: 100mm (every 25mm)	P1: PCON RPCON PSEL P3: PMEC PSEP	N: None P: 1m S: 3m M: 5m X□□: Length Designation	See options table below. *Be sure to specify which side the motor is to be mounted (ML/MR).

* See page 14 for details on the model descriptions.

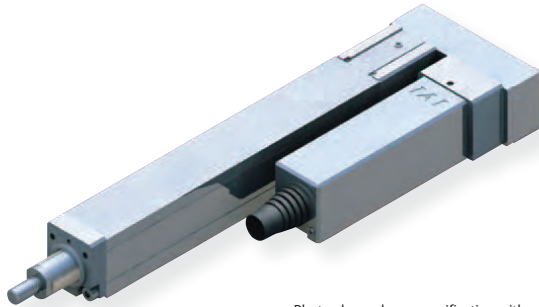
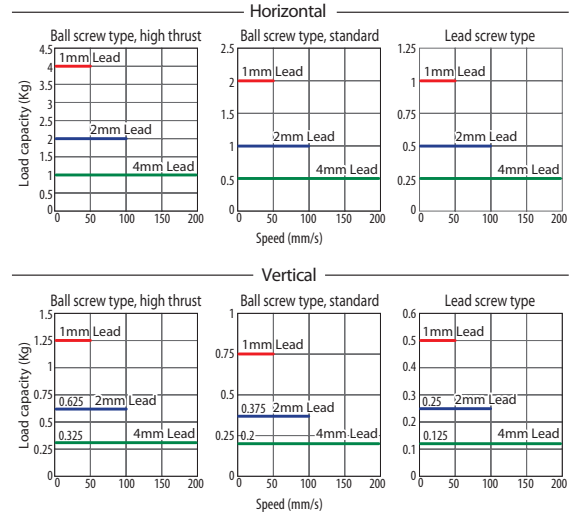

Photo above shows specification with motor side-mounted to the left (ML Option).

- POINT**
Notes on selection
- (1) The payload is the value when the actuator is operated at an acceleration of 0.3 G (0.2 G for the lead screw specification, if used vertically). The acceleration limit is the value indicated above.
 - (2) The horizontal payload is the value when used in combination with an external guide. Please note that if an external force is applied to the rod in a direction other than the proper direction the rod travels, the detent may get damaged.
 - (3) The maximum pushing force is the value when the actuator is operated at a speed of 5 mm/s.
 - (4) Service life decreases significantly if used in a dusty environment.

Correlation Diagrams of Speed and Load Capacity

With the RCP3 series, due to the characteristics of the pulse motor, load capacity decreases as the speed increases. Use the chart below to confirm that the desired speed and load capacity requirements are met.



Actuator Specifications Table

Leads and Payloads

Model	Motor type	Feed screw	Lead (mm)	Maximum payload		Maximum pushing force (N)	Positioning repeatability (mm)	Stroke (mm)
				Horizontal (kg)	Vertical (kg)			
RCP3-RA2AR-I-20SP-4	High thrust	Ball screw	4	1	0.325	See page 126.	±0.02	25 to 100 (every 25mm)
RCP3-RA2AR-I-20SP-2			2	2	0.625			
RCP3-RA2AR-I-20SP-1			1	4	1.25			
RCP3-RA2AR-I-20P-4			Standard	Ball screw	4			
RCP3-RA2AR-I-20P-2	2	1			0.375			
RCP3-RA2AR-I-20P-1	1	2			0.75			
RCP3-RA2AR-I-20P-4S	Standard	Lead screw			4			
RCP3-RA2AR-I-20P-2S			2	0.5	0.25			
RCP3-RA2AR-I-20P-1S			1	1	0.5			

Legend ① Stroke ② Compatible controllers ③ Cable length ④ Option

Stroke and Maximum Speed

Lead	Stroke	Maximum Speed	
		25 (mm)	50~100 (mm)
Ball screw	4	180	200
	2	100	
	1	50	
Lead screw	4	180	200
	2	100	
	1	50	

(unit: mm/s)

① Stroke list

① Stroke (mm)	Standard price		
	Feed screw		
	Ball screw		Lead screw
High thrust type	Standard type		
25	—	—	—
50	—	—	—
75	—	—	—
100	—	—	—

④ Options

Title	Option code	See page	Standard price
Brake	B	—	—
Side-mounted motor to the left (standard)	ML	—	—
Side-mounted motor to the right	MR	—	—
Reversed-home specification	NM	—	—

③ Cable Length

Type	Cable symbol	Standard price
Standard type (Robot cable)	P (1m)	—
	S (3m)	—
	M (5m)	—
Special length	X06 (6m) ~ X10 (10m)	—
	X11 (11m) ~ X15 (15m)	—
	X16 (16m) ~ X20 (20m)	—
		—

* The standard cable for the RCP3 is the robot cable.

Actuator Specifications

Item	Description
Drive System	Ball screw/Lead screw, ø4mm, rolled C10
Lost motion	Ball screw: 0.1mm or less/Lead screw: 0.3mm or less (default value)
Base	Material: Aluminum, white alumite treated
Guide	Slide guide
Ambient operating temperature, humidity	0 to 40°C, 85% RH or less (Non-condensing)
Service life	Lead screw specification
	Horizontal: 10 million cycles Vertical: 5 million cycles

Dimensional Drawings

*The drawing below shows the specification of the motor side-mounted to the left.

(Brake-equipped)

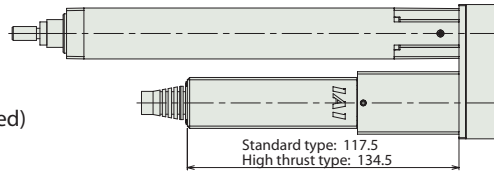

- *1 Connect the motor and encoder cables.
- *2 During home return, be careful to avoid interference from peripheral objects because the slider travels until the mechanical end.
- *3 The orientation of the nut varies depending on the product.

(No brake)

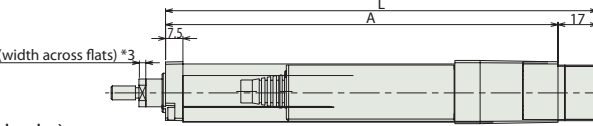

*Please note: When installing the brake unit, the bottom of the brake housing protrudes by 1mm beyond the actuator main body.

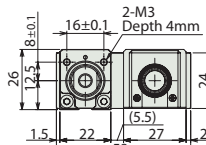
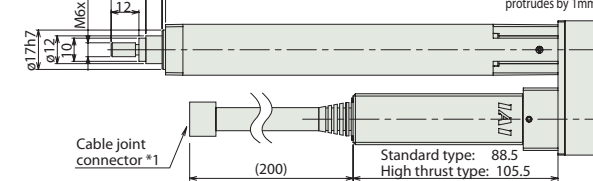

3H7 Depth 3mm (from the bottom of the base)

Detail Z

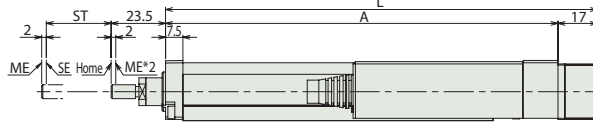
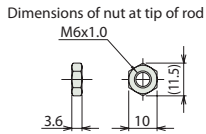

(Secure at least 100mm)

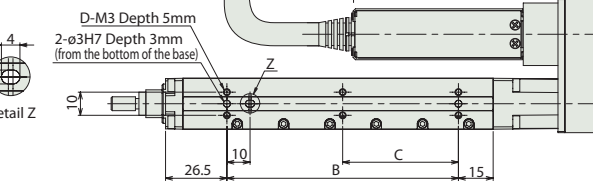

ST : Stroke
ME : Mechanical end
SE : Stroke end

* Brake equipped models are 0.1kg heavier.

■ Dimensions and Weight by Stroke

Stroke	25	50	75	100
L	111.5	136.5	161.5	186.5
A	94.5	119.5	144.5	169.5
B	25	50	75	100
C	0	0	0	50
D	4	4	4	6
Mass (kg)	0.34	0.36	0.39	0.4

② Compatible Controllers

RCP3 series actuators can be operated with the controllers indicated below. Select the type according to your intended application.

Title	External View	Model	Features	Maximum number of positioning points	Input power	Power-supply capacity	Standard price	Reference Page
Solenoid valve type		PMEC-C-20SPI-NP-2-0① PMEC-C-20PI-NP-2-0①	Easy-to-use controller, even for beginners	3 points	AC100V AC200V	See the ROBO Cylinder general catalog.	-	→ P131
		PSEP-C-20SPI-NP-2-0 PSEP-C-20PI-NP-2-0	Operable with the same signal as a solenoid valve. Supports both single and double solenoid types. No homing necessary with the simple absolute type.					→ P141
Splash-proof solenoid valve type		PSEP-CW-20SPI-NP-2-0 PSEP-CW-20PI-NP-2-0						
Positioner type		PCON-C-20SPI-NP-2-0 PCON-C-20PI-NP-2-0	Up to 512 positioning points are supported.	512 points				-
Safety-compliant positioner type		PCON-CG-20SPI-NP-2-0 PCON-CG-20PI-NP-2-0						-
Pulse-train input type (Differential line driver)		PCON-PL-20SPI-NP-2-0 PCON-PL-20PI-NP-2-0	Pulse-train input type with differential line driver support	(-)	DC24V	Maximum: 2A		-
Pulse-train input type (Open collector)		PCON-PO-20SPI-NP-2-0 PCON-PO-20PI-NP-2-0	Pulse-train input type with open collector support					-
Serial communication type		PCON-SE-20SPI-N-0-0 PCON-SE-20PI-N-0-0	Dedicated to serial communication	64 points				-
Field network type		RPCON-20SP RPCON-20P	Dedicated to a field network	768 points				-
Program control type		PSEL-C-1-20SPI-NP-2-0 PSEL-C-1-20PI-NP-2-0	Program operation is supported. Up to two axes can be operated.	1500 points				-

* This is for the single-axis PSEL
* ① indicates the power-supply voltage type (1: 100 V/2: 100 to 240 V).

Mini Slider type

Mini Rod type

Mini Table type

Mini Linear type

Controller

Compact

Wide

Flat

Coupling

Side-mounted

RCP3-RA2BR

ROBO Cylinder Mini Rod type Side-Mounted Motor type Actuator Width 59.5mm Pulse Motor
Ball Screw Specification /Lead Screw Specification

Model Description	RCP3 — RA2BR — I — — — — — — — — — 							
Series	Type	Encoder type	Motor type	Lead	Stroke	Compatible controllers	Cable length	Option
		I: Incremental specification * Model number is "I" when used with simple absolute unit.	20P: Pulse Motor 20□ size Standard type 20SP: Pulse Motor 20□ size High-thrust type	6: Ball screw 6mm 4: Ball screw 4mm 2: Ball screw 2mm 1: Ball screw 1mm 6S: Lead screw 6mm 4S: Lead screw 4mm 2S: Lead screw 2mm	25: 25mm 7 150: 150mm (every 25mm)	P1: PCON RPCON PSEL P3: PMEC PSEP	N: None P: 1m S: 3m M: 5m X□□: Length Designation	See options table below. *Be sure to specify which side the motor is to be mounted (ML/MR).

* See page 14 for details on the model descriptions.

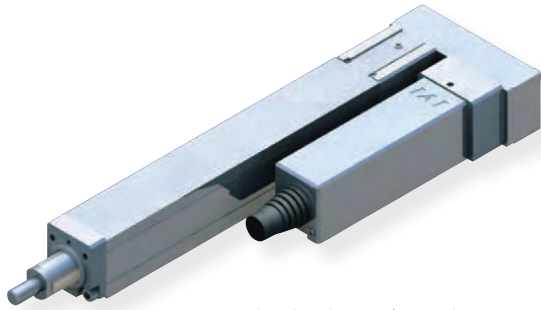

Photo above shows specification with motor side-mounted to the left (ML Option).

- POINT**
Notes on selection

 - The payload is the value when the actuator is operated at an acceleration of 0.3 G (0.2 G for the lead screw specification, if used vertically). The acceleration limit is the value indicated above.
 - The horizontal payload is the value when used in combination with an external guide. Please note that if an external force is applied to the rod in a direction other than the proper direction the rod travels, the detent may get damaged.
 - The maximum pushing force is the value when the actuator is operated at a speed of 5 mm/s.
 - Service life decreases significantly if used in a dusty environment.

Correlation Diagrams of Speed and Load Capacity

With the RCP3 series, due to the characteristics of the pulse motor, load capacity decreases as the speed increases. Use the chart below to confirm that the desired speed and load capacity requirements are met.

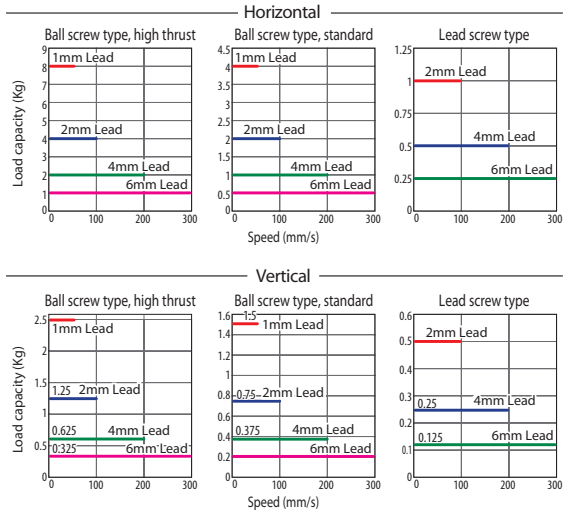

Actuator Specifications Table

Leads and Payloads

Model	Motor type	Feed screw	Lead (mm)	Maximum payload Horizontal (kg) / Vertical (kg)	Maximum pushing force (N)	Positioning repeatability (mm)	Stroke (mm)
RCP3-RA2BR-I-20SP-6-①-②-③-④	High thrust	Ball screw	6	1 / 0.325	See page 126.	±0.02	25 to 150 (every 25mm)
RCP3-RA2BR-I-20SP-4-①-②-③-④			4	2 / 0.625			
RCP3-RA2BR-I-20SP-2-①-②-③-④			2	4 / 1.25			
RCP3-RA2BR-I-20SP-1-①-②-③-④			1	8 / 2.5			
RCP3-RA2BR-I-20P-6-①-②-③-④	Standard	Ball screw	6	0.5 / 0.2			
RCP3-RA2BR-I-20P-4-①-②-③-④			4	1 / 0.375			
RCP3-RA2BR-I-20P-2-①-②-③-④			2	2 / 0.75			
RCP3-RA2BR-I-20P-1-①-②-③-④			1	4 / 1.5			
RCP3-RA2BR-I-20P-6S-①-②-③-④	Standard	Lead screw	6	0.25 / 0.125			
RCP3-RA2BR-I-20P-4S-①-②-③-④			4	0.5 / 0.25			
RCP3-RA2BR-I-20P-2S-①-②-③-④			2	1 / 0.5			

Legend ① Stroke ② Compatible controllers ③ Cable length ④ Option

Stroke and Maximum Speed

Lead	Stroke	25 (mm)	50~100 (mm)	75~150 (mm)
Ball screw	6	180	280	300
	4	180	200	
	2	100		
	1	50		
Lead screw	6	180	280	300
	4	180	200	
	2	100		

(unit: mm/s)

① Stroke list

① Stroke (mm)	Standard price		
	Feed screw		
	Ball screw		Lead screw
High thrust type	Standard type		
25	—	—	—
50	—	—	—
75	—	—	—
100	—	—	—
125	—	—	—
150	—	—	—

④ Options

Title	Option code	See page	Standard price
Brake	B	—	—
Side-mounted motor to the left (standard)	ML	—	—
Side-mounted motor to the right	MR	—	—
Reversed-home specification	NM	—	—

③ Cable Length

Type	Cable symbol	Standard price
Standard type (Robot cable)	P (1m)	—
	S (3m)	—
	M (5m)	—
Special length	X06 (6m) ~ X10 (10m)	—
	X11 (11m) ~ X15 (15m)	—
	X16 (16m) ~ X20 (20m)	—
		—

* The standard cable for the RCP3 is the robot cable.

Actuator Specifications

Item	Description
Drive System	Ball screw/Lead screw, ø6mm, rolled C10
Lost motion	Ball screw: 0.1mm or less/Lead screw: 0.3mm or less (default value)
Base	Material: Aluminum, white alumite treated
Guide	Slide guide
Ambient operating temperature, humidity	0 to 40°C, 85% RH or less (Non-condensing)
Service life	Lead screw specification Horizontal: 10 million cycles Vertical: 5 million cycles

Dimensional Drawings

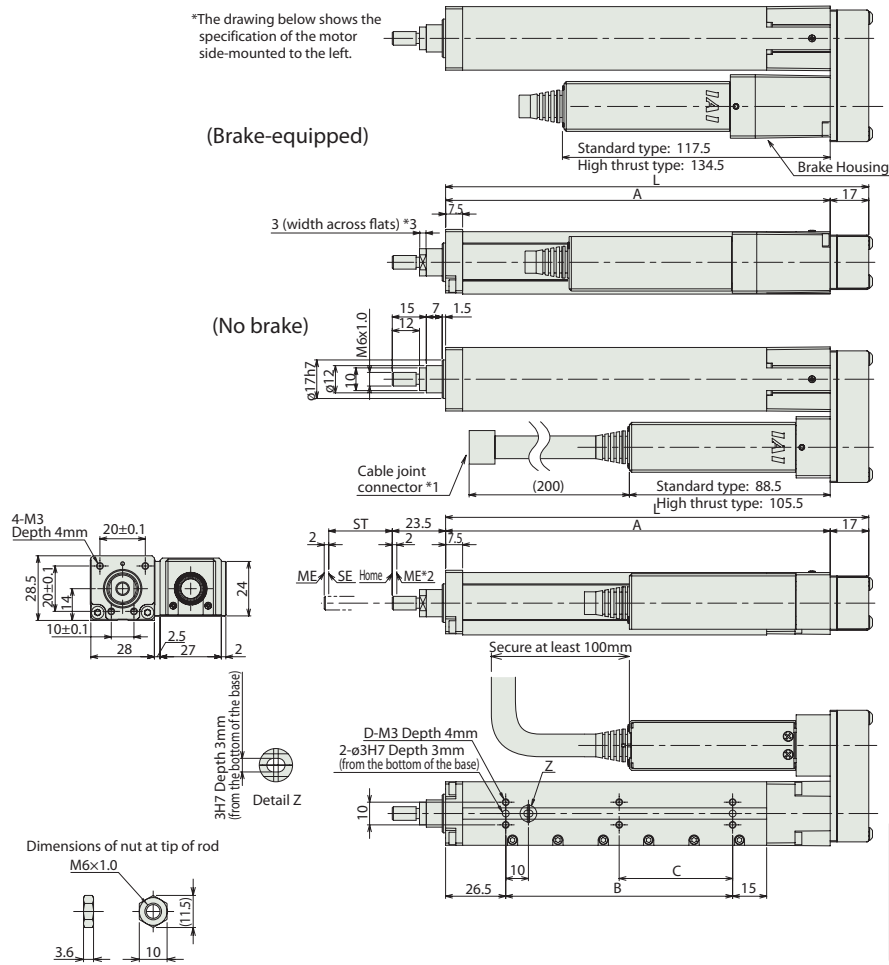

- *1 Connect the motor and encoder cables.
- *2 During home return, be careful to avoid interference from peripheral objects because the slider travels until the mechanical end.
- *3 The orientation of the nut varies depending on the product.

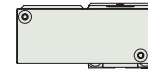

ST : Stroke
ME : Mechanical end
SE : Stroke end

* Brake equipped models are 0.1kg heavier.

■ Dimensions and Weight by Stroke

Stroke	25	50	75	100	125	150
L	111.5	136.5	161.5	186.5	211.5	236.5
A	94.5	119.5	144.5	169.5	194.5	219.5
B	25	50	75	100	125	150
C	0	0	0	50	62.5	75
D	4	4	4	6	6	6
Mass (kg)	0.38	0.41	0.44	0.47	0.5	0.53

② Compatible Controllers

RCP3 series actuators can be operated with the controllers indicated below. Select the type according to your intended application.

Title	External View	Model	Features	Maximum number of positioning points	Input power	Power-supply capacity	Standard price	Reference Page
Solenoid valve type		PMEC-C-20SPI-NP-2-① PMEC-C-20PI-NP-2-①	Easy-to-use controller, even for beginners	3 points	AC100V AC200V	See the ROBO Cylinder general catalog.	-	→ P131
		PSEP-C-20SPI-NP-2-0 PSEP-C-20PI-NP-2-0	Operable with the same signal as a solenoid valve. Supports both single and double solenoid types. No homing necessary with the simple absolute type.					→ P141
Splash-proof solenoid valve type		PSEP-CW-20SPI-NP-2-0 PSEP-CW-20PI-NP-2-0	Operable with the same signal as a solenoid valve. Supports both single and double solenoid types. No homing necessary with the simple absolute type.	512 points	DC24V	Maximum: 2A	-	See the ROBO Cylinder general catalog
Positioner type		PCON-C-20SPI-NP-2-0 PCON-C-20PI-NP-2-0	Up to 512 positioning points are supported.					
Safety-compliant positioner type		PCON-CG-20SPI-NP-2-0 PCON-CG-20PI-NP-2-0	Up to 512 positioning points are supported.	(-)	DC24V	Maximum: 2A	-	See the ROBO Cylinder general catalog
Pulse-train input type (Differential line driver)		PCON-PL-20SPI-NP-2-0 PCON-PL-20PI-NP-2-0	Pulse-train input type with differential line driver support					
Pulse-train input type (Open collector)		PCON-PO-20SPI-NP-2-0 PCON-PO-20PI-NP-2-0	Pulse-train input type with open collector support	64 points	DC24V	Maximum: 2A	-	See the ROBO Cylinder general catalog
Serial communication type		PCON-SE-20SPI-N-0-0 PCON-SE-20PI-N-0-0	Dedicated to serial communication					
Field network type		RPCON-20SP RPCON-20P	Dedicated to a field network	768 points	DC24V	Maximum: 2A	-	See the ROBO Cylinder general catalog
Program control type		PSEL-C-1-20SPI-NP-2-0 PSEL-C-1-20PI-NP-2-0	Program operation is supported. Up to two axes can be operated.	1500 points				

* This is for the single-axis PSEL
* ① indicates the power-supply voltage type (1: 100 V/2: 100 to 240 V).

RCA2-RA2AC

ROBO Cylinder Mini Rod type Motor Unit Coupling type Actuator Width 18mm 24V Servo Motor Ball Screw Specification

Model Description	RCA2 — RA2AC — I — 5 — <input type="text"/> — <input type="text"/> — A3 — <input type="text"/> — <input type="text"/>							
Series	Type	Encoder type	Motor type	Lead	Stroke	Compatible controllers	Cable length	Option
		I: Incremental specification * Model number is "I" when used with simple absolute unit.	5: Servo motor 5W	4: 4mm 2: 2mm 1: 1mm	25: 25mm ? 100: 100mm (every 25mm)	A3: ASEP	N: None P: 1m S: 3m M: 5m X <input type="text"/> : Length Designation	See options table below.

* See page 14 for details on the model descriptions.

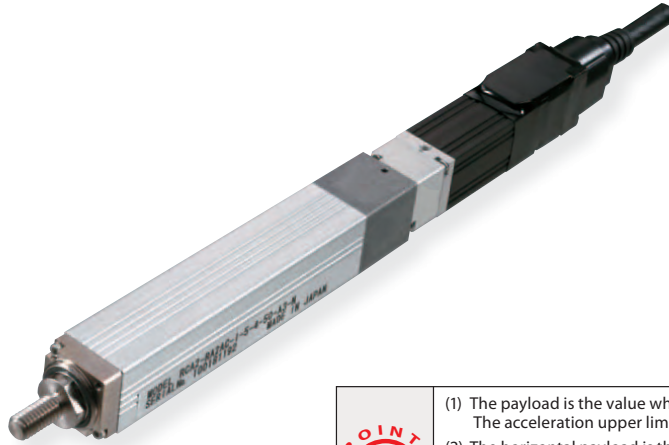

- POINT**
Notes on selection
- (1) The payload is the value when operated at 0.3G acceleration. The acceleration upper limit is the value indicated above.
 - (2) The horizontal payload is the value when used in combination with an external guide. Please note that if an external force is applied to the rod in a direction other than the proper direction the rod travels, the detent may get damaged.
 - (3) Take note that, since there is no brake, the slider may come down when the power is turned off if the actuator is used vertically.

Actuator Specifications Table

Leads and Payloads

Model	Motor output (W)	Feed screw	Lead (mm)	Maximum payload		Rated thrust (N)	Positioning repeatability (mm)	Stroke (mm)
				Horizontal (kg)	Vertical (kg)			
RCA2-RA2AC-I-5-4-①-A3-②-③	5	Ball screw	4	0.5	0.25	21.4	±0.02	25 to 100 (every 25mm)
RCA2-RA2AC-I-5-2-①-A3-②-③			2	1	0.5	42.3		
RCA2-RA2AC-I-5-1-①-A3-②-③			1	2	1	85.5		

Legend ① Stroke ② Cable length ③ Option

Stroke and Maximum Speed

Lead	Stroke	25 (mm)	50~100 (mm)
		Ball screw	4
	2	100	
	1	50	

(unit: mm/s)

① Stroke list

① Stroke (mm)	Standard price
25	—
50	—
75	—
100	—

② Cable Length

Type	Cable symbol	Standard price
Standard type (Robot cable)	P (1m)	—
	S (3m)	—
	M (5m)	—
Special length	X06 (6m) ~ X10 (10m)	—
	X11 (11m) ~ X15 (15m)	—
	X16 (16m) ~ X20 (20m)	—
		—

* The standard cable for the RCA2 is the robot cable.

③ Options

Title	Option code	See page	Standard price
Reversed-home specification	NM	—	—

Actuator Specifications

Item	Description
Drive System	Ball screw, ø4 mm, rolled C10
Lost motion	0.1 mm or less
Base	Material: Aluminum, white alumite treated
Rod non-rotation preciseness	±3.0°
Ambient operating temperature, humidity	0 to 40°C, 85% RH or less (Non-condensing)
Service life	5,000km

Dimensional Drawings

- *1 Connect the motor and encoder cables.
- *2 During home return, be careful to avoid interference from peripheral objects because the slider travels until the mechanical end.
- *3 The orientation of the nut varies depending on the product.

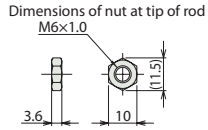
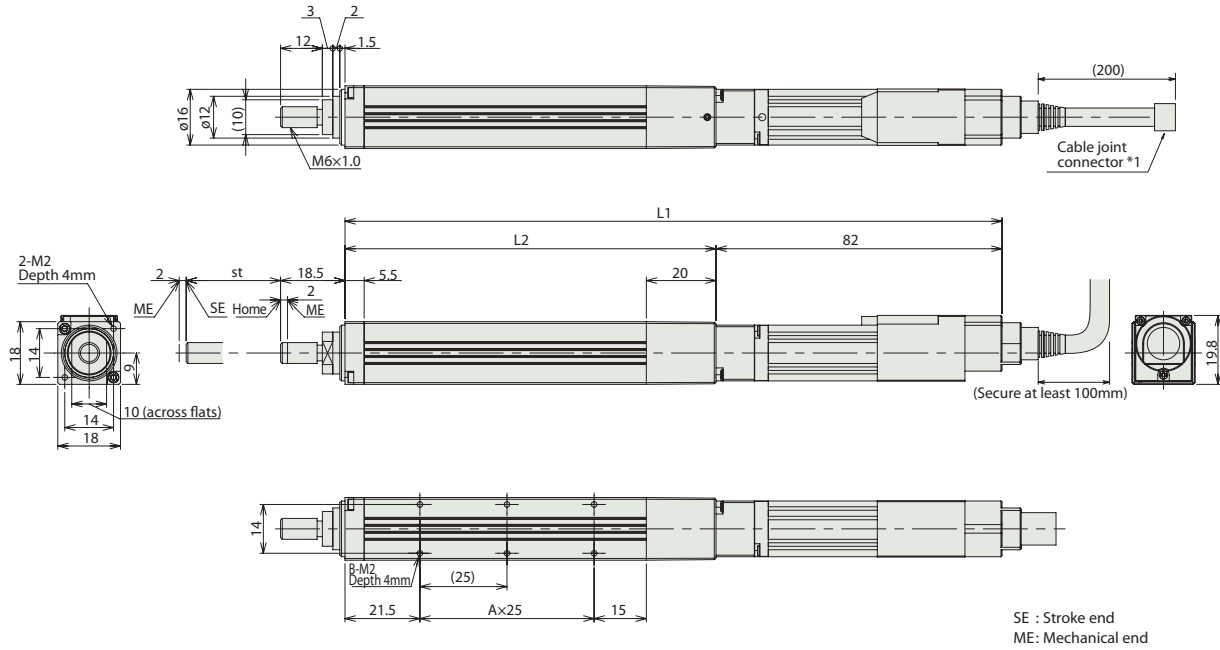

■ Dimensions and Weight by Stroke

Stroke	25	50	75	100
L1	163.5	188.5	213.5	238.5
L2	81.5	106.5	131.5	156.5
A	1	2	3	4
B	4	6	8	10
Mass (kg)	0.17	0.19	0.2	0.22

Compatible Controllers

RCA2 series actuators can be operated with the controllers indicated below. Select the type according to your intended application.

Title	External View	Model	Features	Maximum number of positioning points	Input power	Power-supply capacity	Standard price	Reference Page
Solenoid valve type		ASEP-C-5SI-NP-2-0	Operable with the same signal as a solenoid valve. Supports both single and double solenoid types.	3 points	DC24V	(Standard specification) Rated: 1.5 A Maximum: 2.5 A	-	→ P141
Splash-proof solenoid valve type		ASEP-CW-5SI-NP-2-0					-	



RCA2-SA2AR

ROBO Cylinder Mini Rod type Side-Mounted Motor type Actuator Width 41mm 24V Servo Motor Ball Screw Specification

Model Description	RCA2 — SA2AR — I — 5 — <input type="text"/> — <input type="text"/> — A3 — <input type="text"/> — <input type="text"/>							
Series	Type	Encoder type	Motor type	Lead	Stroke	Compatible controllers	Cable length	Option
I: Incremental specification * Model number is "I" when used with simple absolute unit.	S: Servo motor 5W	4: 4mm 2: 2mm 1: 1mm	25: 25mm ? 100: 100mm (every 25mm)	A3: ASEP	N: None P: 1m S: 3m M: 5m X <input type="checkbox"/> : Length Designation	See options table below. *Be sure to specify which side the motor is to be mounted (ML/MR).		

* See page 14 for details on the model descriptions.

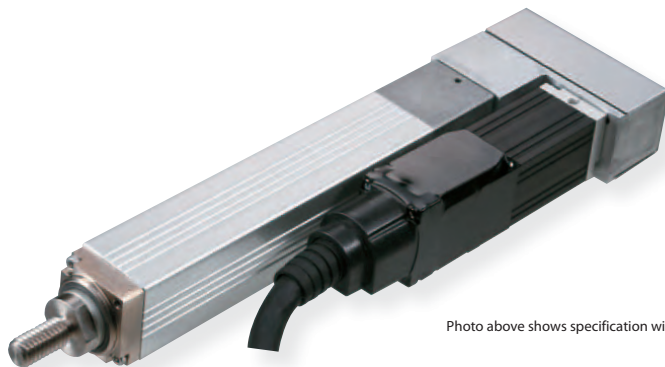

Photo above shows specification with motor side-mounted to the left (ML Option).

- POINT**
Notes on selection

 - (1) The payload is the value when operated at 0.3G acceleration. The acceleration upper limit is the value indicated above.
 - (2) The horizontal payload is the value when used in combination with an external guide. Please note that if an external force is applied to the rod in a direction other than the proper direction the rod travels, the detent may get damaged.
 - (3) Take note that, since there is no brake, the slider may come down when the power is turned off if the actuator is used vertically.

Actuator Specifications Table

Leads and Payloads

Model	Motor output (W)	Feed screw	Lead (mm)	Maximum payload		Rated thrust (N)	Positioning repeatability (mm)	Stroke (mm)
				Horizontal (kg)	Vertical (kg)			
RCA2-RA2AR-I-5-4-①-A3-②-③	5	Ball screw	4	0.5	0.25	21.4	±0.02	25 to 100 (every 25mm)
RCA2-RA2AR-I-5-2-①-A3-②-③			2	1	0.5	42.3		
RCA2-RA2AR-I-5-1-①-A3-②-③			1	2	1	85.5		

Legend ① Stroke ② Cable length ③ Option

Stroke and Maximum Speed

Lead	Stroke	25 (mm)	50~100 (mm)
		Ball screw	4
	2	100	
	1	50	

(unit: mm/s)

① Stroke list

① Stroke (mm)	Standard price
25	—
50	—
75	—
100	—

② Cable Length

Type	Cable symbol	Standard price
Standard type (Robot cable)	P (1m)	—
	S (3m)	—
	M (5m)	—
Special length	X06 (6m) ~ X10 (10m)	—
	X11 (11m) ~ X15 (15m)	—
	X16 (16m) ~ X20 (20m)	—

* The standard cable for the RCA2 is the robot cable.

③ Options

Title	Option code	See page	Standard price
Side-mounted motor to the left	ML	—	—
Side-mounted motor to the right	MR	—	—
Side-mounted motor to the top	MT	—	—
Reversed-home specification	NM	—	—

Actuator Specifications

Item	Description
Drive System	Ball screw, ø4mm, rolled C10
Lost motion	0.1 mm or less
Base	Material: Aluminum, white alumite treated
Rod non-rotation preciseness	±3.0°
Ambient operating temperature, humidity	0 to 40°C, 85% RH or less (Non-condensing)
Service life	5,000km

Dimensional Drawings

- *1 Connect the motor and encoder cables.
 - *2 During home return, be careful to avoid interference from peripheral objects because the slider travels until the mechanical end.
 - *3 The orientation of the nut varies depending on the product.
- *The drawing below shows the specification with motor side-mounted to the left (ML).

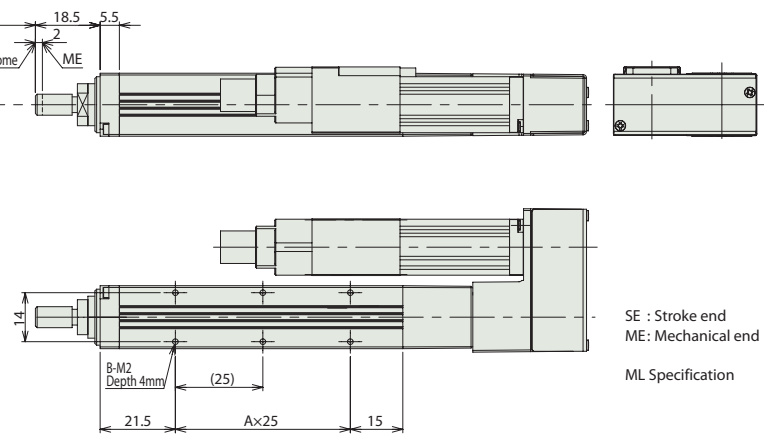
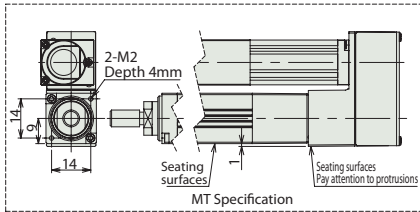
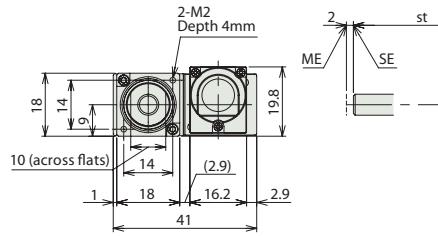
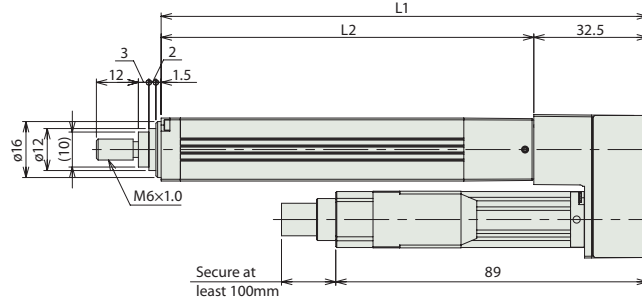

Dimensions of nut at tip of rod

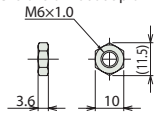

■ Dimensions and Weight by Stroke

Stroke	25	50	75	100
L1	114	139	164	189
L2	81.5	106.5	131.5	156.5
A	1	2	3	4
B	4	6	8	10
Mass (kg)	0.21	0.22	0.24	0.25

Compatible Controllers

RCA2 series actuators can be operated with the controllers indicated below. Select the type according to your intended application.

Title	External View	Model	Features	Maximum number of positioning points	Input power	Power-supply capacity	Standard price	Reference Page
Solenoid valve type		ASEP-C-5SI-NP-2-0	Operable with the same signal as a solenoid valve. Supports both single and double solenoid types.	3 points	DC24V	(Standard specification) Rated: 1.5 A Maximum: 2.5 A	-	→ P141
Splash-proof solenoid valve type		ASEP-CW-5SI-NP-2-0						

Mini Slider type

Mini Rod type

Mini Table type

Mini Linear Servo type

Controller

Compact

Wide

Flat

Coupling

Side-mounted

RCA2-RN3NA

ROBO Cylinder Mini Rod Type Short-Length Nut Mounting Type Actuator Width 28 mm 24V Servo Motor
Ball Screw Specification/Lead Screw Specification

Model Description	RCA2 — RN3NA — I — 10 — <input type="text"/> — <input type="text"/> — <input type="text"/> — <input type="text"/> — <input type="text"/>							
Series	Type	Encoder type	Motor type	Lead	Stroke	Compatible controllers	Cable length	Option
I: Incremental specification * Model number is "I" when used with simple absolute unit.	10: Servo motor 10W	4: Ball screw 4mm 2: Ball screw 2mm 1: Ball screw 1mm 4S: Lead screw 4mm 2S: Lead screw 2mm 1S: Lead screw 1mm	30: 30mm 50: 50mm	A1:ACON RACON ASEL A3:AMEC ASEP	N: None P: 1 m S: 3 m M: 5 m X□□: Length Designation	K2: Connector cable exits from the front LA: Power-saving specification		

* See page 14 for details on the model descriptions.

Power-saving specification

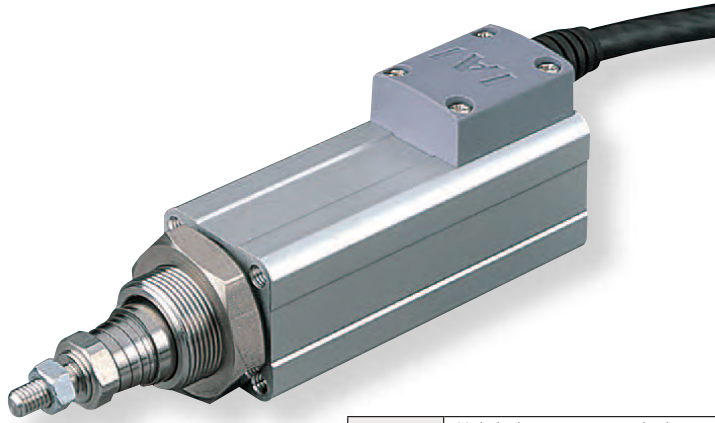

- POINT**
Notes on selection
- (1) The lead screw is not equipped with an anti-rotation device, so please attach a guide or similar locking device to the tip of the lead screw prior to use. (If there is no anti-rotation device attached, the lead screw cannot extend or retract.) When connecting the anti-rotation device and rod, do not use a floating joint.
 - (2) The horizontal payload is the value when the actuator uses an external guide.
 - (3) The payload is the value when the actuator is operated at an acceleration of 0.3 G (0.2G for lead 1, if used vertically and for lead screw specification). The acceleration limit is the value indicated above.
 - (4) Do not apply an external force on the rod in any direction other than the direction the rod is moving in.
 - (5) If the actuator is used vertically, pay attention to rod contact because the rod will come down when the power is turned off.

Actuator Specifications Table

Leads and Payloads

Model	Motor output (W)	Feed screw	Lead (mm)	Maximum payload		Rated thrust (N)	Positioning repeatability (mm)	Stroke (mm)
				Horizontal (kg)	Vertical (kg)			
RCA2-RN3NA-I-10-4-①-②-③-④	10	Ball screw	4	0.75	0.25	42.7	±0.02	30 50
RCA2-RN3NA-I-10-2-①-②-③-④			2	1.5	0.5	85.5		
RCA2-RN3NA-I-10-1-①-②-③-④			1	3	1	170.9		
RCA2-RN3NA-I-10-4S-①-②-③-④	10	Lead screw	4	0.25	0.125	25.1	±0.05	30 50
RCA2-RN3NA-I-10-2S-①-②-③-④			2	0.5	0.25	50.3		
RCA2-RN3NA-I-10-1S-①-②-③-④			1	1	0.5	100.5		

Legend ① Stroke ② Compatible Controllers ③ Cable length ④ Option

Stroke and Maximum Speed

Lead	Stroke	30 (mm)		50 (mm)	
		30 (mm)	50 (mm)	30 (mm)	50 (mm)
Ball screw	4	200			
	2	100			
	1	50			
Lead screw	4	200			
	2	100			
	1	50			

(unit: mm/s)

① Stroke list

Stroke (mm)	Standard price	
	Ball screw	Lead screw
30	—	—
50	—	—

④ Options

Title	Option code	See page	Standard price
Connector cable exits from the front	K2	—	—
Power-saving specification	LA	—	—

③ Cable Length

Type	Cable symbol	Standard price
Standard type (Robot cable)	P (1m)	—
	S (3m)	—
	M (5m)	—
Special length	X06 (6m) ~ X10 (10m)	—
	X11 (11m) ~ X15 (15m)	—
	X16 (16m) ~ X20 (20m)	—
		—

* The standard cable for the RCA2 is the robot cable.

Actuator Specifications

Item	Description
Drive System	Ball screw/Lead screw, ø4mm, rolled C10
Lost motion	Ball screw: 0.1mm or less Lead screw: 0.3 mm or less
Frame	Material: Aluminum, white alumite treated
Ambient operating temperature, humidity	0 to 40°C, 85% RH or less (Non-condensing)
Service life	Lead screw specification Horizontal specification: 10 million cycles, Vertical specification: 5 million cycles

Dimensional Drawings

- *1 Connect the motor and encoder cables.
- *2 During home return, be careful to avoid interference from peripheral objects because the rod travels until the mechanical end.
- *3 The orientation of the nut varies depending on the product.

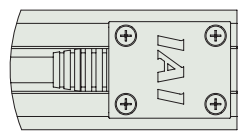
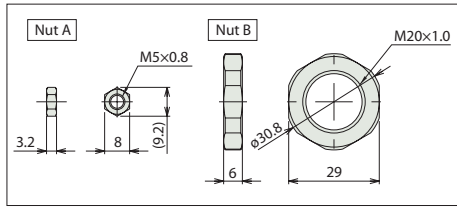
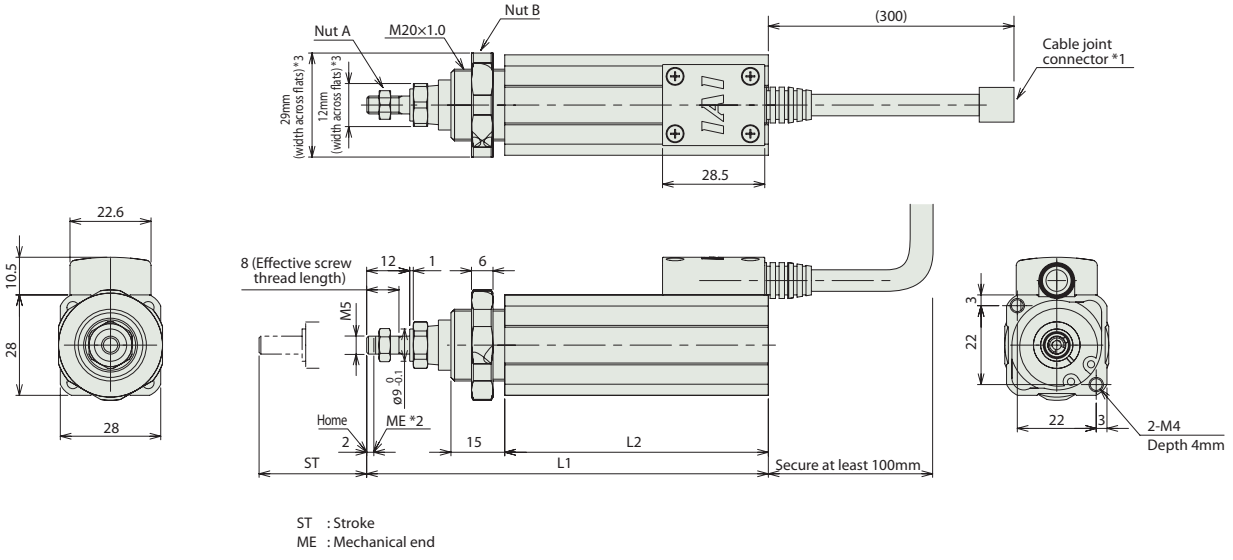

Changing the cable connector outlet direction
Model : K2
(Exits from the front)
* Rotate 180° relative to the standard specification.

Dimensions and Weight by Stroke

Stroke	30	50
L1	112	132
L2	73.5	93.5
Mass (kg)	0.25	0.27

Compatible Controllers

RCA2 series actuators can be operated with the controllers indicated below. Select the type according to your intended application.

Title	External View	Model	Features	Maximum number of positioning points	Input power	Power-supply capacity	Standard price	Reference Page
Solenoid valve type		AMEC-C-10①-NP-2-1	Easy-to-use controller, even for beginners	3 points	AC100V	Rated: 2.4A	-	→ P131
		ASEP-C-10①-NP-2-0	Operable with the same signal as a solenoid valve. Supports both single and double solenoid types. No homing necessary with the simple absolute type.					→ P141
Splash-proof solenoid valve type		ASEP-CW-10①-NP-2-0						
Positioner type		ACON-C-10①-NP-2-0	Up to 512 positioning points are supported.	512 points	DC24V	(Standard specification) Rated: 1.3A Maximum: 4.4 A	-	See the ROBO Cylinder general catalog
Safety-compliant positioner type		ACON-CG-10①-NP-2-0						
Pulse-train input type (Differential line driver)		ACON-PL-10①-NP-2-0	Pulse-train input type with differential line driver support	(-)		(Power-saving specification) Rated: 1.3A Maximum: 2.5A	-	
Pulse-train input type (Open collector)		ACON-PO-10①-NP-2-0	Pulse-train input type with open collector support					
Serial communication type		ACON-SE-10①-N-0-0	Dedicated to serial communication	64 points				
Field network type		RACON-10①	Dedicated to a field network	768 points				
Program control type		ASEL-C-1-10①-NP-2-0	Program operation is supported. Up to two axes can be operated.	1500 points				

* This is for the single-axis ASEL
* Enter the code "LA" in ① when the power-saving specification is specified.



- Mini Slider type
- Mini Rod type
- Mini Table type
- Mini Linear type
- Controller
- Fixed Nut
- Tapped Hole
- Single-Guide
- Double-Guide
- Slide Unit

RCA2-RN4NA

ROBO Cylinder Mini Rod Type Short-Length Nut Mounting Type Actuator Width 34 mm 24V Servo Motor Ball Screw Specification/Lead Screw Specification

Model Description	RCA2 — RN4NA — I — 20 — <input type="text"/> — <input type="text"/> — <input type="text"/> — <input type="text"/> — <input type="text"/>							
Series	Type	Encoder type	Motor type	Lead	Stroke	Compatible controllers	Cable length	Option
		I: Incremental specification * Model number is "I" when used with simple absolute unit.	20: Servo motor 20W	6: Ball screw 6mm 4: Ball screw 4mm 2: Ball screw 2mm 6S: Lead screw 6mm 4S: Lead screw 4mm 2S: Lead screw 2mm	30: 30mm 50: 50mm	A1: ACON RACON ASEL A3: AMEC ASEP	N: None P: 1 m S: 3 m M: 5 m X□□: Length Designation	K2: Connector cable exits from the front LA: Power-saving specification

* See page 14 for details on the model descriptions.

Power-saving specification

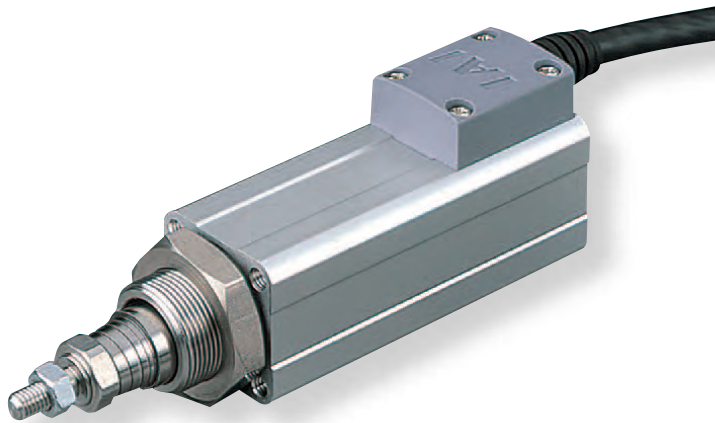

- POINT**
Notes on selection
- (1) The lead screw is not equipped with an anti-rotation device, so please attach a guide or similar locking device to the tip of the lead screw prior to use. (If there is no anti-rotation device attached, the lead screw cannot extend or retract.) When connecting the anti-rotation device and rod, do not use a floating joint.
 - (2) The horizontal payload is the value when the actuator uses an external guide.
 - (3) The payload is the value when the actuator is operated at an acceleration of 0.3 G (0.2G for lead 2, if used vertically and for lead screw specification). The acceleration limit is the value indicated above.
 - (4) Do not apply an external force on the rod in any direction other than the direction the rod is moving in.
 - (5) If the actuator is used vertically, pay attention to rod contact because the rod will come down when the power is turned off.

Actuator Specifications Table

Leads and Payloads

Model	Motor output (W)	Feed screw	Lead (mm)	Maximum payload		Rated thrust (N)	Positioning repeatability (mm)	Stroke (mm)
				Horizontal (kg)	Vertical (kg)			
RCA2-RN4NA-I-20-6-①-②-③-④	20	Ball screw	6	2	0.5	33.8	±0.02	30 50
RCA2-RN4NA-I-20-4-①-②-③-④			4	3	0.75	50.7		
RCA2-RN4NA-I-20-2-①-②-③-④			2	6	1.5	101.5		
RCA2-RN4NA-I-20-6S-①-②-③-④	20	Lead screw	6	0.25	0.125	19.9	±0.05	30 50
RCA2-RN4NA-I-20-4S-①-②-③-④			4	0.5	0.25	29.8		
RCA2-RN4NA-I-20-2S-①-②-③-④			2	1	0.5	59.7		

Legend ① Stroke ② Compatible Controllers ③ Cable length ④ Option

Stroke and Maximum Speed

Lead	Stroke	30 (mm)		50 (mm)	
		30	50	30	50
Ball screw	6	270	<220>	300	
	4	200			
	5	100			
Lead screw	6	220		300	
	4	200			
	2	100			

* <> Indicates Vertical Use

(unit: mm/s)

① Stroke list

Stroke (mm)	Standard price	
	Ball screw	Lead screw
30	—	—
50	—	—

④ Options

Title	Option code	See page	Standard price
Connector cable exits from the front	K2	—	—
Power-saving specification	LA	—	—

③ Cable Length

Type	Cable symbol	Standard price
Standard type (Robot cable)	P (1m)	—
	S (3m)	—
	M (5m)	—
Special length	X06 (6m) ~ X10 (10m)	—
	X11 (11m) ~ X15 (15m)	—
	X16 (16m) ~ X20 (20m)	—
		—

* The standard cable for the RCA2 is the robot cable.

Actuator Specifications

Item	Description
Drive System	Ball screw/Lead screw, ø6mm, rolled C10
Lost motion	Ball screw: 0.1mm or less Lead screw: 0.3 mm or less
Frame	Material: Aluminum, white alumite treated
Ambient operating temperature, humidity	0 to 40°C, 85% RH or less (Non-condensing)
Service life	Lead screw specification Horizontal specification: 10 million cycles, Vertical specification: 5 million cycles

Dimensional Drawings

- *1 Connect the motor and encoder cables.
- *2 During home return, be careful to avoid interference from peripheral objects because the rod travels until the mechanical end.
- *3 The orientation of the nut varies depending on the product.

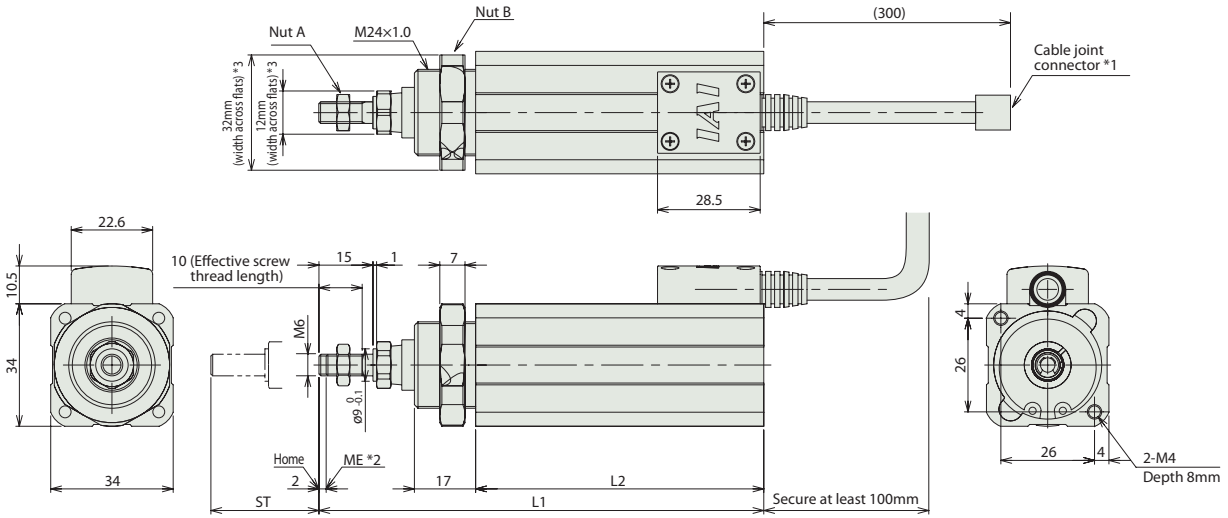

ST : Stroke
ME : Mechanical end

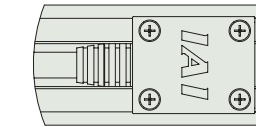
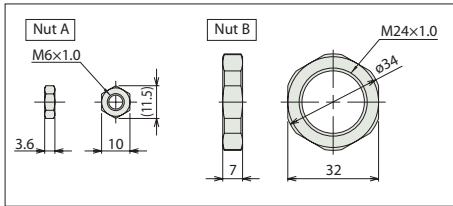

Changing the cable connector outlet direction
Model : K2
(Exits from the front)
* Rotate 180° relative to the standard specification.

■ Dimensions and Weight by Stroke

Stroke	30	50
L1	123.5	143.5
L2	80	100
Mass (kg)	0.4	0.44

② Compatible Controllers

RCA2 series actuators can be operated with the controllers indicated below. Select the type according to your intended application.

Title	External View	Model	Features	Maximum number of positioning points	Input power	Power-supply capacity	Standard price	Reference Page
Solenoid valve type		AMEC-C-20①-NP-2-1	Easy-to-use controller, even for beginners	3 points	AC100V	Rated: 2.4A	-	→ P131
		ASEP-C-20①-NP-2-0	Operable with the same signal as a solenoid valve. Supports both single and double solenoid types. No homing necessary with the simple absolute type.					→ P141
Splash-proof solenoid valve type		ASEP-CW-20①-NP-2-0						
Positioner type		ACON-C-20①-NP-2-0	Up to 512 positioning points are supported.	512 points	DC24V	(Standard specification) Rated: 1.3A Maximum: 4.4 A	-	See the ROBO Cylinder general catalog
Safety-compliant positioner type		ACON-CG-20①-NP-2-0						
Pulse-train input type (Differential line driver)		ACON-PL-20①-NP-2-0	Pulse-train input type with differential line driver support	(-)		(Power-saving specification) Rated: 1.3A Maximum: 2.5A	-	
Pulse-train input type (Open collector)		ACON-PO-20①-NP-2-0	Pulse-train input type with open collector support					
Serial communication type		ACON-SE-20①-N-0-0	Dedicated to serial communication	64 points				
Field network type		RACON-20①	Dedicated to a field network	768 points				
Program control type		ASEL-C-1-20①-NP-2-0	Program operation is supported. Up to two axes can be operated.	1500 points				

* This is for the single-axis ASEL
* Enter the code "LA" in ① when the power-saving specification is specified.

RCS2-RN5N

ROBO Cylinder Mini Rod Type Short-Length Tapped-Hole Mounting Type Actuator Width 46 mm
200V Servo Motor Ball Screw Specification

Model Description	RCS2 — RN5N — I — 60 — <input type="checkbox"/> — <input type="checkbox"/> — T2 — <input type="checkbox"/> — <input type="checkbox"/>							
Series	Type	Encoder type	Motor type	Lead	Stroke	Compatible controllers	Cable length	Option
I: Incremental specification	60: Servo motor 60W	10: 10mm 5: 5mm 2.5: 2.5mm	50: 50mm 75: 75mm	T2: SCON-CA SSEL XSEL-P/Q	N: None P: 1 m S: 3 m M: 5 m X□□: Length Designation R□□: Robot cable	K1: Connector cable exits from the left K2: Connector cable exits from the front K3: Connector cable exits from the right		

* See page 14 for details on the model descriptions.

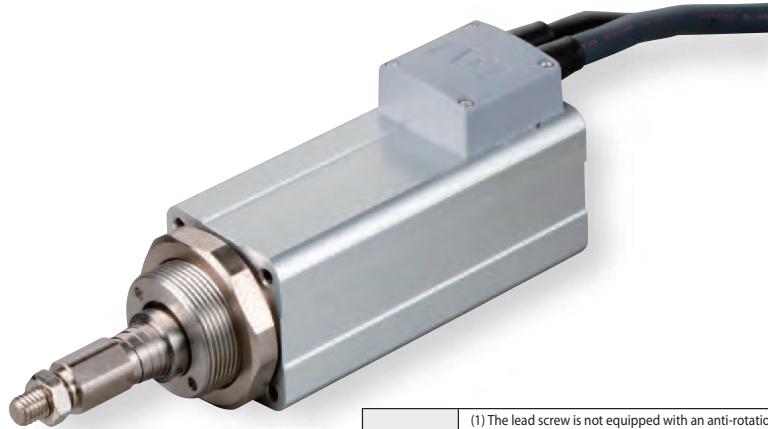

- POINT**
Notes on selection
- (1) The lead screw is not equipped with an anti-rotation device, so please attach a guide or similar locking device to the tip of the lead screw prior to use. (If there is no anti-rotation device attached, the lead screw cannot extend or retract.) When connecting the anti-rotation device and rod, do not use a floating joint.
 - (2) The horizontal payload is the value when the actuator uses an external guide.
 - (3) The payload is the value when the actuator is operated at an acceleration of 0.3 G (0.2G for lead 2.5) horizontally and 0.2G vertically. The acceleration limit is the value indicated above.
 - (4) Do not apply an external force on the rod in any direction other than the direction the rod is moving in.
 - (5) If the actuator is used vertically, pay attention to rod contact because the rod will come down when the power is turned off.

Actuator Specifications Table

Leads and Payloads

Model	Motor output (W)	Feed screw	Lead (mm)	Maximum payload		Rated thrust (N)	Positioning repeatability (mm)	Stroke (mm)
				Horizontal (kg)	Vertical (kg)			
RCS2-RN5N-I-60-10-①-T2-②-③	60	Ball screw	10	5	1.5	89	±0.02	50 75
RCS2-RN5N-I-60-5-①-T2-②-③			5	10	3	178		
RCS2-RN5N-I-60-2.5-①-T2-②-③			2.5	20	6	356		

Legend ① Stroke ② Cable length ③ Option

Stroke and Maximum Speed

Lead	Stroke	50 (mm)	75 (mm)
	10	280 <230>	380 <330>
5	250 <230>	250	
2.5	125		

* < > Indicates vertical use (unit: mm/s)

① Stroke list

Stroke (mm)	Standard price	
50	—	—
75	—	—

② Cable Length

Type	Cable symbol	Standard price
Standard type	P (1m)	—
	S (3m)	—
	M (5m)	—
Special length	X06 (6m) ~ X10 (10m)	—
	X11 (11m) ~ X15 (15m)	—
	X16 (16m) ~ X20 (20m)	—
Robot cable	R01 (1m) ~ R03 (3m)	—
	R04 (4m) ~ R05 (5m)	—
	R06 (6m) ~ R10 (10m)	—
	R11 (11m) ~ R15 (15m)	—
	R16 (16m) ~ R20 (20m)	—
	R16 (16m) ~ R20 (20m)	—

③ Options

Title	Option code	See page	Standard price
Connector cable exits from the left	K1	Refer to the next page	—
Connector cable exits from the front	K2	Refer to the next page	—
Connector cable exits from the right	K3	Refer to the next page	—

Actuator Specifications

Item	Description
Drive System	Ball screw, ø8mm, rolled C10
Lost motion	0.1mm or less
Frame	Material: Aluminum, white alumite treated
Ambient operating temperature, humidity	0 to 40°C, 85% RH or less (Non-condensing)
Service life	5,000 km or 50 million cycles

45

RCS2-RN5N

Dimensional Drawings

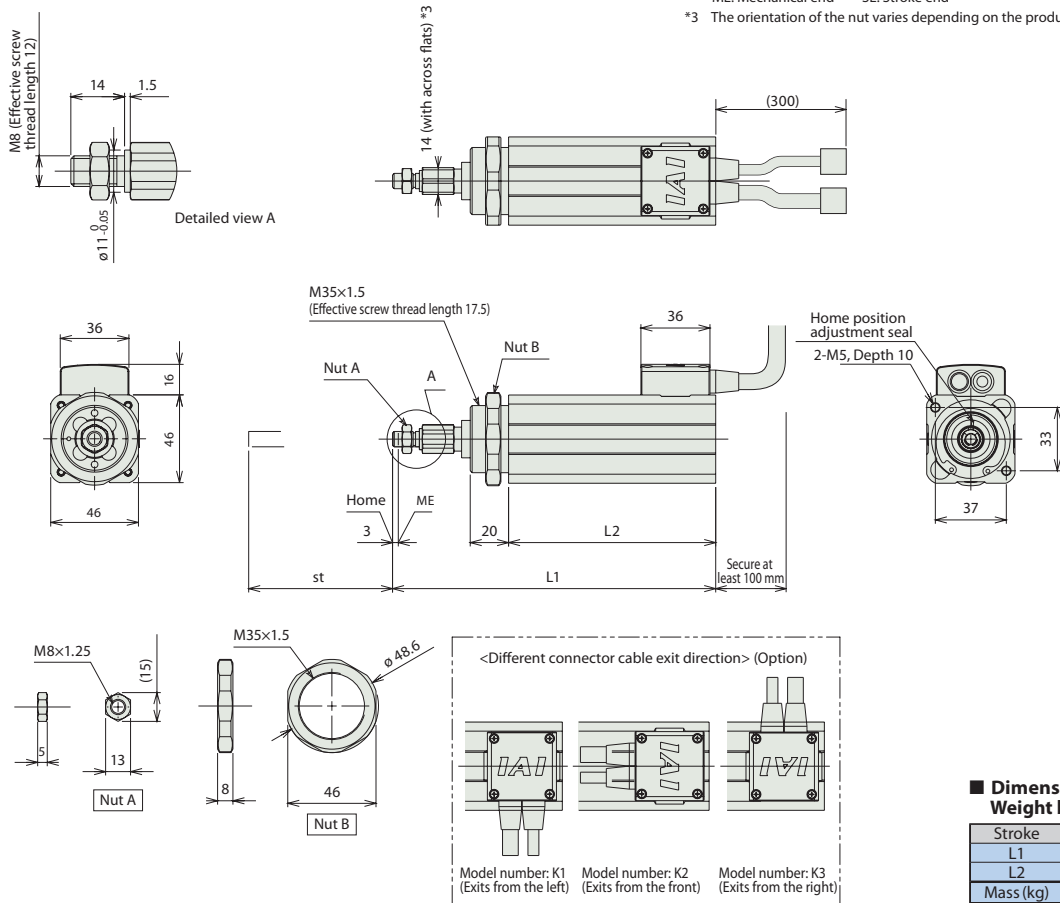

- *1 Connect the motor and encoder cables.
- *2 During home return, be careful to avoid interference from peripheral objects because the rod travels until the mechanical end.
ME: Mechanical end SE: Stroke end
- *3 The orientation of the nut varies depending on the product.

- Mini Slider type
- Mini Rod type
- Mini Table type
- Mini Linear Servo type
- Controller
- Fixed Nut
- Tapped Hole
- Single-Guide
- Double-Guide
- Slide Unit

Compatible Controllers

RCS2 series actuators can be operated with the controllers indicated below. Select the type according to your intended application.

Title	External View	Model	Features	Maximum number of positioning points	Input power	Power-supply capacity	Standard price	Reference Page
Positioner mode		SCON-CA-60I-NP-2-①	Up to 512 positioning points are supported.	512 points	Single-phase 100 VAC Single-phase 200 VAC 3-phase 200 VAC (XSEL-P/Q only)	218 VA max. *Varies depending on the controller. Refer to the operation manual for details.	-	→ P157
Solenoid mode			Can be operated with the same controls used for solenoid valves.	7 points				
Pulse-train input control mode			Can be controlled using pulse trains.	(-)				
Network mode			Can be moved by direct numerical specification.	768 points				
Program control type, 1 or 2 axes		SSEL-C-1-60I-NP-2-①	Program operation is supported. Up to two axes can be operated.	20000 points				See the ROBO Cylinder general catalog
Program control type, 1 to 6 axes		XSEL-①-1-60I-N1-EEE-2-3	Program operation is supported. Up to six axes can be operated.	20000 points				

* The values of SSEL and XSEL assume a 1-axis specification.
 * ① indicates the type of power-supply voltage (1: 100 V/2: Single-phase 200 V).
 * ② indicates the XSEL type (P/Q).

RCA2-RP3NA

ROBO Cylinder Mini Rod Type Short-Length Tapped-Hole Mounting Type Actuator Width 28 mm
24V Servo Motor Ball Screw Specification/Lead Screw Specification

Model Description	RCA2 — RP3NA — I — 10 — [] — [] — [] — [] — []
Series	Type Encoder type Motor type Lead Stroke Compatible controllers Cable length Option
	I: Incremental specification * Model number is "I" when used with simple absolute unit.
	10: Servo motor 10W
	4: Ball screw 4mm 2: Ball screw 2mm 1: Ball screw 1mm 4S: Lead screw 4mm 2S: Lead screw 2mm 1S: Lead screw 1mm
	30: 30mm 50: 50mm
	A1: ACON RACON ASEL A3: AMEC ASEP
	N: None P: 1 m S: 3 m M: 5 m X□□: Length Designation
	K2: Connector cable exits from the front LA: Power-saving specification

* See page 14 for details on the model descriptions.

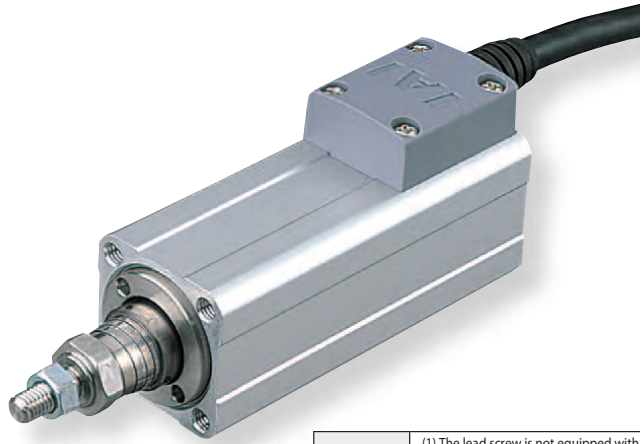

Power-saving specification

- POINT**
Notes on selection
- (1) The lead screw is not equipped with an anti-rotation device, so please attach a guide or similar locking device to the tip of the lead screw prior to use. (If there is no anti-rotation device attached, the lead screw cannot extend or retract.) When connecting the anti-rotation device and rod, do not use a floating joint.
 - (2) The horizontal payload is the value when the actuator uses an external guide.
 - (3) The payload is the value when the actuator is operated at an acceleration of 0.3 G (0.2G for lead 1, if used vertically and for lead screw specification). The acceleration limit is the value indicated above.
 - (4) Do not apply an external force on the rod in any direction other than the direction the rod is moving in.
 - (5) If the actuator is used vertically, pay attention to rod contact because the rod will come down when the power is turned off.

Actuator Specifications Table

Leads and Payloads

Model	Motor output (W)	Feed screw	Lead (mm)	Maximum payload		Rated thrust (N)	Positioning repeatability (mm)	Stroke (mm)
				Horizontal (kg)	Vertical (kg)			
RCA2-RP3NA-I-10-4-①-②-③-④	10	Ball screw	4	0.75	0.25	42.7	±0.02	30 50
RCA2-RP3NA-I-10-2-①-②-③-④			2	1.5	0.5	85.5		
RCA2-RP3NA-I-10-1-①-②-③-④			1	3	1	170.9		
RCA2-RP3NA-I-10-4S-①-②-③-④	10	Lead screw	4	0.25	0.125	25.1	±0.05	30 50
RCA2-RP3NA-I-10-2S-①-②-③-④			2	0.5	0.25	50.3		
RCA2-RP3NA-I-10-1S-①-②-③-④			1	1	0.5	100.5		

Legend ① Stroke ② Compatible Controllers ③ Cable length ④ Option

Stroke and Maximum Speed

Lead	Stroke	Maximum Speed	
		30 (mm)	50 (mm)
Ball screw	4	200	
	2	100	
	1	50	
Lead screw	4	200	
	2	100	
	1	50	

(unit: mm/s)

① Stroke list

Stroke (mm)	Standard price	
	Ball screw	Lead screw
30	—	—
50	—	—

④ Options

Title	Option code	See page	Standard price
Connector cable exits from the front	K2	—	—
Power-saving specification	LA	—	—

③ Cable Length

Type	Cable symbol	Standard price
Standard type (Robot cable)	P (1m)	—
	S (3m)	—
	M (5m)	—
Special length	X06 (6m) ~ X10 (10m)	—
	X11 (11m) ~ X15 (15m)	—
	X16 (16m) ~ X20 (20m)	—
		—

* The standard cable for the RCA2 is the robot cable.

Actuator Specifications

Item	Description
Drive System	Ball screw/Lead screw, ø4mm, rolled C10
Lost motion	Ball screw: 0.1mm or less Lead screw: 0.3 mm or less
Frame	Material: Aluminum, white alumite treated
Ambient operating temperature, humidity	0 to 40°C, 85% RH or less (Non-condensing)
Service life	Lead screw specification Horizontal specification: 10 million cycles, Vertical specification: 5 million cycles

Dimensional Drawings

- *1 Connect the motor and encoder cables.
- *2 During home return, be careful to avoid interference from peripheral objects because the rod travels until the mechanical end.
- *3 The orientation of the nut varies depending on the product.

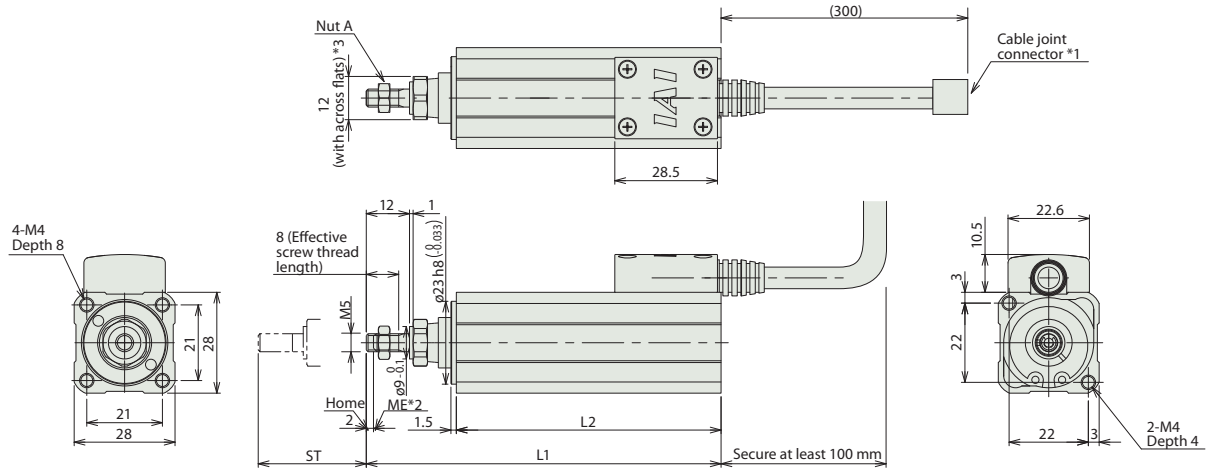

ST : Stroke
ME : Mechanical end

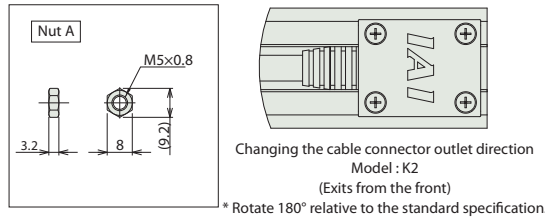

■ Dimensions and Weight by Stroke

Stroke	30	50
L1	98.5	118.5
L2	73.5	93.5
Mass (kg)	0.2	0.22

② Compatible Controllers

RCA2 series actuators can be operated with the controllers indicated below. Select the type according to your intended application.

Title	External View	Model	Features	Maximum number of positioning points	Input power	Power-supply capacity	Standard price	Reference Page
Solenoid valve type		AMEC-C-10①-NP-2-1	Easy-to-use controller, even for beginners	3 points	AC100V	Rated: 2.4A	-	→ P131
Splash-proof solenoid valve type		ASEP-C-10①-NP-2-0	Operable with the same signal as a solenoid valve. Supports both single and double solenoid types. No homing necessary with the simple absolute type.					
Positioner type		ACON-C-10①-NP-2-0	Up to 512 positioning points are supported.	512 points	DC24V	(Standard specification) Rated: 1.3A Maximum: 4.4 A	-	See the ROBO Cylinder general catalog
Safety-compliant positioner type		ACON-CG-10①-NP-2-0						
Pulse-train input type (Differential line driver)		ACON-PL-10①-NP-2-0	Pulse-train input type with differential line driver support	(-)	(Power-saving specification) Rated: 1.3A Maximum: 2.5A	-	-	
Pulse-train input type (Open collector)		ACON-PO-10①-NP-2-0	Pulse-train input type with open collector support					
Serial communication type		ACON-SE-10①-N-0-0	Dedicated to serial communication	64 points				
Field network type		RACON-10①	Dedicated to a field network	768 points				
Program control type		ASEL-C-1-10①-NP-2-0	Program operation is supported. Up to two axes can be operated.	1500 points				

* This is for the single-axis ASEL
* Enter the code "LA" in ① when the power-saving specification is specified.

- Mini Slider type
- Mini Rod type
- Mini Table type
- Mini Linear Servo type
- Controller
- Fixed Nut
- Tapped Hole
- Single-Guide
- Double-Guide
- Slide Unit

RCA2-RP4NA

ROBO Cylinder Mini Rod Type Short-Length Tapped-Hole Mounting Type Actuator Width 34 mm
24V Servo Motor Ball Screw Specification/ Lead Screw Specification

Model Description	RCA2 — RP4NA — I — 20							
Series	Type	Encoder type	Motor type	Lead	Stroke	Compatible controllers	Cable length	Option
		I: Incremental specification * Model number is "I" when used with simple absolute unit.	20: Servo motor 20W	6: Ball screw 6mm 4: Ball screw 4mm 2: Ball screw 2mm 6S: Lead screw 6mm 4S: Lead screw 4mm 2S: Lead screw 2mm	30: 30mm 50: 50mm	A1: ACON RACON ASEL A3: AMEC ASEP	N: None P: 1 m S: 3 m M: 5 m X□□: Length Designation	K2: Connector cable exits from the front LA: Power-saving specification

* See page 14 for details on the model descriptions.

Power-saving specification

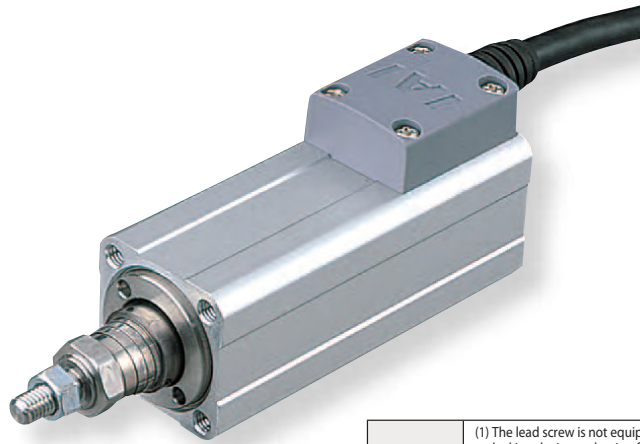

- POINT**
Notes on selection
- (1) The lead screw is not equipped with an anti-rotation device, so please attach a guide or similar locking device to the tip of the lead screw prior to use. (If there is no anti-rotation device attached, the lead screw cannot extend or retract.) When connecting the anti-rotation device and rod, do not use a floating joint.
 - (2) The horizontal payload is the value when the actuator uses an external guide.
 - (3) The payload is the value when the actuator is operated at an acceleration of 0.3 G (0.2G for lead 2 if used vertically and for lead screw specification). The acceleration limit is the value indicated above.
 - (4) Do not apply an external force on the rod in any direction other than the direction the rod is moving in.
 - (5) If the actuator is used vertically, pay attention to rod contact because the rod will come down when the power is turned off.

Actuator Specifications Table

Leads and Payloads

Model	Motor output (W)	Feed screw	Lead (mm)	Maximum payload		Rated thrust (N)	Positioning repeatability (mm)	Stroke (mm)
				Horizontal (kg)	Vertical (kg)			
RCA2-RP4NA-I-20-6-①-②-③-④	20	Ball screw	6	2	0.5	33.8	±0.02	30 50
RCA2-RP4NA-I-20-4-①-②-③-④			4	3	0.75	50.7		
RCA2-RP4NA-I-20-2-①-②-③-④			2	6	1.5	101.5		
RCA2-RP4NA-I-20-6S-①-②-③-④	20	Lead screw	6	0.25	0.125	19.9	±0.05	30 50
RCA2-RP4NA-I-20-4S-①-②-③-④			4	0.5	0.25	29.8		
RCA2-RP4NA-I-20-2S-①-②-③-④			2	1	0.5	59.7		

Legend ① Stroke ② Compatible Controllers ③ Cable length ④ Option

Stroke and Maximum Speed

Lead	Stroke	30 (mm)		50 (mm)	
		Ball screw	Lead screw	Ball screw	Lead screw
Ball screw	6	270	<220>	300	
	4	200			
	2	100			
Lead screw	6	220		300	
	4	200			
	2	100			

* <> Indicates vertical use (unit: mm/s)

① Stroke list

Stroke (mm)	Standard price	
	Ball screw	Lead screw
30	—	—
50	—	—

④ Options

Title	Option code	See page	Standard price
Connector cable exits from the front	K2	—	—
Power-saving specification	LA	—	—

③ Cable Length

Type	Cable symbol	Standard price
Standard type (Robot cable)	P (1m)	—
	S (3m)	—
	M (5m)	—
Special length	X06 (6m) ~ X10 (10m)	—
	X11 (11m) ~ X15 (15m)	—
	X16 (16m) ~ X20 (20m)	—
		—

* The standard cable for the RCA2 is the robot cable.

Actuator Specifications

Item	Description
Drive System	Ball screw/Lead screw, ø6mm, rolled C10
Lost motion	Ball screw: 0.1mm or less Lead screw: 0.3 mm or less
Frame	Material: Aluminum, white alumite treated
Ambient operating temperature, humidity	0 to 40°C, 85% RH or less (Non-condensing)
Service life	Lead screw specification Horizontal specification: 10 million cycles, Vertical specification: 5 million cycles

Dimensional Drawings

- *1 Connect the motor and encoder cables.
- *2 During home return, be careful to avoid interference from peripheral objects because the rod travels until the mechanical end.
- *3 The orientation of the nut varies depending on the product.

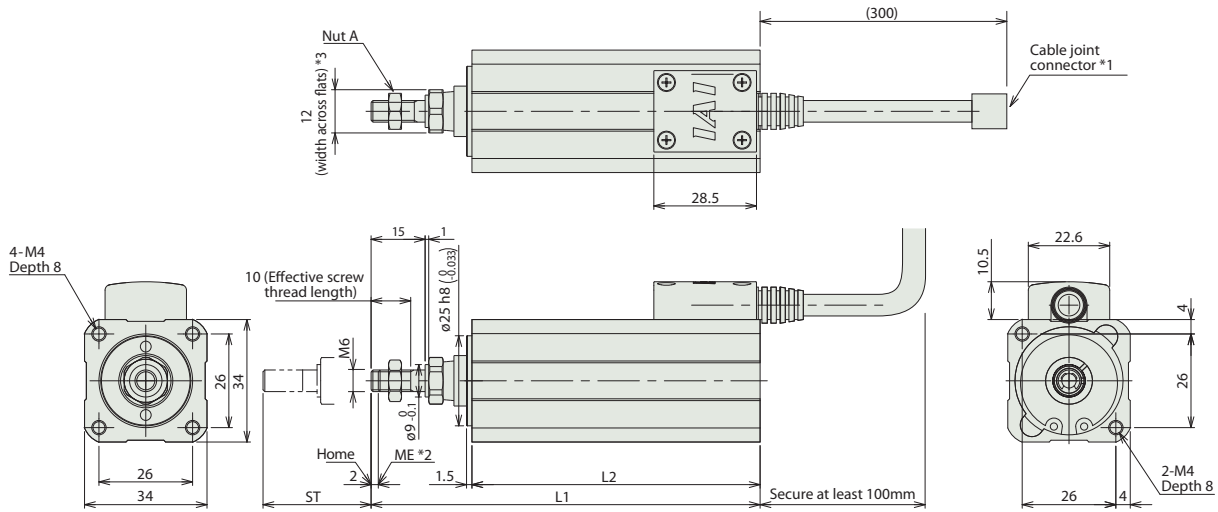

ST : Stroke
ME : Mechanical end

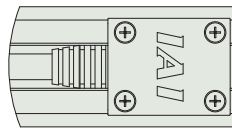
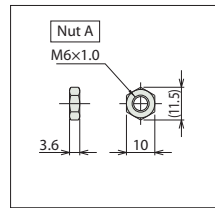

Changing the cable connector outlet direction
Model : K2
(Exits from the front)

■ Dimensions and Weight by Stroke

Stroke	30	50
L1	108	128
L2	80	100
Mass (kg)	0.32	0.36

② Compatible Controllers

RCA2 series actuators can be operated with the controllers indicated below. Select the type according to your intended application.

Title	External View	Model	Features	Maximum number of positioning points	Input power	Power-supply capacity	Standard price	Reference Page
Solenoid valve type		AMEC-C-20I①-NP-2-1	Easy-to-use controller, even for beginners	3 points	AC100V	Rated: 2.4A	-	→ P131
		ASEP-C-20I①-NP-2-0	Operable with the same signal as a solenoid valve. Supports both single and double solenoid types. No homing necessary with the simple absolute type.					→ P141
Splash-proof solenoid valve type		ASEP-CW-20I①-NP-2-0						
Positioner type		ACON-C-20I①-NP-2-0	Up to 512 positioning points are supported.	512 points	DC24V	(Standard specification) Rated: 1.3A Maximum: 4.4 A	-	See the ROBO Cylinder general catalog
Safety-compliant positioner type		ACON-CG-20I①-NP-2-0						
Pulse-train input type (Differential line driver)		ACON-PL-20I①-NP-2-0	Pulse-train input type with differential line driver support	(-)	DC24V	(Power-saving specification) Rated: 1.3A Maximum: 2.5A	-	See the ROBO Cylinder general catalog
Pulse-train input type (Open collector)		ACON-PO-20I①-NP-2-0	Pulse-train input type with open collector support					
Serial communication type		ACON-SE-20I①-N-0-0	Dedicated to serial communication	64 points				
Field network type		RACON-20I①	Dedicated to a field network	768 points				
Program control type		ASEL-C-1-20I①-NP-2-0	Program operation is supported. Up to two axes can be operated.	1500 points				

* This is for the single-axis ASEL
* Enter the code "LA" in ① when the power-saving specification is specified.

RCS2-RP5N

ROBO Cylinder Mini Rod Type Short-Length Tapped-Hole Mounting Type Actuator Width 46 mm
200V Servo Motor Ball Screw Specification

Model Description	RCS2 — RP5N — I — 60 — <input type="checkbox"/> — <input type="checkbox"/> — T2 — <input type="checkbox"/> — <input type="checkbox"/>							
Series	Type	Encoder type	Motor type	Lead	Stroke	Compatible controllers	Cable length	Option
		I: Incremental specification	60: Servo motor 60W	10: 10mm 5: 5mm 2.5: 2.5mm	50: 50mm 75: 75mm	T2: SCON-CA SSEL XSEL-P/Q	N: None P: 1 m S: 3 m M: 5 m X <input type="checkbox"/> : Length Designation R <input type="checkbox"/> : Robot cable	K1: Connector cable exits from the left K2: Connector cable exits from the front K3: Connector cable exits from the right

* See page 14 for details on the model descriptions.

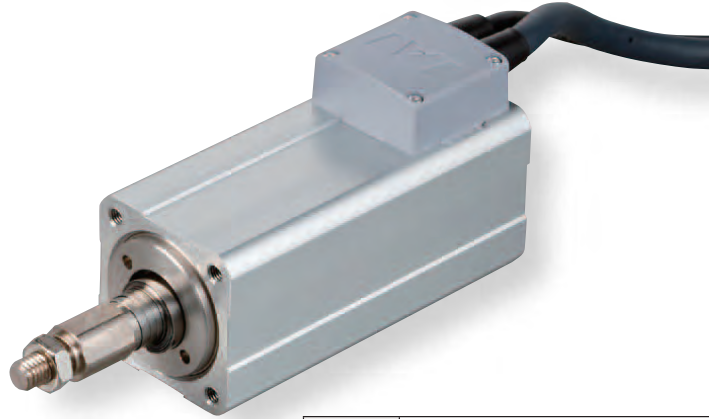

- POINT**
Notes on selection
- (1) The lead screw is not equipped with an anti-rotation device, so please attach a guide or similar locking device to the tip of the lead screw prior to use. (If there is no anti-rotation device attached, the lead screw cannot extend or retract.) When connecting the anti-rotation device and rod, do not use a floating joint.
 - (2) The horizontal payload is the value when the actuator uses an external guide.
 - (3) The payload is the value when the actuator is operated at an acceleration of 0.3 G (0.2G for lead 2.5) horizontally and 0.2G vertically. The acceleration limit is the value indicated above.
 - (4) Do not apply an external force on the rod in any direction other than the direction the rod is moving in.
 - (5) If the actuator is used vertically, pay attention to rod contact because the rod will come down when the power is turned off.

Actuator Specifications Table

Leads and Payloads

Model	Motor output (W)	Feed screw	Lead (mm)	Maximum payload		Rated thrust (N)	Positioning repeatability (mm)	Stroke (mm)
				Horizontal (kg)	Vertical (kg)			
RCS2-RP5N-I-60-10- <input type="checkbox"/> -T2- <input type="checkbox"/> - <input type="checkbox"/>	60	Ball screw	10	5	1.5	89	±0.02	50 75
RCS2-RP5N-I-60-5- <input type="checkbox"/> -T2- <input type="checkbox"/> - <input type="checkbox"/>			5	10	3	178		
RCS2-RP5N-I-60-2.5- <input type="checkbox"/> -T2- <input type="checkbox"/> - <input type="checkbox"/>			2.5	20	6	356		

Legend Stroke Cable length Option

Stroke and Maximum Speed

Lead	Stroke	50 (mm)	75 (mm)
	10	280 <230>	380 <330>
5	250 <230>	250	
2.5	125		

* < > Indicates vertical use (unit: mm/s)

① Stroke list

Stroke (mm)	Standard price
50	—
75	—

② Cable Length

Type	Cable symbol	Standard price
Standard type	P (1m)	—
	S (3m)	—
	M (5m)	—
Special length	X06 (6m) ~ X10 (10m)	—
	X11 (11m) ~ X15 (15m)	—
	X16 (16m) ~ X20 (20m)	—
Robot cable	R01 (1m) ~ R03 (3m)	—
	R04 (4m) ~ R05 (5m)	—
	R06 (6m) ~ R10 (10m)	—
	R11 (11m) ~ R15 (15m)	—
	R16 (16m) ~ R20 (20m)	—

③ Options

Title	Option code	See page	Standard price
Connector cable exits from the left	K1	Refer to the next page	—
Connector cable exits from the front	K2	Refer to the next page	—
Connector cable exits from the right	K3	Refer to the next page	—

Actuator Specifications

Item	Description
Drive System	Ball screw, ø8mm, rolled C10
Lost motion	0.1mm or less
Frame	Material: Aluminum, white alumite treated
Ambient operating temperature, humidity	0 to 40°C, 85% RH or less (Non-condensing)
Service life	5,000 km or 50 million cycles

Dimensional Drawings

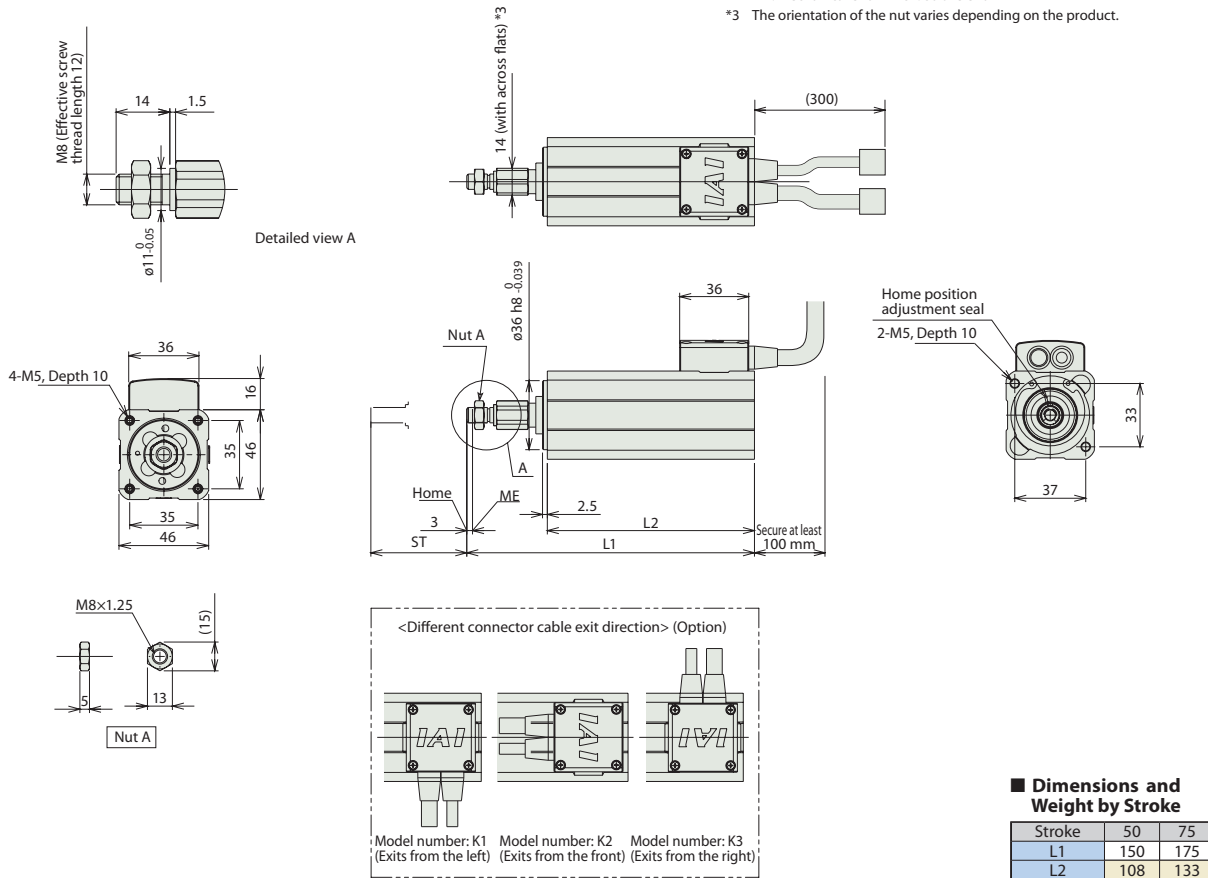

Compatible Controllers

RCS2 series actuators can be operated with the controllers indicated below. Select the type according to your intended application.

Title	External View	Model	Features	Maximum number of positioning points	Input power	Power-supply capacity	Standard price	Reference Page
Positioner mode		SCON-CA-60I-NP-2-①	Up to 512 positioning points are supported.	512 points	Single-phase 100 VAC Single-phase 200 VAC 3-phase 200 VAC (XSEL-P/Q only)	218 VA max. * Varies depending on the controller. Refer to the operation manual for details.	-	→ P157
Solenoid mode			Can be operated with the same controls used for solenoid valves.	7 points				
Pulse-train input control mode			Can be controlled using pulse trains.	(-)				
Network mode			Can be moved by direct numerical specification.	768 points				
Program control type, 1 or 2 axes		SSEL-C-1-60I-NP-2-①	Program operation is supported. Up to two axes can be operated.	20000 points				See the ROBO Cylinder general catalog
Program control type, 1 to 6 axes		XSEL-①-1-60I-N1-EEE-2-3	Program operation is supported. Up to six axes can be operated.	20000 points				

* The values of SSEL and XSEL assume a 1-axis specification.
 * ① indicates the type of power-supply voltage (1: 100 V/2: Single-phase 200 V).
 * ② indicates the XSEL type (P/Q).

- Mini Slider type
- Mini Rod type
- Mini Table type
- Mini Servo type
- Controller
- Fixed Nut
- Tapped Hole
- Single-Guide
- Double-Guide
- Slide Unit

RCA2-GS3NA

ROBO Cylinder Mini Rod Type Short-Length Single-guide Type Actuator Width 28 mm 24V Servo Motor Ball Screw Specification/Lead Screw Specification

Model Description	RCA2 — GS3NA — I — 10 — <input type="text"/> — <input type="text"/> — <input type="text"/> — <input type="text"/> — <input type="text"/>							
Series	Type	Encoder type	Motor type	Lead	Stroke	Compatible controllers	Cable length	Option
I: Incremental specification * Model number is "I" when used with simple absolute unit.	10: Servo motor 10W	4: Ball screw 4mm 2: Ball screw 2mm 1: Ball screw 1mm 4S: Lead screw 4mm 2S: Lead screw 2mm 1S: Lead screw 1mm		30: 30mm 50: 50mm	A1: ACON RACON ASEL A3: AMEC ASEP	N: None P: 1 m S: 3 m M: 5 m X <input type="checkbox"/> : Length Designation	K2: Connector cable exits from the front LA: Power-saving specification	

* See page 14 for details on the model descriptions.

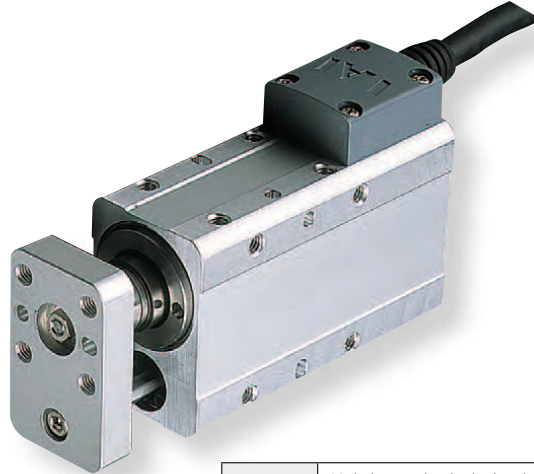

Power-saving specification

POINT
Notes on selection

(1) The horizontal payload is the value when used in combination with a guide so that a radial load and moment load are not applied to the rod. See P129 for correlation diagrams of the end load and service life when a guide is not installed. Also note that single-guide types cannot be used if a force is applied in the rotating direction. See double-guide types in these applications.

(2) The payload is the value when the actuator is operated at an acceleration of 0.3 G (0.2G for lead 1, if used vertically and for lead screw specification). The acceleration limit is the value indicated above.

(3) If the actuator is used vertically, pay attention to rod contact because the rod will come down when the power is turned off.

Actuator Specifications Table

Leads and Payloads

Model	Motor output (W)	Feed screw	Lead (mm)	Maximum payload		Rated thrust (N)	Positioning repeatability (mm)	Stroke (mm)
				Horizontal (kg)	Vertical (kg)			
RCA2-GS3NA-I-10-4-①-②-③-④	10	Ball screw	4	0.75	0.25	42.7	±0.02	30 50
RCA2-GS3NA-I-10-2-①-②-③-④			2	1.5	0.5	85.5		
RCA2-GS3NA-I-10-1-①-②-③-④			1	3	1	170.9		
RCA2-GS3NA-I-10-4S-①-②-③-④	10	Lead screw	4	0.25	0.125	25.1	±0.05	30 50
RCA2-GS3NA-I-10-2S-①-②-③-④			2	0.5	0.25	50.3		
RCA2-GS3NA-I-10-1S-①-②-③-④			1	1	0.5	100.5		

Legend ① Stroke ② Compatible Controllers ③ Cable length ④ Option

Stroke and Maximum Speed

Lead	Stroke	Maximum Speed	
		30 (mm)	50 (mm)
Ball screw	4	200	
	2	100	
	1	50	
Lead screw	4	200	
	2	100	
	1	50	

(unit: mm/s)

① Stroke list

Stroke (mm)	Standard price	
	Ball screw	Lead screw
30	—	—
50	—	—

③ Cable Length

Type	Cable symbol	Standard price
Standard type (Robot cable)	P (1m)	—
	S (3m)	—
	M (5m)	—
Special length	X06 (6m) ~ X10 (10m)	—
	X11 (11m) ~ X15 (15m)	—
	X16 (16m) ~ X20 (20m)	—
	—	—

* The standard cable for the RCA2 is the robot cable.

④ Options

Title	Option code	See page	Standard price
Connector cable exits from the front	K2	—	—
Power-saving specification	LA	—	—

Actuator Specifications

Item	Description
Drive System	Ball screw/Lead screw, ø4mm, rolled C10
Lost motion	Ball screw: 0.1mm or less Lead screw: 0.3 mm or less
Frame	Material: Aluminum, white alumite treated
Ambient operating temperature, humidity	0 to 40°C, 85% RH or less (Non-condensing)
Service life	Lead screw specification Horizontal specification: 10 million cycles, Vertical specification: 5 million cycles

RCA2-GS4NA

ROBO Cylinder Mini Rod Type Short-Length Single-guide Type Actuator Width 34 mm 24V Servo Motor Ball Screw Specification/Lead Screw Specification

Model Description	RCA2 — GS4NA — I — 20 — [] — [] — [] — [] — []							
Series	Type	Encoder type	Motor type	Lead	Stroke	Compatible controllers	Cable length	Option
I: Incremental specification * Model number is "I" when used with simple absolute unit.	20: Servo motor 20W	6: Ball screw 6mm 4: Ball screw 4mm 2: Ball screw 2mm 6S: Lead screw 6mm 4S: Lead screw 4mm 2S: Lead screw 2mm	30: 30mm 50: 50mm	A1: ACON RACON ASEL A3: AMEC ASEP	N: None P: 1 m S: 3 m M: 5 m X□□: Length Designation	K2: Connector cable exits from the front LA: Power-saving specification		

* See page 14 for details on the model descriptions.

Power-saving specification

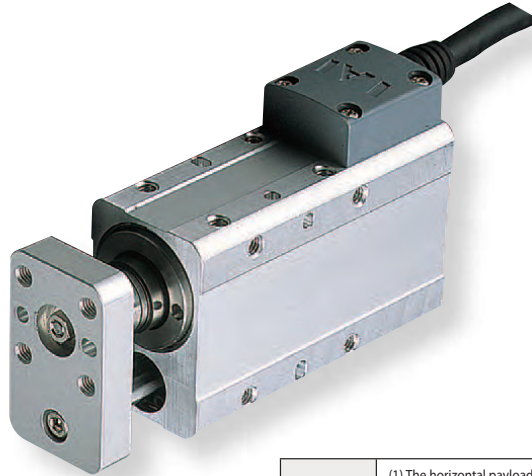

POINT
Notes on selection

(1) The horizontal payload is the value when used in combination with a guide so that a radial load and moment load are not applied to the rod. See P129 for correlation diagrams of the end load and service life when a guide is not installed. Also note that single-guide types cannot be used if a force is applied in the rotating direction. Use double-guide types in these applications.

(2) The payload is the value when the actuator is operated at an acceleration of 0.3 G (0.2G for lead 2, if used vertically and for lead screw specification). The acceleration limit is the value indicated above.

(3) If the actuator is used vertically, pay attention to rod contact because the rod will come down when the power is turned off.

Actuator Specifications Table

Leads and Payloads

Model	Motor output (W)	Feed screw	Lead (mm)	Maximum payload		Rated thrust (N)	Positioning repeatability (mm)	Stroke (mm)
				Horizontal (kg)	Vertical (kg)			
RCA2-GS4NA-I-20-6-①-②-③-④	20	Ball screw	6	2	0.5	33.8	±0.02	30 50
RCA2-GS4NA-I-20-4-①-②-③-④			4	3	0.75	50.7		
RCA2-GS4NA-I-20-2-①-②-③-④			2	6	1.5	101.5		
RCA2-GS4NA-I-20-6S-①-②-③-④	20	Lead screw	6	0.25	0.125	19.9	±0.05	30 50
RCA2-GS4NA-I-20-4S-①-②-③-④			4	0.5	0.25	29.8		
RCA2-GS4NA-I-20-2S-①-②-③-④			2	1	0.5	59.7		

Legend ① Stroke ② Compatible Controllers ③ Cable length ④ Option

Stroke and Maximum Speed

Lead	Stroke	30 (mm)		50 (mm)	
		30 (mm)	50 (mm)	30 (mm)	50 (mm)
Ball screw	6	270	<220>	300	
	4	200			
	2	100			
Lead screw	6	220	300		
	4	200			
	2	100			

* <> Indicates vertical use (unit: mm/s)

① Stroke list

Stroke (mm)	Standard price	
	Ball screw	Lead screw
30	—	—
50	—	—

④ Options

Title	Option code	See page	Standard price
Connector cable exits from the front	K2	—	—
Power-saving specification	LA	—	—

③ Cable Length

Type	Cable symbol	Standard price
Standard type (Robot cable)	P (1m)	—
	S (3m)	—
	M (5m)	—
Special length	X06 (6m) ~ X10 (10m)	—
	X11 (11m) ~ X15 (15m)	—
	X16 (16m) ~ X20 (20m)	—
		—

* The standard cable for the RCA2 is the robot cable.

Actuator Specifications

Item	Description
Drive System	Ball screw/Lead screw, ø6mm, rolled C10
Lost motion	Ball screw: 0.1mm or less Lead screw: 0.3 mm or less
Frame	Material: Aluminum, white alumite treated
Ambient operating temperature, humidity	0 to 40°C, 85% RH or less (Non-condensing)
Service life	Lead screw specification Horizontal specification: 10 million cycles, Vertical specification: 5 million cycles

Dimensional Drawings

- *1 Connect the motor and encoder cables.
- *2 During home return, be careful to avoid interference from peripheral objects because the rod travels until the mechanical end.

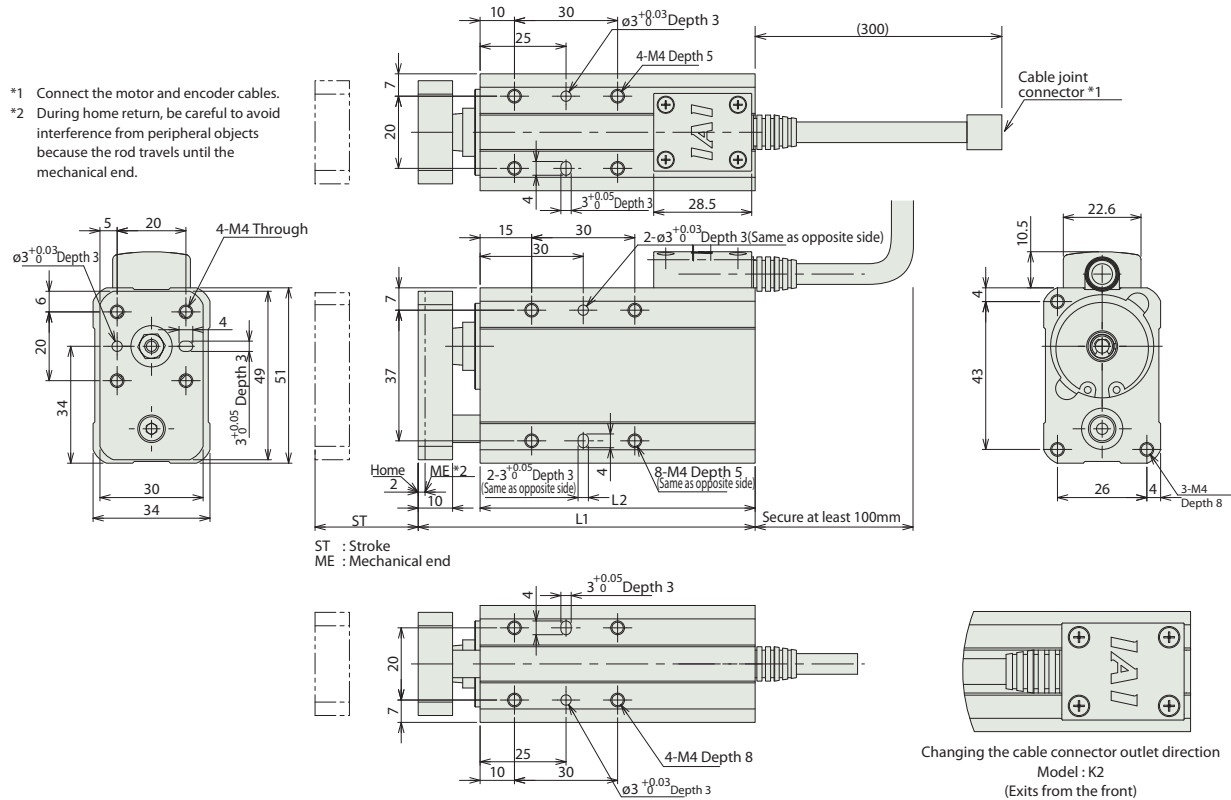

Dimensions and Weight by Stroke

Stroke	30	50
L1	98	118
L2	80	100
Mass (kg)	0.55	0.63

Compatible Controllers

RCA2 series actuators can be operated with the controllers indicated below. Select the type according to your intended application.

Title	External View	Model	Features	Maximum number of positioning points	Input power	Power-supply capacity	Standard price	Reference Page
Solenoid valve type		AMEC-C-20I①-NP-2-1	Easy-to-use controller, even for beginners	3 points	AC100V	Rated: 2.4A	-	→ P131
		ASEP-C-20I①-NP-2-0	Operable with the same signal as a solenoid valve. Supports both single and double solenoid types. No homing necessary with the simple absolute type.					→ P141
Splash-proof solenoid valve type		ASEP-CW-20I①-NP-2-0						
Positioner type		ACON-C-20I①-NP-2-0	Up to 512 positioning points are supported.	512 points	DC24V	(Standard specification) Rated: 1.3A Maximum: 4.4 A	-	See the ROBO Cylinder general catalog
Safety-compliant positioner type		ACON-CG-20I①-NP-2-0						
Pulse-train input type (Differential line driver)		ACON-PL-20I①-NP-2-0	Pulse-train input type with differential line driver support	(-)		(Power-saving specification) Rated: 1.3A Maximum: 2.5A	-	
Pulse-train input type (Open collector)		ACON-PO-20I①-NP-2-0	Pulse-train input type with open collector support					
Serial communication type		ACON-SE-20I①-N-0-0	Dedicated to serial communication	64 points				
Field network type		RACON-20I①	Dedicated to a field network	768 points				
Program control type		ASEL-C-1-20I①-NP-2-0	Program operation is supported. Up to two axes can be operated.	1500 points				

* This is for the single-axis ASEL
* Enter the code "LA" in ① when the power-saving specification is specified.

- Mini Slider type
- Mini Rod type
- Mini Table type
- Mini Linear type
- Controller
- Fixed Nut
- Tapped Hole
- Single-Guide
- Double-Guide
- Slide Unit

RCS2-GS5N

ROBO Cylinder Mini Rod Type Short-Length Single-guide Type Actuator Width 46 mm
200V Servo Motor Ball Screw Specification

Model Description	RCS2 — GS5N — I — 60 — <input type="checkbox"/> — <input type="checkbox"/> — T2 — <input type="checkbox"/> — <input type="checkbox"/>							
Series	Type	Encoder type	Motor type	Lead	Stroke	Compatible controllers	Cable length	Option
I: Incremental specification	60: Servo motor 60W	10: 10mm 5: 5mm 2.5: 2.5mm	50: 50mm 75: 75mm	T2: SCON-CA SSEL XSEL-P/Q	N: None P: 1 m S: 3 m M: 5 m X□□: Length Designation R□□: Robot cable	K1: Connector cable exits from the left K2: Connector cable exits from the front K3: Connector cable exits from the right		

* See page 14 for details on the model descriptions.

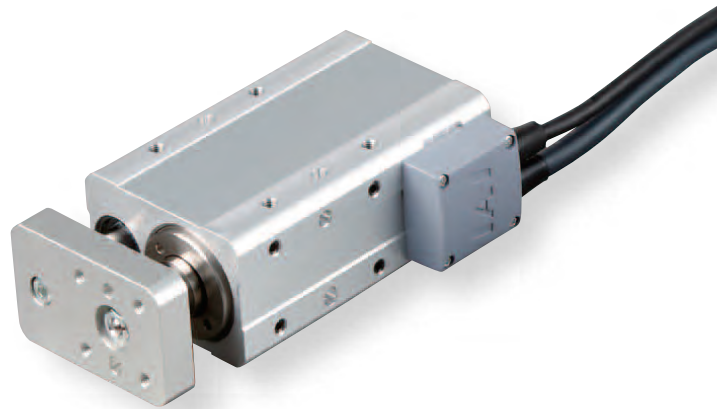

- POINT**
Notes on selection
- (1) The horizontal payload is the value when used in combination with a guide so that a radial load and moment load are not applied to the rod. See P129 for correlation diagrams of the end load and service life when a guide is not installed. Also note that single-guide types cannot be used if a force is applied in the rotating direction. Use double-guide types in these applications.
 - (2) The payload is the value when the actuator is operated at an acceleration of 0.3 G (0.2G for lead 2.5) horizontally and 0.2G vertically. The acceleration limit is the value indicated above.
 - (3) If the actuator is used vertically, pay attention to rod contact because the rod will come down when the power is turned off.

Actuator Specifications Table

Leads and Payloads

Model	Motor output (W)	Feed screw	Lead (mm)	Maximum payload		Rated thrust (N)	Positioning repeatability (mm)	Stroke (mm)
				Horizontal (kg)	Vertical (kg)			
RCS2-GS5N-I-60-10-①-T2-②-③	60	Ball screw	10	5	1.5	89	±0.02	50 75
RCS2-GS5N-I-60-5-①-T2-②-③			5	10	3	178		
RCS2-GS5N-I-60-2.5-①-T2-②-③			2.5	20	6	356		

Legend ① Stroke ② Cable length ③ Option

Stroke and Maximum Speed

Lead	Stroke	50 (mm)	75 (mm)
	10	280 <230>	380 <330>
5	250 <230>	250	
2.5	125		

* < > Indicates vertical use (unit: mm/s)

① Stroke list

Stroke (mm)	Standard price
50	—
75	—

② Cable Length

Type	Cable symbol	Standard price
Standard type	P (1m)	—
	S (3m)	—
	M (5m)	—
Special length	X06 (6m) ~ X10 (10m)	—
	X11 (11m) ~ X15 (15m)	—
	X16 (16m) ~ X20 (20m)	—
Robot cable	R01 (1m) ~ R03 (3m)	—
	R04 (4m) ~ R05 (5m)	—
	R06 (6m) ~ R10 (10m)	—
	R11 (11m) ~ R15 (15m)	—
	R16 (16m) ~ R20 (20m)	—
	R16 (16m) ~ R20 (20m)	—

③ Options

Title	Option code	See page	Standard price
Connector cable exits from the left	K1	Refer to the next page	—
Connector cable exits from the front	K2	Refer to the next page	—
Connector cable exits from the right	K3	Refer to the next page	—

Actuator Specifications

Item	Description
Drive System	Ball screw, ø8mm, rolled C10
Lost motion	0.1mm or less
Frame	Material: Aluminum, white alumite treated
Ambient operating temperature, humidity	0 to 40°C, 85% RH or less (Non-condensing)
Service life	5,000 km or 50 million cycles

Dimensional Drawings

- *1 Connect the motor and encoder cables.
 - *2 During home return, be careful to avoid interference from peripheral objects because the rod travels until the mechanical end.
- ME: Mechanical end SE: Stroke end

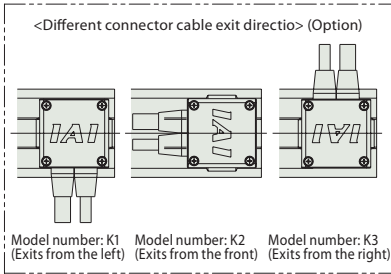
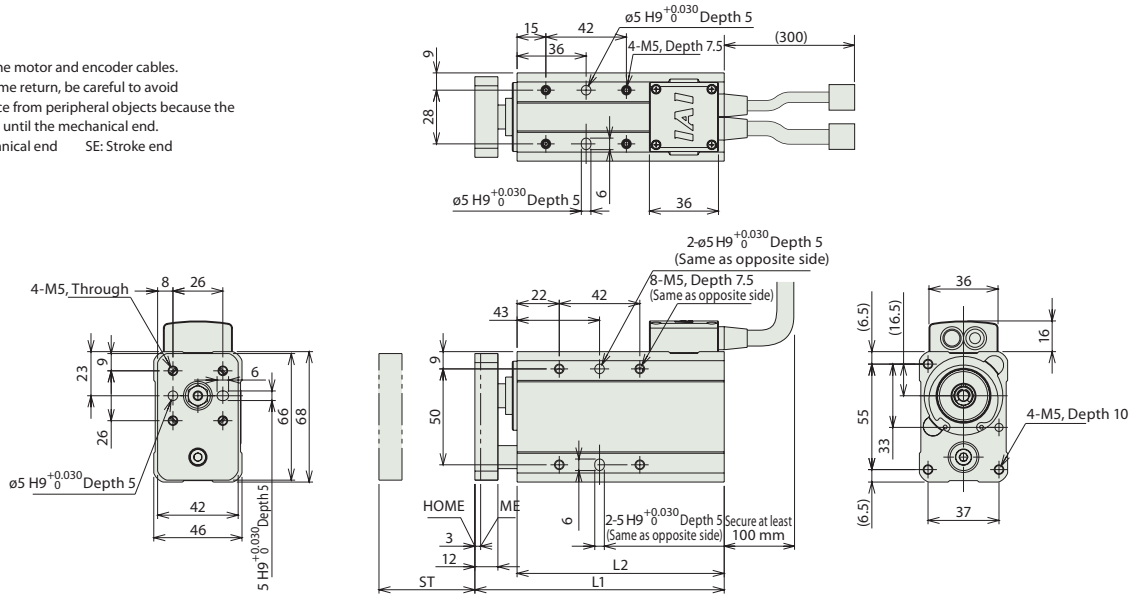

■ Dimensions and Weight by Stroke

Stroke	50	75
L1	130	155
L2	108	133
Mass (kg)	1.3	1.4

Compatible Controllers

RCS2 series actuators can be operated with the controllers indicated below. Select the type according to your intended application.

Title	External View	Model	Features	Maximum number of positioning points	Input power	Power-supply capacity	Standard price	Reference Page
Positioner mode		SCON-CA-60I-NP-2-①	Up to 512 positioning points are supported.	512 points	Single-phase 100 VAC Single-phase 200 VAC 3-phase 200 VAC (XSEL-P/Q only)	218 VA max. *Varies depending on the controller. Refer to the operation manual for details.	-	→ P157
Solenoid mode			Can be operated with the same controls used for solenoid valves.	7 points				
Pulse-train input control mode			Can be controlled using pulse trains.	(-)				
Network mode			Can be moved by direct numerical specification.	768 points				
Program control type, 1 or 2 axes		SSEL-C-1-60I-NP-2-①	Program operation is supported. Up to two axes can be operated.	20000 points			-	See the ROBO Cylinder general catalog
Program control type, 1 to 6 axes		XSEL-①-1-60I-N1-EEE-2-3	Program operation is supported. Up to six axes can be operated.	20000 points			-	

* The values of SSEL and XSEL assume a 1-axis specification.
 * ① indicates the type of power-supply voltage (1: 100 V/2: Single-phase 200 V).
 * ② indicates the XSEL type (P/Q).

- Mini Slider type
- Mini Rod type
- Mini Table type
- Mini Servo Linear type
- Controller
- Fixed Nut
- Tapped Hole
- Single-Guide
- Double-Guide
- Slide Unit

RCA2-GD3NA

ROBO Cylinder Mini Rod Type Short-Length Double-guide Type Actuator Width 28 mm 24V Servo Motor Ball Screw Specification/Lead Screw Specification

Model Description	RCA2 — GD3NA — I — 10 — <input type="checkbox"/> — <input type="checkbox"/> — <input type="checkbox"/> — <input type="checkbox"/> — <input type="checkbox"/>
Series	Type Encoder type Motor type Lead Stroke Compatible controllers Cable length Option
	I: Incremental specification * Model number is "I" when used with simple absolute unit.
	10: Servo motor 10W
	4: Ball screw 4mm 2: Ball screw 2mm 1: Ball screw 1mm 4S: Lead screw 4mm 2S: Lead screw 2mm 1S: Lead screw 1mm
	30: 30mm 50: 50mm
	A1: ACON RACON ASEL A3: AMEC ASEP
	N: None P: 1 m S: 3 m M: 5 m X <input type="checkbox"/> : Length Designation
	K2: Connector cable exits from the front LA: Power-saving specification

* See page 14 for details on the model descriptions.

Power-saving specification

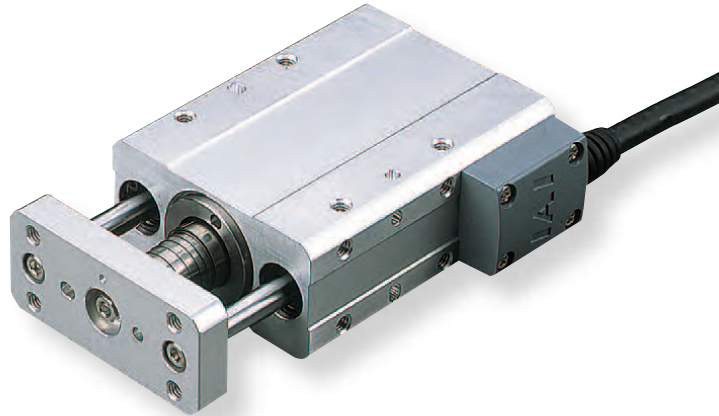

POINT
Notes on selection

- (1) The horizontal payload is the value when used in combination with a guide so that a radial load and moment load are not applied to the rod. See P129 for correlation diagrams of the end load and service life when a guide is not installed.
- (2) The payload is the value when the actuator is operated at an acceleration of 0.3 G (0.2G for lead 1, if used vertically and for lead screw specification). The acceleration limit is the value indicated above.
- (3) If the actuator is used vertically, pay attention to rod contact because the rod will come down when the power is turned off.

Actuator Specifications Table

Leads and Payloads

Model	Motor output (W)	Feed screw	Lead (mm)	Maximum payload		Rated thrust (N)	Positioning repeatability (mm)	Stroke (mm)
				Horizontal (kg)	Vertical (kg)			
RCA2-GD3NA-I-10-4-①-②-③-④	10	Ball screw	4	0.75	0.25	42.7	±0.02	30 50
RCA2-GD3NA-I-10-2-①-②-③-④			2	1.5	0.5	85.5		
RCA2-GD3NA-I-10-1-①-②-③-④			1	3	1	170.9		
RCA2-GD3NA-I-10-4S-①-②-③-④	10	Lead screw	4	0.25	0.125	25.1	±0.05	30 50
RCA2-GD3NA-I-10-2S-①-②-③-④			2	0.5	0.25	50.3		
RCA2-GD3NA-I-10-1S-①-②-③-④			1	1	0.5	100.5		

Legend ① Stroke ② Compatible Controllers ③ Cable length ④ Option

Stroke and Maximum Speed

Lead	Stroke	Maximum Speed	
		30 (mm)	50 (mm)
Ball screw	4	200	
	2	100	
	1	50	
Lead screw	4	200	
	2	100	
	1	50	

(unit: mm/s)

① Stroke list

Stroke (mm)	Standard price	
	Ball screw	Lead screw
30	—	—
50	—	—

③ Cable Length

Type	Cable symbol	Standard price
Standard type (Robot cable)	P (1m)	—
	S (3m)	—
	M (5m)	—
Special length	X06 (6m) ~ X10 (10m)	—
	X11 (11m) ~ X15 (15m)	—
	X16 (16m) ~ X20 (20m)	—
		—

* The standard cable for the RCA2 is the robot cable.

④ Options

Title	Option code	See page	Standard price
Connector cable exits from the front	K2	—	—
Power-saving specification	LA	—	—

Actuator Specifications

Item	Description
Drive System	Ball screw/Lead screw, ø4mm, rolled C10
Lost motion	Ball screw: 0.1mm or less Lead screw: 0.3 mm or less
Frame	Material: Aluminum, white alumite treated
Ambient operating temperature, humidity	0 to 40°C, 85% RH or less (Non-condensing)
Service life	Lead screw specification Horizontal specification: 10 million cycles, Vertical specification: 5 million cycles

Dimensional Drawings

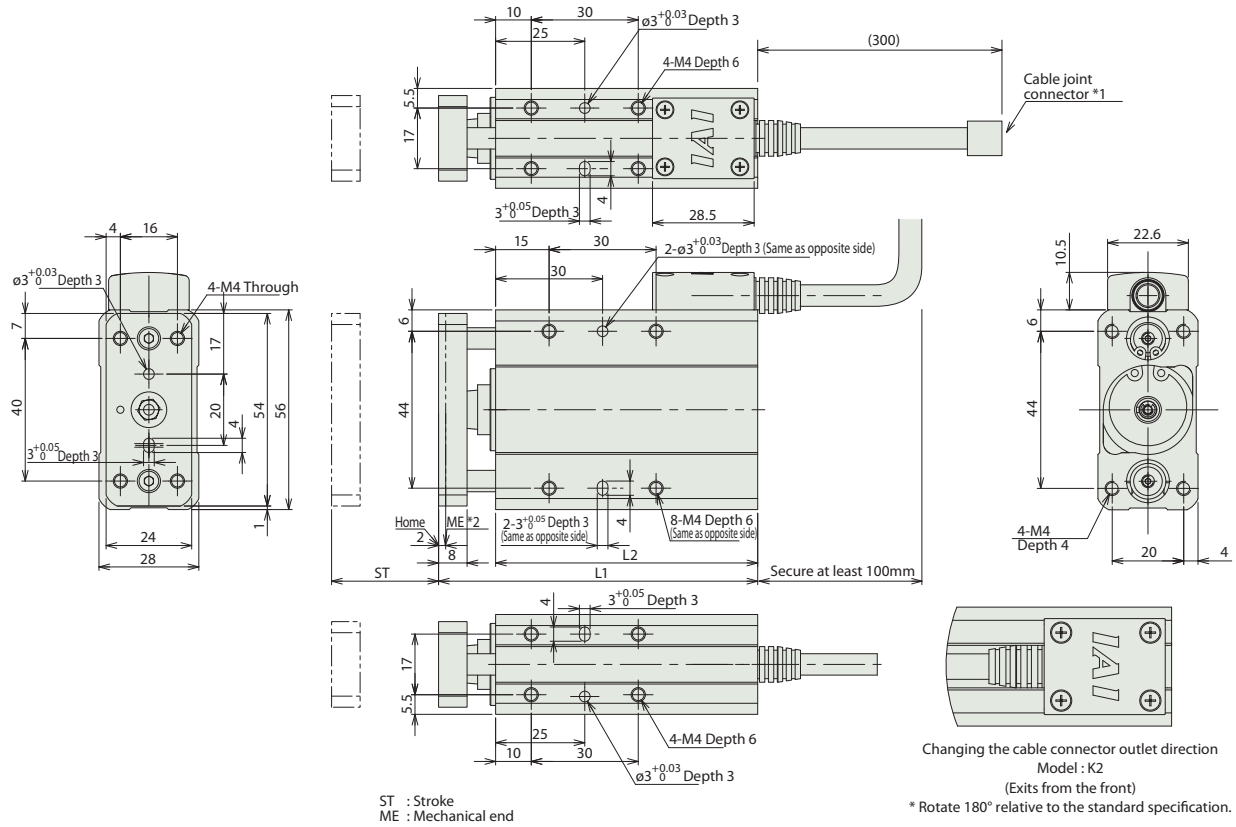

- *1 Connect the motor and encoder cables.
- *2 During home return, be careful to avoid interference from peripheral objects because the rod travels until the mechanical end.

Dimensions and Weight by Stroke

Stroke	30	50
L1	89.5	109.5
L2	73.5	93.5
Mass (kg)	0.41	0.48

Compatible Controllers

RCA2 series actuators can be operated with the controllers indicated below. Select the type according to your intended application.

Title	External View	Model	Features	Maximum number of positioning points	Input power	Power-supply capacity	Standard price	Reference Page
Solenoid valve type		AMEC-C-10①-NP-2-1	Easy-to-use controller, even for beginners	3 points	AC100V	Rated: 2.4A	-	→ P131
Splash-proof solenoid valve type		ASEP-C-10①-NP-2-0	Operable with the same signal as a solenoid valve. Supports both single and double solenoid types. No homing necessary with the simple absolute type.					
Positioner type		ACON-C-10①-NP-2-0	Up to 512 positioning points are supported.	512 points	DC24V	(Standard specification) Rated: 1.3A Maximum: 4.4 A	-	See the ROBO Cylinder general catalog
Safety-compliant positioner type		ACON-CG-10①-NP-2-0						
Pulse-train input type (Differential line driver)		ACON-PL-10①-NP-2-0	Pulse-train input type with differential line driver support	(-)	DC24V	(Power-saving specification) Rated: 1.3A Maximum: 2.5A	-	See the ROBO Cylinder general catalog
Pulse-train input type (Open collector)		ACON-PO-10①-NP-2-0	Pulse-train input type with open collector support					
Serial communication type		ACON-SE-10①-N-0-0	Dedicated to serial communication	64 points	DC24V	(Power-saving specification) Rated: 1.3A Maximum: 2.5A	-	See the ROBO Cylinder general catalog
Field network type		RACON-10①	Dedicated to a field network	768 points	DC24V	(Power-saving specification) Rated: 1.3A Maximum: 2.5A	-	See the ROBO Cylinder general catalog
Program control type		ASEL-C-1-10①-NP-2-0	Program operation is supported. Up to two axes can be operated.	1500 points	DC24V	(Power-saving specification) Rated: 1.3A Maximum: 2.5A	-	See the ROBO Cylinder general catalog

* This is for the single-axis ASEL.
* Enter the code "LA" in ① when the power-saving specification is specified.

RCA2-GD4NA

ROBO Cylinder Mini Rod Type Short-Length Double-guide Type Actuator Width 34mm 24V Servo Motor Ball Screw Specification/Lead Screw Specification

Model Description	RCA2 — GD4NA — I — 20 — <input type="text"/> — <input type="text"/> — <input type="text"/> — <input type="text"/> — <input type="text"/>							
Series	Type	Encoder type	Motor type	Lead	Stroke	Compatible controllers	Cable length	Option
I: Incremental specification * Model number is "I" when used with simple absolute unit.	20: Servo motor 20W	6: Ball screw 6mm 4: Ball screw 4mm 2: Ball screw 2mm 6S: Lead screw 6mm 4S: Lead screw 4mm 2S: Lead screw 2mm	30: 30mm 50: 50mm	A1: ACON RACON ASEL A3: AMEC ASEP	N: None P: 1 m S: 3 m M: 5 m X <input type="checkbox"/> : Length Designation	K2: Connector cable exits from the front LA: Power-saving specification		

* See page 14 for details on the model descriptions.

Power-saving specification



POINT
Notes on selection

- (1) The horizontal payload is the value when used in combination with a guide so that a radial load and moment load are not applied to the rod. See P129 for correlation diagrams of the end load and service life when a guide is not installed.
- (2) The payload is the value when the actuator is operated at an acceleration of 0.3 G (0.2G for lead 2, if used vertically and for lead screw specification). The acceleration limit is the value indicated above.
- (3) If the actuator is used vertically, pay attention to rod contact because the rod will come down when the power is turned off.

Actuator Specifications Table

Leads and Payloads

Model	Motor output (W)	Feed screw	Lead (mm)	Maximum payload		Rated thrust (N)	Positioning repeatability (mm)	Stroke (mm)
				Horizontal (kg)	Vertical (kg)			
RCA2-GD4NA-I-20-6-①-②-③-④	20	Ball screw	6	2	0.5	33.8	±0.02	30 50
RCA2-GD4NA-I-20-4-①-②-③-④			4	3	0.75	50.7		
RCA2-GD4NA-I-20-2-①-②-③-④			2	6	1.5	101.5		
RCA2-GD4NA-I-20-6S-①-②-③-④	20	Lead screw	6	0.25	0.125	19.9	±0.05	30 50
RCA2-GD4NA-I-20-4S-①-②-③-④			4	0.5	0.25	29.8		
RCA2-GD4NA-I-20-2S-①-②-③-④			2	1	0.5	59.7		

Legend ① Stroke ② Compatible Controllers ③ Cable length ④ Option

Stroke and Maximum Speed

Lead	Stroke	30 (mm)		50 (mm)	
		Ball screw	Lead screw	Ball screw	Lead screw
Ball screw	6	270 <220>	300		
	4	200			
	2	100			
Lead screw	6	220	300		
	4	200			
	2	100			

* <> Indicates vertical use (unit: mm/s)

① Stroke list

Stroke (mm)	Standard price	
	Ball screw	Lead screw
30	—	—
50	—	—

④ Options

Title	Option code	See page	Standard price
Connector cable exits from the front	K2	—	—
Power-saving specification	LA	—	—

③ Cable Length

Type	Cable symbol	Standard price
Standard type (Robot cable)	P (1m)	—
	S (3m)	—
	M (5m)	—
Special length	X06 (6m) ~ X10 (10m)	—
	X11 (11m) ~ X15 (15m)	—
	X16 (16m) ~ X20 (20m)	—
		—

* The standard cable for the RCA2 is the robot cable.

Actuator Specifications

Item	Description
Drive System	Ball screw/Lead screw, ø6mm, rolled C10
Lost motion	Ball screw: 0.1mm or less Lead screw: 0.3 mm or less
Frame	Material: Aluminum, white alumite treated
Ambient operating temperature, humidity	0 to 40°C, 85% RH or less (Non-condensing)
Service life	Horizontal specification: 10 million cycles, Vertical specification: 5 million cycles

RCS2-GD5N

ROBO Cylinder Mini Rod Type Shor-Length Double-guide type Actuator Width 46 mm
200V Servo Motor Ball Screw Specification

Model Description	RCS2 — GD5N — I — 60 — <input type="checkbox"/> — <input type="checkbox"/> — T2 — <input type="checkbox"/> — <input type="checkbox"/>							
Series	Type	Encoder type	Motor type	Lead	Stroke	Compatible controllers	Cable length	Option
I: Incremental specification	60: Servo motor 60W	10: 10mm 5: 5mm 2.5: 2.5mm	50: 50mm 75: 75mm	T2: SCON-CA SSEL XSEL-P/Q	N: None P: 1 m S: 3 m M: 5 m X□□: Length Designation R□□: Robot cable	K1: Connector cable exits from the left K2: Connector cable exits from the front K3: Connector cable exits from the right		

* See page 14 for details on the model descriptions.

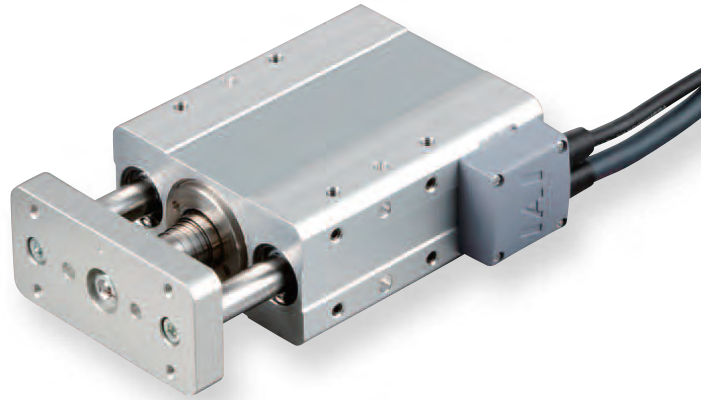

POINT
Notes on selection

- (1) The horizontal payload is the value when used in combination with a guide so that a radial load and moment load are not applied to the rod. See P129 for correlation diagrams of the end load and service life when a guide is not installed.
- (2) The payload is the value when the actuator is operated at an acceleration of 0.3 G (0.2G for lead 2.5) horizontally and 0.2G vertically. The acceleration limit is the value indicated above.
- (3) If the actuator is used vertically, pay attention to rod contact because the rod will come down when the power is turned off.

Actuator Specifications Table

Leads and Payloads

Model	Motor output (W)	Feed screw	Lead (mm)	Maximum payload		Rated thrust (N)	Positioning repeatability (mm)	Stroke (mm)
				Horizontal (kg)	Vertical (kg)			
RCS2-GD5N-I-60-10-①-T2-②-③	60	Ball screw	10	5	1.5	89	±0.02	50 75
RCS2-GD5N-I-60-5-①-T2-②-③			5	10	3	178		
RCS2-GD5N-I-60-2.5-①-T2-②-③			2.5	20	6	356		

Legend ① Stroke ② Cable length ③ Option

Stroke and Maximum Speed

Lead	Stroke	50 (mm)	75 (mm)
	10	280 <230>	380 <330>
5	250 <230>	250	
2.5	125		

* < > Indicates vertical use (unit: mm/s)

① Stroke list

Stroke (mm)	Standard price
50	—
75	—

② Cable Length

Type	Cable symbol	Standard price
Standard type	P (1m)	—
	S (3m)	—
	M (5m)	—
Special length	X06 (6m) ~ X10 (10m)	—
	X11 (11m) ~ X15 (15m)	—
	X16 (16m) ~ X20 (20m)	—
Robot cable	R01 (1m) ~ R03 (3m)	—
	R04 (4m) ~ R05 (5m)	—
	R06 (6m) ~ R10 (10m)	—
	R11 (11m) ~ R15 (15m)	—
	R16 (16m) ~ R20 (20m)	—
	R16 (16m) ~ R20 (20m)	—

③ Options

Title	Option code	See page	Standard price
Connector cable exits from the left	K1	Refer to the next page	—
Connector cable exits from the front	K2	Refer to the next page	—
Connector cable exits from the right	K3	Refer to the next page	—

Actuator Specifications

Item	Description
Drive System	Ball screw, ø8mm, rolled C10
Lost motion	0.1mm or less
Frame	Material: Aluminum, white alumite treated
Ambient operating temperature, humidity	0 to 40°C, 85% RH or less (Non-condensing)
Service life	5,000 km or 50 million cycles

Dimensional Drawings

- *1 Connect the motor and encoder cables.
 - *2 During home return, be careful to avoid interference from peripheral objects because the rod travels until the mechanical end.
- ME: Mechanical end SE: Stroke end

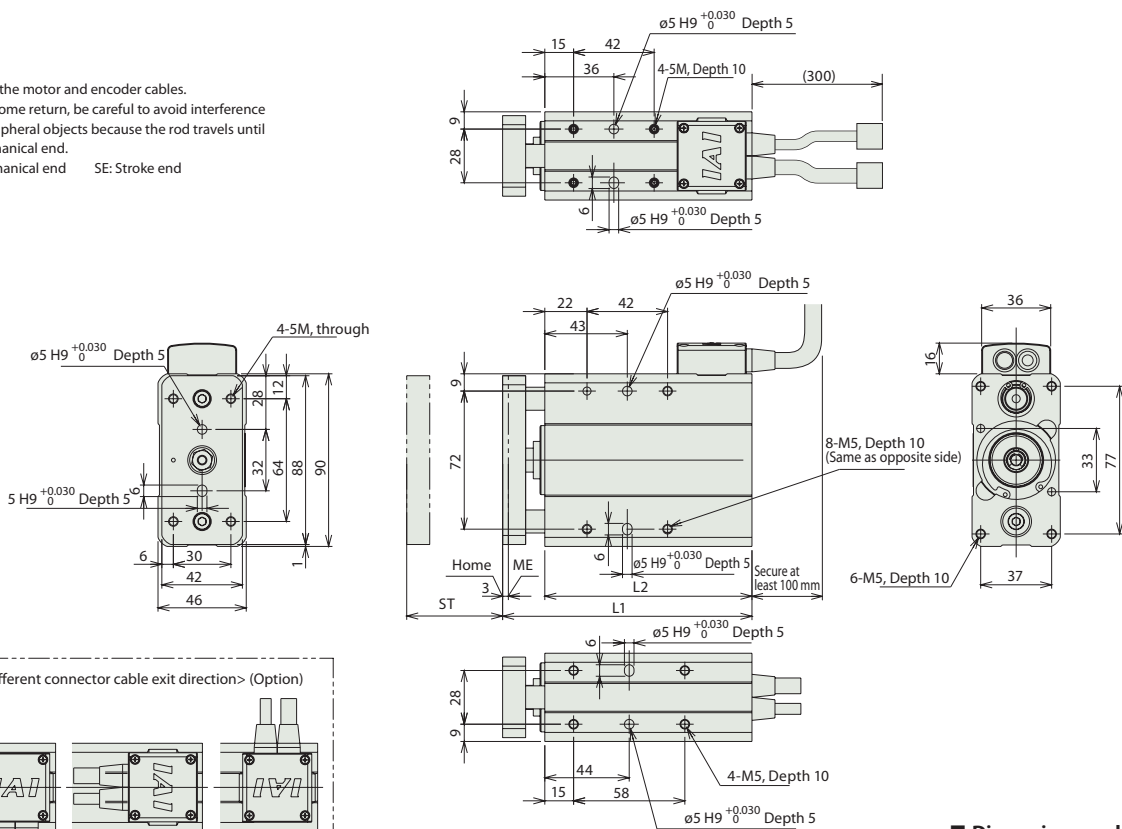

■ Dimensions and Weight by Stroke

Stroke	50	75
L1	130	155
L2	108	133
Mass (kg)	1.6	1.9

Compatible Controllers

RCS2 series actuators can be operated with the controllers indicated below. Select the type according to your intended application.

Title	External View	Model	Features	Maximum number of positioning points	Input power	Power-supply capacity	Standard price	Reference Page
Positioner mode		SCON-CA-60I-NP-2-①	Up to 512 positioning points are supported.	512 points	Single-phase 100 VAC	218 VA max.	-	→ P157
Solenoid mode			Can be operated with the same controls used for solenoid valves.	7 points				
Pulse-train input control mode			Can be controlled using pulse trains.	(-)				
Network mode			Can be moved by direct numerical specification.	768 points	Single-phase 200 VAC			
Program control type, 1 or 2 axes		SSEL-C-1-60I-NP-2-①	Program operation is supported. Up to two axes can be operated.	20000 points	3-phase 200 VAC (XSEL-P/Q only)			See the ROBO Cylinder general catalog
Program control type, 1 to 6 axes		XSEL-①-1-60I-N1-EEE-2-3	Program operation is supported. Up to six axes can be operated.	20000 points				

* The values of SSEL and XSEL assume a 1-axis specification.
 * ① indicates the type of power-supply voltage (1: 100 V/2: Single-phase 200 V).
 * ② indicates the XSEL type (P/Q).

- Mini Slider type
- Mini Rod type
- Mini Table type
- Mini Servo Linear type
- Controller
- Fixed Nut
- Tapped Hole
- Single-Guide
- Double-Guide
- Slide Unit

RCA2-SD3NA

ROBO Cylinder Mini Rod Type Short-Length Double-Guide Slide Unit Type Actuator Width 60 mm
24V Servo Motor Ball Screw Specification/Lead Screw Specification

Model Description	RCA2 — SD3NA — I — 10 — <input type="checkbox"/> — <input type="checkbox"/> — <input type="checkbox"/> — <input type="checkbox"/> — <input type="checkbox"/>							
Series	Type	Encoder type	Motor type	Lead	Stroke	Compatible controllers	Cable length	Option
I: Incremental specification * Model number is "I" when used with simple absolute unit.	10: Servo motor 10W	4: Ball screw 4mm 2: Ball screw 2mm 1: Ball screw 1mm 4S: Lead screw 4mm 2S: Lead screw 2mm 1S: Lead screw 1mm	25: 25mm 50: 50mm	A1: ACON RACON ASEL A3: AMEC ASEP	N: None P: 1 m S: 3 m M: 5 m X□□: Length Designation	LA: Power-saving specification		

* See page 14 for details on the model descriptions.

Power-saving specification

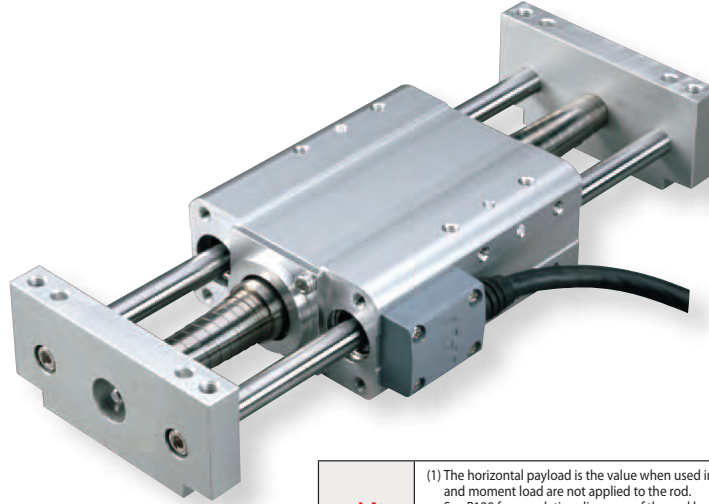

POINT
Notes on selection

- (1) The horizontal payload is the value when used in combination with a guide so that a radial load and moment load are not applied to the rod. See P129 for correlation diagrams of the end load and service life when a guide is not installed.
- (2) The payload is the value when the actuator is operated at an acceleration of 0.3 G (0.2G for lead 1, if used vertically and for lead screw specification). The acceleration limit is the value indicated above.
- (3) The vertical payload is the value when the actuator is mounted and side bracket is operated. Take note that in vertical operation, the side bracket cannot be mounted to operate the actuator.
- (4) If the actuator is used vertically, pay attention to rod contact because the rod will come down when the power is turned off.

Actuator Specifications Table

Leads and Payloads

Model	Motor output (W)	Feed screw	Lead (mm)	Maximum payload		Rated thrust (N)	Positioning repeatability (mm)	Stroke (mm)
				Horizontal (kg)	Vertical (kg)			
RCA2-SD3NA-I-10-4-①-②-③-④	10	Ball screw	4	0.75	0.25(*)	42.7	±0.02	25 50
RCA2-SD3NA-I-10-2-①-②-③-④			2	1.5	0.5(*)	85.5		
RCA2-SD3NA-I-10-1-①-②-③-④			4	3	1(*)	170.9		
RCA2-SD3NA-I-10-4S-①-②-③-④	10	Lead screw	4	0.25	0.125(*)	25.1	±0.05	25 50
RCA2-SD3NA-I-10-2S-①-②-③-④			2	0.5	0.25(*)	50.3		
RCA2-SD3NA-I-10-1S-①-②-③-④			1	1	0.5(*)	100.5		

Legend ① Stroke ② Compatible Controllers ③ Cable length ④ Option

(*) When the main unit side is fixed

Stroke and Maximum Speed

Lead	Stroke	25 (mm)	50 (mm)
		Ball screw	4
2	100		
1	50		
Lead screw	4	200	
	2	100	
	1	50	

(unit: mm/s)

① Stroke list

Stroke (mm)	Standard price	
	Feed screw	
	Ball screw	Lead screw
25	—	—
50	—	—

③ Cable Length

Type	Cable symbol	Standard price
Standard type (Robot cable)	P (1m)	—
	S (3m)	—
	M (5m)	—
Special length	X06 (6m) ~ X10 (10m)	—
	X11 (11m) ~ X15 (15m)	—
	X16 (16m) ~ X20 (20m)	—
		—

* The standard cable for the RCA2 is the robot cable.

④ Options

Title	Option code	See page	Standard price
Power-saving specification	LA	—	—

Actuator Specifications

Item	Description
Drive System	Ball screw/Lead screw, ø4mm, rolled C10
Lost motion	Ball screw: 0.1mm or less Lead screw: 0.3 mm or less
Frame	Material: Aluminum, white alumite treated
Ambient operating temperature, humidity	0 to 40°C, 85% RH or less (Non-condensing)
Service life	Lead screw specification Horizontal specification: 10 million cycles, Vertical specification: 5 million cycles

Dimensional Drawings

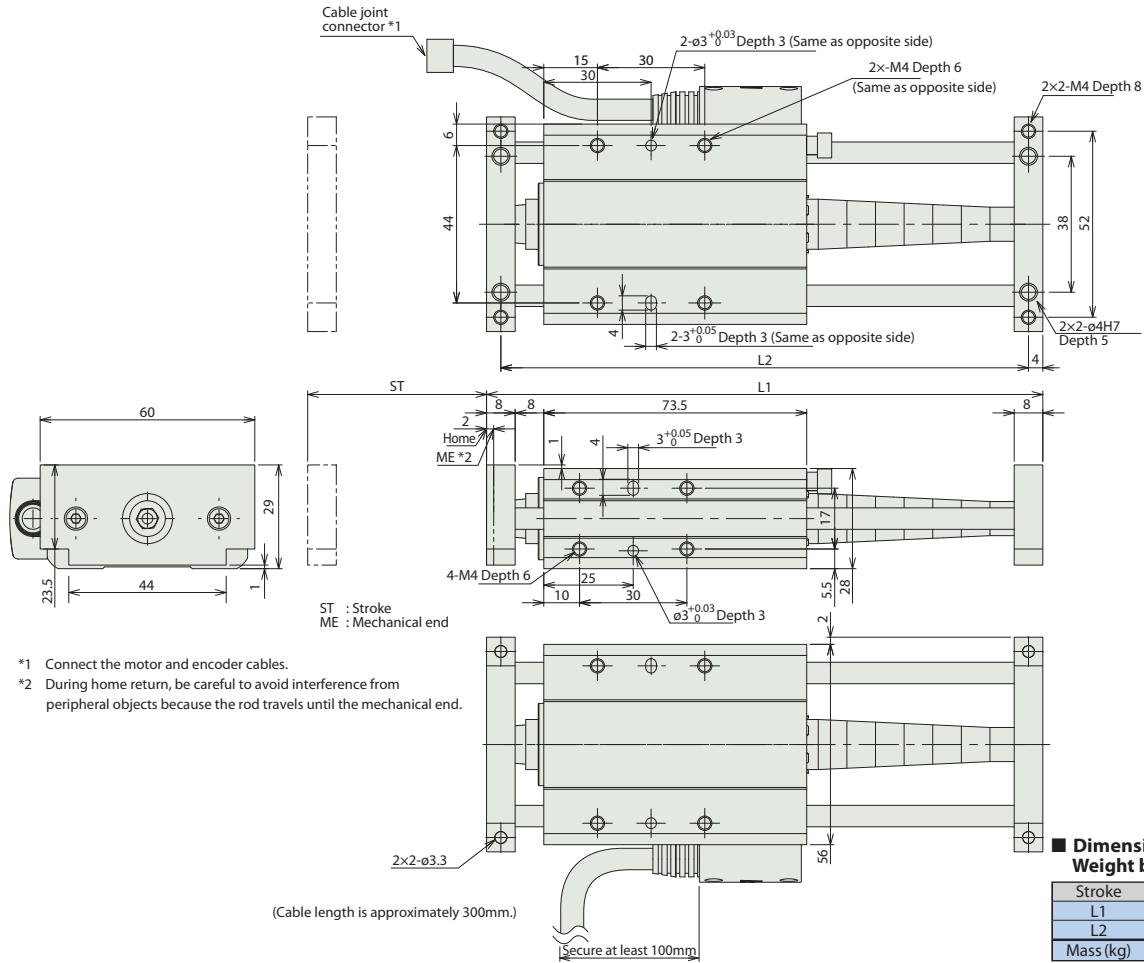

- *1 Connect the motor and encoder cables.
- *2 During home return, be careful to avoid interference from peripheral objects because the rod travels until the mechanical end.

Compatible Controllers

RCA2 series actuators can be operated with the controllers indicated below. Select the type according to your intended application.

Title	External View	Model	Features	Maximum number of positioning points	Input power	Power-supply capacity	Standard price	Reference Page
Solenoid valve type		AMEC-C-10①-NP-2-1	Easy-to-use controller, even for beginners	3 points	AC100V	Rated: 2.4A	-	→ P131
		ASEP-C-10①-NP-2-0	Operable with the same signal as a solenoid valve. Supports both single and double solenoid types. No homing necessary with the simple absolute type.					→ P141
Splash-proof solenoid valve type		ASEP-CW-10①-NP-2-0						
Positioner type		ACON-C-10①-NP-2-0	Up to 512 positioning points are supported.	512 points	DC24V	(Standard specification) Rated: 1.3A Maximum: 4.4 A	-	See the ROBO Cylinder general catalog
Safety-compliant positioner type		ACON-CG-10①-NP-2-0						
Pulse-train input type (Differential line driver)		ACON-PL-10①-NP-2-0	Pulse-train input type with differential line driver support	(-)	DC24V	(Power-saving specification) Rated: 1.3A Maximum: 2.5A	-	
Pulse-train input type (Open collector)		ACON-PO-10①-NP-2-0	Pulse-train input type with open collector support					
Serial communication type		ACON-SE-10①-N-0-0	Dedicated to serial communication	64 points				
Field network type		RACON-10①	Dedicated to a field network	768 points				
Program control type		ASEL-C-1-10①-NP-2-0	Program operation is supported. Up to two axes can be operated.	1500 points				

* This is for the single-axis ASEL
* Enter the code "LA" in ① when the power-saving specification is specified.

- Mini Slider type
- Mini Rod type
- Mini Table type
- Mini Linear Servo type
- Controller
- Fixed Nut
- Tapped Hole
- Single-Guide
- Double-Guide
- Slide Unit

RCA2-SD4NA

ROBO Cylinder Mini Rod Type Short-Length, Double-Guide Slide Unit Type Actuator Width 72 mm
24V Servo Motor Ball Screw Specification/Lead Screw Specification

Model Description	RCA2 — SD4NA — I — 20 — <input type="checkbox"/> — <input type="checkbox"/> — <input type="checkbox"/> — <input type="checkbox"/> — <input type="checkbox"/>							
Series	Type	Encoder type	Motor type	Lead	Stroke	Compatible controllers	Cable length	Option
I: Incremental specification * Model number is "I" when used with simple absolute unit.	20: Servo motor 20W	6: Ball screw 6mm 4: Ball screw 4mm 2: Ball screw 2mm 6S: Lead screw 6mm 4S: Lead screw 4mm 2S: Lead screw 2mm	25: 25mm 50: 50mm 75: 75mm	A1: ACON RACON ASEL A3: AMEC ASEP	N: None P: 1 m S: 3 m M: 5 m X <input type="checkbox"/> : Length Designation	LA: Power-saving specification		

* See page 14 for details on the model descriptions.

Power-saving specification

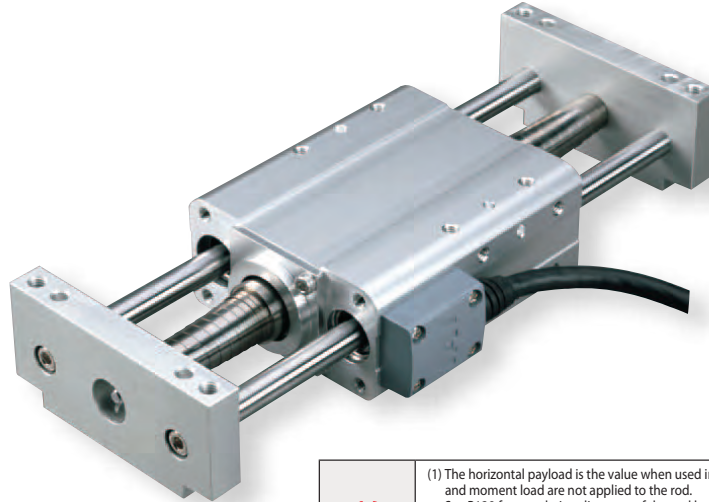

- POINT**
Notes on selection
- (1) The horizontal payload is the value when used in combination with a guide so that a radial load and moment load are not applied to the rod. See P129 for correlation diagrams of the end load and service life when a guide is not installed.
 - (2) The payload is the value when the actuator is operated at an acceleration of 0.3 G (0.2G for lead 2, if used vertically and for lead screw specification). The acceleration limit is the value indicated above.
 - (3) The vertical payload is the value when the actuator is mounted and side bracket is operated. Take note that in vertical operation, the side bracket cannot be mounted to operate the actuator.
 - (4) If the actuator is used vertically, pay attention to rod contact because the rod will come down when the power is turned off.

Actuator Specifications Table

Leads and Payloads

Model	Motor output (W)	Feed screw	Lead (mm)	Maximum payload		Rated thrust (N)	Positioning repeatability (mm)	Stroke (mm)
				Horizontal (kg)	Vertical (kg)			
RCA2-SD4NA-I-20-6-①-②-③-④	20	Ball screw	6	2	0.5 (*1)	33.8	±0.02	25 50 75
RCA2-SD4NA-I-20-4-①-②-③-④			4	3	0.75 (*1)	50.7		
RCA2-SD4NA-I-20-2-①-②-③-④			2	6	1.5 (*1)	101.5		
RCA2-SD4NA-I-20-6S-①-②-③-④	20	Lead screw	6	0.25	0.125 (*1)	19.9	±0.05	25 50 75
RCA2-SD4NA-I-20-4S-①-②-③-④			4	0.5	0.25 (*1)	29.8		
RCA2-SD4NA-I-20-2S-①-②-③-④			2	1	0.5 (*1)	59.7		

Legend ① Stroke ② Compatible Controllers ③ Cable length ④ Option

Stroke and Maximum Speed

Lead	Stroke	Maximum Speed	
		25 (mm)	50~75 (mm)
Ball screw	6	240 <200>	300
	4	200	
	2	100	
Lead screw	6	200	300
	4	200	
	2	100	

* < > Indicates vertical use

(unit: mm/s)

① Stroke list

Stroke (mm)	Standard price	
	Ball screw	Lead screw
25	—	—
50	—	—
75	—	—

③ Cable Length

Type	Cable symbol	Standard price
Standard type (Robot cable)	P (1m)	—
	S (3m)	—
	M (5m)	—
Special length	X06 (6m) ~ X10 (10m)	—
	X11 (11m) ~ X15 (15m)	—
	X16 (16m) ~ X20 (20m)	—

* The standard cable for the RCA2 is the robot cable.

④ Options

Title	Option code	See page	Standard price
Power-saving specification	LA	—	—

Actuator Specifications

Item	Description
Drive System	Ball screw/Lead screw, ø6mm, rolled C10
Lost motion	Ball screw: 0.1mm or less Lead screw: 0.3 mm or less
Frame	Material: Aluminum, white alumite treated
Ambient operating temperature, humidity	0 to 40°C, 85% RH or less (Non-condensing)
Service life	Horizontal specification: 10 million cycles, Vertical specification: 5 million cycles

RCS2-SD5N

ROBO Cylinder Mini Rod Type Short-Length Double-Guide Slide Unit Type Actuator Width 94 mm
200V Servo Motor Ball Screw Specification

Model Description	RCS2 — SD5N — I — 60 — <input type="checkbox"/> — <input type="checkbox"/> — T2 — <input type="checkbox"/> — <input type="checkbox"/>							
Series	Type	Encoder type	Motor type	Lead	Stroke	Compatible controllers	Cable length	Option
I: Incremental specification	60: Servo motor 60W	10: 10mm 5: 5mm 2.5: 2.5mm	50: 50mm 75: 75mm	T2: SCON-CA SSEL XSEL-P/Q	N: None P: 1 m S: 3 m M: 5 m X <input type="checkbox"/> : Length Designation R <input type="checkbox"/> : Robot cable	K1: Connector cable exits from the left K3: Connector cable exits from the right		

* See page 14 for details on the model descriptions.

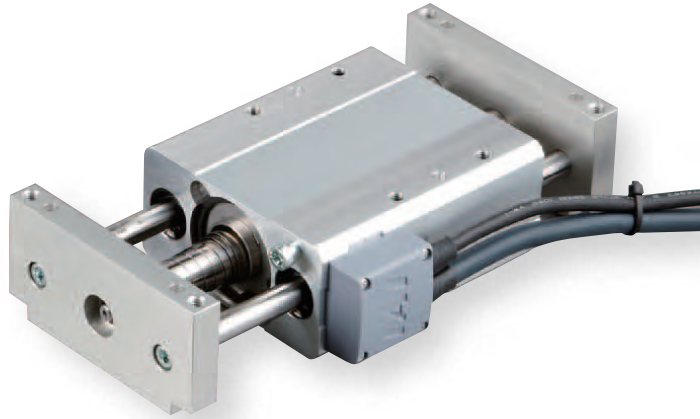

Notes on selection

- The horizontal payload is the value when used in combination with a guide so that a radial load and moment load are not applied to the rod. See P129 for correlation diagrams of the end load and service life when a guide is not installed.
- The payload is the value when the actuator is operated at an acceleration of 0.3 G (0.2G for lead 2.5) horizontally and 0.2G vertically. The acceleration limit is the value indicated above.
- The vertical payload is the value when the actuator is mounted and side bracket is operated. Take note that in vertical operation, the side bracket cannot be mounted to operate the actuator.
- If the actuator is used vertically, pay attention to rod contact because the rod will come down when the power is turned off.

Actuator Specifications Table

Leads and Payloads

Model	Motor output (W)	Feed screw	Lead (mm)	Maximum payload		Rated thrust (N)	Positioning repeatability (mm)	Stroke (mm)
				Horizontal (kg)	Vertical (kg)			
RCS2-SD5N-I-60-10-①-T2-②-③	60	Ball screw	10	5	1.5	89	±0.02	50 75
RCS2-SD5N-I-60-5-①-T2-②-③			5	10	3	178		
RCS2-SD5N-I-60-2.5-①-T2-②-③			2.5	20	6	356		

Legend ① Stroke ② Cable length ③ Option

Stroke and Maximum Speed

Lead	Stroke	50 (mm)	75 (mm)
	10	280 <230>	380 <330>
5	250 <230>	250	
2.5	125		

* < > Indicates vertical use (unit: mm/s)

① Stroke list

Stroke (mm)	Standard price
50	—
75	—

② Cable Length

Type	Cable symbol	Standard price
Standard type	P (1m)	—
	S (3m)	—
	M (5m)	—
Special length	X06 (6m) ~ X10 (10m)	—
	X11 (11m) ~ X15 (15m)	—
	X16 (16m) ~ X20 (20m)	—
Robot cable	R01 (1m) ~ R03 (3m)	—
	R04 (4m) ~ R05 (5m)	—
	R06 (6m) ~ R10 (10m)	—
	R11 (11m) ~ R15 (15m)	—
	R16 (16m) ~ R20 (20m)	—

③ Options

Title	Option code	See page	Standard price
Connector cable exits from the left	K1	Refer to the next page	—
Connector cable exits from the right	K3	Refer to the next page	—

Actuator Specifications

Item	Description
Drive System	Ball screw, ø8mm, rolled C10
Lost motion	0.1mm or less
Frame	Material: Aluminum, white alumite treated
Ambient operating temperature, humidity	0 to 40°C, 85% RH or less (Non-condensing)
Service life	5,000 km or 50 million cycles

RCA2-TCA3NA

ROBO Cylinder Mini Rod Type Short-Length Compact Type Actuator Width 32 mm 24V Servo Motor
Ball Screw Specification/Lead Screw Specification

Model Description	RCA2 — TCA3NA — I — 10 — [] — [] — [] — [] — []							
Series	Type	Encoder type	Motor type	Lead	Stroke	Compatible controllers	Cable length	Option
I: Incremental specification * Model number is "I" when used with simple absolute unit.	10: Servo motor 10W	4: Ball screw 4mm 2: Ball screw 2mm 1: Ball screw 1mm 4S: Lead screw 4mm 2S: Lead screw 2mm 1S: Lead screw 1mm		30: 30mm 50: 50mm	A1: ACON RACON ASEL A3: AMEC ASEP	N: None P: 1 m S: 3 m M: 5 m X□□: Length Designation	K2: Connector cable exits from the front LA: Power-saving specification	

* See page 14 for details on the model descriptions.

Power-saving specification

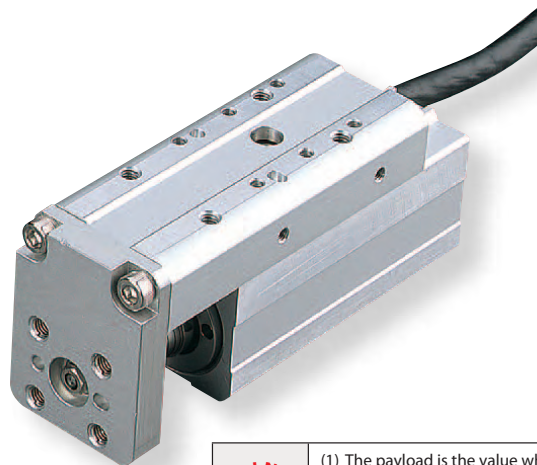

- POINT**
Notes on selection
- (1) The payload is the value when the actuator is operated at an acceleration of 0.3 G (0.2G for lead 1, if used vertically and for lead screw specification). The acceleration limit is the value indicated above.
 - (2) If the actuator is used vertically, pay attention to rod contact because the rod will come down when the power is turned off.

Actuator Specifications Table

Leads and Payloads

Model	Motor output (W)	Feed screw	Lead (mm)	Maximum payload		Rated thrust (N)	Positioning repeatability (mm)	Stroke (mm)
				Horizontal (kg)	Vertical (kg)			
RCA2-TCA3NA-I-10-4-①-②-③-④	10	Ball screw	4	0.75	0.25	42.7	±0.02	30 50
RCA2-TCA3NA-I-10-2-①-②-③-④			2	1.5	0.5	85.5		
RCA2-TCA3NA-I-10-1-①-②-③-④			1	3	1	170.9		
RCA2-TCA3NA-I-10-4S-①-②-③-④	10	Lead screw	4	0.25	0.125	25.1	±0.05	30 50
RCA2-TCA3NA-I-10-2S-①-②-③-④			2	0.5	0.25	50.3		
RCA2-TCA3NA-I-10-1S-①-②-③-④			1	1	0.5	100.5		

Stroke and Maximum Speed

Lead	Stroke	30 (mm)		50 (mm)	
		Ball screw	Lead screw	Ball screw	Lead screw
Ball screw	4	—	200	—	—
	2	—	100	—	—
Lead screw	1	—	50	—	—
	4	—	200	—	—
Lead screw	2	—	100	—	—
	1	—	50	—	—

Legend ① Stroke ② Compatible Controllers ③ Cable length ④ Option (unit: mm/s)

① Stroke list

Stroke (mm)	Standard price	
	Feed screw	
	Ball screw	Lead screw
30	—	—
50	—	—

③ Cable Length

Type	Cable symbol	Standard price
Standard type (Robot cable)	P (1m)	—
	S (3m)	—
	M (5m)	—
Special length	X06 (6m) ~ X10 (10m)	—
	X11 (11m) ~ X15 (15m)	—
	X16 (16m) ~ X20 (20m)	—

* The standard cable for the RCA2 is the robot cable.

④ Options

Title	Option code	See page	Standard price
Connector cable exits from the front	K2	—	—
Power-saving specification	LA	—	—

Actuator Specifications

Item	Description
Drive System	Ball screw/Lead screw, ø4mm, rolled C10
Lost motion	Ball screw: 0.1mm or less Lead screw: 0.3 mm or less
Frame	Material: Aluminum, white alumite treated
Dynamic allowable moment (see note)	Ma: 9.9 N·m Mb: 9.9 N·m Mc: 3.3 N·m
Ambient operating temperature, humidity	0 to 40°C, 85% RH or less (Non-condensing)
Service life	Lead screw specification
	Ball screw specification
	Horizontal specification: 10 million cycles, Vertical specification: 5 million cycles 5,000 km or 50 million cycles (*)

(Note) For cases when the guide service life has been set to 5,000km.

(*) For lead 1: 3,000 km or 50 million cycles

Dimensional Drawings

- *1 Connect the motor and encoder cables.
- *2 During home return, be careful to avoid interference from peripheral objects because the rod travels until the mechanical end.

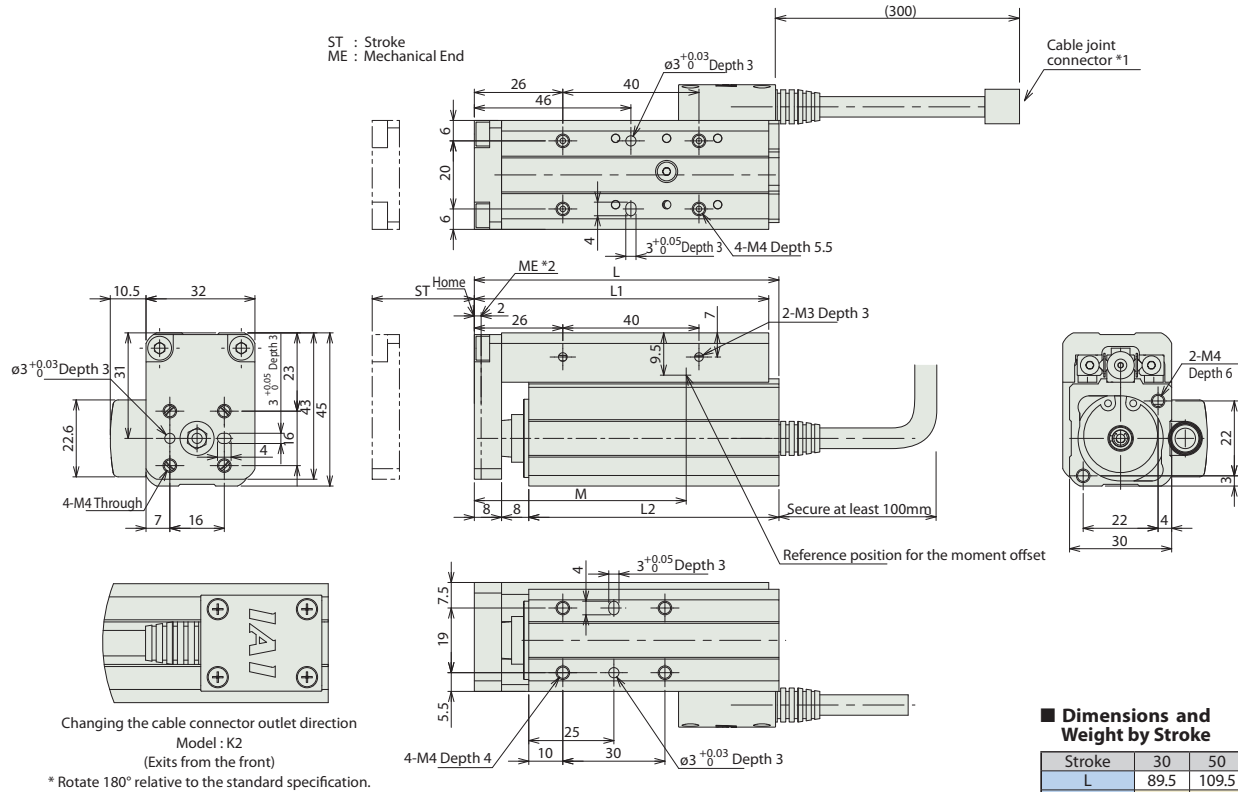

Dimensions and Weight by Stroke

Stroke	30	50
L	89.5	109.5
L1	86.5	106.5
L2	73.5	93.5
M	64	84
Mass (kg)	0.37	0.44

Compatible Controllers

RCA2 series actuators can be operated with the controllers indicated below. Select the type according to your intended application.

Title	External View	Model	Features	Maximum number of positioning points	Input power	Power-supply capacity	Standard price	Reference Page
Solenoid valve type		AMEC-C-10①-NP-2-1	Easy-to-use controller, even for beginners	3 points	AC100V	Rated: 2.4A	-	→ P131
Splash-proof solenoid valve type		ASEP-C-10①-NP-2-0	Operable with the same signal as a solenoid valve. Supports both single and double solenoid types. No homing necessary with the simple absolute type.					→ P141
Positioner type		ACON-C-10①-NP-2-0	Up to 512 positioning points are supported.	512 points	DC24V	(Standard specification) Rated: 1.3A Maximum: 4.4 A	-	See the ROBO Cylinder general catalog
Safety-compliant positioner type		ACON-CG-10①-NP-2-0						
Pulse-train input type (Differential line driver)		ACON-PL-10①-NP-2-0	Pulse-train input type with differential line driver support	(-)	(Power-saving specification) Rated: 1.3A Maximum: 2.5A	-		
Pulse-train input type (Open collector)		ACON-PO-10①-NP-2-0	Pulse-train input type with open collector support					
Serial communication type		ACON-SE-10①-N-0-0	Dedicated to serial communication	64 points		-		
Field network type		RACON-10①	Dedicated to a field network	768 points		-		
Program control type		ASEL-C-1-10①-NP-2-0	Program operation is supported. Up to two axes can be operated.	1500 points		-		

* This is for the single-axis ASEL
* Enter the code "LA" in ① when the power-saving specification is specified.



RCA2-TCA4NA

ROBO Cylinder Mini Table Type Short-Length Compact Type Actuator Width 36 mm 24V Servo Motor Ball Screw Specification/Lead Screw Specification

Model Description	RCA2 — TCA4NA — I — 20 — [] — [] — [] — [] — []							
Series	Type	Encoder type	Motor type	Lead	Stroke	Compatible controllers	Cable length	Option
I: Incremental specification * Model number is "I" when used with simple absolute unit.	20: Servo motor 20W	6: Ball screw 6mm 4: Ball screw 4mm 2: Ball screw 2mm 6S: Lead screw 6mm 4S: Lead screw 4mm 2S: Lead screw 2mm	30: 30mm 50: 50mm	A1: ACON RACON ASEL A3: AMEC ASEP	N: None P: 1 m S: 3 m M: 5 m X□□: Length Designation	K2: Connector cable exits from the front LA: Power-saving specification		

* See page 14 for details on the model descriptions.

Power-saving specification

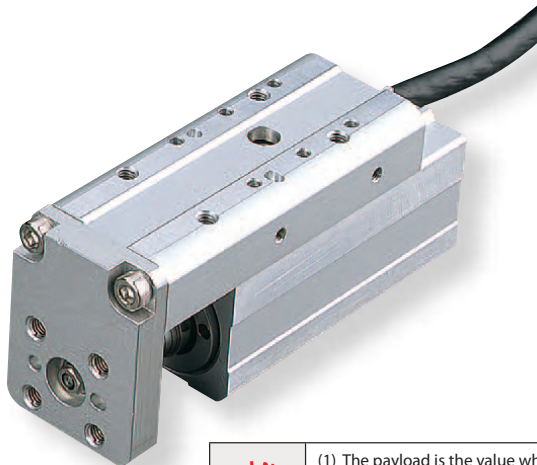

- (1) The payload is the value when the actuator is operated at an acceleration of 0.3 G (0.2G for lead 2, if used vertically and for lead screw specification). The acceleration limit is the value indicated above.
- (2) If the actuator is used vertically, pay attention to rod contact because the rod will come down when the power is turned off.

Actuator Specifications Table

Leads and Payloads

Model	Motor output (W)	Feed screw	Lead (mm)	Maximum payload		Rated thrust (N)	Positioning repeatability (mm)	Stroke (mm)
				Horizontal (kg)	Vertical (kg)			
RCA2-TCA4NA-I-20-6-①-②-③-④	20	Ball screw	6	2	0.5	33.8	±0.02	30 50
RCA2-TCA4NA-I-20-4-①-②-③-④			4	3	0.75	50.7		
RCA2-TCA4NA-I-20-2-①-②-③-④			2	6	1.5	101.5		
RCA2-TCA4NA-I-20-6S-①-②-③-④	20	Lead screw	6	0.25	0.125	19.9	±0.05	30 50
RCA2-TCA4NA-I-20-4S-①-②-③-④			4	0.5	0.25	29.8		
RCA2-TCA4NA-I-20-2S-①-②-③-④			2	1	0.5	59.7		

Legend ① Stroke ② Compatible Controllers ③ Cable length ④ Option

Stroke and Maximum Speed

Lead	Stroke	30 (mm)		50 (mm)	
		Ball screw	Lead screw	Ball screw	Lead screw
Ball screw	6	270 <220>	300		
	4	200			
Lead screw	2	100			
	6	220	300		
Lead screw	4	200			
	2	100			

* <> Indicates vertical use (unit: mm/s)

① Stroke list

Stroke (mm)	Standard price	
	Ball screw	Lead screw
30	—	—
50	—	—

③ Cable Length

Type	Cable symbol	Standard price
Standard type (Robot cable)	P (1m)	—
	S (3m)	—
	M (5m)	—
Special length	X06 (6m) ~ X10 (10m)	—
	X11 (11m) ~ X15 (15m)	—
	X16 (16m) ~ X20 (20m)	—

* The standard cable for the RCA2 is the robot cable.

④ Options

Title	Option code	See page	Standard price
Connector cable exits from the front	K2	—	—
Power-saving specification	LA	—	—

Actuator Specifications

Item	Description
Drive System	Ball screw/Lead screw, ø6mm, rolled C10
Lost motion	Ball screw: 0.1mm or less Lead screw: 0.3 mm or less
Frame	Material: Aluminum, white alumite treated
Dynamic allowable moment (see note)	Ma: 9.9 N·m Mb: 9.9 N·m Mc: 3.3 N·m
Ambient operating temperature, humidity	0 to 40°C, 85% RH or less (Non-condensing)
Service life	Lead screw specification
	Ball screw specification
	Horizontal specification: 10 million cycles, Vertical specification: 5 million cycles 5,000 km or 50 million cycles (*)

(Note) For cases when the guide service life has been set to 5,000km.

Dimensional Drawings

- *1 Connect the motor and encoder cables.
- *2 During home return, be careful to avoid interference from peripheral objects because the rod travels until the mechanical end.

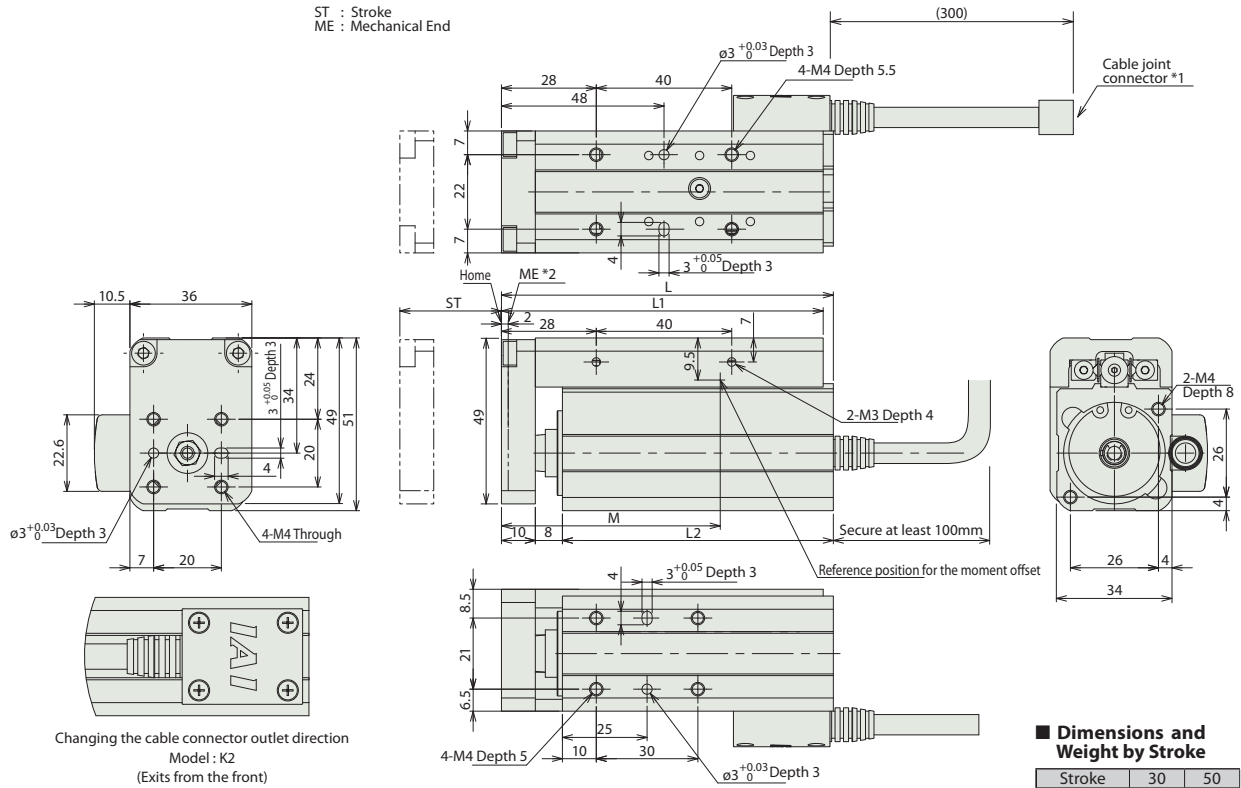

■ Dimensions and Weight by Stroke

Stroke	30	50
L	98	118
L1	95	115
L2	50	100
M	66	86
Mass (kg)	0.48	0.6

② Compatible Controllers

RCA2 series actuators can be operated with the controllers indicated below. Select the type according to your intended application.

Title	External View	Model	Features	Maximum number of positioning points	Input power	Power-supply capacity	Standard price	Reference Page
Solenoid valve type		AMEC-C-20①-NP-2-1	Easy-to-use controller, even for beginners	3 points	AC100V	Rated: 2.4A	-	→ P131
		ASEP-C-20①-NP-2-0	Operable with the same signal as a solenoid valve. Supports both single and double solenoid types. No homing necessary with the simple absolute type.					
Splash-proof solenoid valve type		ASEP-CW-20①-NP-2-0						→ P141
Positioner type		ACON-C-20①-NP-2-0	Up to 512 positioning points are supported.	512 points	DC24V	(Standard specification) Rated: 1.3A Maximum: 4.4 A	-	See the ROBO Cylinder general catalog
Safety-compliant positioner type		ACON-CG-20①-NP-2-0						
Pulse-train input type (Differential line driver)		ACON-PL-20①-NP-2-0	Pulse-train input type with differential line driver support	(-)		(Power-saving specification) Rated: 1.3A Maximum: 2.5A	-	
Pulse-train input type (Open collector)		ACON-PO-20①-NP-2-0	Pulse-train input type with open collector support					
Serial communication type		ACON-SE-20①-N-0-0	Dedicated to serial communication	64 points				
Field network type		RACON-20①	Dedicated to a field network	768 points				
Program control type		ASEL-C-1-20①-NP-2-0	Program operation is supported. Up to two axes can be operated.	1500 points				

* This is for the single-axis ASEL
* Enter the code "LA" in ① when the power-saving specification is specified.



RCS2-TCA5N

ROBO Cylinder Mini Table Type Short-Length Compact Type Actuator Width 48 mm 200V Servo Motor Ball Screw Specification

Model Description	RCS2 — TCA5N — I — 60 — <input type="checkbox"/> — <input type="checkbox"/> — T2 — <input type="checkbox"/> — <input type="checkbox"/>							
Series	Type	Encoder type	Motor type	Lead	Stroke	Compatible controllers	Cable length	Option
		I: Incremental specification	60: Servo motor 60W	10: 10mm 5: 5mm 2.5: 2.5mm	50: 50mm 75: 75mm	T2: SCON-CA SSEL XSEL-P/Q	N: None P: 1 m S: 3 m M: 5 m X <input type="checkbox"/> : Length Designation R <input type="checkbox"/> : Robot cable	K1: Connector cable exits from the left K2: Connector cable exits from the front K3: Connector cable exits from the right

* See page 14 for details on the model descriptions.

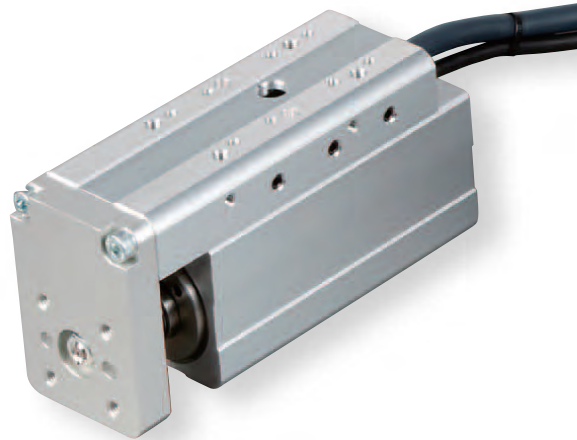

- (1) The payload is the value when the actuator is operated at an acceleration of 0.3 G (0.2G for lead 2.5) horizontally and 0.2G vertically. The acceleration limit is the value indicated above.
- (2) If the actuator is used vertically, pay attention to rod contact because the rod will come down when the power is turned off.

Actuator Specifications Table

Leads and Payloads

Model	Motor output (W)	Feed screw	Lead (mm)	Maximum payload		Rated thrust (N)	Positioning repeatability (mm)	Stroke (mm)
				Horizontal (kg)	Vertical (kg)			
RCS2-TCA5N-I-60-10- <input type="checkbox"/> -T2- <input type="checkbox"/> - <input type="checkbox"/>	60	Ball screw	10	5	1.5	89	±0.02	50 75
RCS2-TCA5N-I-60-5- <input type="checkbox"/> -T2- <input type="checkbox"/> - <input type="checkbox"/>			5	10	3	178		
RCS2-TCA5N-I-60-2.5- <input type="checkbox"/> -T2- <input type="checkbox"/> - <input type="checkbox"/>			2.5	20	6	356		

Legend Stroke Cable length Option

Stroke and Maximum Speed

Lead	Stroke	50 (mm)	75 (mm)
		10	280 <230>
5	250 <230>	250	
2.5		125	

* <> Indicates vertical use (unit: mm/s)

① Stroke list

Stroke (mm)	Standard price
50	—
75	—

② Cable Length

Type	Cable symbol	Standard price
Standard type	P (1m)	—
	S (3m)	—
	M (5m)	—
Special length	X06 (6m) ~ X10 (10m)	—
	X11 (11m) ~ X15 (15m)	—
	X16 (16m) ~ X20 (20m)	—
Robot cable	R01 (1m) ~ R03 (3m)	—
	R04 (4m) ~ R05 (5m)	—
	R06 (6m) ~ R10 (10m)	—
	R11 (11m) ~ R15 (15m)	—
	R16 (16m) ~ R20 (20m)	—

③ Options

Title	Option code	See page	Standard price
Connector cable exits from the left	K1	Refer to the next page	—
Connector cable exits from the front	K2	Refer to the next page	—
Connector cable exits from the right	K3	Refer to the next page	—

Actuator Specifications

Item	Description
Drive System	Ball screw, ø8mm, rolled C10
Lost motion	0.1mm or less
Frame	Material: Aluminum, white alumite treated
Dynamic allowable moment (see note)	Ma: 15 N·m Mb: 15 N·m Mc: 7.1 N·m
Ambient operating temperature, humidity	0 to 40°C, 85% RH or less (Non-condensing)
Service life	5,000 km or 50 million cycles

(Note) For cases when the guide service life has been set to 5,000km.

75 RCS2-TCA5N

Dimensional Drawings

- *1 Connect the motor and encoder cables.
- *2 During home return, be careful to avoid interference from peripheral objects because the rod travels until the mechanical end.
ME: Mechanical end SE: Stroke end

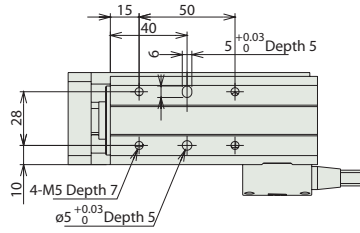
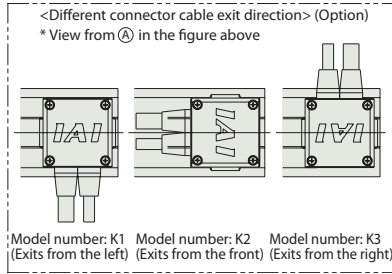
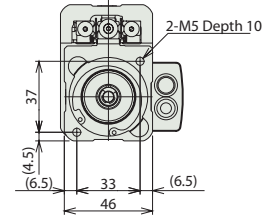
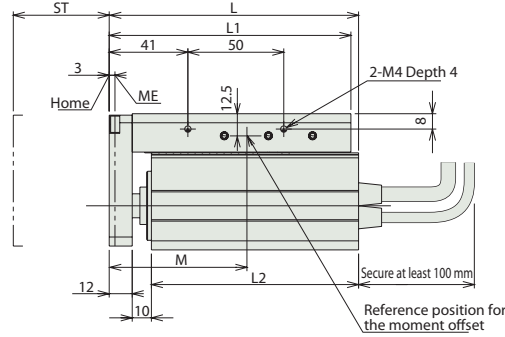
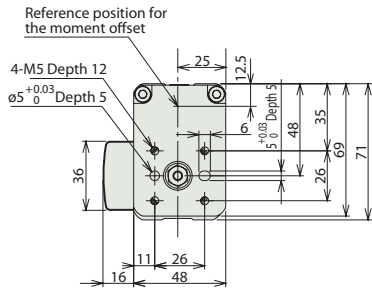
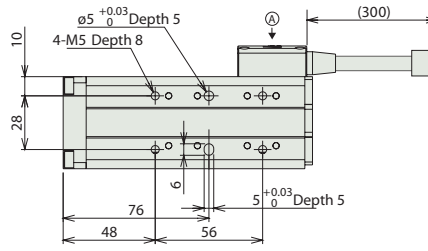

Dimensions and Weight by Stroke

Stroke	50	75
L	130	155
L1	126	151
L2	108	133
M	89	105.5
Mass (kg)	1.3	1.5

Compatible Controllers

RCS2 series actuators can be operated with the controllers indicated below. Select the type according to your intended application.

Title	External View	Model	Features	Maximum number of positioning points	Input power	Power-supply capacity	Standard price	Reference Page
Positioner mode		SCON-CA-60I-NP-2-①	Up to 512 positioning points are supported.	512 points	Single-phase 100 VAC Single-phase 200 VAC 3-phase 200 VAC (XSEL-P/Q only)	218 VA max. *Varies depending on the controller. Refer to the operation manual for details.	-	→ P157
Solenoid mode			Can be operated with the same controls used for solenoid valves.	7 points				
Pulse-train input control mode			Can be controlled using pulse trains.	(-)				
Network mode			Can be moved by direct numerical specification.	768 points				
Program control type, 1 or 2 axes		SSEL-C-1-60I-NP-2-①	Program operation is supported. Up to two axes can be operated.	20000 points				See the ROBO Cylinder general catalog
Program control type, 1 to 6 axes		XSEL-①-1-60I-N1-EEE-2-3	Program operation is supported. Up to six axes can be operated.	20000 points				

* The values of SSEL and XSEL assume a 1-axis specification.
 * ① indicates the type of power-supply voltage (1: 100 V/2: Single-phase 200 V).
 * ① indicates the XSEL type (P/Q).

RCA2-TWA3NA

ROBO Cylinder Mini Table Type Short-Length Wide Type Actuator Width 50 mm 24V Servo Motor
Ball Screw Specification/Lead Screw Specification

Model Description	RCA2	TWA3NA	I	10					
	Series	Type	Encoder type	Motor type	Lead	Stroke	Compatible controllers	Cable length	Option
			I: Incremental specification * Model number is "I" when used with simple absolute unit.	10: Servo motor 10W	4: Ball screw 4mm 2: Ball screw 2mm 1: Ball screw 1mm 4S: Lead screw 4mm 2S: Lead screw 2mm 1S: Lead screw 1mm	30: 30mm 50: 50mm	A1: ACON RACON ASEL A3: AMEC ASEP	N: None P: 1 m S: 3 m M: 5 m X□□: Length Designation	K2: Connector cable exits from the front LA: Power-saving specification

* See page 14 for details on the model descriptions.

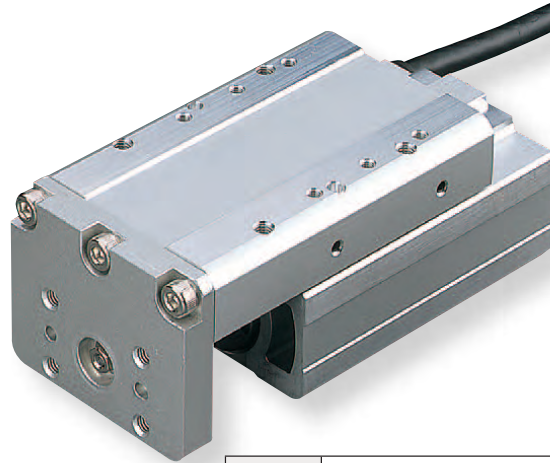

Power-saving specification

- POINT**
Notes on selection
- (1) The payload is the value when the actuator is operated at an acceleration of 0.3 G (0.2G for lead 1, if used vertically and for lead screw specification). The acceleration limit is the value indicated above.
 - (2) If the actuator is used vertically, pay attention to rod contact because the rod will come down when the power is turned off.

Actuator Specifications Table

Leads and Payloads

Model	Motor output (W)	Feed screw	Lead (mm)	Maximum payload		Rated thrust (N)	Positioning repeatability (mm)	Stroke (mm)
				Horizontal (kg)	Vertical (kg)			
RCA2-TWA3NA-I-10-4-①-②-③-④	10	Ball screw	4	0.75	0.25	42.7	±0.02	30 50
RCA2-TWA3NA-I-10-2-①-②-③-④			2	1.5	0.5	85.5		
RCA2-TWA3NA-I-10-1-①-②-③-④			1	3	1	170.9		
RCA2-TWA3NA-I-10-4S-①-②-③-④	10	Lead screw	4	0.25	0.125	25.1	±0.05	30 50
RCA2-TWA3NA-I-10-2S-①-②-③-④			2	0.5	0.25	50.3		
RCA2-TWA3NA-I-10-1S-①-②-③-④			1	1	0.5	100.5		

Stroke and Maximum Speed

Lead	Stroke	Maximum Speed	
		30 (mm)	50 (mm)
Ball screw	4	200	
	2	100	
	1	50	
Lead screw	4	200	
	2	100	
	1	50	

Legend ① Stroke ② Compatible Controllers ③ Cable length ④ Option (unit: mm/s)

① Stroke list

Stroke (mm)	Standard price	
	Ball screw	Lead screw
30	—	—
50	—	—

③ Cable Length

Type	Cable symbol	Standard price
Standard type (Robot cable)	P (1m)	—
	S (3m)	—
	M (5m)	—
Special length	X06 (6m) ~ X10 (10m)	—
	X11 (11m) ~ X15 (15m)	—
	X16 (16m) ~ X20 (20m)	—

* The standard cable for the RCA2 is the robot cable.

④ Options

Title	Option code	See page	Standard price
Connector cable exits from the front	K2	—	—
Power-saving specification	LA	—	—

Actuator Specifications

Item	Description
Drive System	Ball screw/Lead screw, ø4mm, rolled C10
Lost motion	Ball screw: 0.1mm or less Lead screw: 0.3 mm or less
Frame	Material: Aluminum, white alumite treated
Dynamic allowable moment (see note)	Ma: 9.9 N·m Mb: 9.9 N·m Mc: 9.4 N·m
Ambient operating temperature, humidity	0 to 40°C, 85% RH or less (Non-condensing)
Service life	Lead screw specification
	Ball screw specification
	Horizontal specification: 10 million cycles, Vertical specification: 5 million cycles 5,000 km or 50 million cycles (*)

(Note) For cases when the guide service life has been set to 5,000km.

(*) For lead 1: 3,000 km or 50 million cycles

Dimensional Drawings

- *1 Connect the motor and encoder cables.
- *2 During home return, be careful to avoid interference from peripheral objects because the rod travels until the mechanical end.

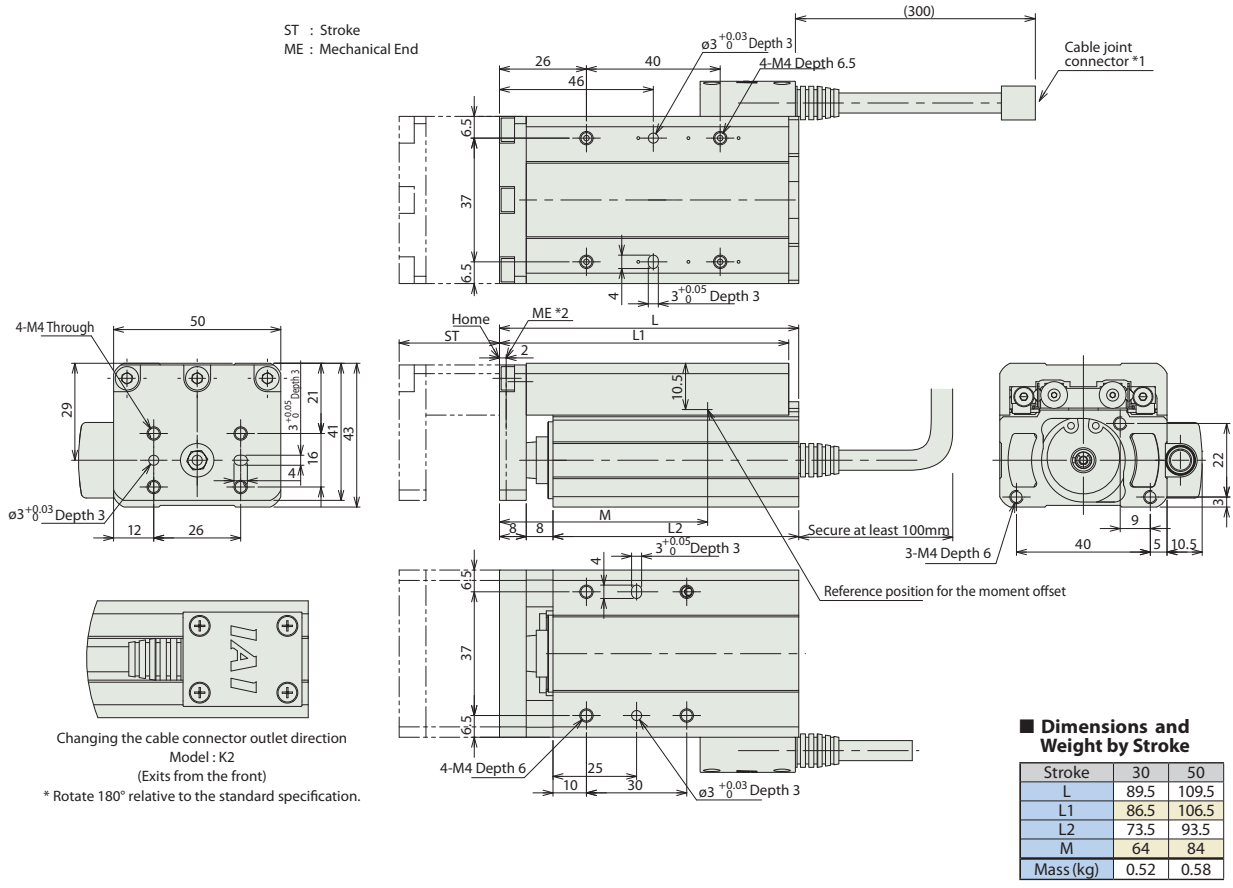

Compatible Controllers

RCA2 series actuators can be operated with the controllers indicated below. Select the type according to your intended application.

Title	External View	Model	Features	Maximum number of positioning points	Input power	Power-supply capacity	Standard price	Reference Page	
Solenoid valve type		AMEC-C-10①-NP-2-1	Easy-to-use controller, even for beginners	3 points	DC24V	Rated: 2.4A (Standard specification) Rated: 1.3A Maximum: 4.4 A (Power-saving specification) Rated: 1.3A Maximum: 2.5A	-	→ P131	
Splash-proof solenoid valve type		ASEP-C-10①-NP-2-0	Operable with the same signal as a solenoid valve. Supports both single and double solenoid types. No homing necessary with the simple absolute type.					→ P141	
Positioner type		ACON-C-10①-NP-2-0	Up to 512 positioning points are supported.	512 points				-	See the ROBO Cylinder general catalog
Safety-compliant positioner type		ACON-CG-10①-NP-2-0						-	
Pulse-train input type (Differential line driver)		ACON-PL-10①-NP-2-0	Pulse-train input type with differential line driver support	(-)				-	
Pulse-train input type (Open collector)		ACON-PO-10①-NP-2-0	Pulse-train input type with open collector support					-	
Serial communication type		ACON-SE-10①-N-0-0	Dedicated to serial communication	64 points				-	
Field network type		RACON-10①	Dedicated to a field network	768 points				-	
Program control type		ASEL-C-1-10①-NP-2-0	Program operation is supported. Up to two axes can be operated.	1500 points	-				

* This is for the single-axis ASEL
* Enter the code "LA" in ① when the power-saving specification is specified.

Mini Slider type
Mini Rod type
Mini Table type
Mini Servo type
Controller
Compact
Wide
Flat
Coupling
Side-mounted

RCA2-TWA4NA

ROBO Cylinder Mini Table Type Short-Length Wide Type Actuator Width 58 mm 24V Servo Motor
Ball Screw Specification/Lead Screw Specification

Model Description	RCA2	TWA4NA	I	20					
Series	Type	Encoder type	Motor type	Lead	Stroke	Compatible controllers	Cable length	Option	
I: Incremental specification * Model number is "I" when used with simple absolute unit.	20: Servo motor 20W	6: Ball screw 6mm 4: Ball screw 4mm 2: Ball screw 2mm 6S: Lead screw 6mm 4S: Lead screw 4mm 2S: Lead screw 2mm		30: 30mm 50: 50mm	A1: ACON RACON ASEL A3: AMEC ASEP	N: None P: 1 m S: 3 m M: 5 m X□□: Length Designation	K2: Connector cable exits from the front LA: Power-saving specification		

* See page 14 for details on the model descriptions.

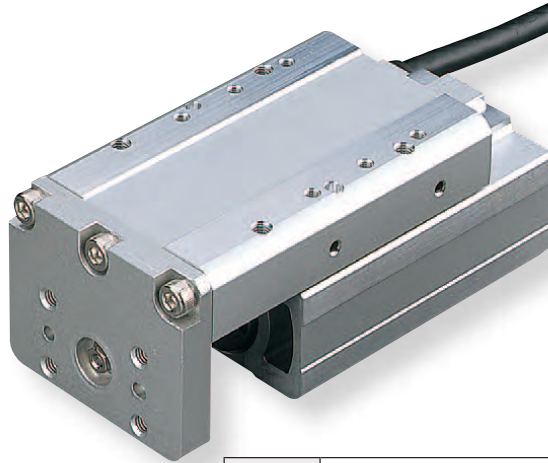

Power-saving specification



- (1) The payload is the value when the actuator is operated at an acceleration of 0.3 G (0.2G for lead 2, if used vertically and for lead screw specification). The acceleration limit is the value indicated above.
- (2) If the actuator is used vertically, pay attention to rod contact because the rod will come down when the power is turned off.

Actuator Specifications Table

Leads and Payloads

Model	Motor output (W)	Feed screw	Lead (mm)	Maximum payload		Rated thrust (N)	Positioning repeatability (mm)	Stroke (mm)
				Horizontal (kg)	Vertical (kg)			
RCA2-TWA4NA-I-20-6-①-②-③-④	20	Ball screw	6	2	0.5	33.8	±0.02	30 50
RCA2-TWA4NA-I-20-4-①-②-③-④			4	3	0.75	50.7		
RCA2-TWA4NA-I-20-2-①-②-③-④			2	6	1.5	101.5		
RCA2-TWA4NA-I-20-6S-①-②-③-④	20	Lead screw	6	0.25	0.125	19.9	±0.05	30 50
RCA2-TWA4NA-I-20-4S-①-②-③-④			4	0.5	0.25	29.8		
RCA2-TWA4NA-I-20-2S-①-②-③-④			2	1	0.5	59.7		

Legend ① Stroke ② Compatible Controllers ③ Cable length ④ Option

Stroke and Maximum Speed

Lead	Stroke	30 (mm)		50 (mm)	
		Ball screw	Lead screw	Ball screw	Lead screw
Ball screw	6	270 <220>	300		
	4	200			
	2	100			
Lead screw	6	220	300		
	4	200			
	2	100			

* < > Indicates vertical use (unit: mm/s)

① Stroke list

Stroke (mm)	Standard price	
	Ball screw	Lead screw
30	—	—
50	—	—

④ Options

Title	Option code	See page	Standard price
Connector cable exits from the front	K2	—	—
Power-saving specification	LA	—	—

③ Cable Length

Type	Cable symbol	Standard price
Standard type (Robot cable)	P (1m)	—
	S (3m)	—
	M (5m)	—
Special length	X06 (6m) ~ X10 (10m)	—
	X11 (11m) ~ X15 (15m)	—
	X16 (16m) ~ X20 (20m)	—

* The standard cable for the RCA2 is the robot cable.

Actuator Specifications

Item	Description
Drive System	Ball screw/Lead screw, ø6mm, rolled C10
Lost motion	Ball screw: 0.1mm or less Lead screw: 0.3 mm or less
Frame	Material: Aluminum, white alumite treated
Dynamic allowable moment (see note)	Ma: 9.9 N·m Mb: 9.9 N·m Mc: 12.2 N·m
Ambient operating temperature, humidity	0 to 40°C, 85% RH or less (Non-condensing)
Service life	Lead screw specification
	Ball screw specification
	Horizontal specification: 10 million cycles, Vertical specification: 5 million cycles 5,000 km or 50 million cycles

(Note) For cases when the guide service life has been set to 5,000km.

Dimensional Drawings

- *1 Connect the motor and encoder cables.
- *2 During home return, be careful to avoid interference from peripheral objects because the rod travels until the mechanical end.

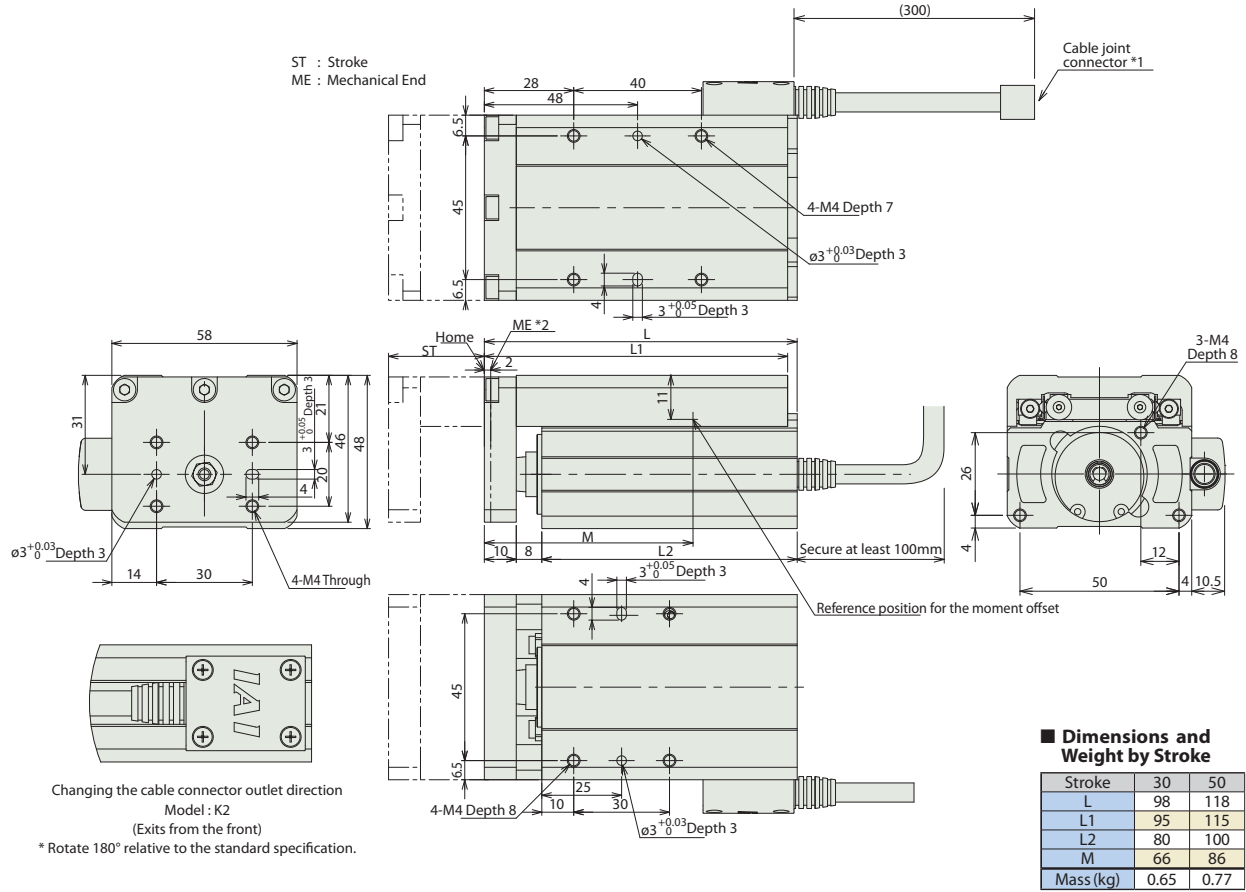

Compatible Controllers

RCA2 series actuators can be operated with the controllers indicated below. Select the type according to your intended application.

Title	External View	Model	Features	Maximum number of positioning points	Input power	Power-supply capacity	Standard price	Reference Page	
Solenoid valve type		AMEC-C-20①-NP-2-1	Easy-to-use controller, even for beginners	3 points	DC24V	(Standard specification) Rated: 2.4A Maximum: 4.4 A (Power-saving specification) Rated: 1.3A Maximum: 2.5A	-	→ P131	
	Splash-proof solenoid valve type		ASEP-C-20①-NP-2-0					Operable with the same signal as a solenoid valve. Supports both single and double solenoid types. No homing necessary with the simple absolute type.	→ P141
Positioner type			ACON-C-20①-NP-2-0	Up to 512 positioning points are supported.				512 points	-
	Safety-compliant positioner type		ACON-CG-20①-NP-2-0						-
Pulse-train input type (Differential line driver)		ACON-PL-20①-NP-2-0	Pulse-train input type with differential line driver support	(-)				-	
Pulse-train input type (Open collector)		ACON-PO-20①-NP-2-0	Pulse-train input type with open collector support					-	
Serial communication type		ACON-SE-20①-N-0-0	Dedicated to serial communication	64 points				-	
Field network type		RACON-20①	Dedicated to a field network	768 points				-	
Program control type		ASEL-C-1-10①-NP-2-0	Program operation is supported. Up to two axes can be operated.	1500 points	-				

* This is for the single-axis ASEL
* Enter the code "LA" in ① when the power-saving specification is specified.

Mini Slider type
Mini Rod type
Mini Table type
Mini Servo type
Controller
Compact
Wide
Flat
Coupling
Side-mounted

RCS2-TWA5N

ROBO Cylinder Mini Table Type Short-Length Wide Type Actuator Width 80 mm 200V Servo Motor Ball Screw Specification

Model Description	RCS2 — TWA5N — I — 60 — <input type="checkbox"/> — <input type="checkbox"/> — T2 — <input type="checkbox"/> — <input type="checkbox"/>							
Series	Type	Encoder type	Motor type	Lead	Stroke	Compatible controllers	Cable length	Option
I: Incremental specification	60: Servo motor 60W	10: 10mm 5: 5mm 2.5: 2.5mm	50: 50mm 75: 75mm	T2: SCION-CA SSEL XSEL-P/Q	N: None P: 1 m S: 3 m M: 5 m X <input type="checkbox"/> : Length Designation R <input type="checkbox"/> : Robot cable	K1: Connector cable exits from the left K2: Connector cable exits from the front K3: Connector cable exits from the right		

* See page 14 for details on the model descriptions.



- (1) The payload is the value when the actuator is operated at an acceleration of 0.3 G (0.2G for lead 2.5) horizontally and 0.2G vertically. The acceleration limit is the value indicated above.
- (2) If the actuator is used vertically, pay attention to rod contact because the rod will come down when the power is turned off.

Actuator Specifications Table

Leads and Payloads

Model	Motor output (W)	Feed screw	Lead (mm)	Maximum payload		Rated thrust (N)	Positioning repeatability (mm)	Stroke (mm)
				Horizontal (kg)	Vertical (kg)			
RCS2-TWA5N-I-60-10- <input type="checkbox"/> -T2- <input type="checkbox"/> - <input type="checkbox"/>	60	Ball screw	10	5	1.5	89	±0.02	50 75
RCS2-TWA5N-I-60-5- <input type="checkbox"/> -T2- <input type="checkbox"/> - <input type="checkbox"/>			5	10	3	178		
RCS2-TWA5N-I-60-2.5- <input type="checkbox"/> -T2- <input type="checkbox"/> - <input type="checkbox"/>			2.5	20	6	356		

Legend Stroke Cable length Option

Stroke and Maximum Speed

Lead	Stroke	50 (mm)	75 (mm)
	10	280 <230>	3 80 <330>
5	250 <230>	250	
2.5	125		

* <> Indicates vertical use (unit: mm/s)

① Stroke list

Stroke (mm)	Standard price
50	—
75	—

② Cable Length

Type	Cable symbol	Standard price
Standard type	P (1m)	—
	S (3m)	—
	M (5m)	—
Special length	X06 (6m) ~ X10 (10m)	—
	X11 (11m) ~ X15 (15m)	—
	X16 (16m) ~ X20 (20m)	—
Robot cable	R01 (1m) ~ R03 (3m)	—
	R04 (4m) ~ R05 (5m)	—
	R06 (6m) ~ R10 (10m)	—
	R11 (11m) ~ R15 (15m)	—
	R16 (16m) ~ R20 (20m)	—

③ Options

Title	Option code	See page	Standard price
Connector cable exits from the left	K1	Refer to the next page	—
Connector cable exits from the front	K2	Refer to the next page	—
Connector cable exits from the right	K3	Refer to the next page	—

Actuator Specifications

Item	Description
Drive System	Ball screw, ø8mm, rolled C10
Lost motion	0.1mm or less
Frame	Material: Aluminum, white alumite treated
Dynamic allowable moment (see note)	Ma: 15 N·m Mb: 15 N·m Mc: 25.5 N·m
Ambient operating temperature, humidity	0 to 40°C, 85% RH or less (Non-condensing)
Service life	5,000 km or 50 million cycles

(Note) For cases when the guide service life has been set to 5,000km.

Dimensional Drawings

- *1 Connect the motor and encoder cables.
- *2 During home return, be careful to avoid interference from peripheral objects because the rod travels until the mechanical end.
ME: Mechanical end SE: Stroke end

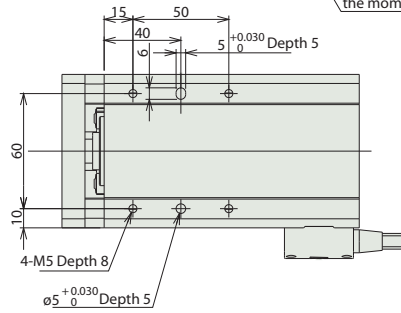
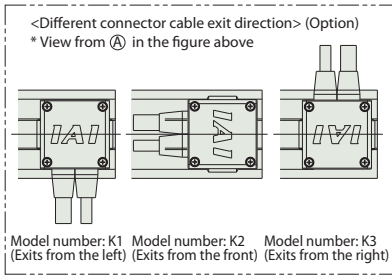
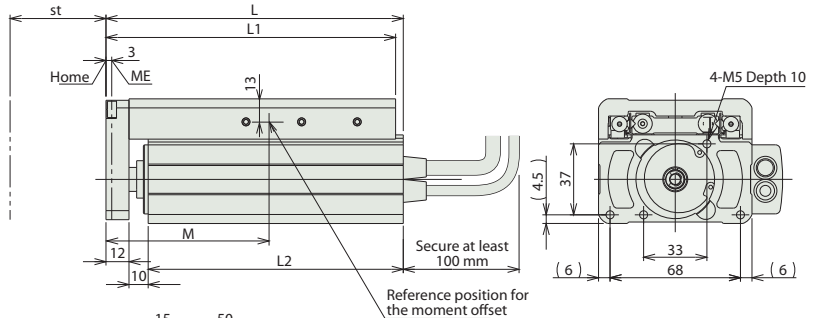
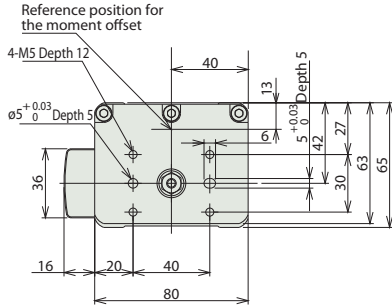
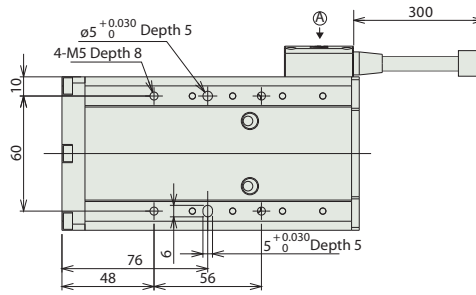

Dimensions and Weight by Stroke

Stroke	50	75
L	130	155
L1	126	151
L2	108	133
M	89	105.5
Mass (kg)	1.7	2.0

Compatible Controllers

RCS2 series actuators can be operated with the controllers indicated below. Select the type according to your intended application.

Title	External View	Model	Features	Maximum number of positioning points	Input power	Power-supply capacity	Standard price	Reference Page
Positioner mode		SCON-CA-60I-NP-2-①	Up to 512 positioning points are supported.	512 points	Single-phase 100 VAC Single-phase 200 VAC 3-phase 200 VAC (XSEL-P/Q only)	218 VA max. *Varies depending on the controller. Refer to the operation manual for details.	-	→ P157
Solenoid mode			Can be operated with the same controls used for solenoid valves.	7 points				
Pulse-train input control mode			Can be controlled using pulse trains.	(-)				
Network mode			Can be moved by direct numerical specification.	768 points				
Program control type, 1 or 2 axes		SSEL-C-1-60I-NP-2-①	Program operation is supported. Up to two axes can be operated.	20000 points			-	See the ROBO Cylinder general catalog
Program control type, 1 to 6 axes		XSEL-①-1-60I-N1-EEE-2-3	Program operation is supported. Up to six axes can be operated.	20000 points			-	

* The values of SSEL and XSEL assume a 1-axis specification.
 * ① indicates the type of power-supply voltage (1: 100 V/2: Single-phase 200 V).
 * ① indicates the XSEL type (P/Q).

- Mini Slider type
- Mini Rod type
- Mini Table type
- Mini Linear Servo type
- Controller
- Compact
- Wide
- Flat
- Coupling
- Side-mounted

RCA2-TFA3NA

ROBO Cylinder Mini Table Type Short-Length Flat Type Actuator Width 61 mm 24V Servo Motor
Ball Screw Specification/Lead Screw Specification

Model Description	RCA2 — TFA3NA — I — 10 — <input type="checkbox"/> — <input type="checkbox"/> — <input type="checkbox"/> — <input type="checkbox"/> — <input type="checkbox"/>							
Series	Type	Encoder type	Motor type	Lead	Stroke	Compatible controllers	Cable length	Option
I: Incremental specification * Model number is "I" when used with simple absolute unit.	10: Servo motor 10W	4: Ball screw 4mm 2: Ball screw 2mm 1: Ball screw 1mm 4S: Lead screw 4mm 2S: Lead screw 2mm 1S: Lead screw 1mm	30: 30mm 50: 50mm	A1: ACON RACON ASEL A3: AMEC ASEP	N: None P: 1 m S: 3 m M: 5 m X□□: Length Designation	K2: Connector cable exits from the front LA: Power-saving specification		

* See page 14 for details on the model descriptions.

Power-saving specification

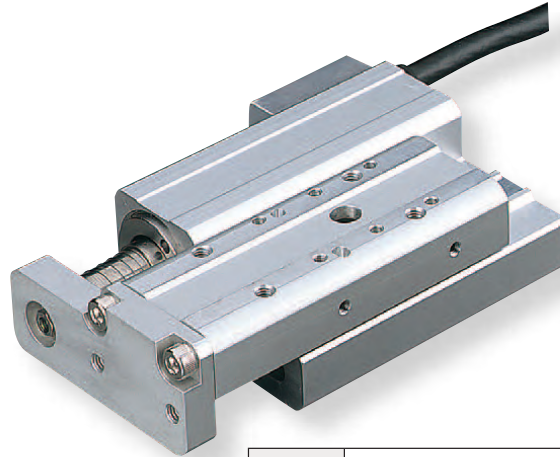

- POINT**
Notes on selection
- (1) The payload is the value when the actuator is operated at an acceleration of 0.3 G (0.2G for lead 1, if used vertically and for lead screw specification). The acceleration limit is the value indicated above.
 - (2) If the actuator is used vertically, pay attention to rod contact because the rod will come down when the power is turned off.

Actuator Specifications Table

Leads and Payloads

Model	Motor output (W)	Feed screw	Lead (mm)	Maximum payload		Rated thrust (N)	Positioning repeatability (mm)	Stroke (mm)
				Horizontal (kg)	Vertical (kg)			
RCA2-TFA3NA-I-10-4-①-②-③-④	10	Ball screw	4	0.75	0.25	42.7	±0.02	30 50
RCA2-TFA3NA-I-10-2-①-②-③-④			2	1.5	0.5	85.5		
RCA2-TFA3NA-I-10-1-①-②-③-④			1	3	1	170.9		
RCA2-TFA3NA-I-10-4S-①-②-③-④	10	Lead screw	4	0.25	0.125	25.1	±0.05	30 50
RCA2-TFA3NA-I-10-2S-①-②-③-④			2	0.5	0.25	50.3		
RCA2-TFA3NA-I-10-1S-①-②-③-④			1	1	0.5	100.5		

Stroke and Maximum Speed

Lead	Stroke	Maximum Speed	
		30 (mm)	50 (mm)
Ball screw	4	200	
	2	100	
	1	50	
Lead screw	4	200	
	2	100	
	1	50	

(unit: mm/s)

Legend ① Stroke ② Compatible Controllers ③ Cable length ④ Option

① Stroke list

Stroke (mm)	Standard price	
	Feed screw	
	Ball screw	Lead screw
30	—	—
50	—	—

③ Cable Length

Type	Cable symbol	Standard price
Standard type (Robot cable)	P (1m)	—
	S (3m)	—
	M (5m)	—
Special length	X06 (6m) ~ X10 (10m)	—
	X11 (11m) ~ X15 (15m)	—
	X16 (16m) ~ X20 (20m)	—

* The standard cable for the RCA2 is the robot cable.

④ Options

Title	Option code	See page	Standard price
Connector cable exits from the front	K2	—	—
Power-saving specification	LA	—	—

Actuator Specifications

Item	Description
Drive System	Ball screw/Lead screw, ø4mm, rolled C10
Lost motion	Ball screw: 0.1mm or less Lead screw: 0.3 mm or less
Frame	Material: Aluminum, white alumite treated
Dynamic allowable moment (see note)	Ma: 9.9 N·m Mb: 9.9 N·m Mc: 3.3 N·m
Ambient operating temperature, humidity	0 to 40°C, 85% RH or less (Non-condensing)
Service life	Lead screw specification
	Ball screw specification
	Horizontal specification: 10 million cycles, Vertical specification: 5 million cycles 5,000 km or 50 million cycles (*)

(Note) For cases when the guide service life has been set to 5,000km.

(*) For lead 1: 3,000 km or 50 million cycles

RCA2-TFA4NA

ROBO Cylinder Mini Table Type Short-Length Flat Type Actuator Width 71 mm 24V Servo Motor Ball Screw Specification/Lead Screw Specification

Model Description	RCA2 — TFA4NA — I — 20 — <input type="checkbox"/> — <input type="checkbox"/> — <input type="checkbox"/> — <input type="checkbox"/> — <input type="checkbox"/>							
Series	Type	Encoder type	Motor type	Lead	Stroke	Compatible controllers	Cable length	Option
I: Incremental specification * Model number is "I" when used with simple absolute unit.	20: Servo motor 20W	6: Ball screw 6mm 4: Ball screw 4mm 2: Ball screw 2mm 6S: Lead screw 6mm 4S: Lead screw 4mm 2S: Lead screw 2mm	30: 30mm 50: 50mm	A1: ACON RACON ASEL A3: AMEC ASEP	N: None P: 1 m S: 3 m M: 5 m X□□: Length Designation	K2: Connector cable exits from the front LA: Power-saving specification		

* See page 14 for details on the model descriptions.

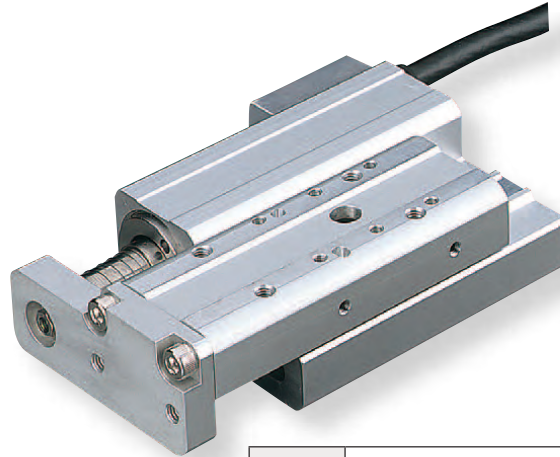

Power-saving specification

- POINT**
Notes on selection
- (1) The payload is the value when the actuator is operated at an acceleration of 0.3 G (0.2G for lead 2, if used vertically and for lead screw specification). The acceleration limit is the value indicated above.
 - (2) If the actuator is used vertically, pay attention to rod contact because the rod will come down when the power is turned off.

Actuator Specifications Table

Leads and Payloads

Model	Motor output (W)	Feed screw	Lead (mm)	Maximum payload		Rated thrust (N)	Positioning repeatability (mm)	Stroke (mm)
				Horizontal (kg)	Vertical (kg)			
RCA2-TFA4NA-I-20-6-①-②-③-④	20	Ball screw	6	2	0.5	33.8	±0.02	30 50
RCA2-TFA4NA-I-20-4-①-②-③-④			4	3	0.75	50.7		
RCA2-TFA4NA-I-20-2-①-②-③-④			2	6	1.5	101.5		
RCA2-TFA4NA-I-20-6S-①-②-③-④	20	Lead screw	6	0.25	0.125	19.9	±0.05	30 50
RCA2-TFA4NA-I-20-4S-①-②-③-④			4	0.5	0.25	29.8		
RCA2-TFA4NA-I-20-2S-①-②-③-④			2	1	0.5	59.7		

Stroke and Maximum Speed

Lead	Stroke	30 (mm)		50 (mm)	
		Ball screw	Lead screw	Ball screw	Lead screw
Ball screw	6	270 <220>	300		
	4	200			
	2	100			
Lead screw	6	220	300		
	4	200			
	2	100			

Legend ① Stroke ② Compatible Controllers ③ Cable length ④ Option

* <> Indicates vertical use (unit: mm/s)

① Stroke list

Stroke (mm)	Standard price	
	Feed screw	
	Ball screw	Lead screw
30	—	—
50	—	—

③ Cable Length

Type	Cable symbol	Standard price
Standard type (Robot cable)	P (1m)	—
	S (3m)	—
	M (5m)	—
Special length	X06 (6m) ~ X10 (10m)	—
	X11 (11m) ~ X15 (15m)	—
	X16 (16m) ~ X20 (20m)	—

* The standard cable for the RCA2 is the robot cable.

④ Options

Title	Option code	See page	Standard price
Connector cable exits from the front	K2	—	—
Power-saving specification	LA	—	—

Actuator Specifications

Item	Description
Drive System	Ball screw/Lead screw, ø6mm, rolled C10
Lost motion	Ball screw: 0.1mm or less Lead screw: 0.3 mm or less
Frame	Material: Aluminum, white alumite treated
Dynamic allowable moment (see note)	Ma: 9.9 N·m Mb: 9.9 N·m Mc: 3.3 N·m
Ambient operating temperature, humidity	0 to 40°C, 85% RH or less (Non-condensing)
Service life	Lead screw specification
	Ball screw specification
	Horizontal specification: 10 million cycles, Vertical specification: 5 million cycles 5,000 km or 50 million cycles

(Note) For cases when the guide service life has been set to 5,000km.

RCS2-TFA5N

ROBO Cylinder Mini Rod Type Short-Length Flat Type Actuator Width 95 mm 200 V Servo Motor Ball Screw Specification

Model Description	RCS2 — TFA5N — I — 60 — <input type="checkbox"/> — <input type="checkbox"/> — T2 — <input type="checkbox"/> — <input type="checkbox"/>							
Series	Type	Encoder type	Motor type	Lead	Stroke	Compatible controllers	Cable length	Option
I: Incremental specification	60: Servo motor 60W	10: 10mm 5: 5mm 2.5: 2.5mm	50: 50mm 75: 75mm	T2: SCON-CA SSEL XSEL-P/Q	N: None P: 1 m S: 3 m M: 5 m X <input type="checkbox"/> : Length Designation R <input type="checkbox"/> : Robot cable	K1: Connector cable exits from the left K2: Connector cable exits from the front K3: Connector cable exits from the right		

* See page 14 for details on the model descriptions.



- (1) The payload is the value when the actuator is operated at an acceleration of 0.3 G (0.2G for lead 2.5) horizontally and 0.2G vertically. The acceleration limit is the value indicated above.
- (2) If the actuator is used vertically, pay attention to rod contact because the rod will come down when the power is turned off.

Actuator Specifications Table

Leads and Payloads

Model	Motor output (W)	Feed screw	Lead (mm)	Maximum payload		Rated thrust (N)	Positioning repeatability (mm)	Stroke (mm)
				Horizontal (kg)	Vertical (kg)			
RCS2-TFA5N-I-60-10- <input type="checkbox"/> -T2- <input type="checkbox"/> - <input type="checkbox"/>	60	Ball screw	10	5	1.5	89	±0.02	50 75
RCS2-TFA5N-I-60-5- <input type="checkbox"/> -T2- <input type="checkbox"/> - <input type="checkbox"/>			5	10	3	178		
RCS2-TFA5N-I-60-2.5- <input type="checkbox"/> -T2- <input type="checkbox"/> - <input type="checkbox"/>			2.5	20	6	356		

Legend Stroke Cable length Option

Stroke and Maximum Speed

Lead	Stroke	50 (mm)	75 (mm)
	10	280 <230>	380 <330>
5	250 <230>	250	
2.5	125		

* <> Indicates vertical use (unit: mm/s)

① Stroke list

Stroke (mm)	Standard price
50	—
75	—

② Cable Length

Type	Cable symbol	Standard price
Standard type	P (1m)	—
	S (3m)	—
	M (5m)	—
Special length	X06 (6m) ~ X10 (10m)	—
	X11 (11m) ~ X15 (15m)	—
	X16 (16m) ~ X20 (20m)	—
Robot cable	R01 (1m) ~ R03 (3m)	—
	R04 (4m) ~ R05 (5m)	—
	R06 (6m) ~ R10 (10m)	—
	R11 (11m) ~ R15 (15m)	—
	R16 (16m) ~ R20 (20m)	—

③ Options

Title	Option code	See page	Standard price
Connector cable exits from the left	K1	Refer to the next page	—
Connector cable exits from the front	K2	Refer to the next page	—
Connector cable exits from the right	K3	Refer to the next page	—

Actuator Specifications

Item	Description
Drive System	Ball screw, ø8mm, rolled C10
Lost motion	0.1mm or less
Frame	Material: Aluminum, white alumite treated
Dynamic allowable moment (see note)	Ma: 15 N·m Mb: 15 N·m Mc: 7.1 N·m
Ambient operating temperature, humidity	0 to 40°C, 85% RH or less (Non-condensing)
Service life	5,000 km or 50 million cycles

(Note) For cases when the guide service life has been set to 5,000km.

Dimensional Drawings

- *1 Connect the motor and encoder cables.
- *2 During home return, be careful to avoid interference from peripheral objects because the rod travels until the mechanical end.
ME: Mechanical end SE: Stroke end

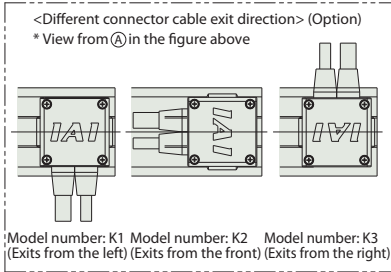
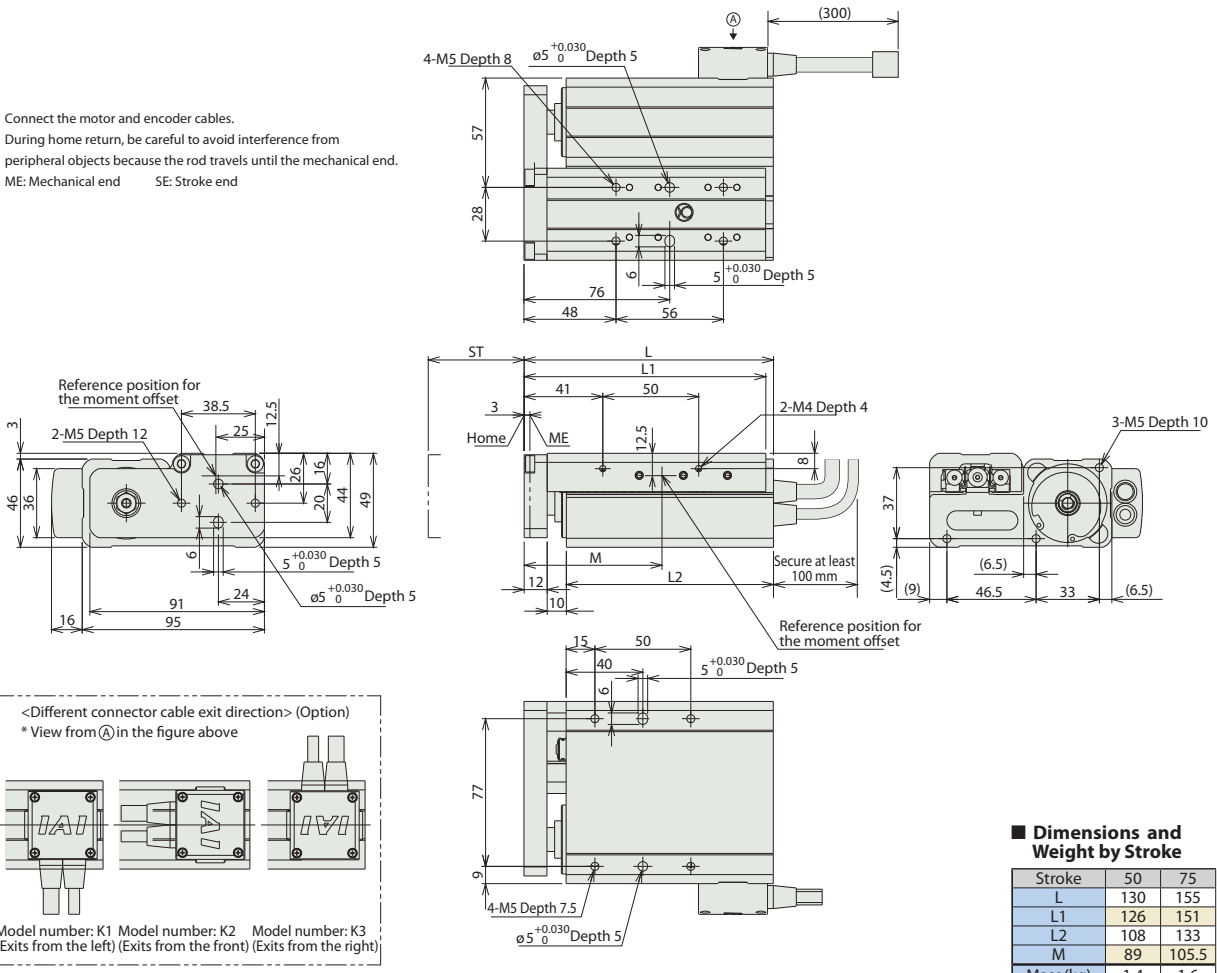

Compatible Controllers

RCS2 series actuators can be operated with the controllers indicated below. Select the type according to your intended application.

Title	External View	Model	Features	Maximum number of positioning points	Input power	Power-supply capacity	Standard price	Reference Page
Positioner mode		SCON-CA-60I-NP-2-①	Up to 512 positioning points are supported.	512 points	Single-phase 100 VAC Single-phase 200 VAC 3-phase 200 VAC (XSEL-P/Q only)	218 VA max. *Varies depending on the controller. Refer to the operation manual for details.	-	→ P157
Solenoid mode			Can be operated with the same controls used for solenoid valves.	7 points				
Pulse-train input control mode			Can be controlled using pulse trains.	(-)				
Network mode			Can be moved by direct numerical specification.	768 points				
Program control type, 1 or 2 axes		SSEL-C-1-60I-NP-2-①	Program operation is supported. Up to two axes can be operated.	20000 points			-	See the ROBO Cylinder general catalog
Program control type, 1 to 6 axes		XSEL-①-1-60I-N1-EEE-2-3	Program operation is supported. Up to six axes can be operated.	20000 points			-	

* The values of SSEL and XSEL assume a 1-axis specification.
* ① indicates the type of power-supply voltage (1: 100 V/2: Single-phase 200 V).
* ② indicates the XSEL type (P/Q).



RCP3-TA3C

ROBO Cylinder Mini Table Type Motor Unit Coupling Type Actuator Width 36 mm Pulse Motor Ball Screw Specification

Model Description	RCP3 — TA3C — I — 20P — <input type="checkbox"/> — <input type="checkbox"/> — <input type="checkbox"/> — <input type="checkbox"/> — <input type="checkbox"/>							
Series	Type	Encoder type	Motor type	Lead	Stroke	Compatible controllers	Cable length	Option
		I: Incremental specification * Model number is "I" when used with simple absolute unit.	20P: Pulse motor 20□Size	6: 6mm 4: 4mm 2: 2mm	20: 20mm ? 100: 100mm (set in steps every 10mm)	P1: PCON RPCON PSEL P3: PMEC PSEP	N: None P: 1 m S: 3 m M: 5 m X□□: Length Designation	See option table below.

* See page 14 for details on the model descriptions.



Correlation Diagrams of Speed and Load Capacity
With the RCP3 series, due to the characteristics of the pulse motor, load capacity decreases as the speed increases. Use the chart below to confirm that the desired speed and load capacity requirements are met.

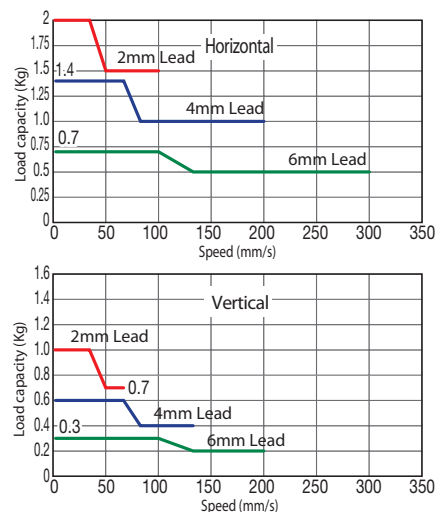

POINT Notes on selection
(1) The payload is the value when operated with acceleration of 0.3G (or 0.2G in the case of Lead 2 and vertical usage). The upper limit for acceleration is 0.3G (or 0.2G in the case of Lead 2 and vertical usage).

Actuator Specifications Table

Model	Feed screw	Lead (mm)	Maximum payload		Rated thrust (N)	Positioning repeatability (mm)	Stroke (mm)
			Horizontal (kg)	Vertical (kg)			
RCP3-TA3C-I-20P-6-①-②-③-④	Ball screw	6	~0.7	~0.3	9	±0.02	20 to 100 (every 10mm)
RCP3-TA3C-I-20P-4-①-②-③-④		4	~1.4	~0.6	14		
RCP3-TA3C-I-20P-2-①-②-③-④		2	~2	~1	28		

Legend ① Stroke ② Compatible Controllers ③ Cable length ④ Option (Note 2) For a graph of the pushing force, see P127. * < > Indicates vertical use (unit: mm/s)

① Stroke list

Stroke (mm)	Standard price
20	—
30	—
40	—
50	—
60	—
70	—
80	—
90	—
100	—

④ Options

Title	Option code	See page	Standard price
Brake	B	—	—
Reversed-home specification	NM	—	—

③ Cable Length

Type	Cable symbol	Standard price
Standard type (Robot cable)	P (1m)	—
	S (3m)	—
	M (5m)	—
Special length	X06 (6m) ~ X10 (10m)	—
	X11 (11m) ~ X15 (15m)	—
	X16 (16m) ~ X20 (20m)	—

* Robot type cable comes as standard with RCP3 actuator.

Actuator Specifications

Item	Description
Drive System	Ball screw, ø6mm, rolled C10
Lost motion	0.1mm or less
Base	Material: Aluminum, white alumite treated
Dynamic allowable moment (Note 3)	Ma: 3.2 N·m Mb: 4.6 N·m Mc: 5.1 N·m
Ambient operating temperature, humidity	0 to 40°C, 85% RH or less (Non-condensing)

(Note 3) For case of 5,000km service life.

Directions of allowable load moments



Dimensional Drawings

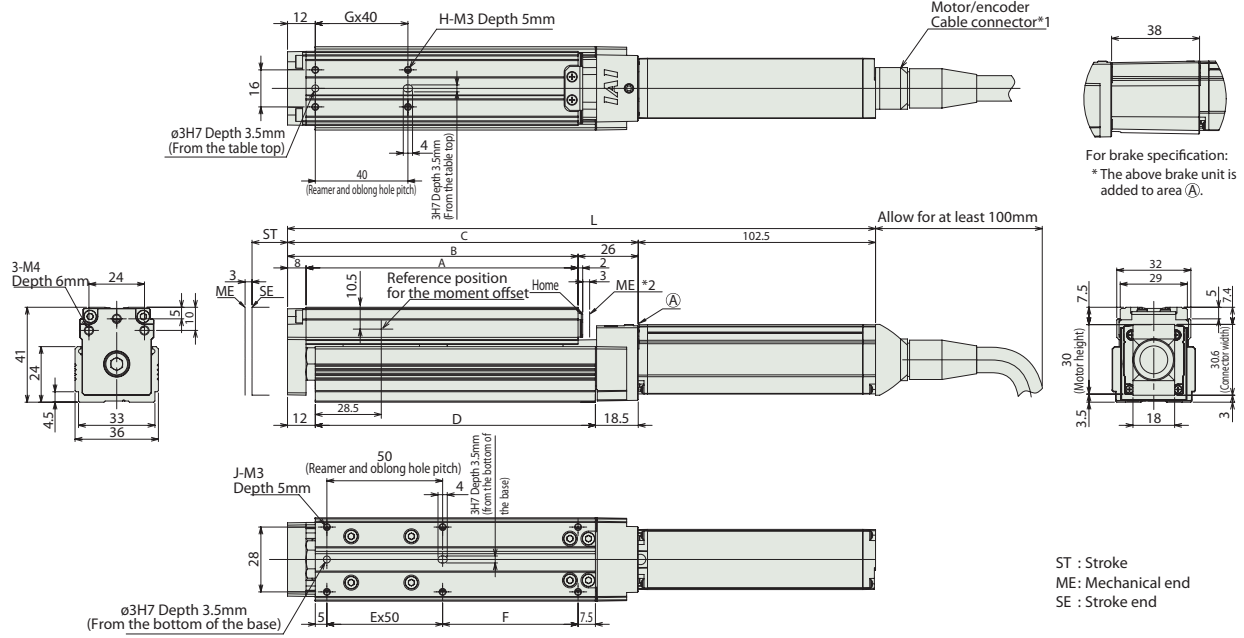

- * 1 The motor-encoder cable is connected directly to the actuator motor cover.
- * 2 The slider moves to the mechanical end during home return. Pay attention to prevent contact between the slider and surrounding parts.

■ Dimensions and Weight by Stroke * The attached brake adds 0.1kg of mass.

Stroke	20	30	40	50	60	70	80	90	100
L No brake	224	234	244	254	264	274	284	294	304
L Brake-equipped	262	272	282	292	302	312	322	332	342
A	87.5	97.5	107.5	117.5	127.5	137.5	147.5	157.7	167.5
B	95.5	105.5	115.1	125.5	135.5	145.5	155.5	165.5	175.5
C	121.5	131.5	141.5	151.5	161.5	171.5	181.5	191.5	201.5
D	91	101	111	121	131	141	151	161	171
E	1	1	1	1	2	2	2	2	2
F	28.5	38.5	48.5	58.5	18.5	28.5	38.5	48.5	58.5
G	1	1	1	1	2	2	2	2	2
H	4	4	4	4	6	6	6	6	6
J	6	6	6	6	8	8	8	8	8
Mass (kg)	0.5	0.5	0.5	0.6	0.6	0.6	0.6	0.7	0.7

② Compatible Controllers

RCP3 series actuators can be operated with the controllers indicated below. Select the type according to your intended application.

Title	External View	Model	Features	Maximum number of positioning points	Input power	Power-supply capacity	Standard price	Reference Page
Solenoid valve type		PMEC-C-20PI-NP-2-①	Easy-to-use controller, even for beginners	3 points	AC100V AC200V	See the ROBO Cylinder general catalog.	-	→ P131
Splash-proof solenoid type		PSEP-C-20PI-NP-2-0	Operable with the same signal as a solenoid valve. Supports both single and double solenoid types. No homing necessary with the simple absolute type.					
Positioner type		PCON-C-20PI-NP-2-0	Up to 512 positioning points are supported.	512 points			-	
Safety-compliant positioner type		PCON-CG-20PI-NP-2-0						
Pulse-train input type (Differential line driver)		PCON-PL-20PI-NP-2-0	Pulse-train input type with differential line driver support	(-)	DC24V	Maximum: 2A	-	See the ROBO Cylinder general catalog
Pulse-train input type (Open collector)		PCON-PO-20PI-NP-2-0	Pulse-train input type with open collector support					
Serial communication type		PCON-SE-20PI-N-0-0	Dedicated to serial communication	64 points			-	
Field network type		RPCON-20P	Dedicated to a field network	768 points			-	
Program control type		PSEL-C-1-20PI-NP-2-0	Program operation is supported. Up to two axes can be operated.	1500 points			-	

* This is for the single-axis PSEL
* ① indicates the power-supply voltage type (1: 100V / 2: 100 to 240V).



RCP3-TA4C

ROBO Cylinder Mini Table Type Motor Unit Coupling Type Actuator Width 40 mm Pulse Motor Ball Screw Specification

Model Description	RCP3	TA4C	I	28P					
	Series	Type	Encoder type	Motor type	Lead	Stroke	Compatible controllers	Cable length	Option
			I: Incremental specification * Model number is "I" when used with simple absolute unit.	28P: Pulse motor 28□Size	6: 6mm 4: 4mm 2: 2mm	20: 20mm ? 100: 100mm (set in steps every 10mm)	P1: PCON RPCON PSEL P3: PMEC PSEP	N: None P: 1 m S: 3 m M: 5 m X□□: Length Designation	See option table below.

* See page 14 for details on the model descriptions.

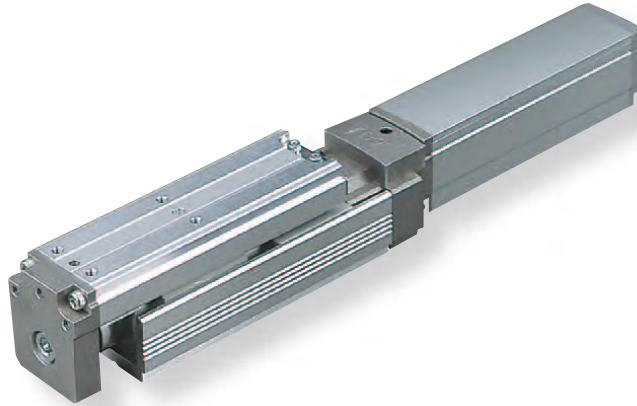

Correlation Diagrams of Speed and Load Capacity
With the RCP3 series, due to the characteristics of the pulse motor, load capacity decreases as the speed increases. Use the chart below to confirm that the desired speed and load capacity requirements are met.

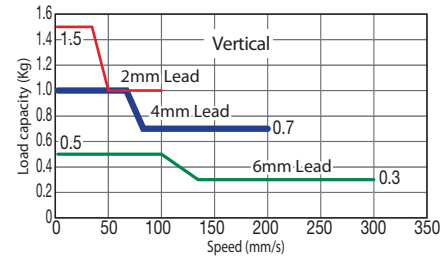
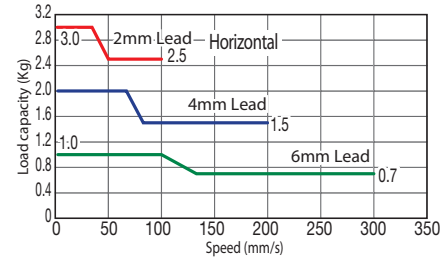

POINT Notes on selection
(1) The payload is the value when operated with acceleration of 0.3G (or 0.2G in the case of Lead 2 and vertical usage). The upper limit for acceleration is 0.3G (or 0.2G in the case of Lead 2 and vertical usage).

Actuator Specifications Table

Leads and Payloads

(Note 1) Please note that the maximum payload decreases as the speed increases.

Model	Feed screw	Lead (mm)	Maximum payload		Rated thrust (N)	Positioning repeatability (mm)	Stroke (mm)
			Horizontal (kg)	Vertical (kg)			
RCP3-TA4C-I-28P-6-①-②-③-④	Ball screw	6	~1	~0.5	15	±0.02	20 to 100 (every 10mm)
RCP3-TA4C-I-28P-4-①-②-③-④		4	~2	~1	22		
RCP3-TA4C-I-28P-2-①-②-③-④		2	~3	~1.5	44		

Stroke and Maximum Speed

Lead	Stroke	
	20 to 100 (mm)	20 to 100 (mm)
Ball screw	6	300
	4	200
	2	100

Legend ① Stroke ② Compatible Controllers ③ Cable length ④ Option

(Note 2) For a graph of the pushing force, see P127.

(unit: mm/s)

① Stroke list

Stroke (mm)	Standard price
20	—
30	—
40	—
50	—
60	—
70	—
80	—
90	—
100	—

④ Options

Title	Option code	See page	Standard price
Brake	B	—	—
Cable exit direction (top)	CJT	—	—
Cable exit direction (right)	CJR		
Cable exit direction (left)	CJL		
Cable exit direction (bottom)	CJB		
Reversed-home specification	NM	—	—

③ Cable Length

Type	Cable symbol	Standard price
Standard type (Robot cable)	P (1m)	—
	S (3m)	—
	M (5m)	—
Special length	X06 (6m) ~ X10 (10m)	—
	X11 (11m) ~ X15 (15m)	—
	X16 (16m) ~ X20 (20m)	—

* Robot type cable comes as standard with RCP3 actuator.

Actuator Specifications

Item	Description
Drive System	Ball screw, ø6mm, rolled C10
Lost motion	0.1mm or less
Base	Material: Aluminum, white alumite treated
Dynamic allowable moment (note 3)	Ma: 4.2 N·m Mb: 6 N·m Mc: 8.2 N·m
Ambient operating temperature, humidity	0 to 40°C, 85% RH or less (Non-condensing)

(Note 3) For case of 5,000km service life.

Directions of allowable load moments

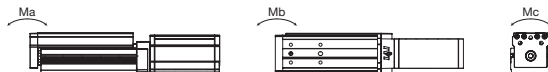

Dimensional Drawings

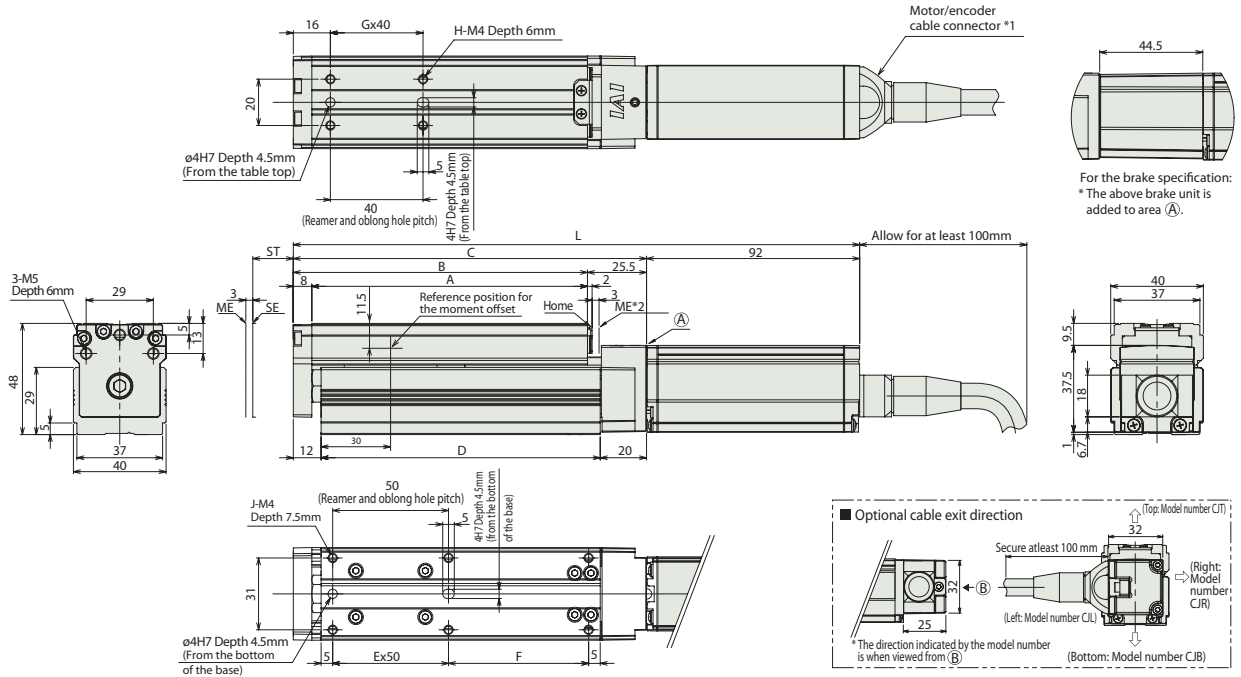

- * 1 The motor-encoder cable is connected directly to the actuator motor cover.
- * 2 The slider moves to the mechanical end during home return. Pay attention to prevent contact between the slider and surrounding parts.

ST : Stroke
ME: Mechanical end
SE : Stroke end

■ Dimensions and Weight by Stroke * The attached brake adds 0.2kg of mass.

Stroke	20	30	40	50	60	70	80	90	100
No brake	214.5	224.5	234.5	244.5	254.5	264.5	274.5	284.5	294.5
Brake-equipped	259	269	279	289	299	309	319	329	339
A	89	99	109	119	129	139	149	159	169
B	97	107	117	127	137	147	157	167	177
C	122.5	132.5	142.5	152.5	162.5	172.5	182.5	192.5	202.5
D	90.5	100.5	110.5	120.5	130.5	140.5	150.5	160.5	170.5
E	1	1	1	1	2	2	2	2	2
F	30.5	40.5	50.5	60.5	20.5	30.5	40.5	50.5	60.5
G	1	1	1	1	2	2	2	2	2
H	4	4	4	4	6	6	6	6	6
J	6	6	6	6	8	8	8	8	8
Mass (kg)	0.7	0.7	0.7	0.8	0.8	0.8	0.9	0.9	0.9

② Compatible Controllers

RCP3 series actuators can be operated with the controllers indicated below. Select the type according to your intended application.

Title	External View	Model	Features	Maximum number of positioning points	Input power	Power-supply capacity	Standard price	Reference Page
Solenoid valve type		PMEC-C-28PI-NP-2-①	Easy-to-use controller, even for beginners	3 points	AC100V AC200V	See the ROBO Cylinder general catalog.	-	→ P131
		PSEP-C-28PI-NP-2-0	Operable with the same signal as a solenoid valve. Supports both single and double solenoid types. No homing necessary with the simple absolute type.					
Splash-proof solenoid type		PSEP-CW-28PI-NP-2-0						→ P141
Positioner type		PCON-C-28PI-NP-2-0	Up to 512 positioning points are supported.	512 points				
Safety-compliant positioner type		PCON-CG-28PI-NP-2-0						
Pulse-train input type (Differential line driver)		PCON-PL-28PI-NP-2-0	Pulse-train input type with differential line driver support	(-)	DC24V	Maximum: 2A		See the ROBO Cylinder general catalog
Pulse-train input type (Open collector)		PCON-PO-28PI-NP-2-0	Pulse-train input type with open collector support					
Serial communication type		PCON-SE-28PI-N-0-0	Dedicated to serial communication	64 points				
Field network type		RPCON-28P	Dedicated to a field network	768 points				
Program control type		PSEL-C-1-28PI-NP-2-0	Program operation is supported. Up to two axes can be operated.	1500 points				

* This is for the single-axis PSEL
* ① indicates the power-supply voltage type (1: 100V / 2: 100 to 240V).

- Mini Slider type
- Mini Rod type
- Mini Table type
- Mini Servo type
- Controller
- Compact
- Wide
- Flat
- Coupling
- Side-mounted

RCA2-TA4C

ROBO Cylinder Mini Table Type Motor Unit Coupling Type Actuator Width 40 mm 24V Servo Motor Ball Screw Specification

Model Description	RCA2 — TA4C	I — 10	<input type="checkbox"/>	<input type="checkbox"/>	<input type="checkbox"/>	<input type="checkbox"/>	<input type="checkbox"/>	
Series	Type	Encoder type	Motor type	Lead	Stroke	Compatible controllers	Cable length	Option
		I: Incremental specification * Model number is "I" when used with simple absolute unit.	10: Servo motor 10W	6: 6mm 4: 4mm 2: 2mm	20: 20mm ? 100: 100mm (set in steps every 10mm)	A1: ACON RACON ASEL A3: AMEC ASEP	N: None P: 1 m S: 3 m M: 5 m X <input type="checkbox"/> : Length Designation	K2: Connector cable exits from the front LA: Power-saving specification

* See page 14 for details on the model descriptions.

Power-saving specification

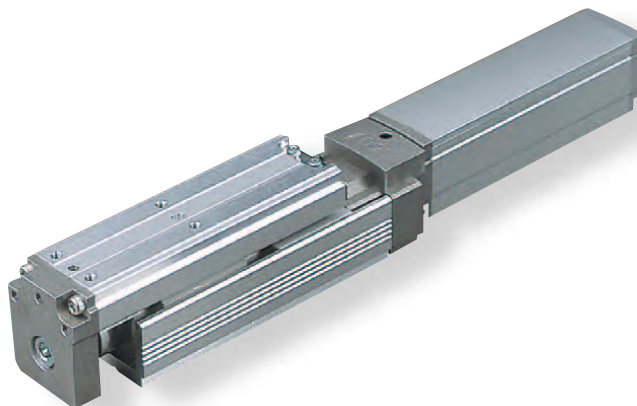

Photo above shows the TA3C.

POINT
Notes on selection
(1) The payload is the value when operated with acceleration of 0.3G (or 0.2G in the case of Lead 2 and vertical usage). The upper limit for acceleration is 0.3G (or 0.2G in the case of Lead 2 and vertical usage).

Actuator Specifications Table

Leads and Payloads

Model	Motor output (W)	Feed screw	Lead (mm)	Maximum payload		Rated thrust (N)	Positioning repeatability (mm)	Stroke (mm)
				Horizontal (kg)	Vertical (kg)			
RCA2-TA4C-I-10-6-①-②-③-④	10	Ball screw	6	1	0.5	28	±0.02	20 to 100 (every 10mm)
RCA2-TA4C-I-10-4-①-②-③-④			4	2	1	43		
RCA2-TA4C-I-10-2-①-②-③-④			2	3	1.5	85		

Legend ① Stroke ② Compatible Controllers ③ Cable length ④ Option

Stroke and Maximum Speed

Lead	Stroke	
	20 to 100 (mm)	20 to 100 (mm)
Ball screw	6	300
	4	200
	2	100

(unit: mm/s)

① Stroke list

Stroke (mm)	Standard price
20	—
30	—
40	—
50	—
60	—
70	—
80	—
90	—
100	—

④ Options

Title	Option code	See page	Standard price
Brake	B	—	—
Cable exit direction (top)	CJT	—	—
Cable exit direction (right)	CJR	—	—
Cable exit direction (left)	CJL	—	—
Cable exit direction (bottom)	CJB	—	—
Power-saving specification	LA	—	—
Reversed-home specification	NM	—	—

③ Cable Length

Type	Cable symbol	Standard price
Standard type (Robot cable)	P (1m)	—
	S (3m)	—
	M (5m)	—
Special length	X06 (6m) ~ X10 (10m)	—
	X11 (11m) ~ X15 (15m)	—
	X16 (16m) ~ X20 (20m)	—

* Robot type cable comes as standard with RCA2 actuator.

Actuator Specifications

Item	Description
Drive System	Ball screw, ø6mm, rolled C10
Lost motion	0.1mm or less
Base	Material: Aluminum, white alumite treated
Dynamic allowable moment (Note)	Ma: 4.2 N·m Mb: 6 N·m Mc: 8.2 N·m
Ambient operating temperature, humidity	0 to 40°C, 85% RH or less (Non-condensing)

(Note) For case of 5,000km service life.

Directions of allowable load moments



Dimensional Drawings

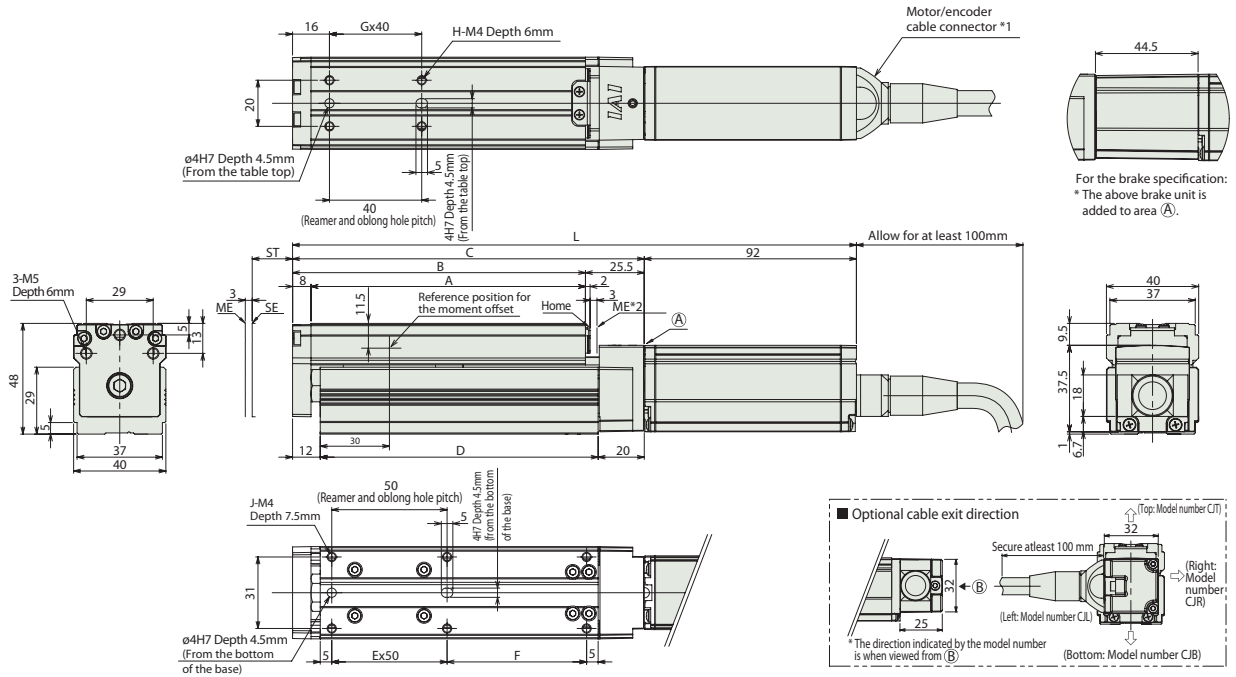

- * 1 The motor-encoder cable is connected directly to the actuator motor cover.
- * 2 The slider moves to the mechanical end during home return. Pay attention to prevent contact between the slider and surrounding parts.

ST : Stroke
ME : Mechanical end
SE : Stroke end

Dimensions and Weight by Stroke * The attached brake adds 0.2kg of mass.

Stroke	20	30	40	50	60	70	80	90	100
No brake	214.5	224.5	234.5	244.5	254.5	264.5	274.5	284.5	294.5
Brake-equipped	259	269	279	289	299	309	319	329	339
A	89	99	109	119	129	139	149	159	169
B	97	107	117	127	137	147	157	167	177
C	122.5	132.5	142.5	152.5	162.5	172.5	182.5	192.5	202.5
D	90.5	100.5	110.5	120.5	130.5	140.5	150.5	160.5	170.5
E	1	1	1	1	2	2	2	2	2
F	30.5	40.5	50.5	60.5	20.5	30.5	40.5	50.5	60.5
G	1	1	1	1	2	2	2	2	2
H	4	4	4	4	6	6	6	6	6
J	6	6	6	6	8	8	8	8	8
Mass (kg)	0.8	0.8	0.8	0.9	0.9	0.9	1.0	1.0	1.0

Compatible Controllers

RCA2 series actuators can be operated with the controllers indicated below. Select the type according to your intended application.

Title	External View	Model	Features	Maximum number of positioning points	Input power	Power-supply capacity	Standard price	Reference Page
Solenoid valve type		AMEC-C-10①-NP-2-1	Easy-to-use controller, even for beginners	3 points	AC100V	Rated: 2.4A	-	→ P131
Splash-proof solenoid type		ASEP-C-10①-NP-2-0	Operable with the same signal as a solenoid valve. Supports both single and double solenoid types. No homing necessary with the simple absolute type.					
Positioner type		ACON-C-10①-NP-2-0	Up to 512 positioning points are supported.	512 points	DC24V	(Standard specification) Rated: 1.3A Maximum: 4.4 A	-	→ P141
Safety-compliant positioner type		ACON-CG-10①-NP-2-0						
Pulse-train input type (Differential line driver)		ACON-PL-10①-NP-2-0	Pulse-train input type with differential line driver support	(-)	DC24V	(Power-saving specification) Rated: 1.3A Maximum: 2.5A	-	See the ROBO Cylinder general catalog
Pulse-train input type (Open collector)		ACON-PO-10①-NP-2-0	Pulse-train input type with open collector support					
Serial communication type		ACON-SE-10①-N-0-0	Dedicated to serial communication	64 points				
Field network type		RACON-10①	Dedicated to a field network	768 points				
Program control type		ASEL-C-1-10①-NP-2-0	Program operation is supported. Up to two axes can be operated.	1500 points				

* This is for the single-axis ASEL
* Enter the code "LA" in ① when the power-saving specification is specified.



RCP3-TA3R

ROBO Cylinder Mini Table Type Side-Mounted Motor Type Actuator Width 72 mm Pulse Motor Ball Screw Specification

Model Description	RCP3 — TA3R — I — 20P — <input type="checkbox"/> — <input type="checkbox"/> — <input type="checkbox"/> — <input type="checkbox"/> — <input type="checkbox"/>							
Series	Type	Encoder type	Motor type	Lead	Stroke	Compatible controllers	Cable length	Option
I: Incremental specification * Model number is "I" when used with simple absolute unit.	20P: Pulse motor 20□Size	6: 6mm 4: 4mm 2: 2mm	20: 20mm ? 100: 100mm (set in steps every 10mm)	P1: PCON PSEL P3: PMEC PSEP	N: None P: 1 m S: 3 m M: 5 m X□□: Length Designation	See option table below. * Be sure to specify which side the motor is to be mounted (ML/MR)		

* See page 14 for details on the model descriptions.



Photo above shows specification with motor side-mounted to the left (ML Option).

Correlation Diagrams of Speed and Load Capacity
With the RCP3 series, due to the characteristics of the pulse motor, load capacity decreases as the speed increases. Use the chart below to confirm that the desired speed and load capacity requirements are met.

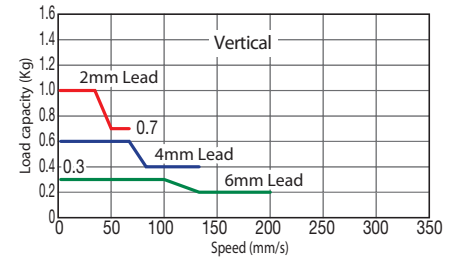
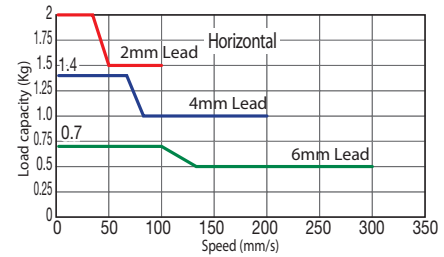

POINT Notes on selection
(1) The payload is the value when operated with acceleration of 0.3G (or 0.2G in the case of Lead 2 and vertical usage). The upper limit for acceleration is 0.3G (or 0.2G in the case of Lead 2 and vertical usage).

Actuator Specifications Table

Model	Feed screw	Lead (mm)	Maximum payload		Rated thrust (N)	Positioning repeatability (mm)	Stroke (mm)
			Horizontal (kg)	Vertical (kg)			
RCP3-TA3R-I-2P0-6-①-②-③-④	Ball screw	6	~0.7	~0.3	9	±0.02	20 to 100 (every 10mm)
RCP3-TA3R-I-20P-4-①-②-③-④		4	~1.4	~0.6	14		
RCP3-TA3R-I-20P-2-①-②-③-④		2	~2	~1	28		

Legend ① Stroke ② Compatible Controllers ③ Cable length ④ Option (Note 2) For a graph of the pushing force, see P127. * < > Indicates vertical use (unit: mm/s)

① Stroke list

Stroke (mm)	Standard price
20	—
30	—
40	—
50	—
60	—
70	—
80	—
90	—
100	—

④ Options

Title	Option code	See page	Standard price
Brake	B	—	—
Side-mounted motor to the left (standard)	ML	—	—
Side-mounted motor to the right	MR	—	—
Reversed-home specification	NM	—	—

③ Cable Length

Type	Cable symbol	Standard price
Standard type (Robot cable)	P (1m)	—
	S (3m)	—
	M (5m)	—
Special length	X06 (6m) ~ X10 (10m)	—
	X11 (11m) ~ X15 (15m)	—
	X16 (16m) ~ X20 (20m)	—

* Robot type cable comes as standard with RCP3 actuator.

Actuator Specifications

Item	Description
Drive System	Ball screw, ø6mm, rolled C10
Lost motion	0.1mm or less
Base	Material: Aluminum, white alumite treated
Dynamic allowable moment (Note 3)	Ma: 3.2 N·m Mb: 4.6 N·m Mc: 5.1 N·m
Ambient operating temperature, humidity	0 to 40°C, 85% RH or less (Non-condensing)

(Note 3) For case of 5,000km service life.

Directions of allowable load moments

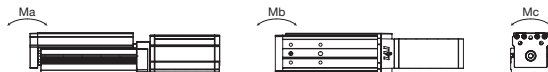

Dimensional Drawings

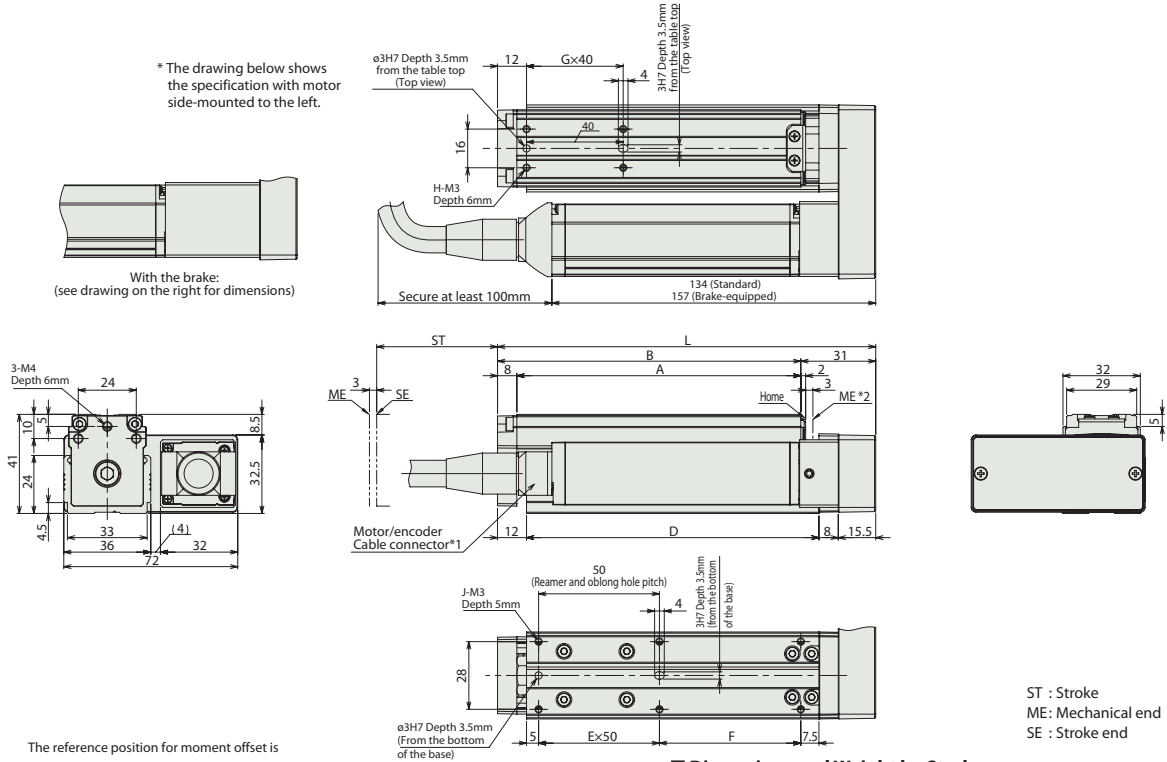

The reference position for moment offset is the same as the position on the TA3C (P. 90).

- * 1 The motor-encoder cable is connected directly to the actuator motor cover.
- * 2 The slider moves to the mechanical end during home return. Pay attention to prevent contact between the slider and surrounding parts.

■ Dimensions and Weight by Stroke * The attached brake adds 0.1kg of mass.

Stroke	20	30	40	50	60	70	80	90	100
L	126.5	136.5	146.5	156.5	166.5	176.5	186.5	196.5	206.5
A	87.5	97.5	107.5	117.5	127.5	137.5	147.5	157.5	167.5
B	95.5	105.5	115.5	125.5	135.5	145.5	155.5	165.5	175.5
D	91	101	111	121	131	141	151	161	171
E	1	1	1	1	2	2	2	2	2
F	28.5	38.5	48.5	58.5	18.5	28.5	38.5	48.5	58.5
G	1	1	1	1	2	2	2	2	2
H	4	4	4	4	6	6	6	6	6
J	6	6	6	6	8	8	8	8	8
Mass (kg)	0.5	0.6	0.6	0.6	0.6	0.7	0.7	0.7	0.7

② Compatible Controllers

RCP3 series actuators can be operated with the controllers indicated below. Select the type according to your intended application.

Title	External View	Model	Features	Maximum number of positioning points	Input power	Power-supply capacity	Standard price	Reference Page
Solenoid valve type		PMEC-C-20PI-NP-2-①	Easy-to-use controller, even for beginners	3 points	AC100V AC200V	See the ROBO Cylinder general catalog.	-	→ P131
	Splash-proof solenoid type		PSEP-C-20PI-NP-2-0					
Positioner type			PCON-C-20PI-NP-2-0	Up to 512 positioning points are supported.	512 points	-	-	
Safety-compliant positioner type		PCON-CG-20PI-NP-2-0	-					-
Pulse-train input type (Differential line driver)		PCON-PL-20PI-NP-2-0		Pulse-train input type with differential line driver support	(-)	DC24V	Maximum: 2A	
Pulse-train input type (Open collector)		PCON-PO-20PI-NP-2-0	Pulse-train input type with open collector support					
Serial communication type		PCON-SE-20PI-N-0-0	Dedicated to serial communication	64 points	-	-	-	
Field network type		RPCON-20P	Dedicated to a field network	768 points				
Program control type		PSEL-C-1-20PI-NP-2-0	Program operation is supported. Up to two axes can be operated.	1500 points	-	-	-	

* This is for the single-axis PSEL
* ① indicates the power-supply voltage type (1: 100V / 2: 100 to 240V).



RCP3-TA4R

ROBO Cylinder Mini Table Type Side-Mounted Motor Type Actuator Width 81 mm Pulse Motor Ball Screw Specification

Model Description	RCP3	TA4R	I	28P					
	Series	Type	Encoder type	Motor type	Lead	Stroke	Compatible controllers	Cable length	Option
			I: Incremental specification * Model number is "I" when used with simple absolute unit.	28P: Pulse motor 28□Size	6: 6mm 4: 4mm 2: 2mm	20: 20mm ? 100: 100mm (set in steps every 10mm)	P1: PCON RPCON PSEL P3: PMEC PSEP	N: None P: 1 m S: 3 m M: 5 m X□□: Length Designation	See option table below. * Be sure to specify which side the motor is to be mounted (ML/MR)

* See page 14 for details on the model descriptions.

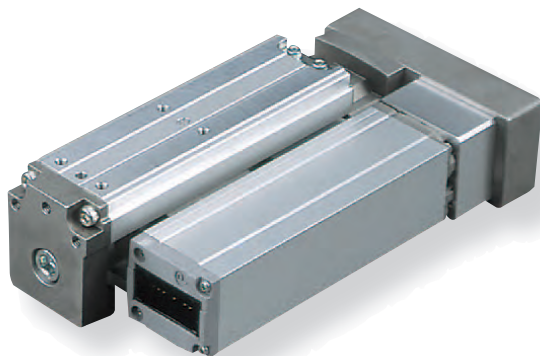
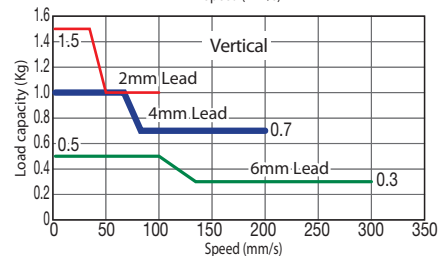
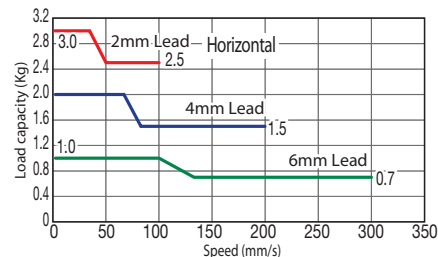

Photo above shows specification with TA3R motor side-mounted to the left (ML).

Correlation Diagrams of Speed and Load Capacity
With the RCP3 series, due to the characteristics of the pulse motor, load capacity decreases as the speed increases. Use the chart below to confirm that the desired speed and load capacity requirements are met.



POINT
Notes on selection
(1) The payload is the value when operated with acceleration of 0.3G (or 0.2G in the case of Lead 2 and vertical usage). The upper limit for acceleration is 0.3G (or 0.2G in the case of Lead 2 and vertical usage).

Actuator Specifications Table

Leads and Payloads

(Note 1) Please note that the maximum payload decreases as the speed increases.

Model	Feed screw	Lead (mm)	Maximum payload		Rated thrust (N)	Positioning repeatability (mm)	Stroke (mm)
			Horizontal (kg)	Vertical (kg)			
RCP3-TA4R-I-28P-6-①-②-③-④	Ball screw	6	~1	~0.5	15	±0.02	20 to 100 (every 10mm)
RCP3-TA4R-I-28P-4-①-②-③-④		4	~2	~1	22		
RCP3-TA4R-I-28P-2-①-②-③-④		2	~3	~1.5	44		

Legend ① Stroke ② Compatible Controllers ③ Cable length ④ Option

(Note 2) For a graph of the pushing force, see P127.

Stroke and Maximum Speed

Lead	Stroke	
	20 to 100 (mm)	20 to 100 (mm)
Ball screw	6	300
	4	200
	2	100

(unit: mm/s)

① Stroke list

Stroke (mm)	Standard price
20	—
30	—
40	—
50	—
60	—
70	—
80	—
90	—
100	—

④ Options

Title	Option code	See page	Standard price
Brake	B	—	—
Cable exit direction (top)	CJT	—	—
Cable exit direction (outside)	CJO	—	—
Cable exit direction (bottom)	CJB	—	—
Side-mounted motor to the left (standard)	ML	—	—
Side-mounted motor to the right	MR	—	—
Reversed-home specification	NM	—	—

③ Cable Length

Type	Cable symbol	Standard price
Standard type (Robot cable)	P (1m)	—
	S (3m)	—
	M (5m)	—
Special length	X06 (6m) ~ X10 (10m)	—
	X11 (11m) ~ X15 (15m)	—
	X16 (16m) ~ X20 (20m)	—
		—

* Robot type cable comes as standard with RCP3 actuator.

Actuator Specifications

Item	Description
Drive System	Ball screw, ø6mm, rolled C10
Lost motion	0.1mm or less
Base	Material: Aluminum, white alumite treated
Dynamic allowable moment (Note 3)	Ma: 4.2 N·m Mb: 6 N·m Mc: 8.2 N·m
Ambient operating temperature, humidity	0 to 40°C, 85% RH or less (Non-condensing)

(Note 3) For case of 5,000km service life.

Directions of allowable load moments

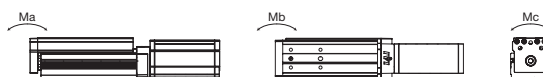

Dimensional Drawings

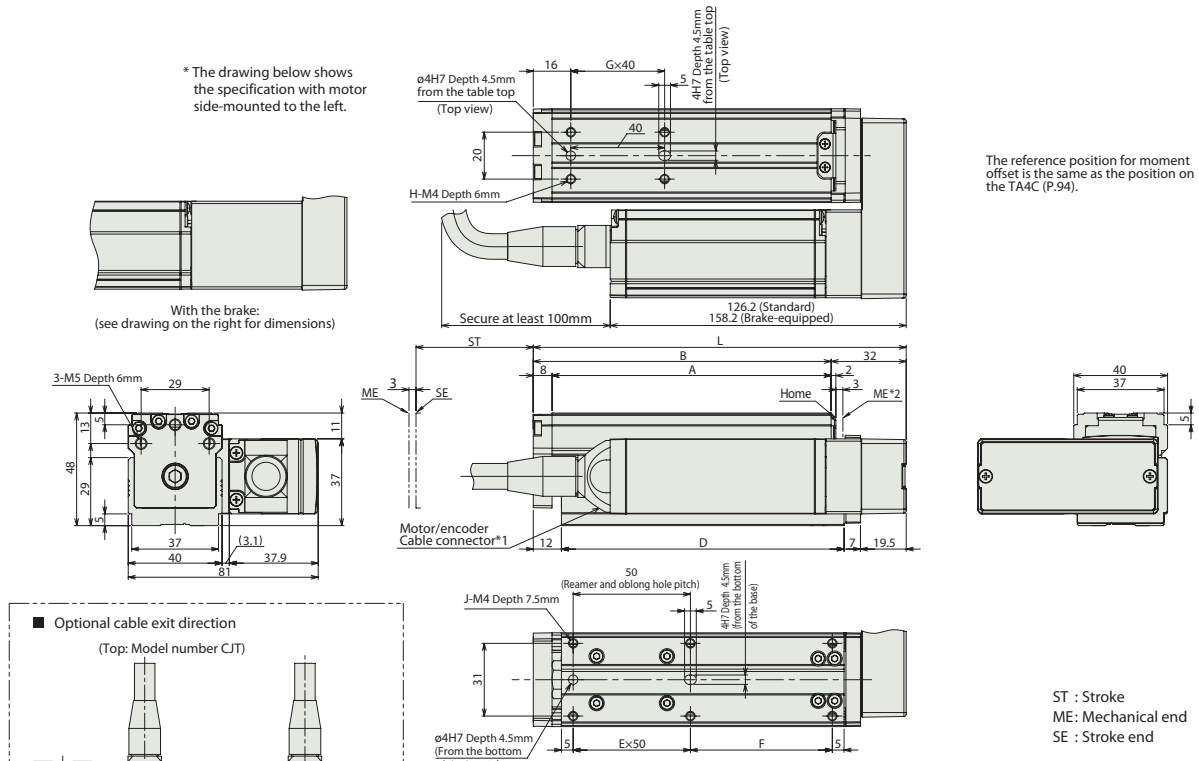

■ Dimensions and Weight by Stroke * The attached brake adds 0.2kg of mass.

Stroke	20	30	40	50	60	70	80	90	100
L	129	139	149	159	169	179	189	199	209
A	89	99	109	119	129	139	149	159	169
B	97	107	117	127	137	147	157	167	177
D	90.5	100.5	110.5	120.5	130.5	140.5	150.5	160.5	170.5
E	1	1	1	1	2	2	2	2	2
F	30.5	40.5	50.5	60.5	20.5	30.5	40.5	50.5	60.5
G	1	1	1	1	2	2	2	2	2
H	4	4	4	4	6	6	6	6	6
J	6	6	6	6	8	8	8	8	8
Mass (kg)	0.7	0.8	0.8	0.8	0.9	0.9	0.9	1.0	1.0

- * 1 The motor-encoder cable is connected directly to the actuator motor cover.
- * 2 The slider moves to the mechanical end during home return. Pay attention to prevent contact between the slider and surrounding parts.

② Compatible Controllers

RCP3 series actuators can be operated with the controllers indicated below. Select the type according to your intended application.

Title	External View	Model	Features	Maximum number of positioning points	Input power	Power-supply capacity	Standard price	Reference Page
Solenoid valve type		PMEC-C-28PI-NP-2-①	Easy-to-use controller, even for beginners	3 points	AC100V AC200V	See the ROBO Cylinder general catalog.	-	→ P131
	Splash-proof solenoid type		PSEP-C-28PI-NP-2-0					Operable with the same signal as a solenoid valve. Supports both single and double solenoid types. No homing necessary with the simple absolute type.
Positioner type			PCON-C-28PI-NP-2-0	Up to 512 positioning points are supported.	512 points	-	-	-
	Safety-compliant positioner type		PCON-CG-28PI-NP-2-0					
Pulse-train input type (Differential line driver)		PCON-PL-28PI-NP-2-0	Pulse-train input type with differential line driver support	(-)	DC24V	Maximum: 2A	-	See the ROBO Cylinder general catalog
Pulse-train input type (Open collector)		PCON-PO-28PI-NP-2-0	Pulse-train input type with open collector support					
Serial communication type		PCON-SE-28PI-N-0-0	Dedicated to serial communication	64 points	-	-	-	-
Field network type		RPCON-28P	Dedicated to a field network	768 points	-	-	-	-
Program control type		PSEL-C-1-28PI-NP-2-0	Program operation is supported. Up to two axes can be operated.	1500 points	-	-	-	-

* This is for the single-axis PSEL
* ① indicates the power-supply voltage type (1: 100V / 2: 100 to 240V).

RCA2-TA4R

ROBO Cylinder Mini Table Type Side-Mounted Motor Type Actuator Width 81 mm 24V Servo Motor Ball Screw Specification

Model Description	RCA2 — TA4R — I — 10 — [] — [] — [] — [] — []							
Series	Type	Encoder type	Motor type	Lead	Stroke	Compatible controllers	Cable length	Option
I: Incremental specification * Model number is "I" when used with simple absolute unit.	10: Servo motor 10W	6: 6mm 4: 4mm 2: 2mm	20: 20mm ? 100: 100mm (set in steps every 10mm)	A1: ACON RACON ASEL A3: AMEC ASEP	N: None P: 1 m S: 3 m M: 5 m X□□: Length Designation	See option table below. * Be sure to specify which side the motor is to be mounted (ML/MR)		

* See page 14 for details on the model descriptions.

Power-saving specification

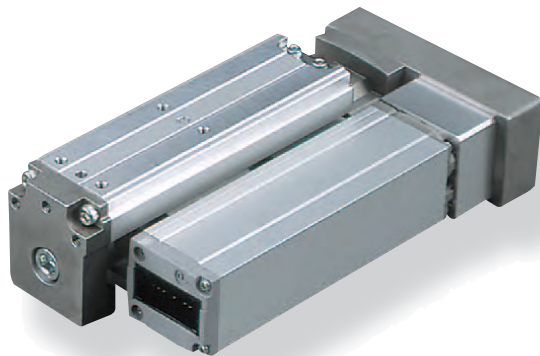

Photo above shows the specification with TA3R motor side-mounted to the left (ML).



(1) The payload is the value when operated with acceleration of 0.3G (or 0.2G in the case of Lead 2 and vertical usage). The upper limit for acceleration is 0.3G (or 0.2G in the case of Lead 2 and vertical usage).

Actuator Specifications Table

Leads and Payloads

Model	Motor output (W)	Feed screw	Lead (mm)	Maximum payload		Rated thrust (N)	Positioning repeatability (mm)	Stroke (mm)
				Horizontal (kg)	Vertical (kg)			
RCA2-TA4R-I-10-6-①-②-③-④	10	Ball screw	6	1	0.5	28	±0.02	20 to 100 (every 10mm)
RCA2-TA4R-I-10-4-①-②-③-④			4	2	1	43		
RCA2-TA4R-I-10-2-①-②-③-④			2	3	1.5	85		

Legend ① Stroke ② Compatible Controllers ③ Cable length ④ Option

Stroke and Maximum Speed

Lead	Stroke	20 to 100 (mm)
	Ball screw	6
4		200
2		100

(unit: mm/s)

① Stroke list

Stroke (mm)	Standard price
20	—
30	—
40	—
50	—
60	—
70	—
80	—
90	—
100	—

④ Options

Title	Option code	See page	Standard price
Brake	B	—	—
Cable exit direction (top)	CJT	—	—
Cable exit direction (outside)	CJO	—	—
Cable exit direction (bottom)	CJB	—	—
Power-saving specification	LA	—	—
Side-mounted motor to the left (standard)	ML	—	—
Side-mounted motor to the right	MR	—	—
Reversed-home specification	NM	—	—

③ Cable Length

Type	Cable symbol	Standard price
Standard type (Robot cable)	P (1m)	—
	S (3m)	—
	M (5m)	—
Special length	X06 (6m) ~ X10 (10m)	—
	X11 (11m) ~ X15 (15m)	—
	X16 (16m) ~ X20 (20m)	—

* Robot type cable comes as standard with RCA2 actuator.

Actuator Specifications

Item	Description
Drive System	Ball screw, ø6mm, rolled C10
Lost motion	0.1mm or less
Base	Material: Aluminum, white alumite treated
Dynamic allowable moment (Note)	Ma: 4.2 N·m Mb: 6 N·m Mc: 8.2 N·m
Ambient operating temperature, humidity	0 to 40°C, 85% RH or less (Non-condensing)

(Note) For case of 5,000km service life.

Dimensional Drawings

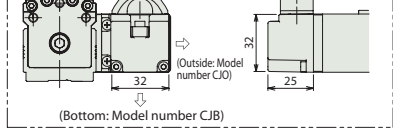
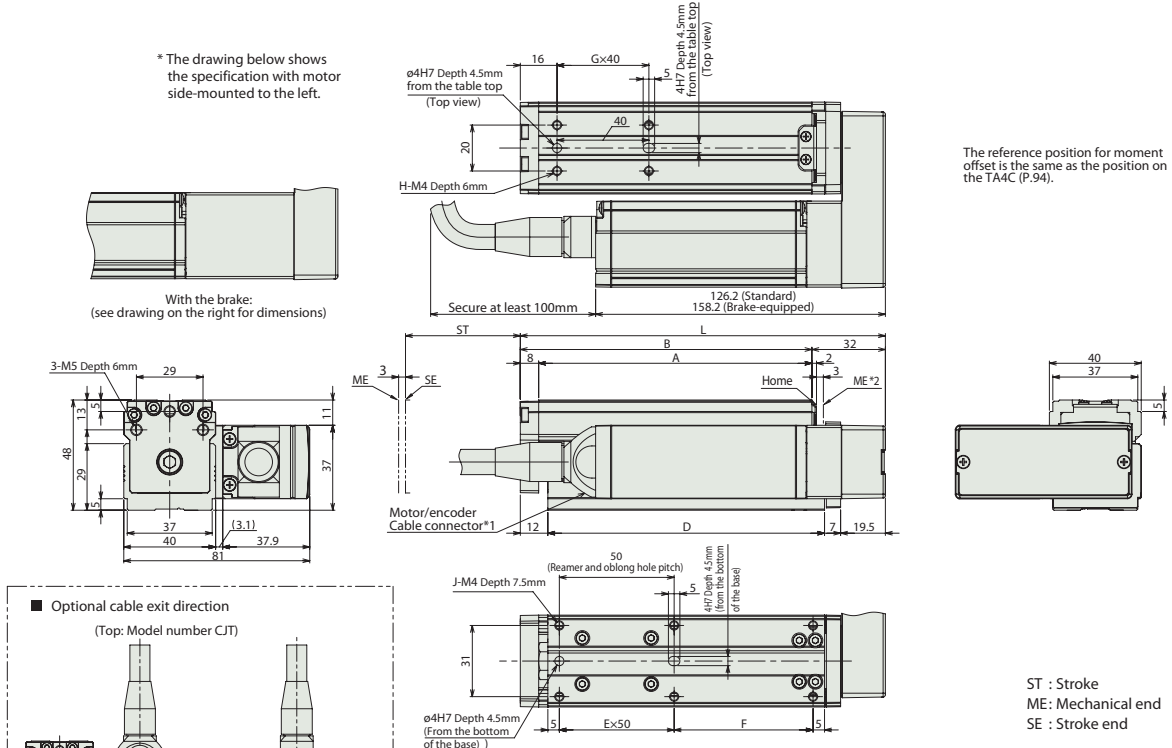

Dimensions and Weight by Stroke

The attached brake adds 0.2kg of mass.

Stroke	20	30	40	50	60	70	80	90	100
L	129	139	149	159	169	179	189	199	209
A	89	99	109	119	129	139	149	159	169
B	97	107	117	127	137	147	157	167	177
D	90.5	100.5	110.5	120.5	130.5	140.5	150.5	160.5	170.5
E	1	1	1	1	2	2	2	2	2
F	30.5	40.5	50.5	60.5	20.5	30.5	40.5	50.5	60.5
G	1	1	1	1	2	2	2	2	2
H	4	4	4	4	6	6	6	6	6
J	6	6	6	6	8	8	8	8	8
Mass (kg)	0.8	0.9	0.9	0.9	1.0	1.0	1.0	1.1	1.1

- * 1 The motor-encoder cable is connected directly to the actuator motor cover.
- * 2 The slider moves to the mechanical end during home return. Pay attention to prevent contact between the slider and surrounding parts.

Compatible Controllers

RCA2 series actuators can be operated with the controllers indicated below. Select the type according to your intended application.

Title	External View	Model	Features	Maximum number of positioning points	Input power	Power-supply capacity	Standard price	Reference Page
Solenoid valve type		AMEC-C-10①-NP-2-1	Easy-to-use controller, even for beginners	3 points	AC100V	Rated: 2.4A	-	→ P131
		ASEP-C-10①-NP-2-0	Operable with the same signal as a solenoid valve. Supports both single and double solenoid types. No homing necessary with the simple absolute type.					→ P141
Splash-proof solenoid type		ASEP-CW-10①-NP-2-0						
Positioner type		ACON-C-10①-NP-2-0	Up to 512 positioning points are supported.	512 points	DC24V	(Standard specification) Rated: 1.3A Maximum: 4.4 A	-	See the ROBO Cylinder general catalog
Safety-compliant positioner type		ACON-CG-10①-NP-2-0						
Pulse-train input type (Differential line driver)		ACON-PL-10①-NP-2-0	Pulse-train input type with differential line driver support	(-)		(Power-saving specification) Rated: 1.3A Maximum: 2.5A	-	
Pulse-train input type (Open collector)		ACON-PO-10①-NP-2-0	Pulse-train input type with open collector support					
Serial communication type		ACON-SE-10①-N-0-0	Dedicated to serial communication	64 points				
Field network type		RACON-10①	Dedicated to a field network	768 points				
Program control type		ASEL-C-1-10①-NP-2-0	Program operation is supported. Up to two axes can be operated.	1500 points				

* This is for the single-axis ASEL
* Enter the code "LA" in ① when the power-saving specification is specified.

Mini Slider type
Mini Rod type
Mini Table type
Mini Servo type
Controller
Compact
Wide
Flat
Coupling
Side-mounted

RCL-SA1L

ROBO Cylinder Mini Linear Servo Type Micro Slider Slim Type Actuator Width 20 mm Linear servo motor

■ Model Description	RCL — SA1L — I — 2 — N — 40 — <input type="checkbox"/> — <input type="checkbox"/>						
Series	Type	Encoder type	Motor type	Lead	Stroke	Compatible controllers	Cable length
		I: Incremental specification	2: Linear servo motor ZW	N: No screw	40: 40mm	A1:ACON RACON ASEL A3:AMEC ASEP	N: None P: 1 m S: 3 m M: 5 m X□□: Length Designation

* See page 14 for details on the model descriptions.

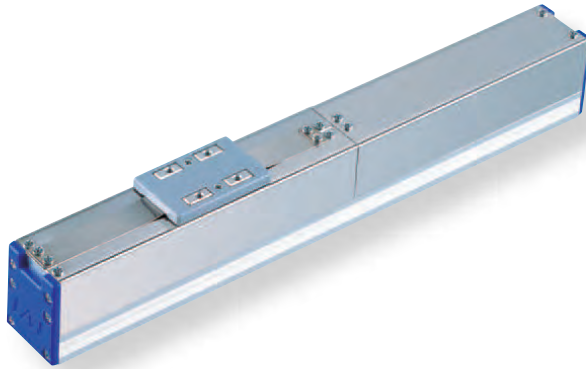

Relation between payload (horizontal) and acceleration

Maximum Acceleration (G)	Load Capacity (kg)	
	Continuous operation (Duty is 100%)	Duty is 70% or less
0.1	0.5	0.5
0.3		
0.5	0.42	
1	0.25	0.32
1.5	0.18	0.24
2	0.15	0.2

POINT
Notes on selection

(1) The payload is determined by the acceleration and duty.
Verify the payload in the payload (horizontal) and acceleration chart at right.
The duty is $\frac{\text{Operating time}}{\text{Operating time} + \text{stop time}} \times 100$ per cycle.

(2) The mounting position is horizontal-only. Please take care because the slider will drop down with power OFF when operating vertically.

(3) Simple absolute unit cannot be used with the RCL series.

Actuator Specifications Table

Leads and Payloads

Model	Motor output (W)	Maximum payload		Rated thrust (N)	Instantaneous maximum thrust (N)	Maximum acceleration (G)	Positioning repeatability (mm)	Stroke (mm)
		Horizontal (kg)	Vertical (kg)					
RCL-SA1L-I-2-N-40-①-②	2	See chart above	—	2	10	2	±0.1	40 (Fixed)

Legend ① Compatible Controllers ② Cable length

Stroke and Maximum Speed

Lead	Stroke	40 (mm)
	(no screw)	

(unit: mm/s)

Stroke list

Stroke (mm)	Standard price
40	—

③ Cable Length

Type	Cable symbol	Standard price
Standard type (Robot cable)	P (1m)	—
	S (3m)	—
	M (5m)	—
Special length	X06 (6m) ~ X10 (10m)	—
	X11 (11m) ~ X15 (15m)	—
	X16 (16m) ~ X20 (20m)	—

* The standard cable for the RCL is the robot cable.

Actuator Specifications

Item	Description
Drive System	Linear servo motor
Encoder resolution	0.042mm
Base	Material: Aluminum, white alumite treated
Dynamic allowable moment (Note)	Ma: 0.13 N-m Mb: 0.12 N-m Mc: 0.21 N-m
Overhung load length	50mm or less
Ambient operating temperature, humidity	0 to 40°C, 85% RH or less (Non-condensing)

(Note) For case of 5,000km service life.

Dimensional Drawings

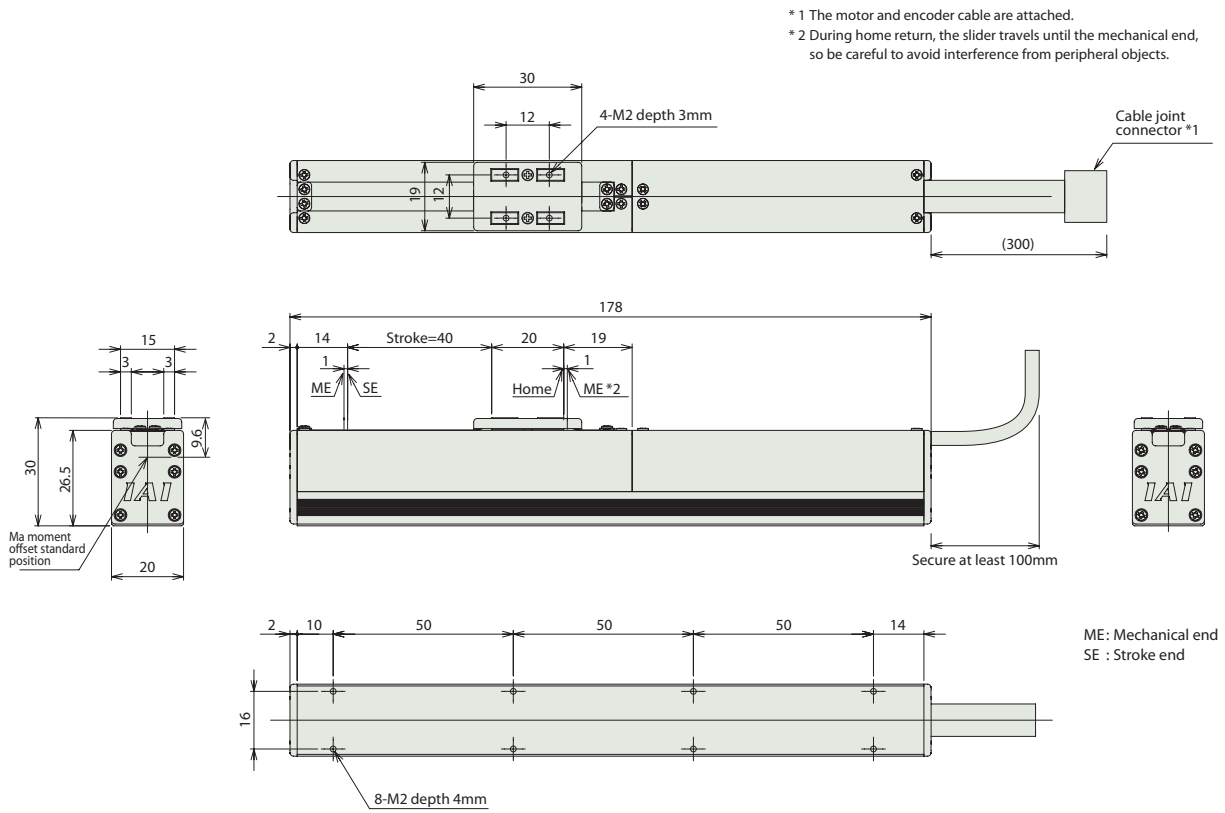

Dimensions and Weight by Stroke

Stroke	40
Mass (kg)	0.28

Compatible Controllers

RCL series actuators can be operated with the controllers indicated below. Select the type according to your intended application.

Title	External View	Model	Features	Maximum number of positioning points	Input power	Power-supply capacity	Standard price	Reference Page
Solenoid valve type		AMEC-C-2I-NP-2-1	Easy-to-use controller, even for beginners	3 points	AC100V	Rated: 2.4A	-	→ P131
Splash-proof solenoid type		ASEP-C-2I-NP-2-0	Operable with the same signal as a solenoid valve. Supports both single and double solenoid types. No homing necessary with the simple absolute type.					→ P141
Positioner type		ACON-C-2I-NP-2-0	Up to 512 positioning points are supported.	512 points	DC24V	Maximum: 4.6A	-	See the ROBO Cylinder general catalog
Safety-compliant positioner type		ACON-CG-2I-NP-2-0						
Pulse-train input type (Differential line driver)		ACON-PL-2I-NP-2-0	Pulse-train input type with differential line driver support	(-)	DC24V	Maximum: 4.6A	-	
Pulse-train input type (Open collector)		ACON-PO-2I-NP-2-0	Pulse-train input type with open collector support					
Serial communication type		ACON-SE-2I-N-0-0	Dedicated to serial communication	64 points	DC24V	Maximum: 4.6A	-	
Field network type		RACON-2	Dedicated to a field network	768 points				
Program control type		ASEL-C-1-2I-NP-2-0	Program operation is supported. Up to two axes can be operated.	1500 points	DC24V	Maximum: 4.6A	-	

* This is for the single-axis ASEL

RCL-SA2L

ROBO Cylinder Mini Linear Servo Type Micro Slider Slim Type Actuator Width 24 mm Linear servo motor

Model Description	RCL — SA2L — I — 5 — N — 48 — <input type="checkbox"/> — <input type="checkbox"/>
Series	Type
Encoder type	Motor type
Lead	Stroke
Compatible controllers	Cable length
A1:ACON RACON ASEL A3:AMEC ASEP	N: None P: 1 m S: 3 m M: 5 m X□□: Length Designation
I: Incremental specification	S: Linear servo motor 5W
N: No screw	48: 48mm

* See page 14 for details on the model descriptions.

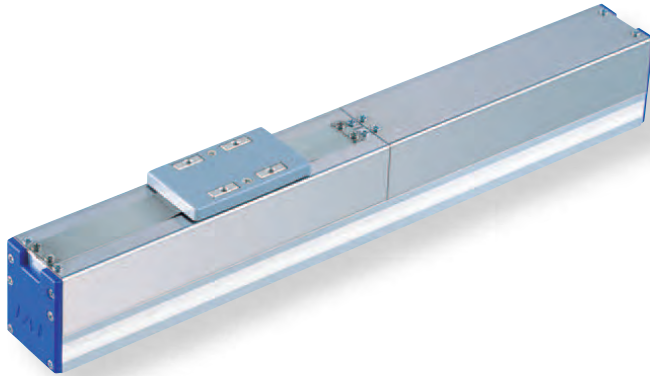

Relation between payload (horizontal) and acceleration

Maximum Acceleration (G)	Load Capacity (kg)	
	Continuous operation (Duty is 100%)	Duty is 70% or less
0.1	1	1
0.3		
0.5	0.85	
1	0.5	0.6
1.5	0.36	0.45
2	0.3	0.36

POINT
Notes on selection

(1) The payload is determined by the acceleration and duty.
Verify the payload in the payload (horizontal) and acceleration chart at right.
The duty is $\frac{\text{Operating time}}{\text{Operating time} + \text{stop time}} \times 100$ per cycle.

(2) The mounting position is horizontal-only. Please take care because the slider will drop down with power OFF when operating vertically.

(3) Simple absolute unit cannot be used with the RCL series.

Actuator Specifications Table

Leads and Payloads

Model	Motor output (W)	Maximum payload		Rated thrust (N)	Instantaneous maximum thrust (N)	Maximum acceleration (G)	Positioning repeatability (mm)	Stroke (mm)
		Horizontal (kg)	Vertical (kg)					
RCL-SA2L-I-5-N-48-①-②	5	See chart above	—	4	18	2	±0.1	48 (Fixed)

Legend ① Compatible Controllers ② Cable length

Stroke and Maximum Speed

Lead	Stroke	48 (mm)
	(no screw)	

(unit: mm/s)

Stroke list

Stroke (mm)	Standard price
48	—

③ Cable Length

Type	Cable symbol	Standard price
Standard type (Robot cable)	P (1m)	—
	S (3m)	—
	M (5m)	—
Special length	X06 (6m) ~ X10 (10m)	—
	X11 (11m) ~ X15 (15m)	—
	X16 (16m) ~ X20 (20m)	—
		—

* The standard cable for the RCL is the robot cable.

Actuator Specifications

Item	Description
Drive System	Linear servo motor
Encoder resolution	0.042mm
Base	Material: Aluminum, white alumite treated
Dynamic allowable moment (Note)	Ma: 0.2 N·m Mb: 0.17 N·m Mc: 0.25 N·m
Overhung load length	60mm or less
Ambient operating temperature, humidity	0 to 40°C, 85% RH or less (Non-condensing)

(Note) For case of 5,000km service life.

Dimensional Drawings

- * 1 The motor and encoder cable are attached.
- * 2 During home return, the slider travels until the mechanical end, so be careful to avoid interference from peripheral objects.

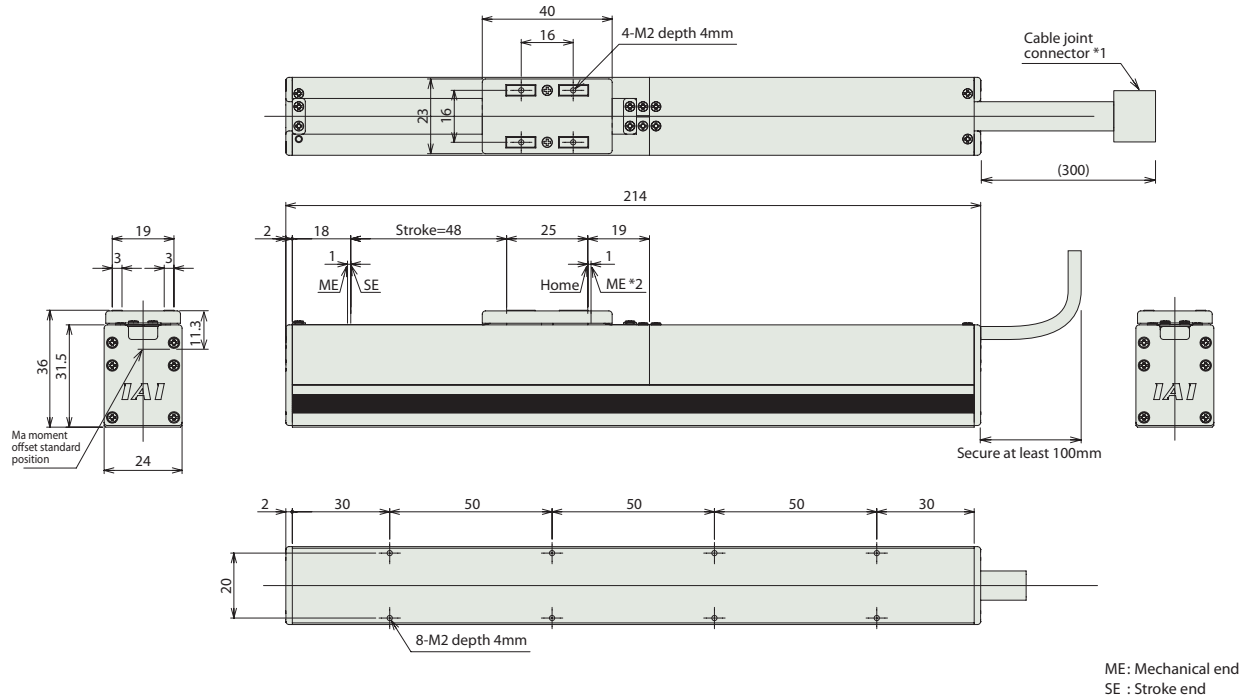

■ Dimensions and Weight by Stroke

Stroke	48
Mass (kg)	0.45

① Compatible Controllers

RCL series actuators can be operated with the controllers indicated below. Select the type according to your intended application.

Title	External View	Model	Features	Maximum number of positioning points	Input power	Power-supply capacity	Standard price	Reference Page
Solenoid valve type		AMEC-C-5I-NP-2-1	Easy-to-use controller, even for beginners	3 points	AC100V	Rated: 2.4A	-	→ P131
		ASEP-C-5I-NP-2-0	Operable with the same signal as a solenoid valve. Supports both single and double solenoid types. No homing necessary with the simple absolute type.					
Splash-proof solenoid type		ASEP-CW-5I-NP-2-0						→ P141
Positioner type		ACON-C-5I-NP-2-0	Up to 512 positioning points are supported.	512 points	DC24V	Maximum: 6.4A	-	See the ROBO Cylinder general catalog
Safety-compliant positioner type		ACON-CG-5I-NP-2-0						
Pulse-train input type (Differential line driver)		ACON-PL-5I-NP-2-0	Pulse-train input type with differential line driver support	(-)	DC24V	Maximum: 6.4A	-	See the ROBO Cylinder general catalog
Pulse-train input type (Open collector)		ACON-PO-5I-NP-2-0	Pulse-train input type with open collector support					
Serial communication type		ACON-SE-5I-N-0-0	Dedicated to serial communication	64 points				
Field network type		RACON-5	Dedicated to a field network	768 points				
Program control type		ASEL-C-1-5I-NP-2-0	Program operation is supported. Up to two axes can be operated.	1500 points				

* This is for the single-axis ASEL

RCL-SA3L

ROBO Cylinder Mini Linear Servo Type Micro Slider Slim Type Actuator Width 28 mm Linear servo motor

Model Description	RCL — SA3L — I — 10 — N — 64 — <input type="checkbox"/> — <input type="checkbox"/>
Series	Type
Encoder type	Motor type
Lead	Stroke
Compatible controllers	Cable length
I: Incremental specification	10: Linear servo motor 10W
N: No screw	64: 64mm
A1: ACON RACON ASEL A3: AMEC ASEP	N: None P: 1 m S: 3 m M: 5 m X□□: Length Designation

* See page 14 for details on the model descriptions.

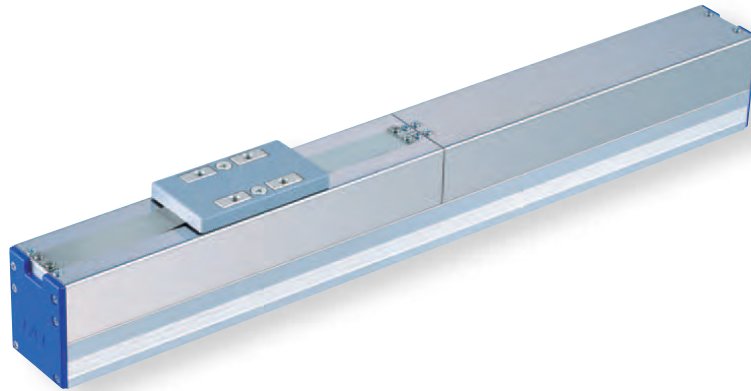

Relation between payload (horizontal) and acceleration

Maximum Acceleration (G)	Load Capacity (kg)	
	Continuous operation (Duty is 100%)	Duty is 70% or less
0.1	2	2
0.3		
0.5	1.8	
1	1	1.2
1.5	0.65	0.8
2	0.5	0.6

POINT
Notes on selection

(1) The payload is determined by the acceleration and duty. Verify the payload in the payload (horizontal) and acceleration chart at right.
The duty is $\frac{\text{Operating time}}{\text{Operating time} + \text{stop time}} \times 100$ per cycle.

(2) The mounting position is horizontal-only. Please take care because the slider will drop down with power OFF when operating vertically.

(3) Simple absolute unit cannot be used with the RCL series.

Actuator Specifications Table

Leads and Payloads

Model	Motor output (W)	Maximum payload		Rated thrust (N)	Instantaneous maximum thrust (N)	Maximum acceleration (G)	Positioning repeatability (mm)	Stroke (mm)
		Horizontal (kg)	Vertical (kg)					
RCL-SA3L-I-10-N-64-①-②	10	See chart above	—	8	30	2	±0.1	64(Fixed)

Legend ① Compatible Controllers ② Cable length

Stroke and Maximum Speed

Lead	Stroke	64 (mm)
	(no screw)	

(unit: mm/s)

Stroke list

Stroke (mm)	Standard price
64	—

③ Cable Length

Type	Cable symbol	Standard price
Standard type (Robot cable)	P (1m)	—
	S (3m)	—
	M (5m)	—
Special length	X06 (6m) ~ X10 (10m)	—
	X11 (11m) ~ X15 (15m)	—
	X16 (16m) ~ X20 (20m)	—

* The standard cable for the RCL is the robot cable.

Actuator Specifications

Item	Description
Drive System	Linear servo motor
Encoder resolution	0.042mm
Base	Material: Aluminum, white alumite treated
Dynamic allowable moment (Note)	Ma: 1.22 N·m Mb: 1.08 N·m Mc: 0.34 N·m
Overhung load length	Ma direction: 120mm or less, Mb and Mc directions: 80mm or less
Ambient operating temperature, humidity	0 to 40°C, 85% RH or less (Non-condensing)

(Note) For case of 5,000km service life.

Dimensional Drawings

- * 1 The motor and encoder cable are attached.
- * 2 During home return, the slider travels until the mechanical end, so be careful to avoid interference from peripheral objects.

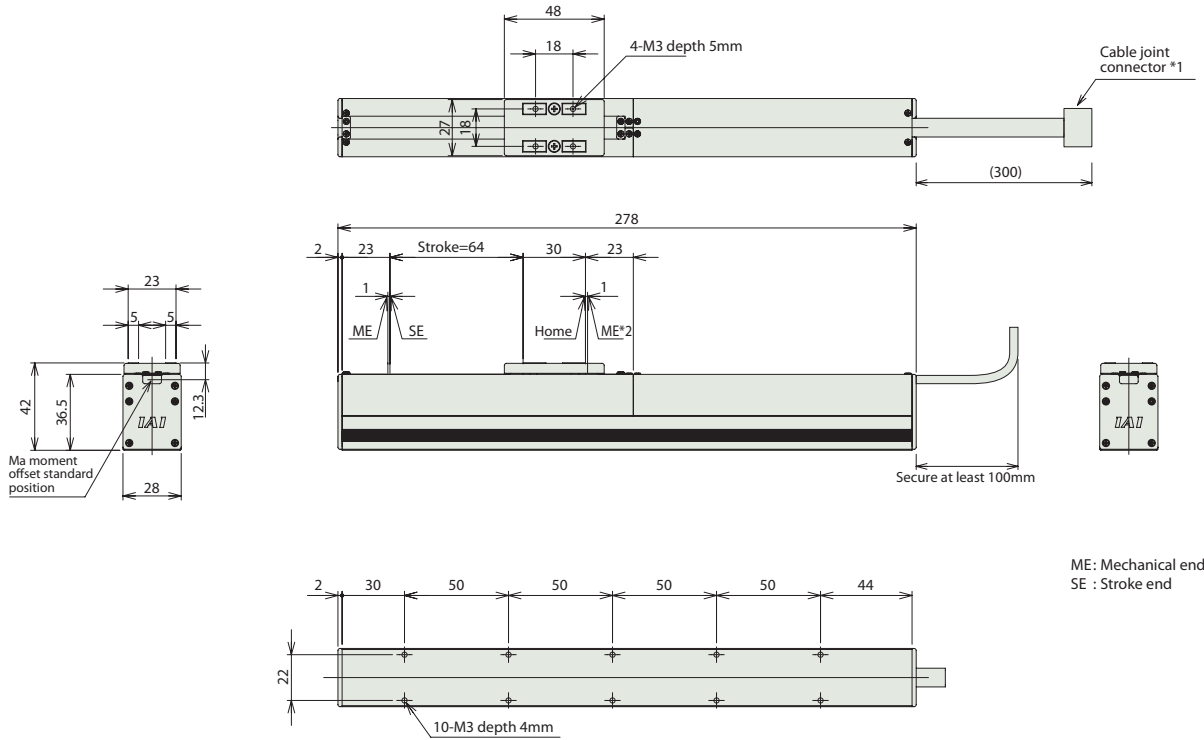

ME : Mechanical end
SE : Stroke end

■ Dimensions and Weight by Stroke

Stroke	64
Mass (kg)	0.82

① Compatible Controllers

RCL series actuators can be operated with the controllers indicated below. Select the type according to your intended application.

Title	External View	Model	Features	Maximum number of positioning points	Input power	Power-supply capacity	Standard price	Reference Page
Solenoid valve type		AMEC-C-10I-NP-2-1	Easy-to-use controller, even for beginners	3 points	AC100V	Rated: 2.4A	-	→ P131
Splash-proof solenoid type		ASEP-C-10I-NP-2-0	Operable with the same signal as a solenoid valve. Supports both single and double solenoid types. No homing necessary with the simple absolute type.					→ P141
Positioner type		ACON-C-10I-NP-2-0	Up to 512 positioning points are supported.	512 points	DC24V	Maximum: 6.4A	-	See the ROBO Cylinder general catalog
Safety-compliant positioner type		ACON-CG-10I-NP-2-0						
Pulse-train input type (Differential line driver)		ACON-PL-10I-NP-2-0	Pulse-train input type with differential line driver support	(-)	-	-		
Pulse-train input type (Open collector)		ACON-PO-10I-NP-2-0	Pulse-train input type with open collector support					
Serial communication type		ACON-SE-10I-N-0-0	Dedicated to serial communication	64 points	-			
Field network type		RACON-10	Dedicated to a field network	768 points	-			
Program control type		ASEL-C-1-10I-NP-2-0	Program operation is supported. Up to two axes can be operated.	1500 points	-			

* This is for the single-axis ASEL



RCL-SA4L

ROBO Cylinder Mini Linear Servo Type Micro Slider Long Stroke Type Actuator Width 20 mm
Linear servo motor

Model Description	RCL — SA4L — I — 2 — N — <input type="checkbox"/> — <input type="checkbox"/> — <input type="checkbox"/> — <input type="checkbox"/>							
Series	Type	Encoder type	Motor type	Lead	Stroke	Compatible controllers	Cable length	Option
		I: Incremental specification	2: Linear servo motor ZW	N: No screw	30: 30mm ? : 180: 180mm (set in steps every 30mm)	A1:ACON RACON ASEL A3:AMEC ASEP	N: None P: 1 m S: 3 m M: 5 m X□□: Length Designation	NM: Reversed-home specification

* See page 15 for details on the model descriptions.



Relation between payload (horizontal) and acceleration

Maximum Acceleration (G)	Load Capacity (kg)	
	Continuous operation (Duty is 100%)	
0.1	0.8	
0.3		
0.5	0.5	
1	0.25	
1.5	0.18	
2	0.14	

POINT
Notes on selection

- Please take care because this type has magnetic flux leakage. (If magnetism is a problem, use SA1L/SA2L/SA3L)
- The payload is determined by the acceleration and duty. Verify the payload in the payload (horizontal) and acceleration chart at right.
The duty is $\frac{\text{Operating time}}{\text{Operating time} + \text{stop time}} \times 100$ per cycle.
- The mounting position is horizontal-only. Please take care because the slider will drop down with power OFF when operating vertically.
- Simple absolute unit cannot be used with the RCL series.

Actuator Specifications Table

Leads and Payloads

Model	Motor output (W)	Maximum payload		Rated thrust (N)	Instantaneous maximum thrust (N)	Maximum acceleration (G)	Positioning repeatability (mm)	Stroke (mm)
		Horizontal (kg)	Vertical (kg)					
RCL-SA4L-I-2-N-①-②-③-④	2	See chart above	—	2.5	10	2	±0.1	30 to 180 (set in 30mm increments)

Legend ① Stroke ② Compatible Controllers ③ Cable length ④ Option

Stroke and Maximum Speed

Lead	Stroke	30 to 180 (set in 30mm increments)
	(no screw)	1200

(unit: mm/s)

① Stroke list

Stroke (mm)	Standard price
30	—
60	—
90	—
120	—
150	—
180	—

③ Cable Length

Type	Cable symbol	Standard price
Standard type (Robot cable)	P (1m)	—
	S (3m)	—
	M (5m)	—
Special length	X06 (6m) ~ X10 (10m)	—
	X11 (11m) ~ X15 (15m)	—
	X16 (16m) ~ X20 (20m)	—
		—

* The standard cable for the RCL is the robot cable.

④ Options

Title	Option code	See page	Standard price
Reversed-home specification	NM	—	—

Actuator Specifications

Item	Description
Drive System	Linear servo motor
Encoder resolution	0.042mm
Base	Material: Aluminum, white alumite treated
Dynamic allowable moment (Note)	Ma: 0.2 N·m Mb: 0.17 N·m Mc: 0.25 N·m
Overhung load length	Ma direction: 60mm or less, Mb and Mc directions: 80mm or less
Ambient operating temperature, humidity	0 to 40°C, 85% RH or less (Non-condensing)

(Note) For case of 5,000km service life.

Dimensional Drawings

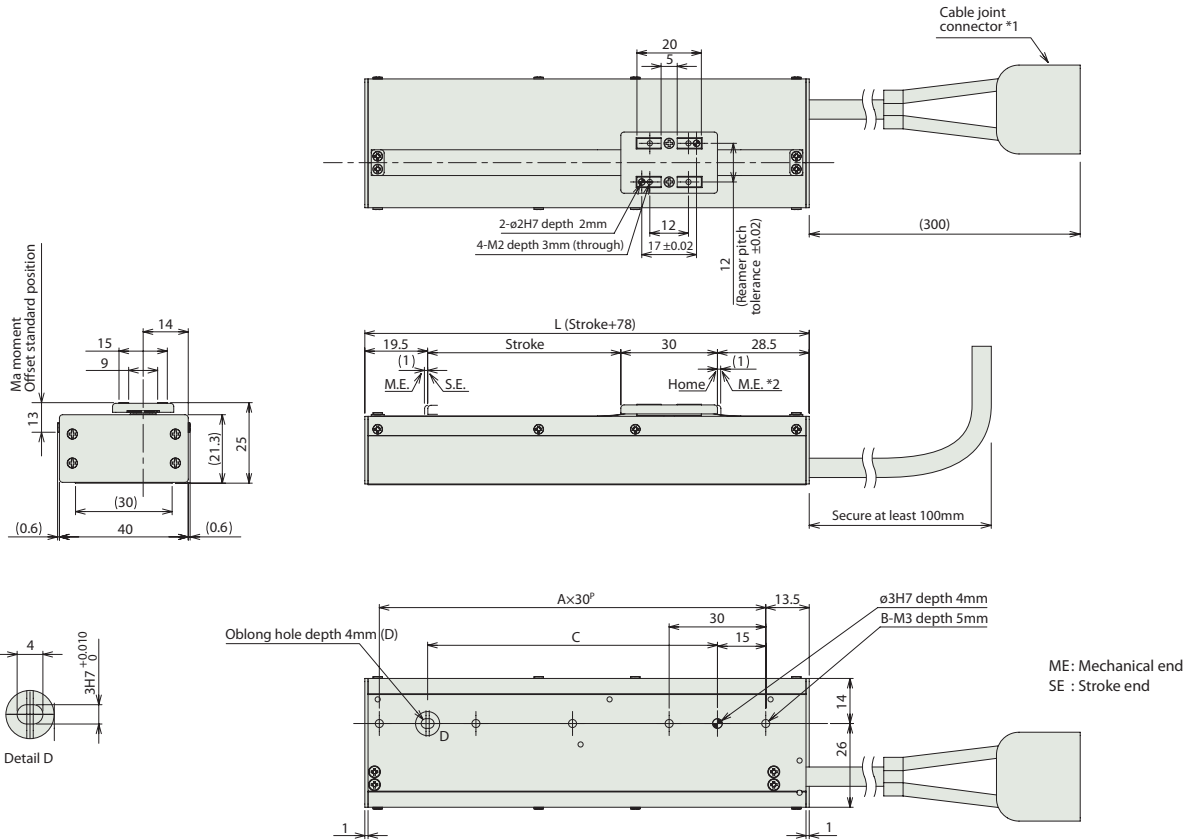

- * 1 The motor and encoder cable are attached.
- * 2 During home return, the slider travels until the mechanical end, so be careful to avoid interference from peripheral objects.

■ Dimensions and Weight by Stroke

Stroke	30	60	90	120	150	180
L	108	138	168	198	228	258
A	3	4	5	6	7	8
B	4	5	6	7	8	9
C	60	90	120	150	180	210
Mass (kg)	0.21	0.25	0.29	0.32	0.36	0.4

② Compatible Controllers

RCL series actuators can be operated with the controllers indicated below. Select the type according to your intended application.

Title	External View	Model	Features	Maximum number of positioning points	Input power	Power-supply capacity	Standard price	Reference Page
Solenoid valve type		AMEC-C-2I-NP-2-1	Easy-to-use controller, even for beginners	3 points	AC100V	Rated: 2.4A	-	→ P131
		ASEP-C-2I-NP-2-0	Operable with the same signal as a solenoid valve. Supports both single and double solenoid types. No homing necessary with the simple absolute type.					
Splash-proof solenoid type		ASEP-CW-2I-NP-2-0						→ P141
Positioner type		ACON-C-2I-NP-2-0	Up to 512 positioning points are supported.	512 points	DC24V	Maximum: 4.6A	-	See the ROBO Cylinder general catalog
Safety-compliant positioner type		ACON-CG-2I-NP-2-0						
Pulse-train input type (Differential line driver)		ACON-PL-2I-NP-2-0	Pulse-train input type with differential line driver support	(-)	DC24V	Maximum: 4.6A	-	See the ROBO Cylinder general catalog
Pulse-train input type (Open collector)		ACON-PO-2I-NP-2-0	Pulse-train input type with open collector support					
Serial communication type		ACON-SE-2I-N-0-0	Dedicated to serial communication	64 points				
Field network type		RACON-2	Dedicated to a field network	768 points				
Program control type		ASEL-C-1-2I-NP-2-0	Program operation is supported. Up to two axes can be operated.	1500 points				

* This is for the single-axis ASEL

RCL-SM4L

ROBO Cylinder Mini Linear Servo Type Multi Slider Long Stroke Type Actuator Width 40 mm
Linear servo motor

Model Description	RCL — SM4L — I — 2 — N — <input type="checkbox"/> — <input type="checkbox"/> — <input type="checkbox"/>				
Series	Type				
Encoder type	Motor type	Lead	Stroke	Compatible controllers	Cable length
I: Incremental specification	2: Linear servo motor ZW	N: No screw	30: 30mm ? : 120: 120mm (set in steps every 30mm)	A1:ACON RACON ASEL A3:AMEC ASEP	N: None P: 1 m S: 3 m M: 5 m X□□: Length Designation

* See page 14 for details on the model descriptions.

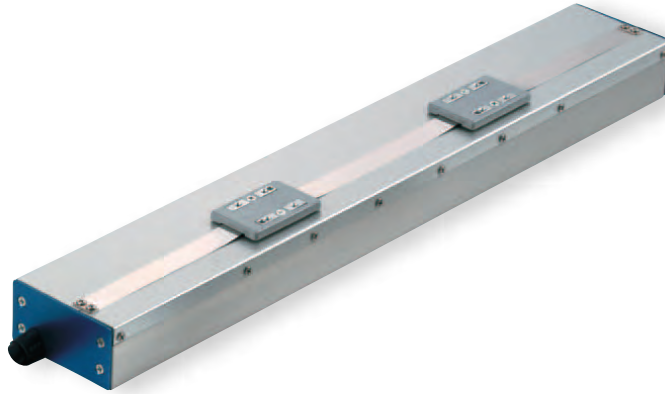

Relation between payload (horizontal) and acceleration

Maximum Acceleration (G)	Load Capacity (kg)	
	Continuous operation (Duty is 100%)	
0.1	0.8	
0.3		
0.5	0.5	
1	0.25	
1.5	0.18	
2	0.14	



- (1) Please take care because this type has magnetic flux leakage.
(If magnetism is a problem, use SA1L/SA2L/SA3L)
- (2) The payload is determined by the acceleration and duty.
Verify the payload in the payload (horizontal) and acceleration chart at right.
The duty is $\frac{\text{Operating time}}{\text{Operating time} + \text{stop time}} \times 100$ per cycle.
- (3) The mounting position is horizontal-only. Please take care because the slider will drop down with power OFF when operating vertically.
- (4) Simple absolute unit cannot be used with the RCL series.

Actuator Specifications Table

Leads and Payloads

Model	Motor output (W)	Maximum payload		Rated thrust (N)	Instantaneous maximum thrust (N)	Maximum acceleration (G)	Positioning repeatability (mm)	Stroke (mm)
		Horizontal (kg)	Vertical (kg)					
RCL-SM4L-I-2-N-①-②-③	2	See chart above	—	2.5	10	2	±0.1	30 to 120 (set in 30mm increments)

Legend ① Stroke ② Compatible Controllers ③ Cable length

Stroke and Maximum Speed

Lead	Stroke	30 to 120 (set in 30mm increments)
	(no screw)	1200

(unit: mm/s)

① Stroke list

Stroke (mm)	Standard price
30	—
60	—
90	—
120	—

③ Cable Length

Type	Cable symbol	Standard price
Standard type (Robot cable)	P (1m)	—
	S (3m)	—
	M (5m)	—
Special length	X06 (6m) ~ X10 (10m)	—
	X11 (11m) ~ X15 (15m)	—
	X16 (16m) ~ X20 (20m)	—

* The standard cable for the RCL is the robot cable.

Actuator Specifications

Item	Description
Drive System	Linear servo motor
Encoder resolution	0.042mm
Base	Material: Aluminum, white alumite treated
Dynamic allowable moment (Note)	Ma: 0.2 N·m Mb: 0.17 N·m Mc: 0.25 N·m
Overhung load length	Ma direction: 60mm or less, Mb and Mc directions: 80mm or less
Ambient operating temperature, humidity	0 to 40°C, 85% RH or less (Non-condensing)

(Note) For case of 5,000km service life.

Dimensional Drawings

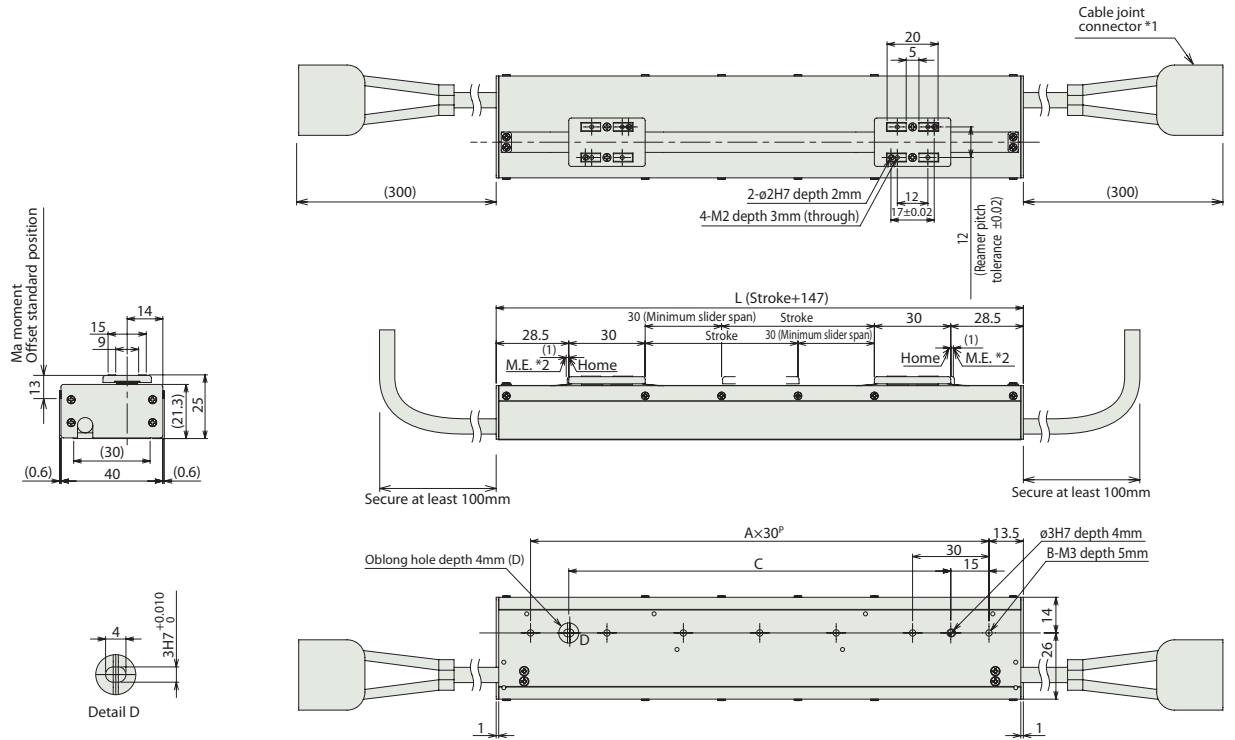

ME: Mechanical end
SE: Stroke end

- * 1 The motor and encoder cable are attached.
- * 2 During home return, the slider travels until the mechanical end, so be careful to avoid interference from peripheral objects.

Note
One controller is required for each slider.
(Or, one 2-axis controller is required.)

■ Dimensions and Weight by Stroke

Stroke	30	60	90	120
L	177	207	237	267
A	5	6	7	8
B	6	7	8	9
C	120	150	180	210
Mass (kg)	0.37	0.4	0.44	0.48

② Compatible Controllers

RCL series actuators can be operated with the controllers indicated below. Select the type according to your intended application.

Title	External View	Model	Features	Maximum number of positioning points	Input power	Power-supply capacity	Standard price	Reference Page
Solenoid valve type		AMEC-C-2I-NP-2-1	Easy-to-use controller, even for beginners	3 points	AC100V	Rated: 2.4A	-	→ P131
Splash-proof solenoid type		ASEP-C-2I-NP-2-0	Operable with the same signal as a solenoid valve. Supports both single and double solenoid types. No homing necessary with the simple absolute type.					
Positioner type		ACON-C-2I-NP-2-0	Up to 512 positioning points are supported.	512 points	DC24V	Maximum: 4.6A	-	See the ROBO Cylinder general catalog
Safety-compliant positioner type		ACON-CG-2I-NP-2-0						
Pulse-train input type (Differential line driver)		ACON-PL-2I-NP-2-0	Pulse-train input type with differential line driver support	(-)	DC24V	Maximum: 4.6A	-	See the ROBO Cylinder general catalog
Pulse-train input type (Open collector)		ACON-PO-2I-NP-2-0	Pulse-train input type with open collector support					
Serial communication type		ACON-SE-2I-N-0-0	Dedicated to serial communication	64 points	DC24V	Maximum: 4.6A	-	See the ROBO Cylinder general catalog
Field network type		RACON-2	Dedicated to a field network	768 points				
Program control type		ASEL-C-2-2I-2I-NP-2-0	Program operation is supported. Up to two axes can be operated.	1500 points	DC24V	Maximum: 9.2A	-	See the ROBO Cylinder general catalog



RCL-SA5L

ROBO Cylinder Mini Linear Servo Type Micro Slider Long Stroke Type Actuator Width 48 mm
Linear servo motor

Model Description	RCL — SA5L — I — 5 — N — <input type="checkbox"/> — <input type="checkbox"/> — <input type="checkbox"/> — <input type="checkbox"/>							
Series	Type	Encoder type	Motor type	Lead	Stroke	Compatible controllers	Cable length	Option
		I: Incremental specification	S: Linear servo motor SW	N: No screw	36: 36mm 216: 216mm (set in steps every 36mm)	A1:ACON RACON ASEL A3:AMEC ASEP	N: None P: 1 m S: 3 m M: 5 m X□□: Length Designation	NM: Reversed-home specification

* See page 14 for details on the model descriptions.



Relation between payload (horizontal) and acceleration

Maximum Acceleration (G)	Load Capacity (kg)	
	Continuous operation (Duty is 100%)	
0.1	1.6	
0.3		
0.5	1.0	
1	0.5	
1.5	0.35	
2	0.25	



- (1) Please take care because this type has magnetic flux leakage. (If magnetism is a problem, use SA1L/SA2L/SA3L)
- (2) The payload is determined by the acceleration and duty. Verify the payload in the payload (horizontal) and acceleration chart at right.
The duty is $\frac{\text{Operating time}}{\text{Operating time} + \text{stop time}} \times 100$ per cycle.
- (3) The mounting position is horizontal-only. Please take care because the slider will drop down with power OFF when operating vertically.
- (4) Simple absolute unit cannot be used with the RCL series.

Actuator Specifications Table

Leads and Payloads

Model	Motor output (W)	Maximum payload		Rated thrust (N)	Instantaneous maximum thrust (N)	Maximum acceleration (G)	Positioning repeatability (mm)	Stroke (mm)
		Horizontal (kg)	Vertical (kg)					
RCL-SA5L-I-5-N-①-②-③-④	5	See chart above	—	5	18	2	±0.1	36 to 216 (set in 36mm increments)

Legend ① Stroke ② Compatible Controllers ③ Cable length ④ Option

Stroke and Maximum Speed

Lead	Stroke	36 to 216 (set in 36mm increments)
	(no screw)	1400

(unit: mm/s)

① Stroke list

Stroke (mm)	Standard price
36	—
72	—
108	—
144	—
180	—
216	—

③ Cable Length

Type	Cable symbol	Standard price
Standard type (Robot cable)	P (1m)	—
	S (3m)	—
	M (5m)	—
Special length	X06 (6m) ~ X10 (10m)	—
	X11 (11m) ~ X15 (15m)	—
	X16 (16m) ~ X20 (20m)	—

* The standard cable for the RCL is the robot cable.

④ Options

Title	Option code	See page	Standard price
Reversed-home specification	NM	—	—

Actuator Specifications

Item	Description
Drive System	Linear servo motor
Encoder resolution	0.042mm
Base	Material: Aluminum, white alumite treated
Dynamic allowable moment (Note)	Ma:0.49 N·m Mb:0.41 N·m Mc:0.72 N·m
Overhung load length	Ma direction: 80mm or less, Mb and Mc directions: 100mm or less
Ambient operating temperature, humidity	0 to 40°C, 85% RH or less (Non-condensing)

(Note) For case of 5,000km service life.

Dimensional Drawings

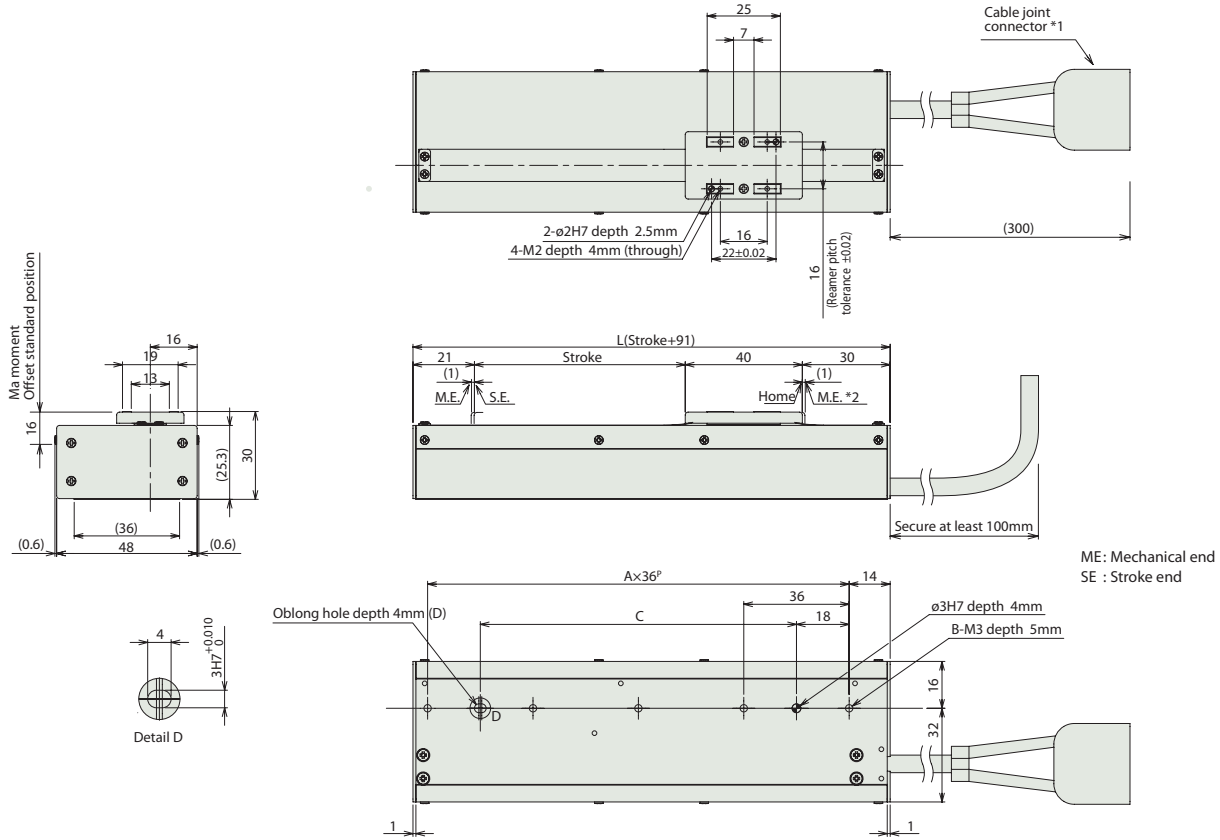

ME: Mechanical end
SE: Stroke end

* 1 The motor and encoder cable are attached.
* 2 During home return, the slider travels until the mechanical end, so be careful to avoid interference from peripheral objects.

■ Dimensions and Weight by Stroke

Stroke	36	72	108	144	180	216
L	127	163	199	235	271	307
A	3	4	5	6	7	8
B	4	5	6	7	8	9
C	72	108	144	180	216	252
Mass (kg)	0.35	0.42	0.48	0.55	0.62	0.68

② Compatible Controllers

RCL series actuators can be operated with the controllers indicated below. Select the type according to your intended application.

Title	External View	Model	Features	Maximum number of positioning points	Input power	Power-supply capacity	Standard price	Reference Page
Solenoid valve type		AMEC-C-5I-NP-2-1	Easy-to-use controller, even for beginners	3 points	AC100V	Rated: 2.4A	-	→ P131
		ASEP-C-5I-NP-2-0	Operable with the same signal as a solenoid valve. Supports both single and double solenoid types. No homing necessary with the simple absolute type.					
Splash-proof solenoid type		ASEP-CW-5I-NP-2-0						→ P141
Positioner type		ACON-C-5I-NP-2-0	Up to 512 positioning points are supported.	512 points	DC24V	Maximum: 6.4A	-	See the ROBO Cylinder general catalog
Safety-compliant positioner type		ACON-CG-5I-NP-2-0						
Pulse-train input type (Differential line driver)		ACON-PL-5I-NP-2-0	Pulse-train input type with differential line driver support	(-)	DC24V	Maximum: 6.4A	-	See the ROBO Cylinder general catalog
Pulse-train input type (Open collector)		ACON-PO-5I-NP-2-0	Pulse-train input type with open collector support					
Serial communication type		ACON-SE-5I-N-0-0	Dedicated to serial communication	64 points				
Field network type		RACON-5	Dedicated to a field network	768 points				
Program control type		ASEL-C-1-5I-NP-2-0	Program operation is supported. Up to two axes can be operated.	1500 points				

* This is for the single-axis ASEL



RCL-SM5L

ROBO Cylinder Mini Linear Servo Type Multi Slider Long Stroke Type Actuator Width 48 mm
Linear servo motor

Model Description	RCL — SM5L — I — 5 — N — <input type="checkbox"/> — <input type="checkbox"/> — <input type="checkbox"/>				
Series	Type				
Encoder type	Motor type	Lead	Stroke	Compatible controllers	Cable length
I: Incremental specification	S: Linear servo motor SW	N: No screw	36: 36mm } 144: 144mm (set in steps every 36mm)	A1:ACON RACON ASEL A3:AMEC ASEP	N: None P: 1 m S: 3 m M: 5 m X□□: Length Designation

* See page 14 for details on the model descriptions.

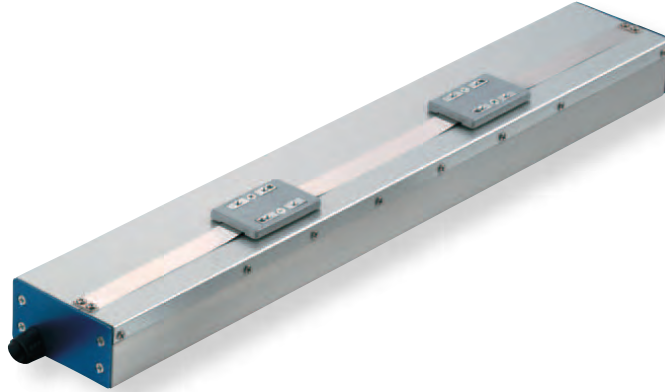

Relation between payload (horizontal) and acceleration

Maximum Acceleration (G)	Load Capacity (kg)	
	Continuous operation (Duty is 100%)	
0.1	1.6	
0.3		
0.5	1.0	
1	0.5	
1.5	0.35	
2	0.25	



- Please take care because this type has magnetic flux leakage. (If magnetism is a problem, use SA1L/SA2L/SA3L)
- The payload is determined by the acceleration and duty. Verify the payload in the payload (horizontal) and acceleration chart at right.
The duty is $\frac{\text{Operating time}}{\text{Operating time} + \text{stop time}} \times 100$ per cycle.
- The mounting position is horizontal-only. Please take care because the slider will drop down with power OFF when operating vertically.
- Simple absolute unit cannot be used with the RCL series.

Actuator Specifications Table

Leads and Payloads

Model	Motor output (W)	Maximum payload		Rated thrust (N)	Instantaneous maximum thrust (N)	Maximum acceleration (G)	Positioning repeatability (mm)	Stroke (mm)
		Horizontal (kg)	Vertical (kg)					
RCL-SM5L-I-5-N-①-②-③	5	See chart above	—	5	18	2	±0.1	36 to 144 (set in 36mm increments)

Legend ① Stroke ② Compatible Controllers ③ Cable length

Stroke and Maximum Speed

Lead	Stroke	36 to 144 (set in 36mm increments)
	(no screw)	1400

(unit: mm/s)

① Stroke list

Stroke (mm)	Standard price
36	—
72	—
108	—
144	—

③ Cable Length

Type	Cable symbol	Standard price
Standard type (Robot cable)	P (1m)	—
	S (3m)	—
	M (5m)	—
Special length	X06 (6m) ~ X10 (10m)	—
	X11 (11m) ~ X15 (15m)	—
	X16 (16m) ~ X20 (20m)	—

* The standard cable for the RCL is the robot cable.

Actuator Specifications

Item	Description
Drive System	Linear servo motor
Encoder resolution	0.042mm
Base	Material: Aluminum, white alumite treated
Dynamic allowable moment (Note)	Ma: 0.49 N·m Mb: 0.41 N·m Mc: 0.72 N·m
Overhung load length	Ma direction: 80mm or less, Mb and Mc directions: 100mm or less
Ambient operating temperature, humidity	0 to 40°C, 85% RH or less (Non-condensing)

(Note) For case of 5,000km service life.

Dimensional Drawings

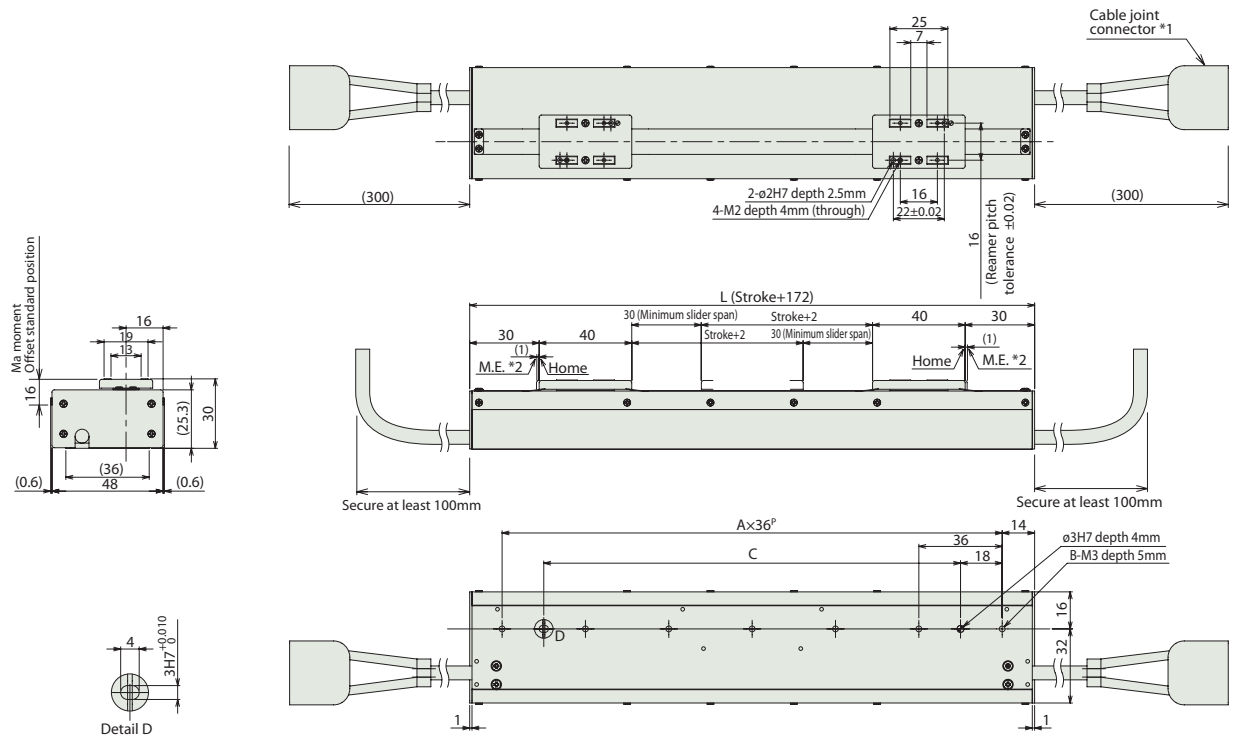

ME: Mechanical end
SE: Stroke end

- *1 The motor and encoder cable are attached.
- *2 During home return, the slider travels until the mechanical end, so be careful to avoid interference from peripheral objects.

Note
One controller is required for each slider.
(Or, one 2-axis controller is required.)

■ Dimensions and Weight by Stroke

Stroke	36	72	108	144
L	208	244	280	316
A	5	6	7	8
B	6	7	8	9
C	144	180	216	252
Mass (kg)	0.62	0.69	0.75	0.82

② Compatible Controllers

RCL series actuators can be operated with the controllers indicated below. Select the type according to your intended application.

Title	External View	Model	Features	Maximum number of positioning points	Input power	Power-supply capacity	Standard price	Reference Page
Solenoid valve type		AMEC-C-5I-NP-2-1	Easy-to-use controller, even for beginners	3 points	AC100V	Rated: 2.4A	-	→ P131
Splash-proof solenoid type		ASEP-C-5I-NP-2-0	Operable with the same signal as a solenoid valve. Supports both single and double solenoid types. No homing necessary with the simple absolute type.					
Positioner type		ACON-C-5I-NP-2-0	Up to 512 positioning points are supported.	512 points	DC24V	Maximum: 6.4A	-	See the ROBO Cylinder general catalog
Safety-compliant positioner type		ACON-CG-5I-NP-2-0						
Pulse-train input type (Differential line driver)		ACON-PL-5I-NP-2-0	Pulse-train input type with differential line driver support	(-)	DC24V	Maximum: 6.4A	-	See the ROBO Cylinder general catalog
Pulse-train input type (Open collector)		ACON-PO-5I-NP-2-0	Pulse-train input type with open collector support					
Serial communication type		ACON-SE-5I-N-0-0	Dedicated to serial communication	64 points	DC24V	Maximum: 6.4A	-	See the ROBO Cylinder general catalog
Field network type		RACON-5	Dedicated to a field network	768 points				
Program control type		ASEL-C-2-5I-5I-NP-2-0	Program operation is supported. Up to two axes can be operated.	1500 points	DC24V	Maximum: 12.8A	-	See the ROBO Cylinder general catalog



RCL-SA6L

ROBO Cylinder Mini Linear Servo Type Micro Slider Long Stroke Type Actuator Width 58 mm
Linear servo motor

Model Description	RCL — SA6L — I — 10 — N — <input type="checkbox"/> — <input type="checkbox"/> — <input type="checkbox"/> — <input type="checkbox"/>							
Series	Type	Encoder type	Motor type	Lead	Stroke	Compatible controllers	Cable length	Option
		I: Incremental specification	10: Linear servo motor 10W	N: No screw	48: 48mm 288: 288mm (set in steps every 48mm)	A1:ACON RACON ASEL A3:AMEC ASEP	N: None P: 1 m S: 3 m M: 5 m X□□: Length Designation	NM: Reversed-home specification

* See page 14 for details on the model descriptions.

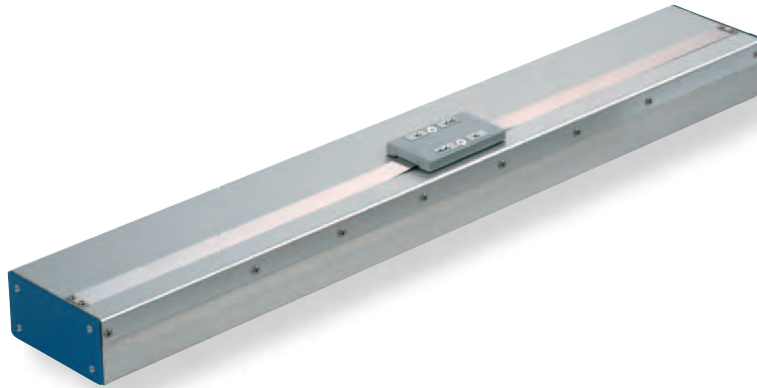

Relation between payload (horizontal) and acceleration

Maximum Acceleration (G)	Load Capacity (kg)
	Continuous operation (Duty is 100%)
0.1	3.2
0.3	
0.5	2
1	1
1.5	0.65
2	0.5



- (1) Please take care because this type has magnetic flux leakage. (If magnetism is a problem, use SA1L/SA2L/SA3L)
- (2) The payload is determined by the acceleration and duty. Verify the payload in the payload (horizontal) and acceleration chart at right.
The duty is $\frac{\text{Operating time}}{\text{Operating time} + \text{stop time}} \times 100$ per cycle.
- (3) The mounting position is horizontal-only. Please take care because the slider will drop down with power OFF when operating vertically.
- (4) Simple absolute unit cannot be used with the RCL series.

Actuator Specifications Table

Leads and Payloads

Model	Motor output (W)	Maximum payload		Rated thrust (N)	Instantaneous maximum thrust (N)	Maximum acceleration (G)	Positioning repeatability (mm)	Stroke (mm)
		Horizontal (kg)	Vertical (kg)					
RCL-SA6L-I-10-N-①-②-③-④	10	See chart above	—	10	30	2	±0.1	48 to 288 (set in 48mm increments)

Legend ① Stroke ② Compatible Controllers ③ Cable length ④ Option

Stroke and Maximum Speed

Lead	Stroke	48 to 288 (set in 48mm increments)
	(no screw)	1600

(unit: mm/s)

① Stroke list

Stroke (mm)	Standard price
48	—
96	—
144	—
192	—
240	—
288	—

③ Cable Length

Type	Cable symbol	Standard price
Standard type (Robot cable)	P (1m)	—
	S (3m)	—
	M (5m)	—
Special length	X06 (6m) ~ X10 (10m)	—
	X11 (11m) ~ X15 (15m)	—
	X16 (16m) ~ X20 (20m)	—

* The standard cable for the RCL is the robot cable.

④ Options

Title	Option code	See page	Standard price
Reversed-home specification	NM	—	—

Actuator Specifications

Item	Description
Drive System	Linear servo motor
Encoder resolution	0.042mm
Base	Material: Aluminum, white alumite treated
Dynamic allowable moment (Note)	Ma: 0.87 N·m Mb: 0.75 N·m Mc: 1.22 N·m
Overhung load length	Ma direction: 80mm or less, Mb and Mc directions: 120mm or less
Ambient operating temperature, humidity	0 to 40°C, 85% RH or less (Non-condensing)

(Note) For case of 5,000km service life.

Dimensional Drawings

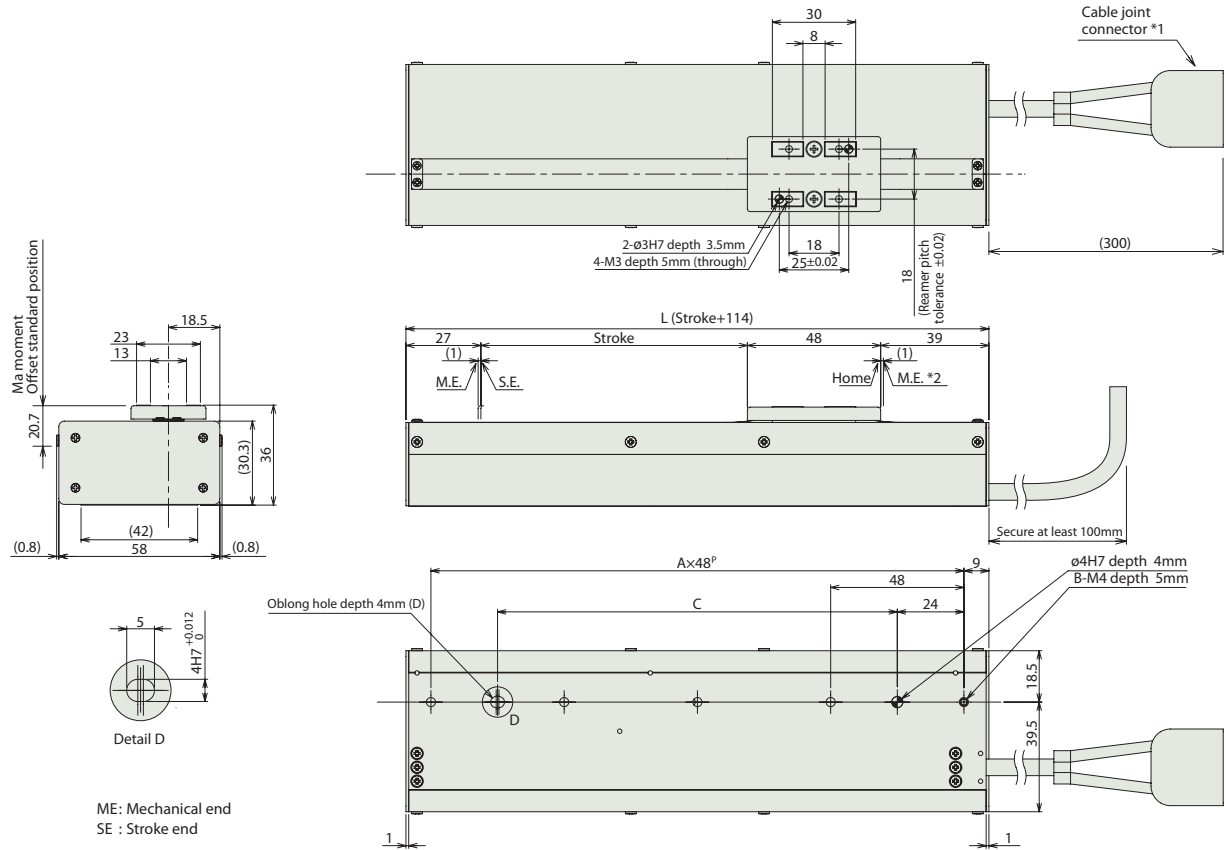

ME: Mechanical end
SE : Stroke end

- *1 The motor and encoder cable are attached.
- *2 During home return, the slider travels until the mechanical end, so be careful to avoid interference from peripheral objects.

■ Dimensions and Weight by Stroke

Stroke	48	96	144	192	240	288
L	162	210	258	306	354	402
A	3	4	5	6	7	8
B	4	5	6	7	8	9
C	96	144	192	240	288	336
Mass (kg)	0.67	0.8	0.93	1.07	1.2	1.34

② Compatible Controllers

RCL series actuators can be operated with the controllers indicated below. Select the type according to your intended application.

Title	External View	Model	Features	Maximum number of positioning points	Input power	Power-supply capacity	Standard price	Reference Page
Solenoid valve type		AMEC-C-10I-NP-2-1	Easy-to-use controller, even for beginners	3 points	AC100V	Rated: 2.4A	-	→ P131
Splash-proof solenoid type		ASEP-C-10I-NP-2-0	Operable with the same signal as a solenoid valve. Supports both single and double solenoid types. No homing necessary with the simple absolute type.					→ P141
Positioner type		ACON-C-10I-NP-2-0	Up to 512 positioning points are supported.	512 points	DC24V	Maximum: 6.4A	-	See the ROBO Cylinder general catalog
Safety-compliant positioner type		ACON-CG-10I-NP-2-0						
Pulse-train input type (Differential line driver)		ACON-PL-10I-NP-2-0	Pulse-train input type with differential line driver support	(-)	DC24V	Maximum: 6.4A	-	
Pulse-train input type (Open collector)		ACON-PO-10I-NP-2-0						
Serial communication type		ACON-SE-10I-N-0-0	Dedicated to serial communication	64 points	DC24V	Maximum: 6.4A	-	
Field network type		RACON-10	Dedicated to a field network	768 points				
Program control type		ASEL-C-1-10I-NP-2-0	Program operation is supported. Up to two axes can be operated.	1500 points	DC24V	Maximum: 6.4A	-	

*This is for the single-axis ASEL



RCL-SM6L

ROBO Cylinder Mini Linear Servo Type Multi Slider Long Stroke Type Actuator Width 58 mm
Linear servo motor

Model Description	RCL — SM6L — I — 10 — N — <input type="checkbox"/> — <input type="checkbox"/> — <input type="checkbox"/>				
Series	Type				
Encoder type	Motor type	Lead	Stroke	Compatible controllers	Cable length
I: Incremental specification	10: Linear servo motor 10W	N: No screw	48: 48mm 192: 192mm (set in steps every 48mm)	A1:ACON RACON ASEL A3:AMEC ASEP	N: None P: 1 m S: 3 m M: 5 m X□□: Length Designation

* See page 14 for details on the model descriptions.

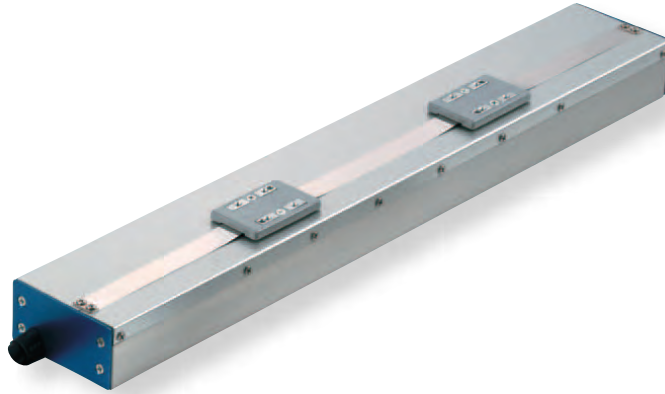

Relation between payload (horizontal) and acceleration

Maximum Acceleration (G)	Load Capacity (kg)	
	Continuous operation (Duty is 100%)	
0.1	3.2	
0.3		
0.5	2	
1	1	
1.5	0.65	
2	0.5	



- Please take care because this type has magnetic flux leakage. (If magnetism is a problem, use SA1L/SA2L/SA3L)
- The payload is determined by the acceleration and duty. Verify the payload in the payload (horizontal) and acceleration chart at right.
The duty is $\frac{\text{Operating time}}{\text{Operating time} + \text{stop time}} \times 100$ per cycle.
- The mounting position is horizontal-only. Please take care because the slider will drop down with power OFF when operating vertically.
- Simple absolute unit cannot be used with the RCL series.

Actuator Specifications Table

Leads and Payloads

Model	Motor output (W)	Maximum payload		Rated thrust (N)	Instantaneous maximum thrust (N)	Maximum acceleration (G)	Positioning repeatability (mm)	Stroke (mm)
		Horizontal (kg)	Vertical (kg)					
RCL-SM6L-I-10-N-①-②-③	10	See chart above	—	10	30	2	±0.1	48 to 192 (set in 48mm increments)

Legend ① Stroke ② Compatible Controllers ③ Cable length

Stroke and Maximum Speed

Lead	Stroke 48 to 192 (set in 48mm increments)	
	(no screw)	1600

(unit: mm/s)

① Stroke list

Stroke (mm)	Standard price
48	—
96	—
144	—
192	—

③ Cable Length

Type	Cable symbol	Standard price
Standard type (Robot cable)	P (1m)	—
	S (3m)	—
	M (5m)	—
Special length	X06 (6m) ~ X10 (10m)	—
	X11 (11m) ~ X15 (15m)	—
	X16 (16m) ~ X20 (20m)	—

* The standard cable for the RCL is the robot cable.

Actuator Specifications

Item	Description
Drive System	Linear servo motor
Encoder resolution	0.042mm
Base	Material: Aluminum, white alumite treated
Dynamic allowable moment (Note)	Ma: 0.87 N·m Mb: 0.75 N·m Mc: 1.22 N·m
Overhung load length	Ma direction: 80mm or less, Mb and Mc directions: 120mm or less
Ambient operating temperature, humidity	0 to 40°C, 85% RH or less (Non-condensing)

(Note) For case of 5,000km service life.

Dimensional Drawings

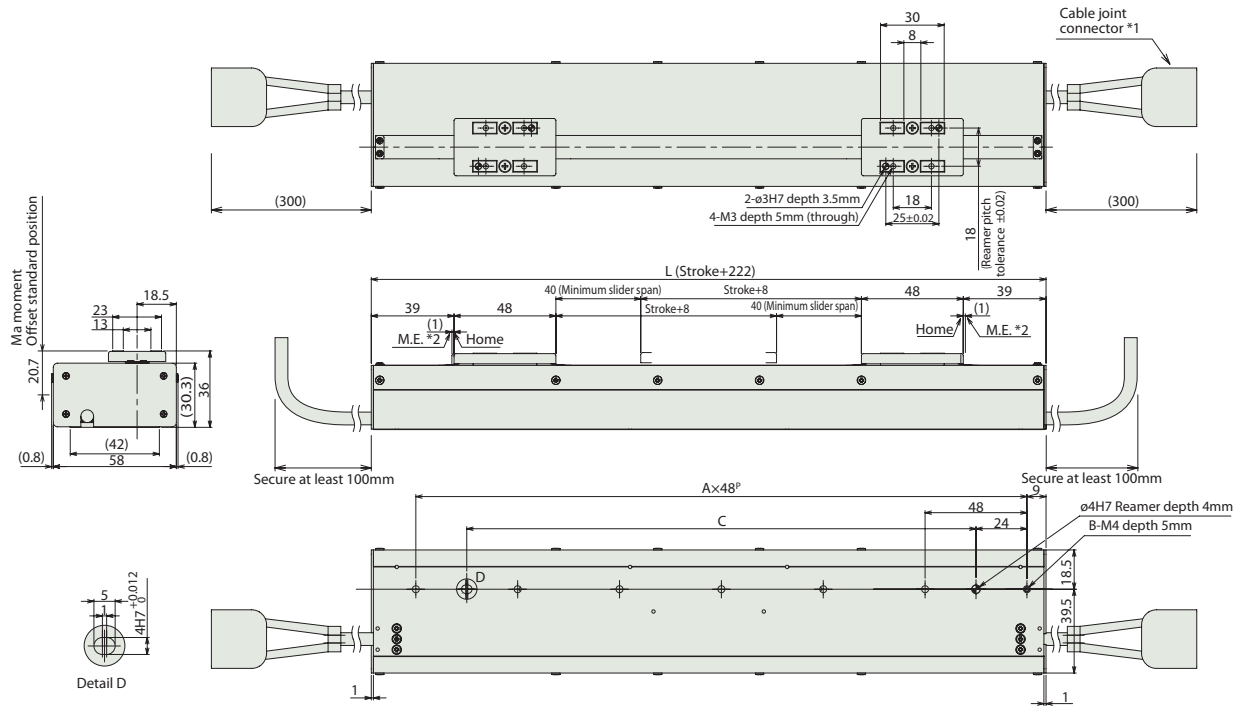

ME: Mechanical end
SE: Stroke end

- *1 The motor and encoder cable are attached.
- *2 During home return, the slider travels until the mechanical end, so be careful to avoid interference from peripheral objects.

Note
One controller is required for each slider.
(Or, one 2-axis controller is required.)

■ Dimensions and Weight by Stroke

Stroke	48	96	144	192
L	270	318	366	414
A	5	6	7	8
B	6	7	8	9
C	192	240	288	336
Mass (kg)	1.17	1.31	1.44	1.58

② Compatible Controllers

RCL series actuators can be operated with the controllers indicated below. Select the type according to your intended application.

Title	External View	Model	Features	Maximum number of positioning points	Input power	Power-supply capacity	Standard price	Reference Page
Solenoid valve type		AMEC-C-10I-NP-2-1	Easy-to-use controller, even for beginners	3 points	AC100V	Rated: 2.4A	-	→ P131
Splash-proof solenoid type		ASEP-C-10I-NP-2-0	Operable with the same signal as a solenoid valve. Supports both single and double solenoid types. No homing necessary with the simple absolute type.					
Positioner type		ACON-C-10I-NP-2-0	Up to 512 positioning points are supported.	512 points	DC24V	Maximum: 6.4A	-	See the ROBO Cylinder general catalog
Safety-compliant positioner type		ACON-CG-10I-NP-2-0						
Pulse-train input type (Differential line driver)		ACON-PL-10I-NP-2-0	Pulse-train input type with differential line driver support	(-)	DC24V	Maximum: 6.4A	-	See the ROBO Cylinder general catalog
Pulse-train input type (Open collector)		ACON-PO-10I-NP-2-0	Pulse-train input type with open collector support					
Serial communication type		ACON-SE-10I-N-0-0	Dedicated to serial communication	64 points	DC24V	Maximum: 6.4A	-	See the ROBO Cylinder general catalog
Field network type		RACON-10	Dedicated to a field network	768 points				
Program control type		ASEL-C-2-10I-10I-NP-2-0	Program operation is supported. Up to two axes can be operated.	1500 points	DC24V	Maximum: 12.8A	-	See the ROBO Cylinder general catalog



RCL-RA1L

ROBO Cylinder Mini Linear Servo Type Micro Cylinder Slim Type Main unit diameter: 16mm
Linear servo motor

Model Description	RCL — RA1L — I — 2 — N — 25 — <input type="checkbox"/> — <input type="checkbox"/> — <input type="checkbox"/>							
Series	Type	Encoder type	Motor type	Lead	Stroke	Compatible controllers	Cable length	Option
		1: Incremental specification	2: Linear servo motor ZW	N: No screw	25: 25mm	A1:ACON RACON ASEL A3:AMEC ASEP	N: None P: 1 m S: 3 m M: 5 m X□□: Length Designation	B : Brake (with brake box) BN: Brake (without brake box)

* See page 14 for details on the model descriptions.

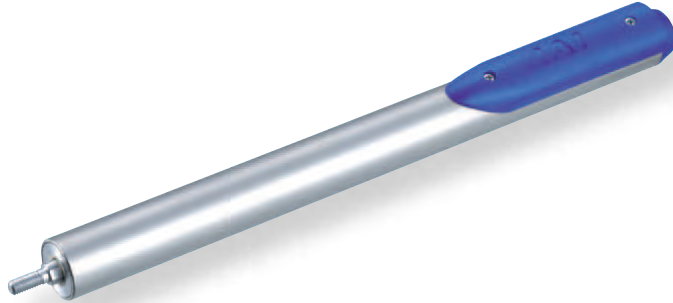

Relation between payload (horizontal) and acceleration

Maximum Acceleration (G)	Load Capacity (kg)			
	Continuous operation (Duty is 100%)		Duty is 70% or less	
	Horizontal	Vertical	Horizontal	Vertical
0.1	0.5	0.1	0.5	0.1
0.3				
0.5				
1	0.2		0.25	
1.5	0.11	—	0.15	—
2	0.07	—	0.1	—

Pushing force guidelines

Pushing operation is possible within the range of numeric values listed below. (N)

Electric current limit	30%	40%	50%	60%	70%	80%
Pushing force	0.75	1	1.25	1.5	1.75	2

(Note) The pushing forces listed above are for horizontal usage. If facing vertically upward, subtract 0.5N from the numeric values listed above, but if facing vertically downward, add 0.5N.

POINT
Notes on selection

(1) The payload is determined by the acceleration and duty.
Verify the payload in the payload (horizontal) and acceleration chart at right.
The duty is $\frac{\text{Operating time}}{\text{Operating time} + \text{stop time}} \times 100$ per cycle.

(2) If the actuator is operated vertically, use the optional brake specification.

(3) Please use an external guide to avoid a horizontal or rotational load applied to the rod.

(4) The pushing force fluctuation increases when the current limit is low.

(5) Simple absolute unit cannot be used with the RCL series.

Actuator Specifications Table

Leads and Payloads

Model	Motor output (W)	Maximum payload		Rated thrust (N)	Instantaneous maximum thrust (N)	Maximum acceleration (G)	Positioning repeatability (mm)	Stroke (mm)
		Horizontal (kg)	Vertical (kg)					
RCL-RA1L-I-2-N-25-①-②-③	2	See chart above	See chart above	2.5	10	Horizontal 2G Vertical 1G	±0.1	25 (Fixed)

Legend ① Compatible Controllers ② Cable length ③ Option

Stroke and Maximum Speed

Stroke	25 (mm)
Lead	
(no screw)	300

(unit: mm/s)

Stroke list

Stroke (mm)	Standard price
25	—

② Cable Length

Type	Cable symbol	Standard price
Standard type (Robot cable)	P (1m)	—
	S (3m)	—
	M (5m)	—
Special length	X06 (6m) ~ X10 (10m)	—
	X11 (11m) ~ X15 (15m)	—
	X16 (16m) ~ X20 (20m)	—

* The standard cable for the RCL is the robot cable.
* Refer to P. 155 for the cable for non-brake specification.
* Refer to P. 120 for the cable for brake specification.
(All prices represent the total of an integrated motor/encoder/brake cable and brake cable.)

③ Options

Title	Option code	See page	Standard price
Brake (with brake box)	B	—	—
Brake (without brake box)	BN	—	—

* The brake box and cable with brake is needed to use the brake. If only the actuator with brake is needed for a repair, specify the BN (specification without brake box).

Actuator Specifications

Item	Description
Drive System	Linear servo motor
Encoder resolution	0.042mm
Pipe	Material: Nickel-plated carbon steel tube
Ambient operating temperature, humidity	0 to 40°C, 85% RH or less (Non-condensing)
Service life	10 million cycles

Dimensional Drawings

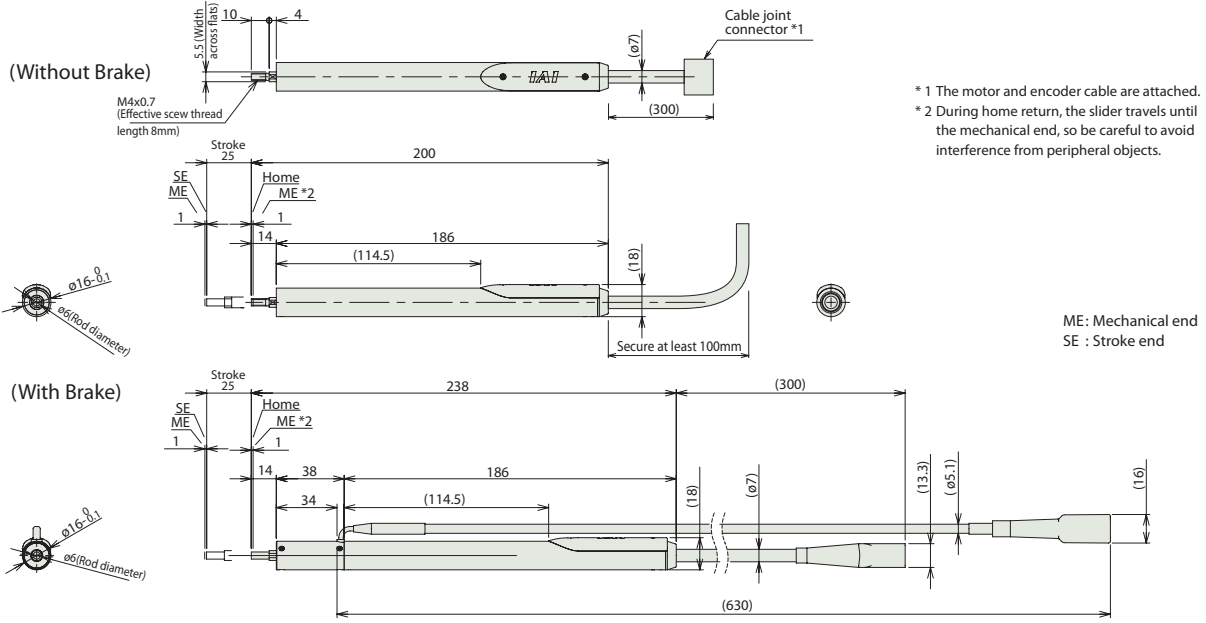

ME: Mechanical end
SE: Stroke end

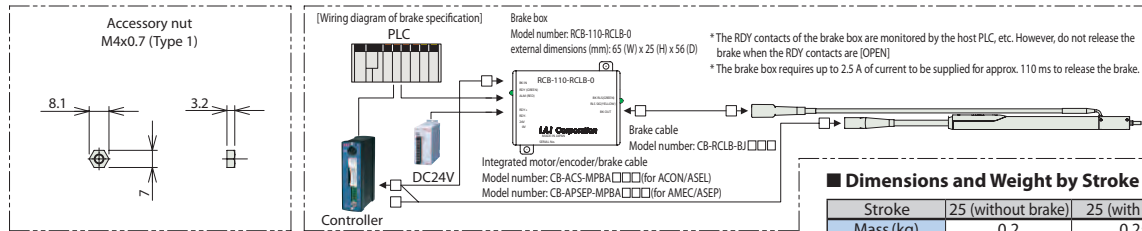

■ Dimensions and Weight by Stroke

Stroke	25 (without brake)	25 (with brake)
Mass (kg)	0.2	0.25

① Compatible Controllers

RCL series actuators can be operated with the controllers indicated below. Select the type according to your intended application.

Title	External View	Model	Features	Maximum number of positioning points	Input power	Power-supply capacity	Standard price	Reference Page
Solenoid valve type		AMEC-C-2I-NP-2-1	Easy-to-use controller, even for beginners	3 points	AC100V	Rated: 2.4A	-	→ P131
		ASEP-C-2I-NP-2-0	Operable with the same signal as a solenoid valve. Supports both single and double solenoid types. No homing necessary with the simple absolute type.					→ P141
Splash-proof solenoid type		ASEP-CW-2I-NP-2-0						
Positioner type		ACON-C-2I-NP-2-0	Up to 512 positioning points are supported.	512 points	DC24V	Maximum: 4.6A	-	See the ROBO Cylinder general catalog
Safety-compliant positioner type		ACON-CG-2I-NP-2-0						
Pulse-train input type (Differential line driver)		ACON-PL-2I-NP-2-0	Pulse-train input type with differential line driver support	(-)	DC24V	Maximum: 4.6A	-	See the ROBO Cylinder general catalog
Pulse-train input type (Open collector)		ACON-PO-2I-NP-2-0	Pulse-train input type with open collector support					
Serial communication type		ACON-SE-2I-N-0-0	Dedicated to serial communication	64 points				
Field network type		RACON-2	Dedicated to a field network	768 points				
Program control type		ASEL-C-1-2I-NP-2-0	Program operation is supported. Up to two axes can be operated.	1500 points				

* This is for the single-axis ASEL

RCL-RA2L

ROBO Cylinder Mini Linear Servo Type Micro Cylinder Slim Type Main unit diameter: 20mm
Linear servo motor

Model Description	RCL — RA2L — I — 5 — N — 30 — <input type="checkbox"/> — <input type="checkbox"/> — <input type="checkbox"/>
Series	Type
Encoder type	Motor type
Lead	Stroke
Compatible controllers	Cable length
Option	
I: Incremental specification	S: Linear servo motor 5W
N: No screw	30: 30mm
A1: ACON RACON ASEL A3: AMEC ASEP	N: None P: 1 m S: 3 m M: 5 m X□□: Length Designation
B : Brake (with brake box) BN: Brake (without brake box)	

* See page 14 for details on the model descriptions.

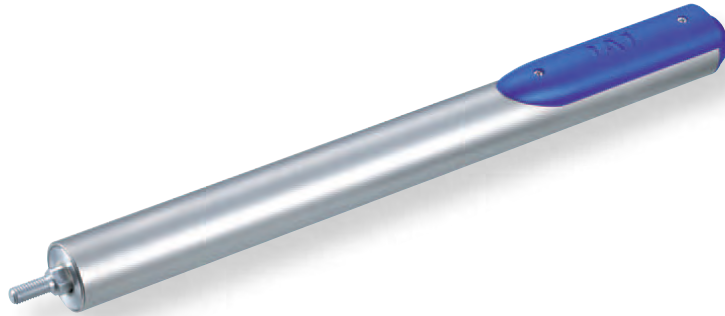

Relation between payload (horizontal) and acceleration

Maximum Acceleration (G)	Load Capacity (kg)			
	Continuous operation (Duty is 100%)		Duty is 70% or less	
	Horizontal	Vertical	Horizontal	Vertical
0.1	1	0.2	1	0.2
0.3				
0.5	0.85		0.5	
1	0.4			
1.5	0.24	—	0.3	—
2	0.15	—	0.2	—

Pushing force guidelines

Pushing operation is possible within the range of numeric values listed below. (N)

Electric current limit	30%	40%	50%	60%	70%	80%
Pushing force	1.5	2	2.5	3	3.5	4

(Note) The pushing forces listed above are for horizontal usage. If facing vertically upward, subtract 1N from the numeric values listed above, but if facing vertically downward, add 1N.

POINT
Notes on selection

(1) The payload is determined by the acceleration and duty.
Verify the payload in the payload (horizontal) and acceleration chart at right.
The duty is $\frac{\text{Operating time}}{\text{Operating time} + \text{stop time}} \times 100$ per cycle.

(2) If the actuator is operated vertically, use the optional brake specification.

(3) Please use an external guide to avoid a horizontal or rotational load applied to the rod.

(4) The pushing force fluctuation increases when the current limit is low.

(5) Simple absolute unit cannot be used with the RCL series.

Actuator Specifications Table

Leads and Payloads

Model	Motor output (W)	Maximum payload		Rated thrust (N)	Instantaneous maximum thrust (N)	Maximum acceleration (G)	Positioning repeatability (mm)	Stroke (mm)
		Horizontal (kg)	Vertical (kg)					
RCL-RA2L-I-5-N-30-①-②-③	5	See chart above	See chart above	5	18	Horizontal 2G Vertical 1G	±0.1	30 (Fixed)

Legend ① Compatible Controllers ② Cable length ③ Option

Stroke and Maximum Speed

Stroke	30 (mm)
(no screw)	340

(unit: mm/s)

Stroke list

Stroke (mm)	Standard price
30	—

② Cable Length

Type	Cable symbol	Standard price
Standard type (Robot cable)	P (1m)	—
	S (3m)	—
	M (5m)	—
Special length	X06 (6m) ~ X10 (10m)	—
	X11 (11m) ~ X15 (15m)	—
	X16 (16m) ~ X20 (20m)	—

* The standard cable for the RCL is the robot cable.
* Refer to P. 155 for the cable for non-brake specification.
* Refer to P. 120 for the cable for brake specification.
(All prices represent the total of an integrated motor/encoder/brake cable and brake cable.)

③ Options

Title	Option code	See page	Standard price
Brake (with brake box)	B	—	—
Brake (without brake box)	BN	—	—

* The brake box and cable with brake is needed to use the brake. If only the actuator with brake is needed for a repair, specify the BN (specification without brake box).

Actuator Specifications

Item	Description
Drive System	Linear servo motor
Encoder resolution	0.042mm
Pipe	Material: Nickel-plated carbon steel tube
Ambient operating temperature, humidity	0 to 40°C, 85% RH or less (Non-condensing)
Service life	10 million cycles

Dimensional Drawings

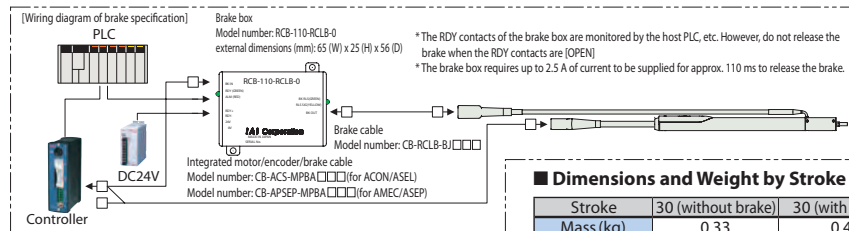
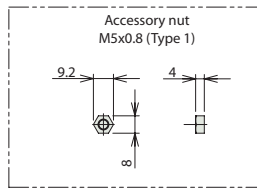
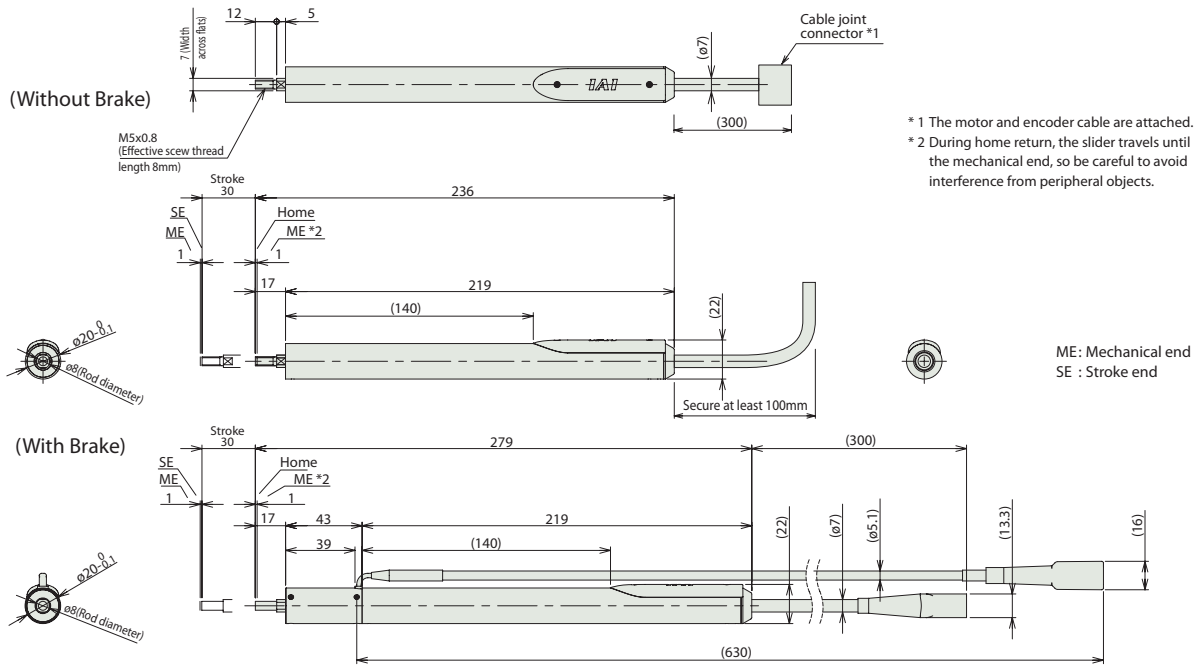

Dimensions and Weight by Stroke

Stroke	30 (without brake)	30 (with brake)
Mass (kg)	0.33	0.4

① Compatible Controllers

RCL series actuators can be operated with the controllers indicated below. Select the type according to your intended application.

Title	External View	Model	Features	Maximum number of positioning points	Input power	Power-supply capacity	Standard price	Reference Page
Solenoid valve type		AMEC-C-5I-NP-2-1	Easy-to-use controller, even for beginners	3 points	AC100V	Rated: 2.4A	-	→ P131
		ASEP-C-5I-NP-2-0	Operable with the same signal as a solenoid valve. Supports both single and double solenoid types. No homing necessary with the simple absolute type.					→ P141
Splash-proof solenoid type		ASEP-CW-5I-NP-2-0						
Positioner type		ACON-C-5I-NP-2-0	Up to 512 positioning points are supported.	512 points				-
Safety-compliant positioner type		ACON-CG-5I-NP-2-0						-
Pulse-train input type (Differential line driver)		ACON-PL-5I-NP-2-0	Pulse-train input type with differential line driver support	(-)	DC24V	Maximum: 6.4A		See the ROBO Cylinder general catalog
Pulse-train input type (Open collector)		ACON-PO-5I-NP-2-0	Pulse-train input type with open collector support					
Serial communication type		ACON-SE-5I-N-0-0	Dedicated to serial communication	64 points				
Field network type		RACON-5	Dedicated to a field network	768 points				
Program control type		ASEL-C-1-5I-NP-2-0	Program operation is supported. Up to two axes can be operated.	1500 points				

*This is for the single-axis ASEL

RCL-RA3L

ROBO Cylinder Mini Linear Servo Type Micro Cylinder Slim Type Main unit diameter: 25mm
Linear servo motor

Model Description	RCL — RA3L — I — 10 — N — 40 — <input type="checkbox"/> — <input type="checkbox"/> — <input type="checkbox"/>							
Series	Type	Encoder type	Motor type	Lead	Stroke	Compatible controllers	Cable length	Option
		I: Incremental specification	10: Linear servo motor 10W	N: No screw	40: 40mm	A1:ACON RACON ASEL A3:AMEC ASEP	N: None P: 1 m S: 3 m M: 5 m X□□: Length Designation	B : Brake (with brake box) BN: Brake (without brake box)

* See page 14 for details on the model descriptions.

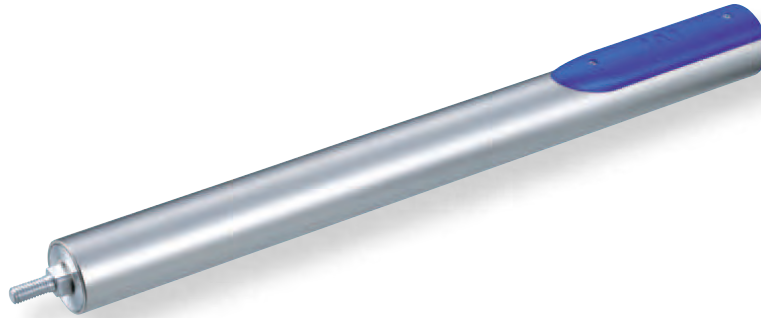

Relation between payload (horizontal) and acceleration

Maximum Acceleration (G)	Load Capacity (kg)			
	Continuous operation (Duty is 100%)		Duty is 70% or less	
	Horizontal	Vertical	Horizontal	Vertical
0.1	2	0.4	2	0.4
0.3				
0.5	1.6	—	1	—
1	0.78		0.6	
1.5	0.46	—	0.4	—
2	0.3	—	—	—

Pushing force guidelines

Pushing operation is possible within the range of numeric values listed below. (N)

Electric current limit	30%	40%	50%	60%	70%	80%
Pushing force	3	4	5	6	7	8

(Note) The pushing forces listed above are for horizontal usage. If facing vertically upward, subtract 1.8N from the numeric values listed above, but if facing vertically downward, add 1.8N.

POINT
Notes on selection

(1) The payload is determined by the acceleration and duty.
Verify the payload in the payload (horizontal) and acceleration chart at right.
The duty is $\frac{\text{Operating time}}{\text{Operating time} + \text{stop time}} \times 100$ per cycle.

(2) If the actuator is operated vertically, use the optional brake specification.

(3) Please use an external guide to avoid a horizontal or rotational load applied to the rod.

(4) The pushing force fluctuation increases when the current limit is low.

(5) Simple absolute unit cannot be used with the RCL series.

Actuator Specifications Table

Leads and Payloads

Model	Motor output (W)	Maximum payload		Rated thrust (N)	Instantaneous maximum thrust (N)	Maximum acceleration (G)	Positioning repeatability (mm)	Stroke (mm)
		Horizontal (kg)	Vertical (kg)					
RCL-RA3L-I-10-N-40-①-②-③	10	See chart above	See chart above	10	30	Horizontal 2G Vertical 1G	±0.1	40 (Fixed)

Legend ① Compatible Controllers ② Cable length ③ Option

Stroke and Maximum Speed

Stroke	40 (mm)
(no screw)	450

(unit: mm/s)

Stroke list

Stroke (mm)	Standard price
40	—

② Cable Length

Type	Cable symbol	Standard price
Standard type (Robot cable)	P (1m)	—
	S (3m)	—
	M (5m)	—
Special length	X06 (6m) ~ X10 (10m)	—
	X11 (11m) ~ X15 (15m)	—
	X16 (16m) ~ X20 (20m)	—

* The standard cable for the RCL is the robot cable.
* Refer to P. 155 for the cable for non-brake specification.
* Refer to P. 120 for the cable for brake specification.
(All prices represent the total of an integrated motor/encoder/brake cable and brake cable.)

③ Options

Title	Option code	See page	Standard price
Brake (with brake box)	B	—	—
Brake (without brake box)	BN	—	—

* The brake box and cable with brake is needed to use the brake. If only the actuator with brake is needed for a repair, specify the BN (specification without brake box).

Actuator Specifications

Item	Description
Drive System	Linear servo motor
Encoder resolution	0.042mm
Pipe	Material: Nickel-plated carbon steel tube
Ambient operating temperature, humidity	0 to 40°C, 85% RH or less (Non-condensing)
Service life	10 million cycles

Dimensional Drawings

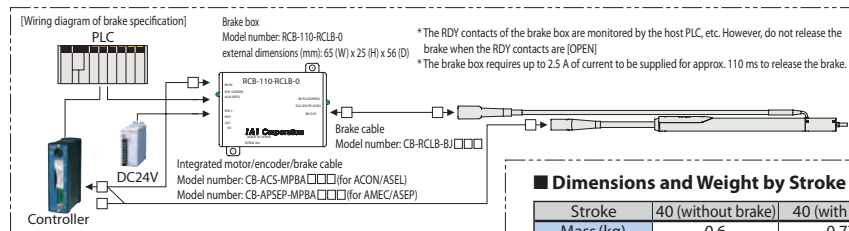
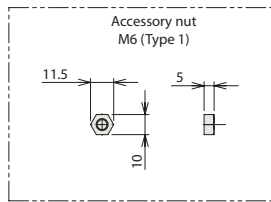
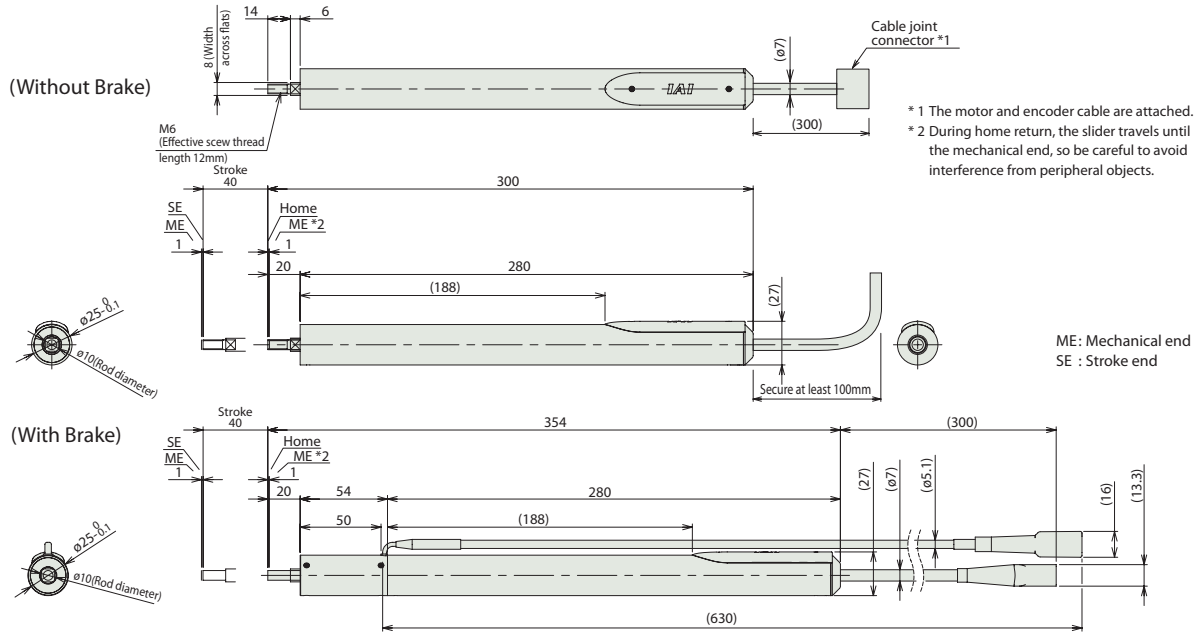

■ Dimensions and Weight by Stroke

Stroke	40 (without brake)	40 (with brake)
Mass (kg)	0.6	0.77

① Compatible Controllers

RCL series actuators can be operated with the controllers indicated below. Select the type according to your intended application.

Title	External View	Model	Features	Maximum number of positioning points	Input power	Power-supply capacity	Standard price	Reference Page
Solenoid valve type		AMEC-C-10I-NP-2-1	Easy-to-use controller, even for beginners	3 points	AC100V	Rated: 2.4A	-	→ P131
		ASEP-C-10I-NP-2-0	Operable with the same signal as a solenoid valve. Supports both single and double solenoid types. No homing necessary with the simple absolute type.					→ P141
Splash-proof solenoid type		ASEP-CW-10I-NP-2-0						
Positioner type		ACON-C-10I-NP-2-0	Up to 512 positioning points are supported.	512 points	DC24V	Maximum: 6.4A	-	See the ROBO Cylinder general catalog
Safety-compliant positioner type		ACON-CG-10I-NP-2-0						
Pulse-train input type (Differential line driver)		ACON-PL-10I-NP-2-0	Pulse-train input type with differential line driver support	(-)	DC24V	Maximum: 6.4A	-	See the ROBO Cylinder general catalog
Pulse-train input type (Open collector)		ACON-PO-10I-NP-2-0	Pulse-train input type with open collector support					
Serial communication type		ACON-SE-10I-N-0-0	Dedicated to serial communication	64 points				
Field network type		RACON-10	Dedicated to a field network	768 points				
Program control type		ASEL-C-1-10I-NP-2-0	Program operation is supported. Up to two axes can be operated.	1500 points				

* This is for the single-axis ASEL

Selection Guide (Push force and current limiting value correlation graph)

Use the following models for push-motion operation.

The push force applied in push-motion operation can be freely set by changing the current-limiting value in the controller.

The push force setting ranges differ according to type. Use the following chart to verify.

RCL Series

Micro Cylinder

● Setting the current limiting value in push-motion operation

For push-motion operation, set the current limiting values that determine push force. *The push force is an approximate standard, so it will vary somewhat. *The push time is not limited. Continuous pushing is possible.

Standard for push force

[N]

Current limiting value	30%	40%	50%	60%	70%	80%
RA1L	0.75	1	1.25	1.5	1.75	2
RA2L	1.5	2	2.5	3	3.5	4
RA3L	3	4	5	6	7	8

Caution

- Depending on the teaching pendant version or the PC software, the current limiting value can be set within 71% to 80%. Be sure to read the "Caution" section shown at the beginning of the manual.
- Movement speed during push operation is fixed at 20mm/s.

Effect by push direction

Horizontal



Push force = Thrust
 $F=f$

Vertical (downward push)

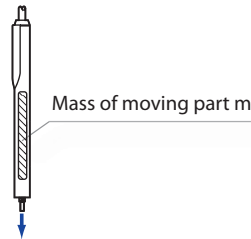

Push force = Thrust + Mass of moving part
 $F=f+M$

Vertical (upward push)

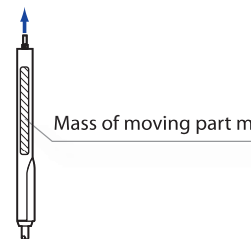

Push force = Thrust - Mass of moving part
 $F=f-M$

Mass of moving part

Model	Mass of moving part [N]
RA1L	0.5
RA2L	1
RA3L	1.8

RCP3 Series

Mini Rod Type (RA2AC/RA2BC/RA2AR/RA2BR)

* The red line ranges are specification values.

For push-motion operation, select the model with the desired push force that falls within the range of the red line in the graph below.

Caution

■ Movement speed during push operation is fixed at 5mm/s.

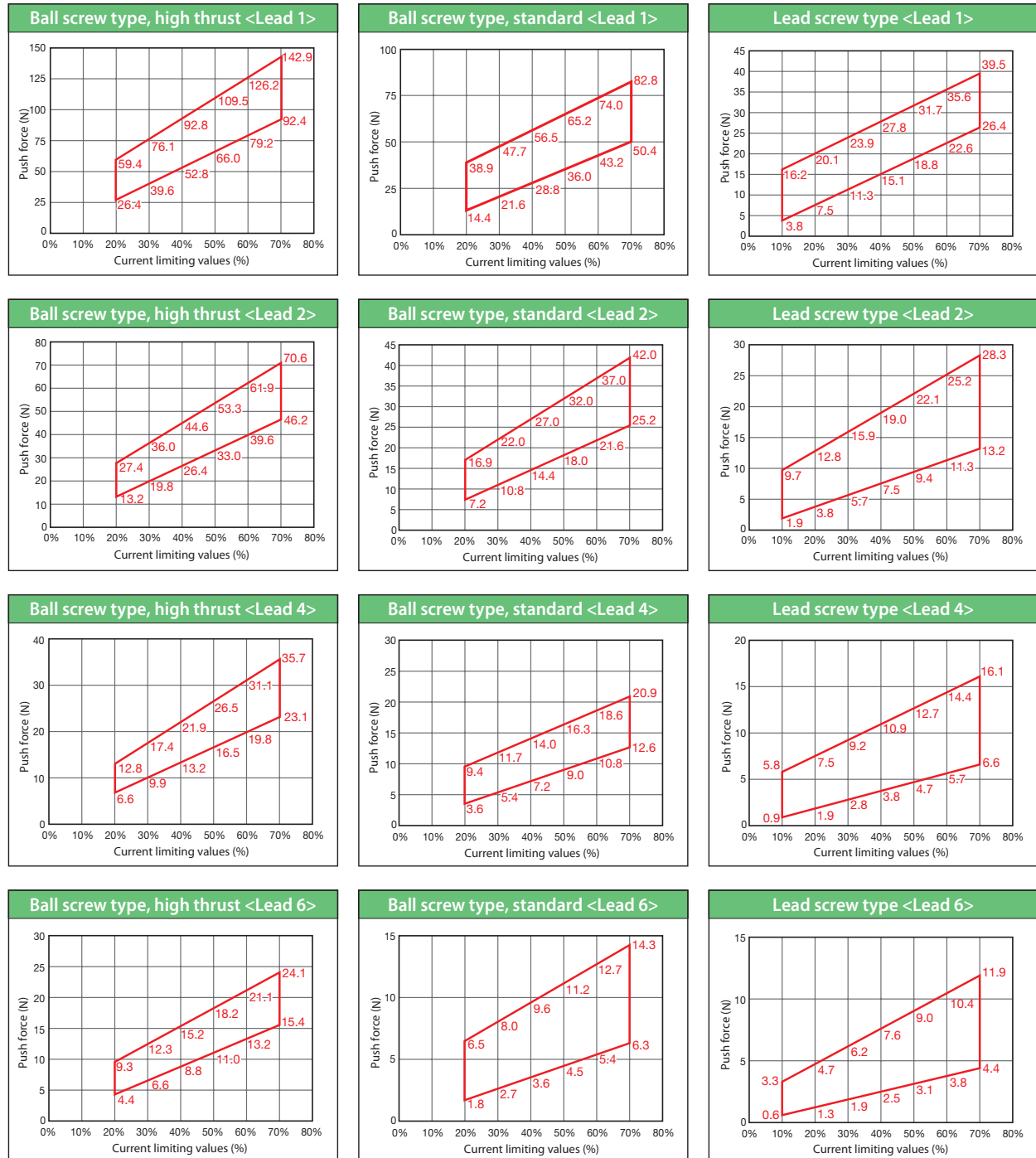

Selection Guide (Push force and current limiting value correlation graph)

RCP3 Series

Mini Table type

When using the table type for a push operation, limit the pushing current to ensure that the reaction moment generated by the push force does not exceed the catalog specification rated moment (M_a , M_b) of 80%.

Refer to the figure below for the operation position for moment calculations.

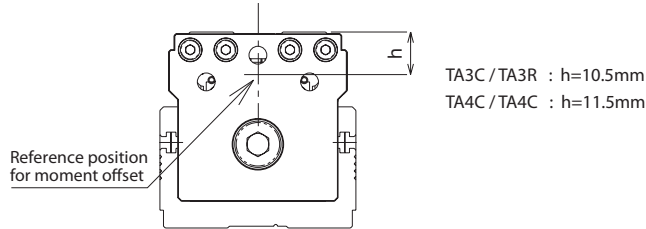

Caution

- Movement speed during push operation is fixed at 20mm/s.
- The push force is an approximate standard, so it will vary somewhat.

When using a slider type for a push operation, limit the pushing current to ensure that the reaction moment generated by the push force does not exceed the catalog specification **rated moment of 80%**.

Example of calculation:

When pushing at 44N at the position in the chart on the right using RCP3-TA4C (Lead 2) type:

The guide moment is

$$M_a = (11.5 + 30) \times 44$$

$$= 1826 \text{ (N-mm)}$$

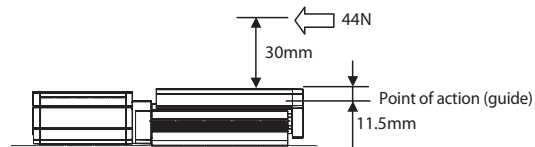
$$= 1.826 \text{ (N-m)}$$

The TA4C allowable dynamic moment (M_a) is 4.2 (N-m), which means 80% is 3.36.

Therefore, a moment load greater than that actually received by the guide (1.826) can be used.

Push force and current limiting value correlation graph

Standard figures are shown in the table below. Actual figures will differ slightly.

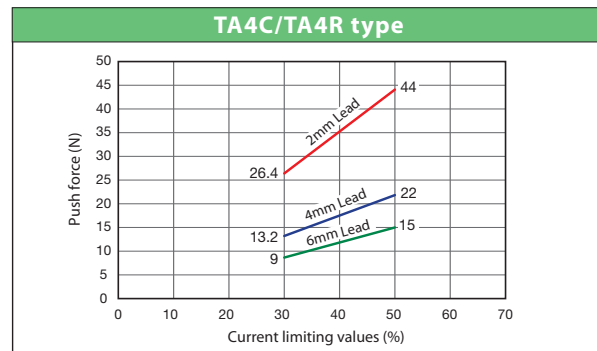
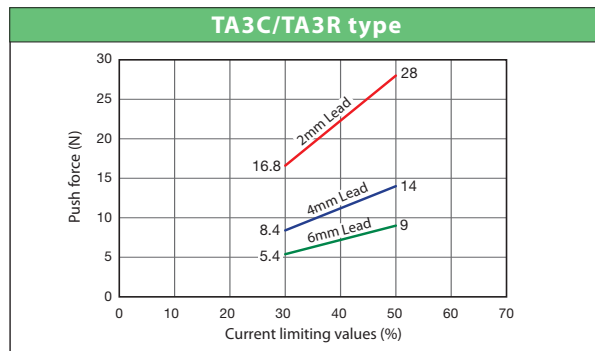

Selection Guide (Information on Guide Type)

Load Moment and Reference Service Life

Actuators of mini slider type (RCA2-SA2AC/SA2AR) have a built-in guide, so they can receive a load overhanging from the slider. Note, however, that the service life of the actuator will decrease if the specified dynamic allowable moment is exceeded. (See the graphs below.)

When calculating this moment, use a point 25 mm below the top surface of the slider as the reference point. See the illustration at the bottom of this page.

Even when the allowable moment is not breached, keep the overhang length from the actuator (overhang length) within 40 mm.

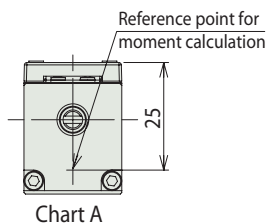
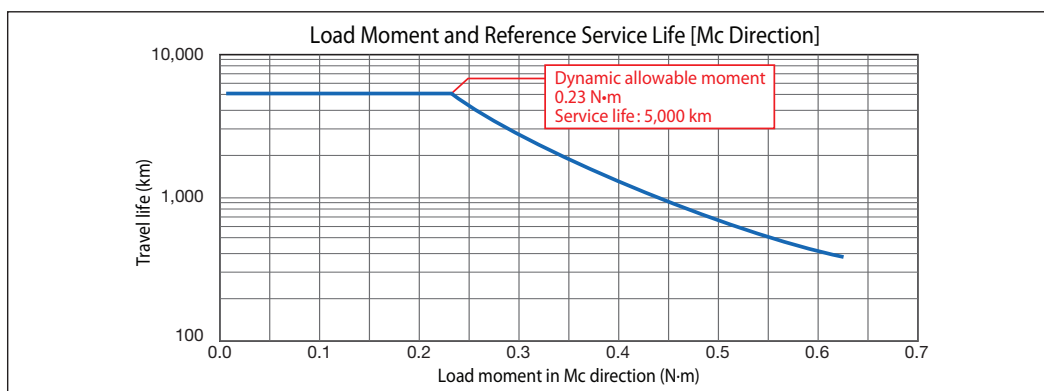
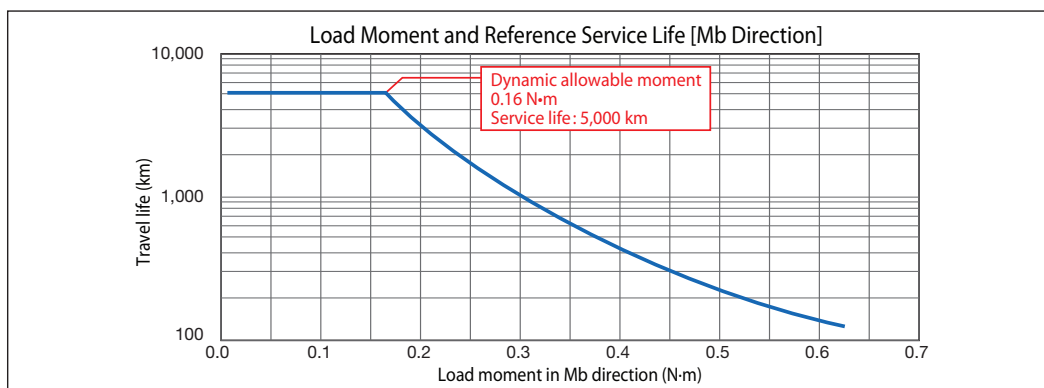
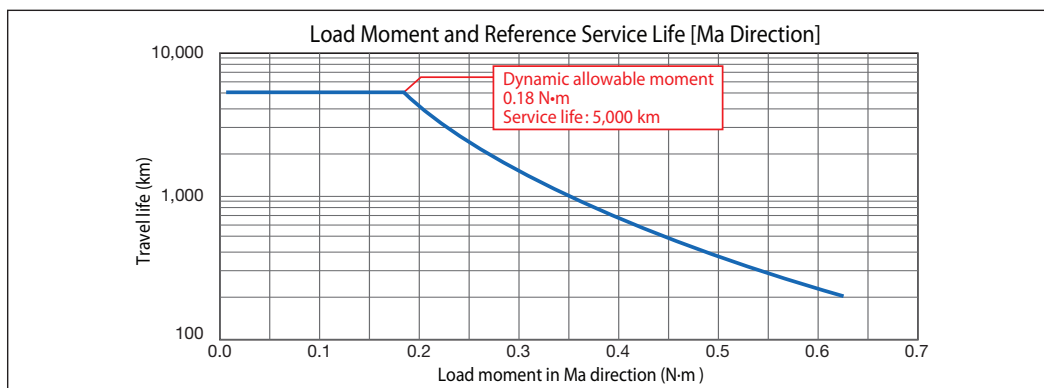

Directions of allowable load moments

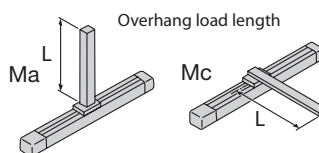
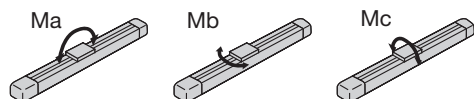

Allowable Rotating Torque

The allowable torque for each model is specified below.

When rotational torque is exerted, use within the range of values specified below. Please note that single-guide types cannot be subjected to rotational torque.

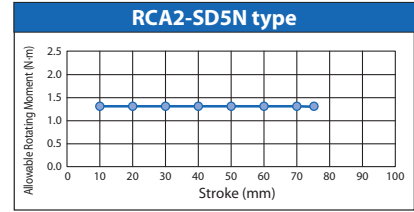
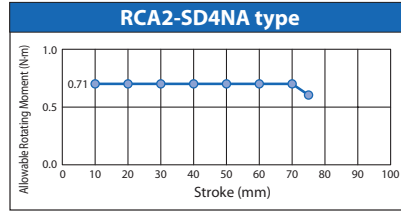
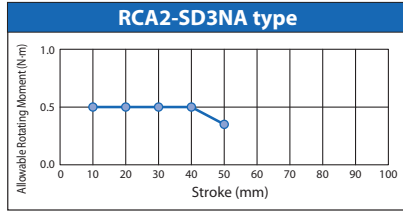
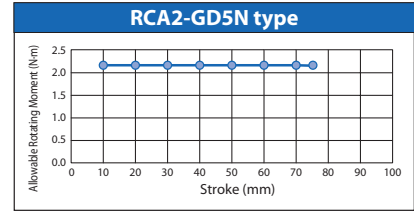
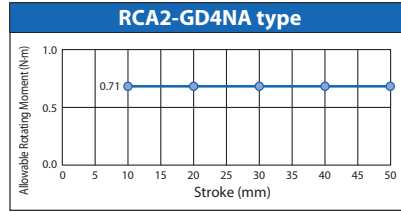
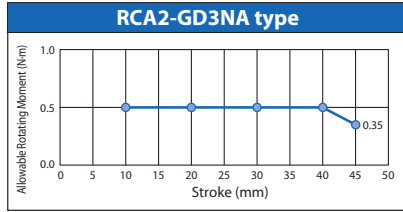

Relationship Between Allowable Load at Tip & Running Service Life

The greater the load at the guide tip, the shorter the running service life.
Select the appropriate model while considering the balance between load and service life.

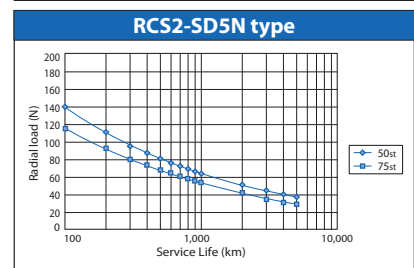
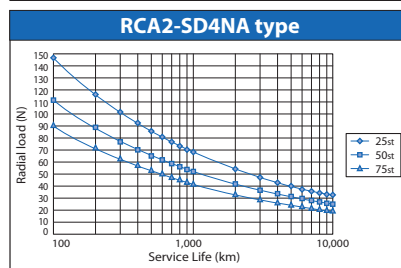
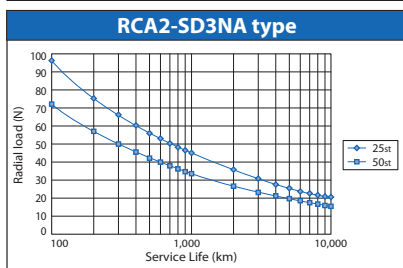
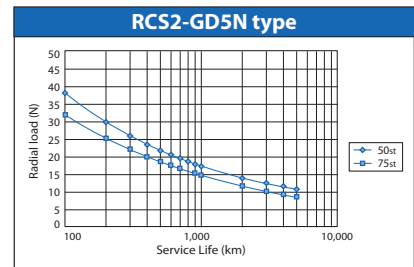
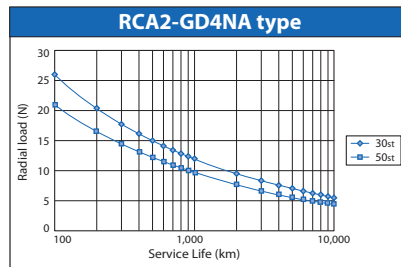
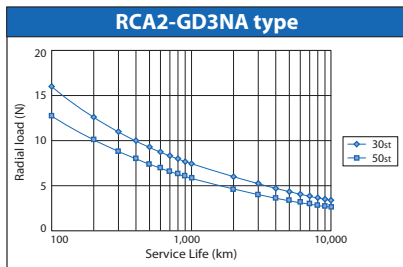
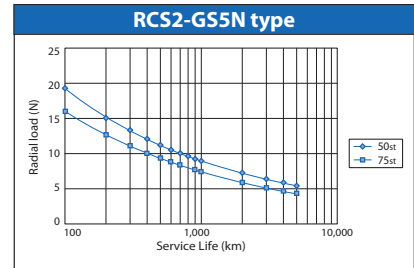
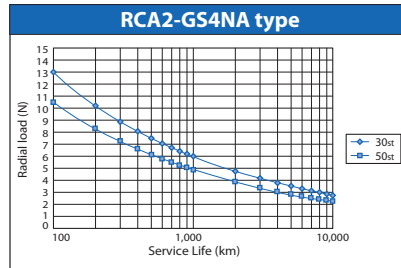
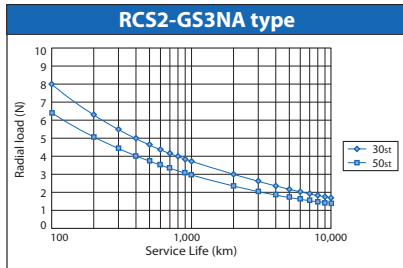
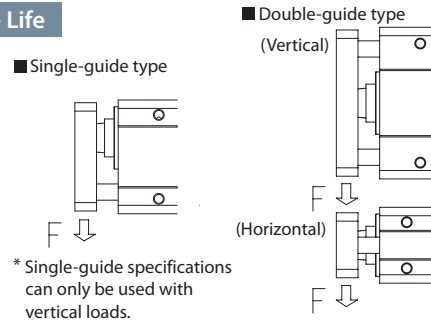

Radial Load & Tip Deflection

The graphs below show the correlation between the load exerted at the guide tip and the amount of deflection generated.

■ Single-guide type

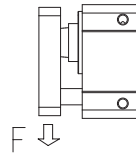

■ Double-guide type

(Vertical)

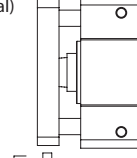

(Horizontal)

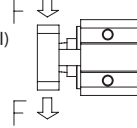

* Single-guide specifications can only be used with vertical loads.

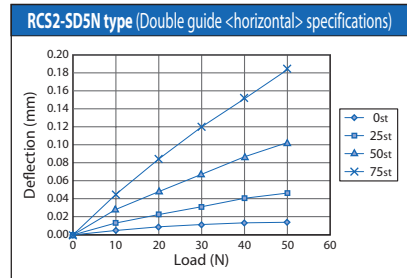
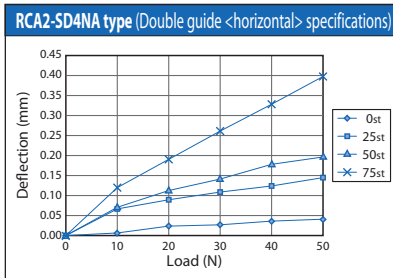
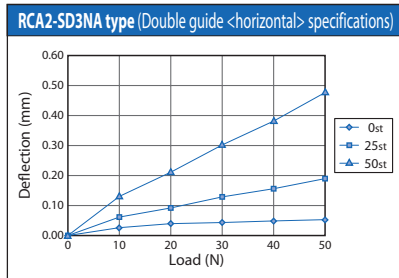
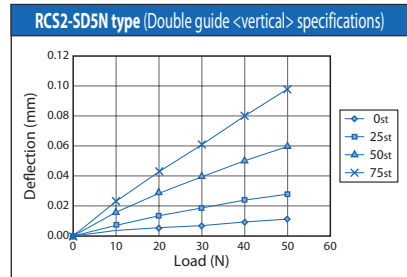
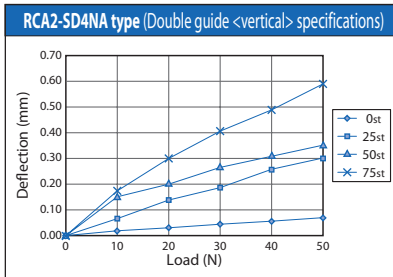
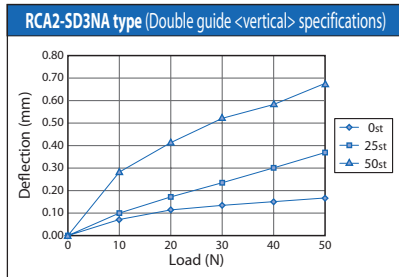
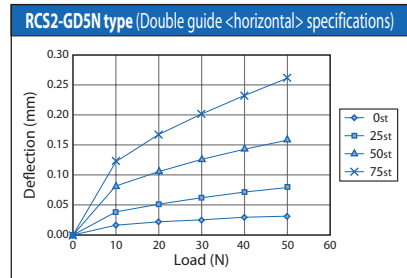
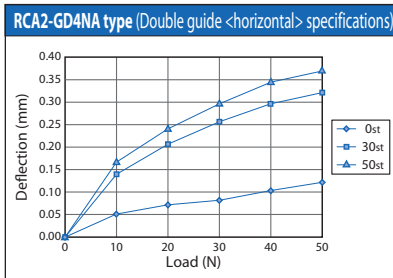
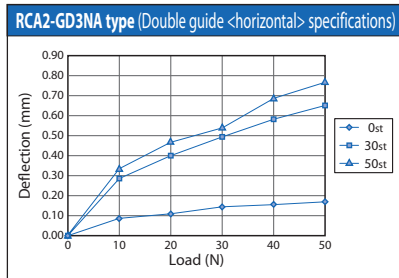
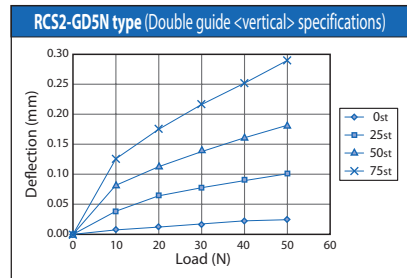
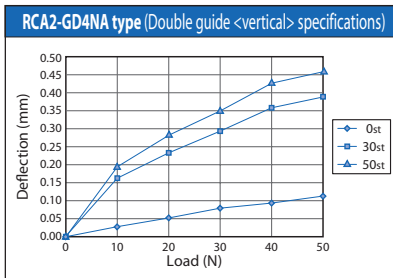
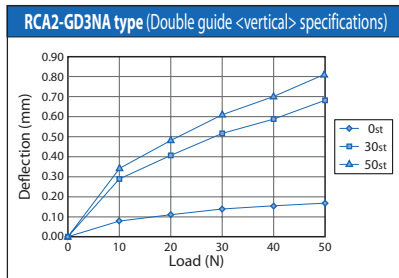
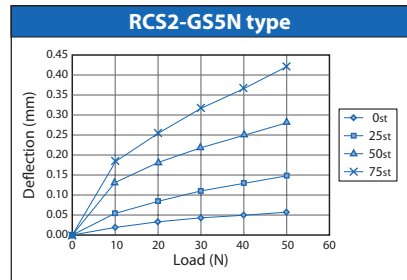
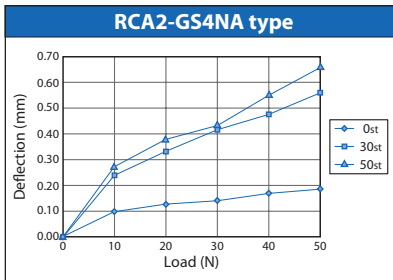
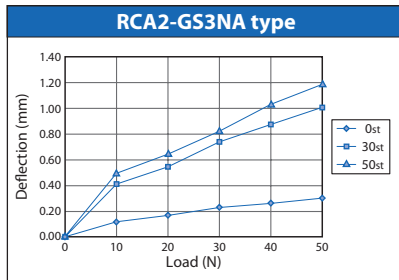

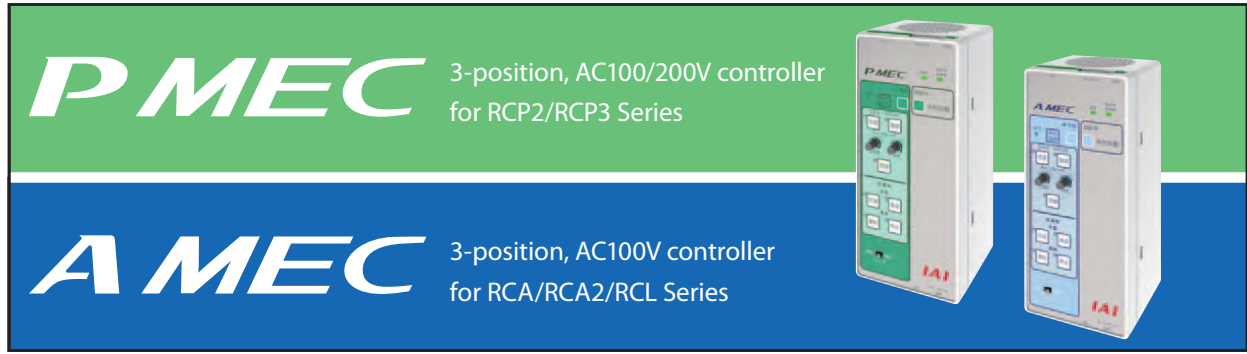

ROBO Cylinder 3-position controller **MEC** (Mechanical Engineer Control)

Feature

1 Low Cost

The MEC package, which combines a controller, power supply, acceleration/speed change function and PC connection cable, among others, is at an affordable price. The MEC PC software can be downloaded free of charge from IAI's website.



2 Easy Operation

Even a beginner can set up the controller without reading the operation manual. The acceleration and speed can be adjusted using the knobs on the controller.

* The setting range for acceleration/speed varies depending on the actuator. Please refer to the instruction manual for further detail.

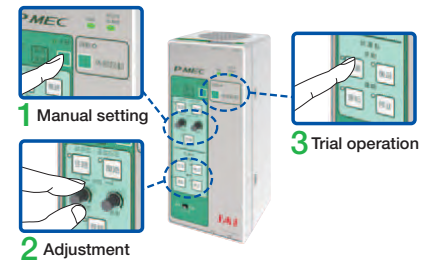

3 Easy Replacement from your Air-cylinder System

Operation signals are exactly the same as those used to operate air cylinders. This means that you can use the program of your current PLC directly.

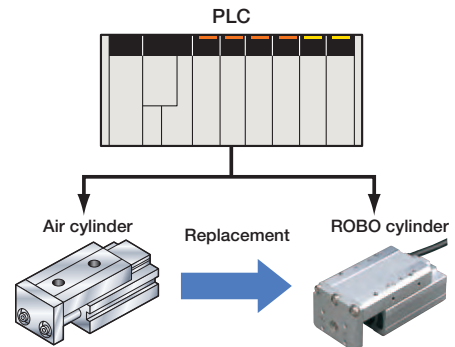



4 Push-motion Operation/Intermediate Stopping

Push-motion operation can be performed in the same manner as you would with any air-cylinder system.

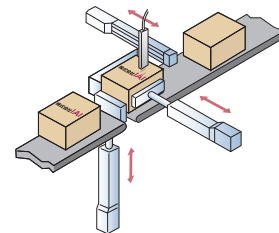
Also, you can cause the actuator to stop at any desired intermediate point between the home position and stroke end by changing the setting of the intermediate point using the MEC PC software.



Model List

Series	PMEC	AMEC
External View		
Applicable actuators	RCP2 / RCP3	
Power supply voltage	100V	100V-240V
Accessories	AC power supply cable (2m) USB cable (3m) I/O cable (2m) I/O connector EMG connector Standard mounting bracket	

- Mini Slider type
- Mini Rod type
- Mini Table type
- Mini Linear Servo type
- Controller

Model

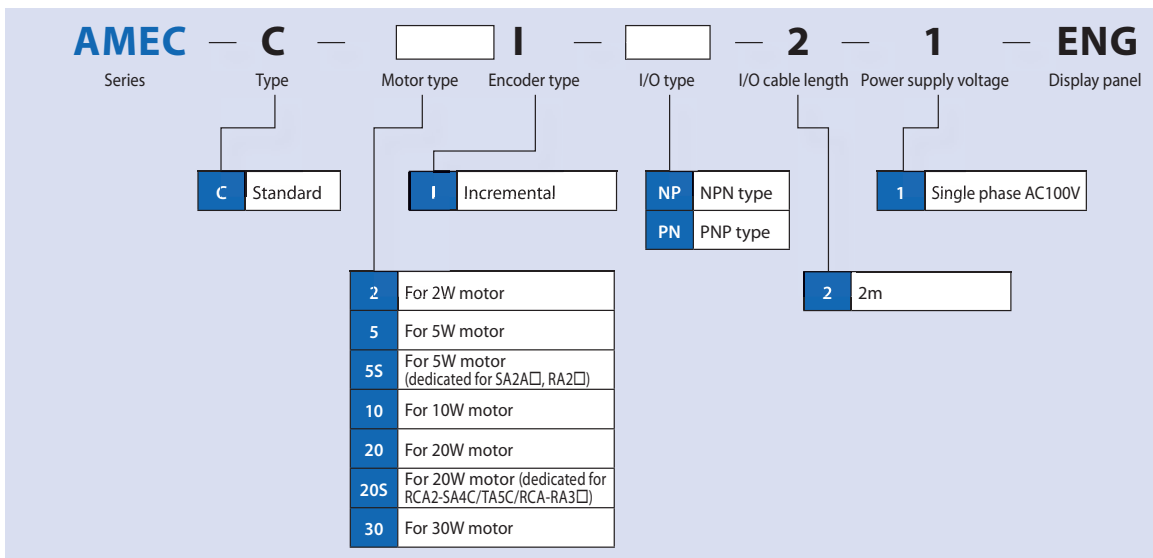
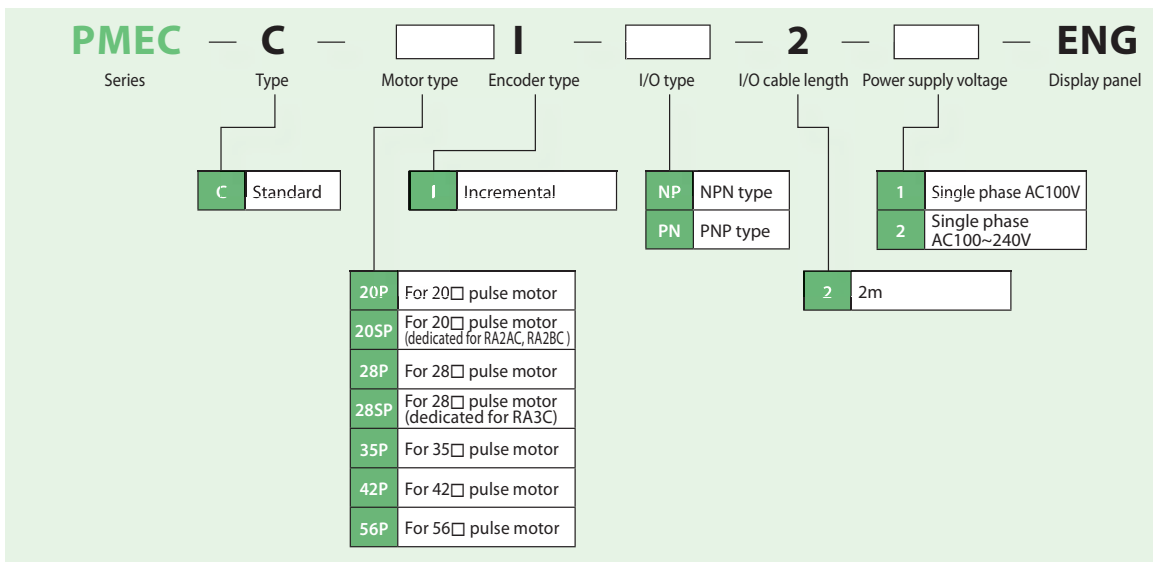

System Configuration

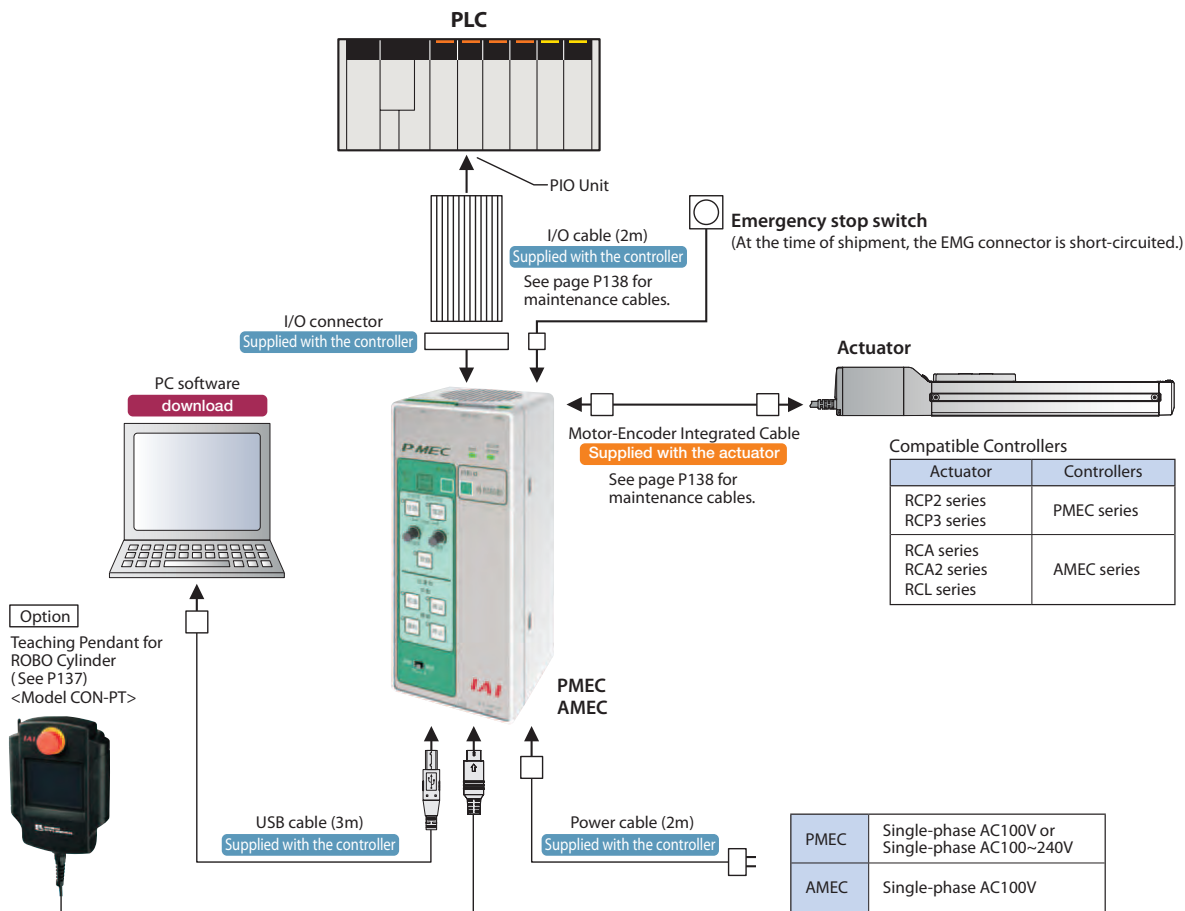

System Configuration

(Note) External power supply is needed.

Motion Pattern			2-Position Travel	3-Position Travel
Pin No.	Wire Color	Signal Type	Signal Name	Signal Name
1	Brown	PIO power	24V (Note)	24V (Note)
2	Red		0V (Note)	0V (Note)
3	Orange	Input	ST0 (Solenoid A: ON moves to end position, OFF moves to home position)	ST0 (Solenoid A: Move signal 1)
4	Yellow		—	ST1 (Solenoid B: Move signal 2)
5	Green		RES (Alarm reset)	RES (Alarm reset)
6	Blue		—	—
7	Purple	Output	LS0 (home position detection)/PE0 (home positioning complete)*1	LS0 (home position detection)/PE0 (home positioning complete)*1
8	Gray		LS1 (end position detection)/PE1 (end positioning complete)*1	LS1 (end position detection)/PE1 (end positioning complete)*1
9	White		HEND (Homing complete)	LS2 (intermediate point detection)/PE2 (intermediate positioning complete)*1
10	Black		*ALM (alarm)*2	*ALM (alarm)*2

*1: Signals PE0 through PE2 will be output if the pushing motion was enabled in the initial setting. Otherwise, LS0 through LS2 will be output.

*2: *ALM is ON when normal, and OFF when it is activated.

MEC PC software

By using the MEC PC software you can change the stop position data or run a test operation. In addition, you can change the setting on the intermediate stop function, pushing function or change the coordinates.

The MEC PC software can be downloaded from the IAI website.

IAI Website: www.intelligentactuator.com

Explanation of PIO Patterns

PIO Pattern (2-position travel)

This motion pattern is between two positions, the home position and the end position. The home and end positions can be configured numerically (using the MEC PC software or the optional touch panel teaching pendant). Two motions are possible: A positioning motion moves the rod or the slider to the specified position, and a pushing motion presses the rod against a workpiece.

Positioning

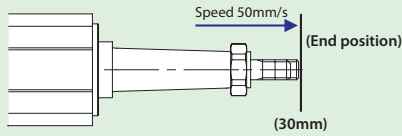

Input Signal

ST0	Solenoid A	ON
-----	------------	----

When ST0 is turned ON, the slider/rod moves at 50mm/s to the end position (30mm position).

End Position Data

Position	30mm
Speed	50mm/s
Pushing Force	—
Width	—

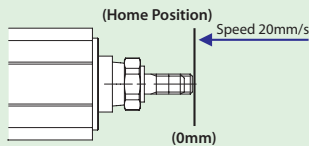

Input Signal

ST0	Solenoid A	OFF
-----	------------	-----

When ST0 is turned OFF, the slider/rod returns to the home position (0mm position) at 20mm/s.

Home Position Data

Position	0mm
Speed	20mm/s
Pushing Force	—
Width	—

PIO Pattern (2-position travel)

This motion pattern is between two positions, the home position and the end position, which enables a pushing motion of the rod against a workpiece.

Push

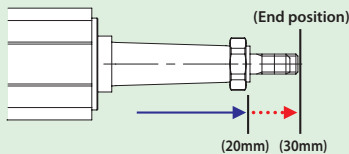

Input Signal

ST0	Solenoid A	ON
-----	------------	----

When ST0 is turned ON, the actuator moves the rod to the 20mm position at 80mm/s, and from there, pushes it at slower speed to the 30mm position.

End Position Data

Position	30mm
Speed	80mm/s
Pushing Force	50%
Width	10mm

* The pushing motion is performed when there is a numerical value in the controller's push force data. (If there is no numerical value, a positioning motion is performed instead.)

PIO Pattern (3-position travel)

This motion pattern enables moves between three positions: the end position and the home position, as well as an intermediate position.

The positions are switched by combining two signals, ST0 and ST1.

Positioning

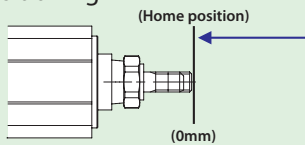

Input Signal

ST0	Solenoid A	ON
ST1	Solenoid B	OFF

When only ST0 is turned ON, the actuator moves to the starting position at a set acceleration and speed.

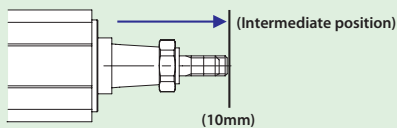

Input Signal

ST0	Solenoid A	ON*
ST1	Solenoid B	ON*

When both ST0 and ST1 are turned ON, it will move to the intermediate position at the set acceleration and speed. When both are turned OFF, it stops at the current position.

* You can also configure the initial settings so that the rod will move to the intermediate position with both signals turned OFF, and stop at the current position with both signals turned ON.

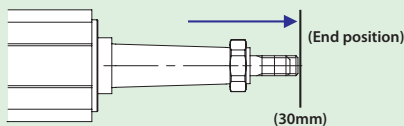

Input Signal

ST0	Solenoid A	OFF
ST1	Solenoid B	ON

When only ST1 is turned ON, the actuator moves to the end position at a set acceleration and speed.

Specifications Table

Item	Type		
Controller Type	PMEC		AMEC
Connectible Actuators	RCP2/RCP3 Series Actuators		RCA/RCA2/RCL Series Actuators
Number of Controllable Axes	Single axis		
Operation Method	Positioner Type		
Number of Positions	2 positions / 3 positions		
Backup Memory	EEPROM		
I/O Connector	10-pin terminal block		
I/O Points	4 input points / 4 output points		
Power for I/O	Externally supplied DC24V±10%		
Serial Communication	RS485: 1ch/USB: 1ch		
Position Detection Method	Incremental encoder		
Power Supply Voltage	AC100V-115V±10%	AC90V~264V	AC100V-115V±10%
Rated Current	1.3A	0.67A (AC100V)/0.36A (AC200V)	2.4A
Rush Current	30A	15A (AC100V)/30A (AC200V)	15A
Leak Current	0.50mA max	0.40mA max (AC100V) 0.75mA max (AC200V)	0.50mA max
Dielectric Strength Voltage	DC500V 1MΩ		
Vibration Resistance	XYZ directions 10~57Hz One-side amplitude 0.035mm (continuous), 0.075mm (intermittent) 57~150Hz 4.9m/s ² (continuous), 9.8m/s ² (intermittent)		
Ambient Operating Temperature	0~40°C		
Ambient Operating Humidity	10~85% RH (non-condensing)		
Ambient Operating Atmosphere	Free from corrosive gases		
Protection Class	IP20		
Weight	500g	508g	614g

Note: The minimum/maximum speeds vary depending on the actuator model. For more information, see the instruction manual, or contact IAI.

Outer Dimensions

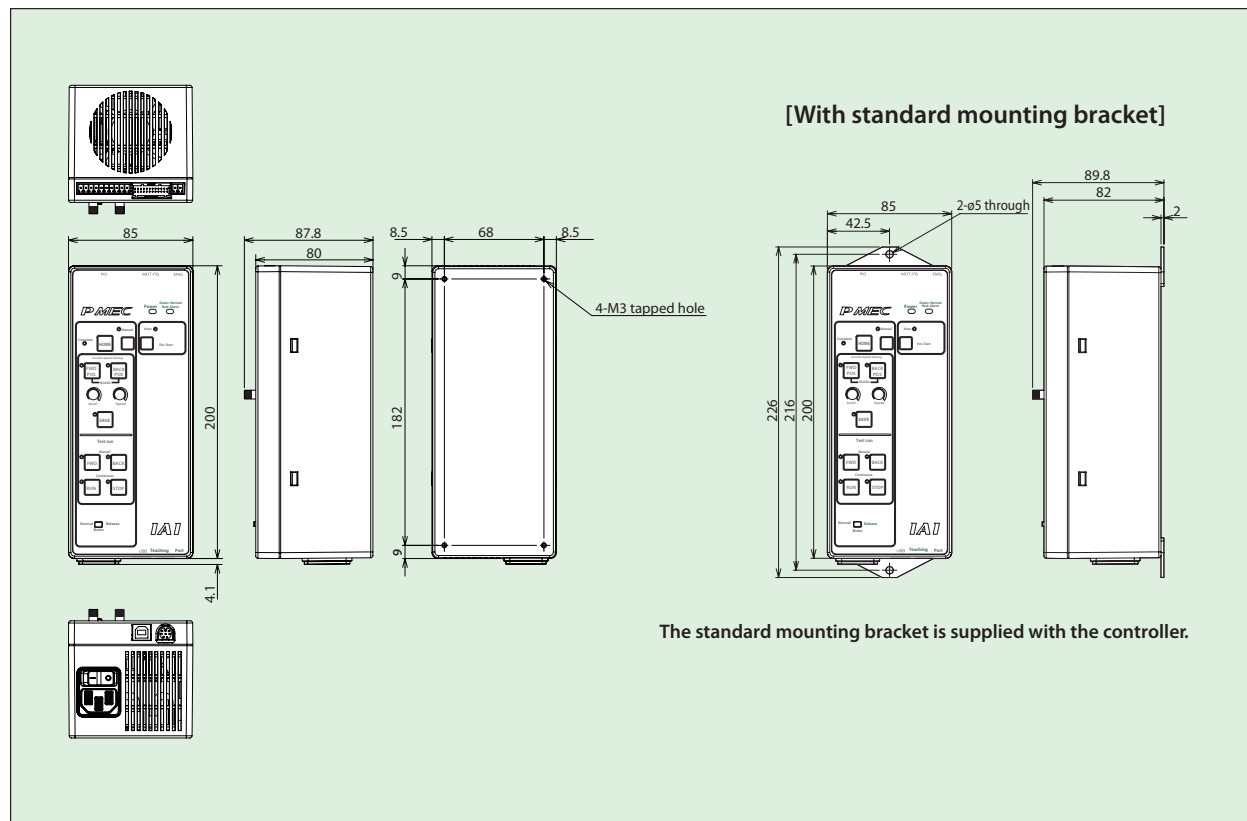

135 PMEC / AMEC

Sold & Serviced By: **ELECTROMATE**

Toll Free Phone (877) SERV098
Toll Free Fax (877) SERV099
www.electromate.com
sales@electromate.com

Names of Parts and Functions

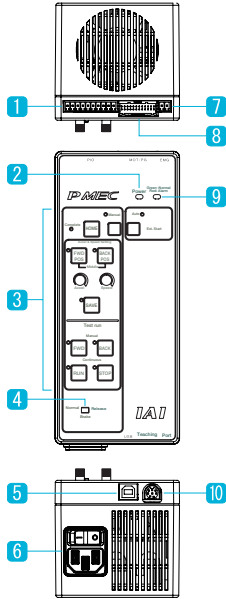

- 1 PIO connector** Connects with a PLC or other external controllers to communicate inputs and outputs (I/O).
- 2 Power LED** When the power is ON, it illuminates in green.
- 3 Control panel** See below
- 4 Brake switch**

Release	Used to release the brake of the actuator
Normal	The controller automatically controls the brake of the actuator
- 5 USB connector** When using MEC PC software, connect to the computer via USB.
- 6 AC inlet** Insert the power supply cable.
- 7 EMG connector** Connect the emergency stop button. Short-circuit it if you will not be using an emergency stop button.
- 8 M/PG connector** Insert the motor/encoder cable that connects with the actuator.
- 9 Status LED**

RUN (Green)	Indicates the servo status. On = Servo ON, Off=Servo OFF (Energy-saving) status Flashing (1Hz)=Auto servo OFF
ALM (Red) EMG (Red)	The LED illuminates if an alarm is turned ON or if the controller has come to an emergency stop.
- 10 SIO Connector** Connects with the teaching pendant (CON-PT, SEP-PT).



Explanation of the Control Panel

HOME button

When starting, homing is performed first to confirm the 0mm coordinate.

Manual button

Press this button to set the acceleration and/or speed, or to run a test operation. (Press for at least 1 second)

AUTO button

Press this button when operating from the MEC PC software or the PLC commands. (Press for at least 1 second)

Acceleration/Speed Settings
Configure the actuator's motion.

FWD POS / BACK POS button

Switch the motion you want to configure (see types below).

FWD POS: Motion toward the end position
BACK POS: Motion toward the home position
Middle: Motion toward an intermediate position (Enabled from the MEC PC software and switched on by simultaneously pressing "FWD POS" and "BACK POS" buttons to switch. During a 2-position stop, simultaneous pressing is disabled.)

Acceleration / Speed knob

By turning the knob, you can change the speed between 1%~100% of the actuator's maximum speed or rated acceleration / deceleration.

* The minimum speed may be less than 1% in some cases.

SAVE button

Saves the speed and acceleration adjusted above.

Test Operation
Confirm the saved motion by physically running the actuator.

FWD button

In a 2-position travel, the actuator moves from the BACK position to the FWD position. In a 3-position travel, the actuator moves from the BACK position to the intermediate position, then to the FWD position.

BACK button

The actuator returns to the home position.

RUN button

In a 2-position travel, the actuator moves back and forth between the FWD and BACK positions. In a 3-position travel, the actuator repeats its movement from the BACK position, intermediate position, FWD position, then BACK position.

STOP button

Stops the above operation.

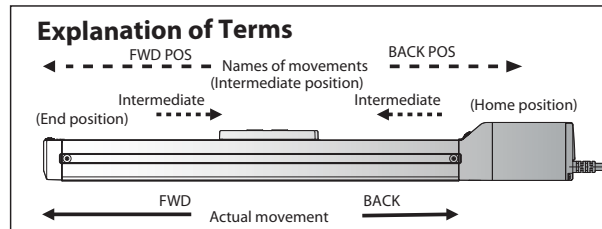

Option

CON-PTA Touch-panel Teaching Pendant for Position Controller

Developed based on the design of the popular CON-PT series adopting an easy-to-use interactive touch-panel menu screen, this new data input device supports various functions offered by the PCON-CA controller.



CON-PTA

1. Color screen for greater ease of view
2. Supporting the takt time minimization function and maintenance information checking/ input functions of the PCON-CA
3. Position, parameters and other data can be saved in a SD card
4. Built-in clock function records the date & time of each event; data can then be saved in a SD card.

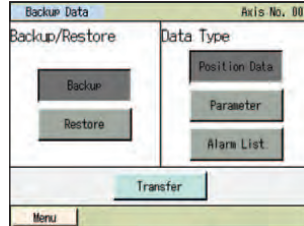
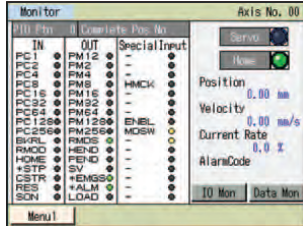

Model Numbers/Specifications

Item	Description		
	CON-PTA-C-ENG	CON-PDA-C-ENG	CON-PGA-C-S-ENG
Model number	CON-PTA-C-ENG	CON-PDA-C-ENG	CON-PGA-C-S-ENG
Type	Standard type	Enable switch type	Safety-category compliant type
Connectable controllers	ACON/PCON/SCON/RACON/RPCON ASEP/PSEP AMEC/PMEC ERC2 (*1)/ERC3		
3-position enable switch	×	○	○
Functions	<ul style="list-style-type: none"> • Position data input/editing • Moving function (moving to set positions, jogging/inching) • Parameter editing • Monitoring (current position, current speed, I/O signals, alarm code, alarm generation time) • Saving/reading data to/from external SD cards (position data parameters, alarm list) • Takt time minimization function • Maintenance information (total number of movements, total distance travelled, etc.) 		
Display	65536 colors (16-bit colors), white LED backlight		
Ambient operating temperature/humidity	0 to 40°C, 85% RH or less (Non-condensing)		
Environmental resistance	IP40 or equivalent		
Mass	Approx. 570g		Approx. 600g
Cable length	5m		
Accessories	Stylus	Stylus	Stylus, TP adapter (Model number: RCB-LB-TG) Dummy plug (Model number: DP-4) Controller cable (Model number: CB-CON-LB005)

*1 Among the ERC2 series, only the actuators bearing 4904 or greater number stamped on the serial number label can be connected.

Name of Each Part

■ Name of Each Part/External Dimensions

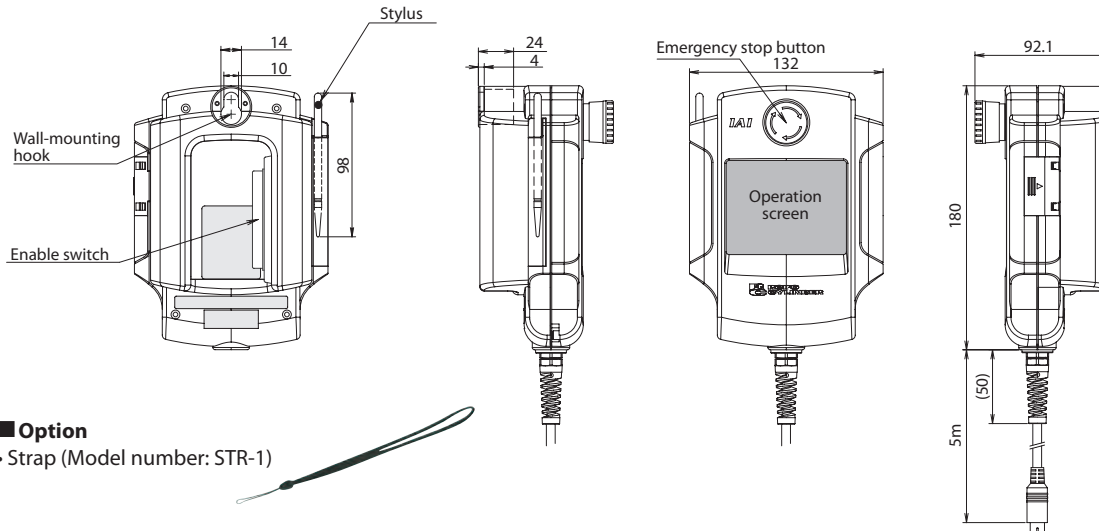

■ Option

- Strap (Model number: STR-1)

137

PMEC / AMEC

● DIN Rail Mounting Bracket MEC-AT-D

■ Dimensions

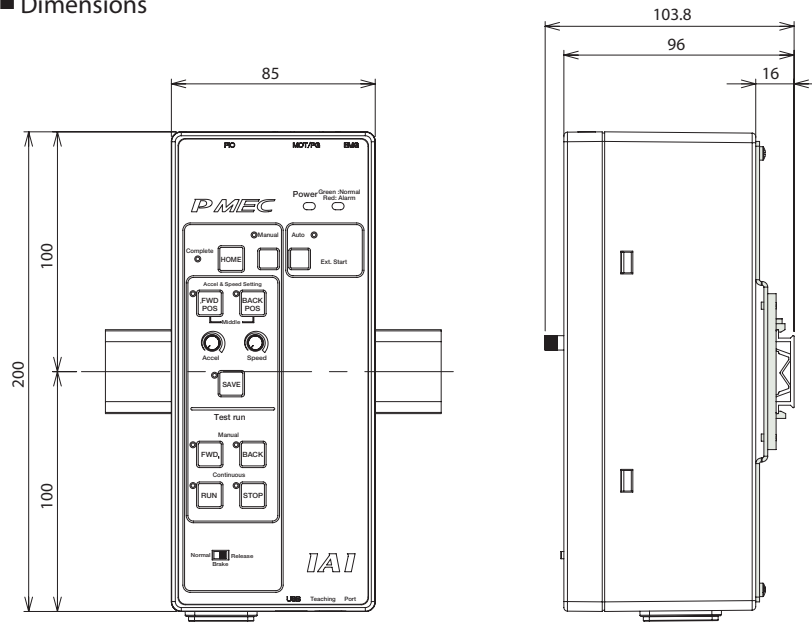

● Maintenance cable

■ List of maintenance cable models

Type	Cable length	Cable length	Model	Standard price
Integrated motor-encoder cable	PMEC ←→ RCP3 RCP2-GRSS/GRLS/ GRST/ SRA4R/SRGS4R/ SRGD4R	1m	CB-APSEP-MPA010	—
		3m	CB-APSEP-MPA030	—
		5m	CB-APSEP-MPA050	—
	AMEC ←→ RCA2/RCL	1m	CB-PSEP-MPA010	—
		3m	CB-PSEP-MPA030	—
		5m	CB-PSEP-MPA050	—
	PMEC ←→ RCP2	1m	CB-RPSEP-MPA010	—
		3m	CB-RPSEP-MPA030	—
		5m	CB-RPSEP-MPA050	—
	PMEC ←→ RCP2-RTBS/RTBSL -RTCS/RTCSL	1m	CB-ASEP-MPA010	—
		3m	CB-ASEP-MPA030	—
		5m	CB-ASEP-MPA050	—
	AMEC ←→ RCA	2m	CB-APMEC-PIO020-NC	—
		3m	CB-APMEC-PIO030-NC	—
		5m	CB-APMEC-PIO050-NC	—
I/O cable	3m	CB-SEL-USB030	—	
USB cable	3m			

Components for maintenance

Please refer to the models listed below when arrangements such as cable replacement are needed after purchasing the product.

[RCP3/RCP2 (for specific models*) /RCA2/RCL]-[PMEC/AMEC] Motor encoder integrated cable for indirect connection

Model **CB-APSEP-MPA**

* indicated the cable length (L)
Lengths up to 20m can be specified Example) 080=8m

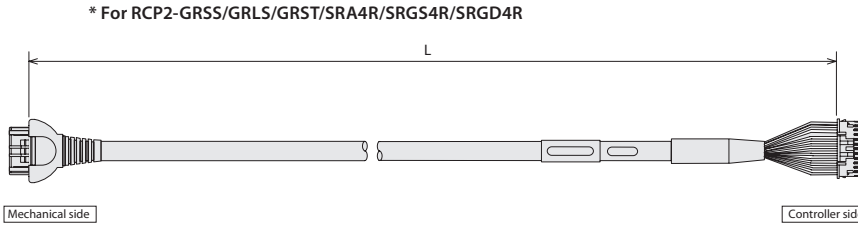

Mechanical side Pin number	[PCON](ACON)	Controller side Pin number
A1	Black [ØA](U)	1
B1	White [VMM](V)	2
A2	Brown [ØA](W)	5
B2	Green [ØB](-)	3
A3	Yellow [VMM](-)	4
B3	Red [ØB](-)	6
A4	Orange [LS+](BK+)	7
B4	Gray [LS-](BK-)	8
A6	White [-](A+)	11
B6	Yellow [-](A-)	12
A7	Red [A+](B+)	13
B7	Green [A-](B-)	14
A8	Black [B+](Z+)	15
B8	Brown [B-](Z-)	16
A5	Black (label)[BK+](LS+)	9
B5	Brown (label)[BK-](LS-)	10
A9	Green (label)GNDLS	20
B9	Red (label)VPS	18
A10	White (label)VCC	17
B10	Yellow (label)GND	19
A11	NC	21
B11	Shield FG	24
	NC	22
	NC	23

Minimum bend radius $r = 68\text{mm}$ or larger (when movable unit is used)

[RCP2]-[PMEC] Integrated motor-encoder connection cable

Model **CB-PSEP-MPA**

* indicated the cable length (L)
Lengths up to 20m can be specified Example) 080=8m

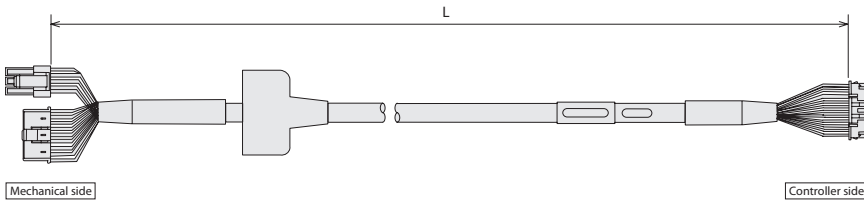

Mechanical side Pin number	Controller side Pin number	
1	Black [ØA]	1
2	White [VMM]	2
4	Red [ØB]	3
5	Green [VMM]	4
3	Brown [ØA]	5
6	Yellow [ØB]	6
16	Orange [BK+]	9
17	Gray [BK-]	10
5	NC	11
6	NC	12
13	Black [LS+]	7
14	Brown [LS-]	8
1	White [A+]	13
2	Yellow [A-]	14
3	Red [B+]	15
4	Green [B-]	16
10	White (label)[VCC]	17
11	Yellow (label)[VPS]	18
9	Red (label)[GND]	19
12	Green (label)[Spare]	20
15	NC	21
7	NC	22
8	NC	23
18	Shield [FG]	24

Minimum bend radius $r = 68\text{mm}$ or larger (when movable unit is used)

[RCA]-[AMEC] Integrated motor-encoder connection cable

Model **CB-ASEP-MPA**

* indicated the cable length (L)
Lengths up to 20m can be specified Example) 080=8m

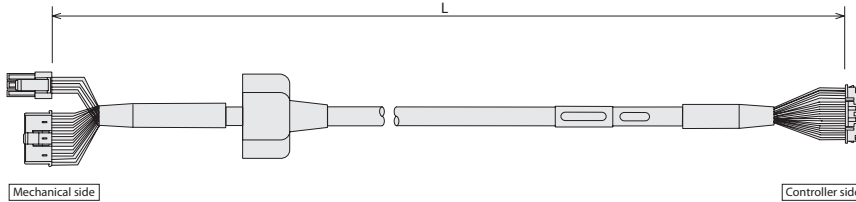

Mechanical side Pin number	Controller side Pin number	
1	Red [U]	1
2	Yellow [V]	2
—	NC	3
—	NC	4
3	Black [W]	5
—	NC	6
18	Orange [BK+]	7
17	Gray [BK-]	8
7	Black [LS+]	9
16	Brown [LS-]	10
1	White [A+]	11
2	Yellow [A-]	12
3	Red [B+]	13
4	Green [B-]	14
10	Black (label)[Z+]	15
11	Brown (label)[Z-]	16
14	White (label)[VCC]	17
13	Yellow (label)[VPS]	18
15	Red (label)[GND]	19
6	Green (label)[Spare]	20
5	NC	21
8	NC	22
12	NC	23
9	Shield [FG]	24

Minimum bend radius $r = 68\text{mm}$ or larger (when movable unit is used)

[RCP2 small rotary]-[PMEC] Motor encoder integrated cable for indirect connection

Model **CB-RPSEP-MPA**

* indicated the cable length (L)
Lengths up to 20m can be specified Example) 080=8m

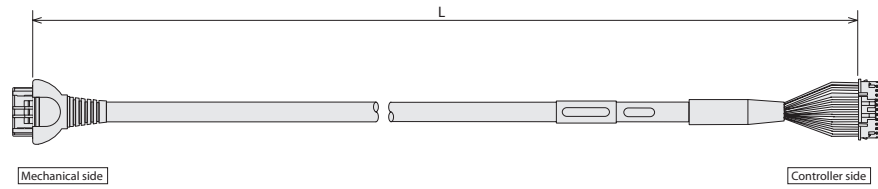

Minimum bend radius $r = 68\text{mm}$ or larger (when movable unit is used)

Mechanical side Pin number		Controller side Pin number
A1	Black [ØA]	1
B1	White [VMM]	2
A2	Brown [Ø/A]	5
B2	Green [ØB]	3
A3	Yellow [VMM]	4
B3	Red [Ø/B]	6
A6	Orange [LS+]	7
B6	Gray [LS-]	8
A7	Red [A+]	13
B7	Green [A-]	14
A8	Black [B+]	15
B8	Brown [B-]	16
A4	NC	7
B4	NC	8
A5	Black (label)[BK+]	9
B5	Brown (label)[BK-]	10
A9	Green (label)[GNDLS]	20
B9	Red (label)[VPS]	18
A10	White (label)[VCC]	17
B10	Yellow (label)[GND]	19
A11	NC	21
B11	Shield FG	24
	NC	22
	NC	23

- Mini Slider type
- Mini Rod type
- Mini Table type
- Mini Linear Servo type
- Controller

I/O cable for PMEC-C/AMEC-C

Model **CB-APMEC-PIO** -NC

* The 3 types differ in cable length: 020=2m, 030=3m, 050=5m

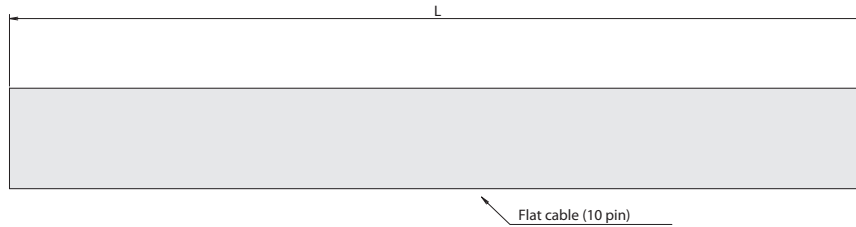

Pin NO.	Electric wire color	Signal
1	Brown	PIO Power supply
2	Red	
3	Orange	
4	Yellow	Input
5	Green	
6	Blue	
7	Purple	Output
8	Gray	
9	White	
10	Black	

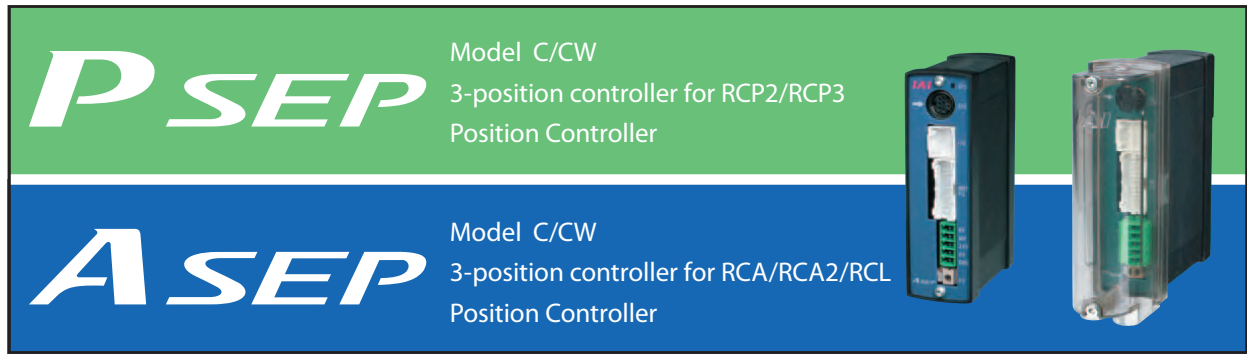

Feature

1 Can operate with the same signal as a solenoid valve.

The signal that operates the actuator is the same as the signal that operates the air cylinder. Therefore, the PLC program currently in use can be used without modification even if the air cylinder is replaced by an electric-powered cylinder. Either a single solenoid or a double solenoid may be used.

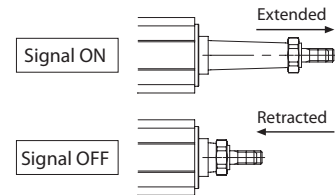

2 Establishes a dustproof type that supports IP53.

We provide dustproof type controllers with an IP53 equivalent (*1) protection structure, so that the controller can be mounted outside the control panel. (*1) The bottom surface is excluded.



3 Provides the simple absolute type that can be operated immediately upon power-ON without homing.

Since the simple absolute type can store the current position with the assistance of the absolute battery unit during power-up or after the emergency stop is deactivated; it can start the next operation at that position.

(Note 1) When the actuator is connected to the simple absolute type controller, the model is considered an incremental model.

When mounting the absolute battery unit, mount it below the SEP controller to prevent heat damage.

(Note 2) It can not be used for the linear servo type.

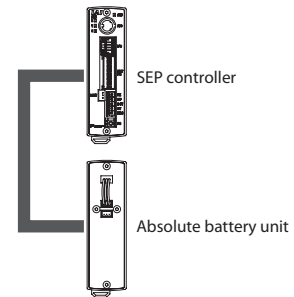

4 Pushing and intermediate stop operation is available.

Like air cylinders, the pushing operation is available. In this operation, you can stop with a rod being pushed to a workpiece. Since the force for the push operation is adjustable within a range between 20 to 70 % of the maximum pushing force and a signal is generated when it reaches the specified pushing force, it can be used to perform such tasks as clamping the workpiece or determine its size.

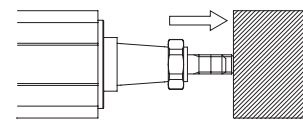





Push force can be adjusted from 20 to 70% of the maximum push force.

5 Easy data entry with the dedicated touch panel teaching unit.

Data, such as setting target positions or pushing force, are easily entered with the optional touch panel teaching unit model: CON-PTA. Since the touch panel teaching unit provides an interactive menu and can be controlled directly on the screen, you can operate intuitively with no assistance from operation manuals.



Model List

Series	PSEP				ASEP			
	C		CW		C		CW	
Type	Standard type		Dustproof type		Standard type		Dustproof type	
Name	Incremental encoder	Simple absolute type	Incremental encoder	Simple absolute type	Incremental encoder	Simple absolute type	Incremental encoder	Simple absolute type
Positioning method								
External View								
Description	Position controller, for pulse motors, specialized to 2 positions / 3 positions positioning and easier control		PSEP-C dustproof type with an IP53 equivalent protection structure		Position controller, for pulse motors, specialized to 2 positions / 3 positions positioning and easier control		ASEP-C dustproof type with an IP53 equivalent protection structure	
Number of positions	2 positions / 3 positions							
Standard price	—	—	—	—	—	—	—	—

Model

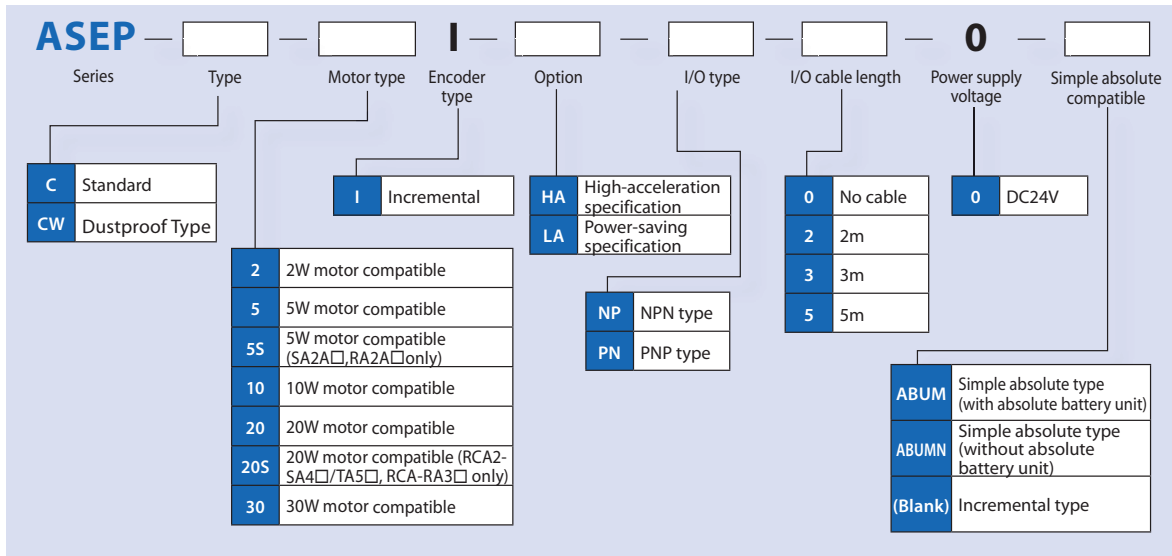
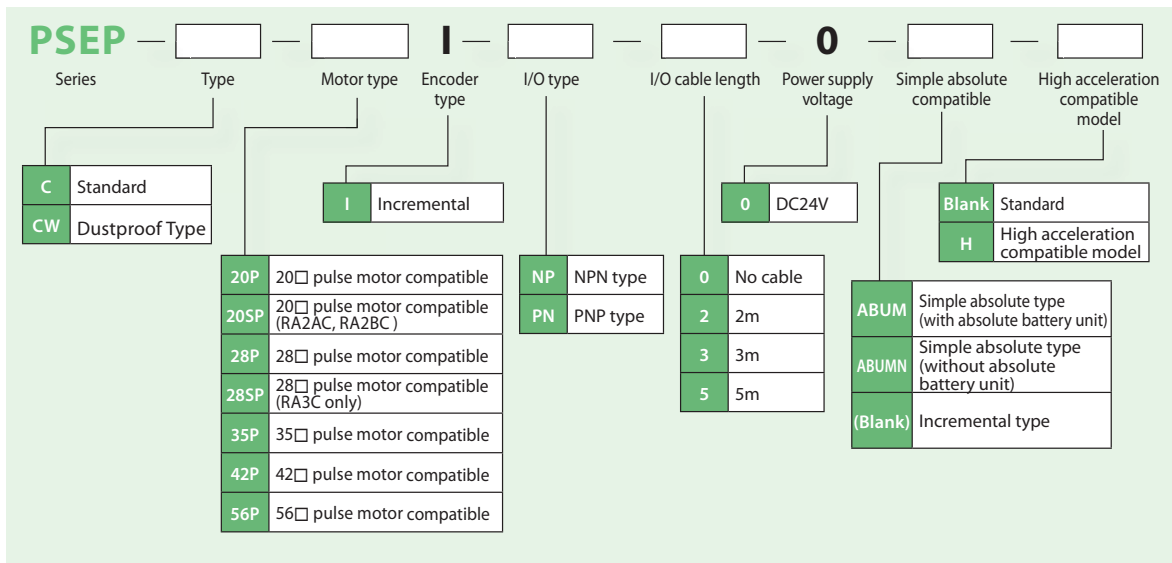

System configuration

<PSEP>

PC software
Refer to P. 153.
RS232 connection version
<Model number:
RCM-101-MW>
USB connection version
<Model number:
RCM-101-USB>
*The cable comes with
the PC software.
*Versions older than
7.00.01.00 cannot be
used with SEP controllers.

Teaching Pendant for
□CON/R□CON/□SEP
Refer to P. 151.
<Model number:
CON-PTA/CON-PDA/CON-PGA>
Teaching Pendant for SEP
<Model number: SEP-PT>

PLC

Field network
DeviceNet/CC-Link/Profibus

PIO cable
<Model CB-APSEP-PIO020> (standard)
<Model CB-APSEPW-PIO020> (for dustproof)
Standard 2m
(Supplied with the controller)
Refer to P. 156.

DC24V power supply
<Model PS-241 (100V input)>
<Model PS-242 (200V input)>



5m

Standard 0.5m

Absolute battery unit for SEP controller
(Supplied with simple absolute type)
<Model SEP-ABU> (standard)
<Model SEP-ABU-W> (for dustproof)
Refer to P. 154

Moter-encoder integrated cable
<Model CB-PSEP-MPA□□□>
Standard 1m / 3m / 5m
(Supplied with the actuator)
Refer to P. 155.



Actuator, RCP2 Series
Rotary type RCP2-RT
(See below for small rotary)
Gripper type RCP2-GRS/GRM/GR3□□

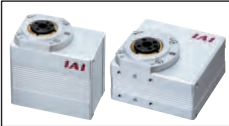

RCP2 small rotary
(RCP2-RTBS/RTBSL/RTCS/RTCSL)
*The above models use a dedicated cable.

Moter-encoder integrated cable
<Model CB-RPSEP-MPA□□□>
Standard 1m / 3m / 5m
(Supplied with the actuator)
Refer to P. 156.

Moter-encoder integrated cable
<Model CB-APSEP-MPA□□□>
Standard 1m / 3m / 5m
(Supplied with the actuator)
Refer to P. 155.

<PCON/RPCON/PSEL>



Moter-encoder integrated cable
<Model CB-PCS-MPA□□□>
Standard 1m / 3m / 5m
(Supplied with the actuator)
Refer to P. 155.



Actuator, RCP3 Series
RCP2-GRSS/GRLS/GRST
RCP2-SRA4R/SRGS4R/SRGD4R

System configuration

<ASEP>

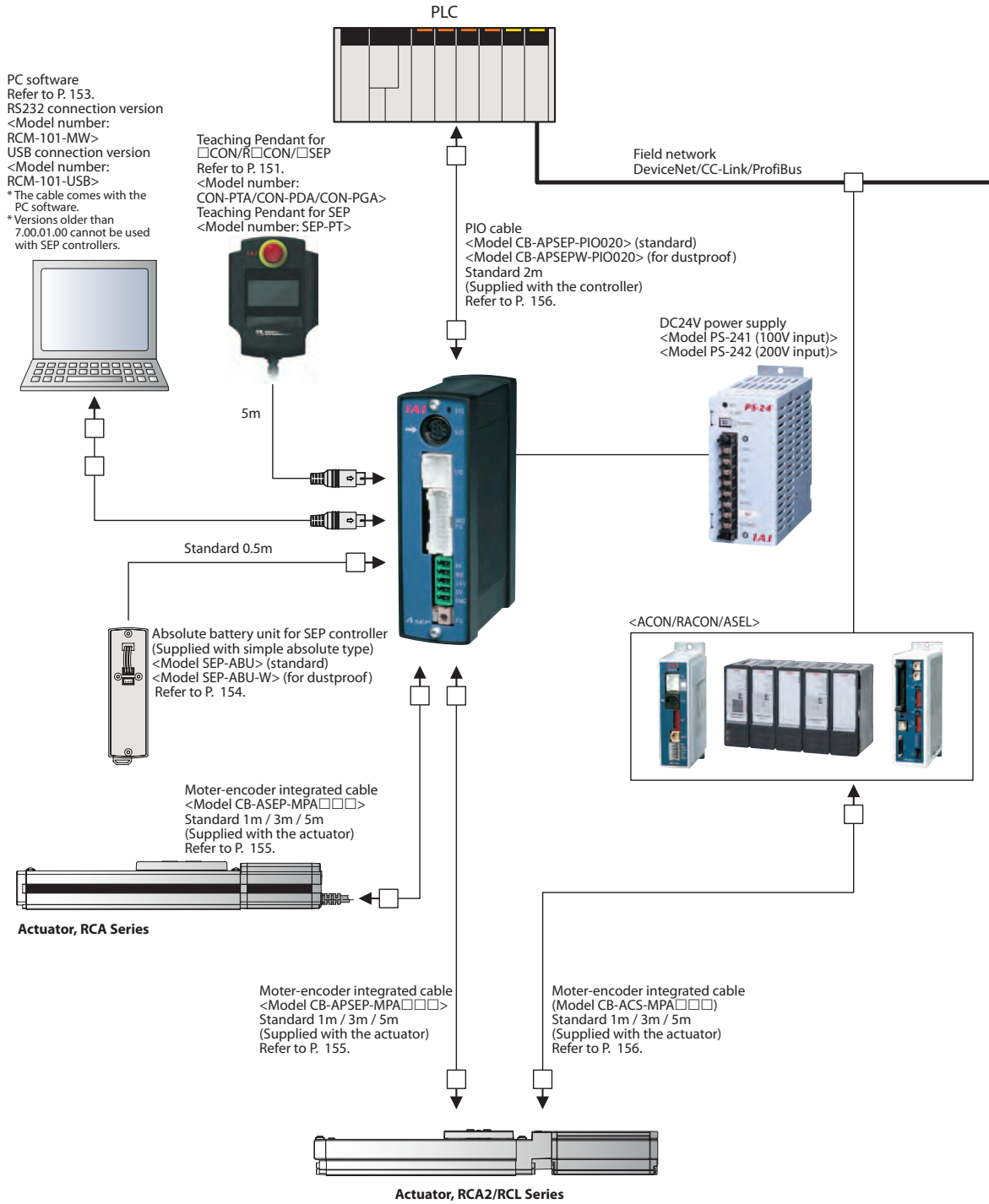

Mini Slider type
Mini Rod type
Mini Table type
Mini Linear Servo type
Controller

PIO Pattern Description

The SEP controller provides the following six PIO patterns from which you can choose for operation. Also, PIO patterns 0 to 2 support both the single solenoid and double solenoid signal configurations.

PIO pattern number		0		1		2		3		4		5		
PIO pattern name		Standard 2-position movement		Moving speed change		Position data change		2-input 3-position travel		3-input 3-position travel		Continuous cycle operation		
Feature		2-position motion		2-position motion		2-position motion		3-position motion		3-position motion		Continuous motion between 2 positions		
		Push		Push		Push		Push		Push		Push		
		—		Changing speed during motion		Motion position data change		—		—		—		
Supported solenoid configurations		Single	Double	Single	Double	Single	Double	—		—		—		
Input		0	Motion signal	Motion signal 1	Motion signal	Motion signal 1	Motion signal	Motion signal 1	Motion signal 1	Retract motion signal	Continuous operation signal			
		1	Pause signal	Motion signal 2	Pause signal	Motion signal 2	Pause signal	Motion signal 2	Motion signal 2	Extend motion signal	Pause signal			
		2	— (Reset signal)	—	Moving speed change signal (Reset signal)	—	Target position change signal (Reset signal)	—	— (Reset signal)	—	Intermediate motion signal (Reset signal)	— (Reset signal)		
		3	— /Servo-ON signal	—	—	—	—	—	— /Servo-ON signal	—	—	— /Servo-ON signal		
Output		0	Retract motion output signal	Retract motion output signal	Retract motion output signal	Retract motion output signal	Retract motion output signal	Retract motion output signal	Retract motion output signal	Retract motion output signal	Retract motion output signal			
		1	Extend motion output signal	Extend motion output signal	Extend motion output signal	Extend motion output signal	Extend motion output signal	Extend motion output signal	Extend motion output signal	Extend motion output signal	Extend motion output signal			
		2	Homing completion signal /Servo-ON output signal	Homing completion signal /Servo-ON output signal	Homing completion signal /Servo-ON output signal	Homing completion signal /Servo-ON output signal	Homing completion signal /Servo-ON output signal	Homing completion signal /Servo-ON output signal	Midpoint position output signal	Midpoint position output signal	Midpoint position output signal	Homing completion signal /Servo-ON output signal		
		3	Alarm output signal /Servo-ON output signal	Alarm output signal /Servo-ON output signal	Alarm output signal /Servo-ON output signal	Alarm output signal /Servo-ON output signal	Alarm output signal /Servo-ON output signal	Alarm output signal /Servo-ON output signal	Alarm output signal /Servo-ON output signal	Alarm output signal /Servo-ON output signal	Alarm output signal /Servo-ON output signal	Alarm output signal /Servo-ON output signal		

*For details of the signals listed above, see the Controller User's Manual. (Can be downloaded from our corporate website.)

PIO pattern 0 (Standard 2-position travel)

This PIO pattern involves movements between two positions—the end position and the home position. The positions can be set numerically to any position (by inputting to the controller using the PC software or the optional touch panel teaching pendant). Two motions are possible: A "positioning motion" moves the rod or the slider to the specified position, and a "pushing motion" pushes the rod against a workpiece.

Positioning motion (single solenoid)

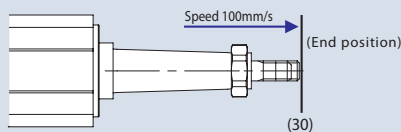

End position data	
Position	30
Speed	100
Push force	—
Width	—

Input signal

Input	Signal
Input 0	ON
Input 1	—
Input 2	—
Input 3	—

When Input 0 is turned ON, the slider/rod moves to the end position (30mm coordinate) at a speed of 100mm/s.

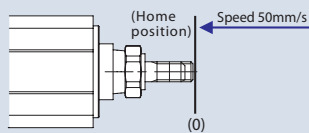

Home position data	
Position	0
Speed	50
Push force	—
Width	—

Input signal

Input	Signal
Input 0	OFF
Input 1	—
Input 2	—
Input 3	—

When input 0 is turned OFF, the slider/rod returns to the home position (0mm coordinate) at a speed of 50mm/s.

Positioning motion (double solenoid)

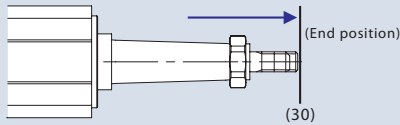

End position data	
Position	30
Speed	100
Push force	—
Width	—

Input signal

Input 0	OFF
Input 1	ON
Input 2	—
Input 3	—

When Input 1 is turned ON and Input 0 is turned OFF, the slider/rod moves to the end position (30mm coordinate) at a speed of 100mm/s.

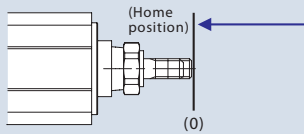

Home position data	
Position	0
Speed	50
Push force	—
Width	—

Input signal

Input 0	ON
Input 1	OFF
Input 2	—
Input 3	—

When Input 0 is turned ON and Input 1 is turned OFF, the slider/rod returns to the home position (0mm coordinate) at a speed of 50mm/s.

Push motion (single solenoid)

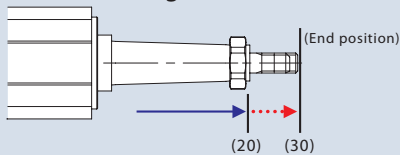

End position data	
Position	30
Speed	100
Push force	50
Width	10

Input signal

Input 0	ON
Input 1	—
Input 2	—
Input 3	—

When Input 0 is turned ON, the rod moves to the 20mm position at 100mm/s, and then starts pushing from the 20mm position to the 30mm position at slow speed.

* The pushing motion is performed only if there is a numerical value for the pushing force in the controller's position data. (If there is no numerical value for the pushing force, a positioning motion will be performed instead.)

Push motion (double solenoid)

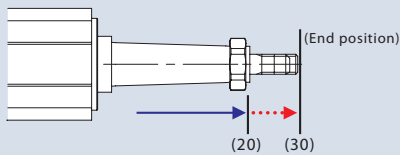

End position data	
Position	30
Speed	100
Push force	50
Width	10

Input signal

Input 0	OFF
Input 1	ON
Input 2	—
Input 3	—

When Input 1 is turned ON and Input 0 is turned OFF, the rod moves to the 20mm position at 100mm/s, and then starts pushing from the 20mm position to the 30mm position at slow speed.

* The pushing motion is performed only if there is a numerical value for the pushing force in the controller's position data. (If there is no numerical value for the pushing force, a positioning motion will be performed instead.)

PIO pattern 1 (Speed Change during movement)

This PIO pattern involves movements between two positions—the end position and the home position. The speed can be changed in 2 stages. (The speed can be either increased or decreased.) The speed change occurs when the rod/slider passes the speed change position, specified in the position values.

(Single solenoid)

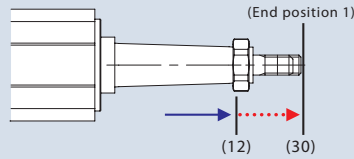
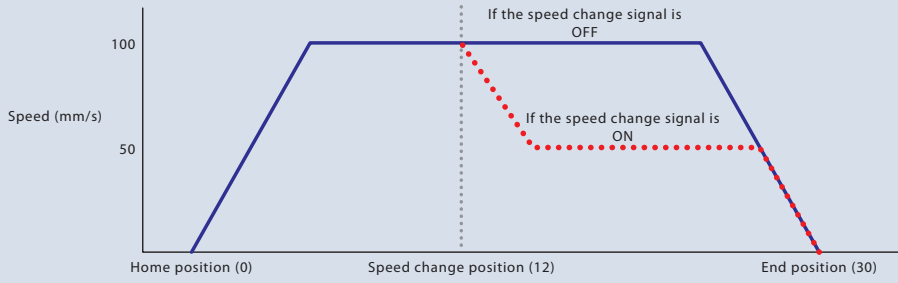

Input signal

Input 0	ON
Input 1	—
Input 2	ON
Input 3	—

When Input 0 is turned ON while Input 2 is turned ON, the rod moves at the initial speed up to the speed change position. After it passes the speed change position, the speed changes. If Input 2 is not turned ON, the speed will not change.

Home position data	
Position	0
Speed	50
Speed change position	12
Changed speed	100
Push force	—
Width	—

End position data	
Position	30
Speed	100
Speed change position	12
Changed speed	50
Push force	—
Width	—

PIO pattern 2 (position change)

This PIO pattern involves movements between two positions—the end position and the home position. You can set 2 sets of data for the end / home positions, speed, pushing force, and pushing width. Switching between the 2 sets of data can be done by turning ON/OFF Input 2, which is the signal for switching the target position.

(Single solenoid)

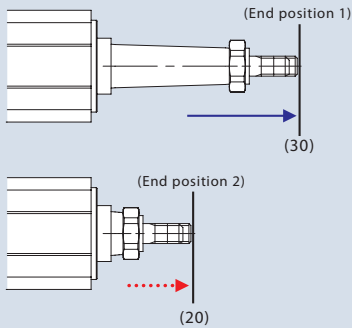
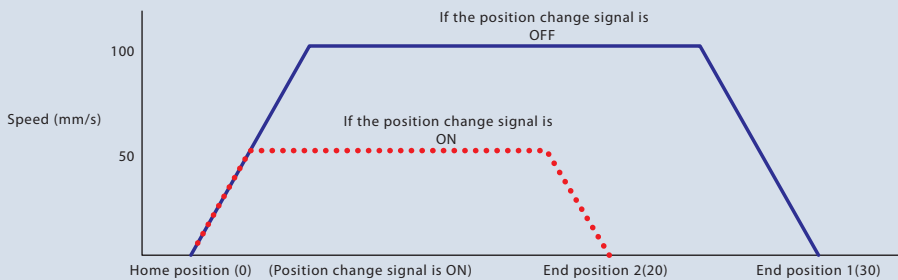

Input signal

Input 0	ON
Input 1	—
Input 2	ON
Input 3	—

If Input 2 (position change signal) is OFF when Input 0 is turned ON, the rod moves according to the position and speed set in "End Position Data 1" (position: 30 / speed: 100). If Input 2 is ON when Input 0 is turned ON, the rod's movement changes to the position and speed set in "End Position Data 2" (position: 20 / speed: 50). If Input 2 is OFF when the movement starts, but is turned ON in transit, the target position and speed is changed from that position.

End position data 1	
Position	30
Speed	100
Push force	—
Width	—

End position data 2	
Position	20
Speed	50
Push force	—
Width	—

PIO pattern 3 (2-input 3-position travel)

This PIO pattern involves movements between 3 positions—the end position, the home position, and an intermediate position. Changing between the positions is done by a combination of 2 signals, Input 0 and Input 1.

Positioning motion

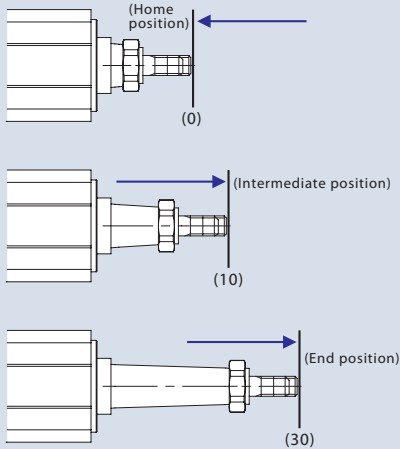

Input signal

Input 0	ON
Input 1	OFF
Input 2	—
Input 3	—

When only Input 0 is turned ON, the rod moves to the home position at the specified speed.

Input signal

Input 0	ON
Input 1	ON
Input 2	—
Input 3	—

When Input 0 and Input 1 are both turned ON, the rod moves to the intermediate position at the specified speed.

Input signal

Input 0	OFF
Input 1	ON
Input 2	—
Input 3	—

When only Input 1 is turned ON, the rod moves to the end position at the specified speed.

PIO pattern 4 (3-input 3-position travel)

This PIO pattern involves movements between 3 positions—the end position, the home position, and an intermediate position. Changing between positions is done by three signals—Input 0, Input 1 and Input 2, which are commanded to move to the home, end and intermediate positions, respectively.

Positioning motion

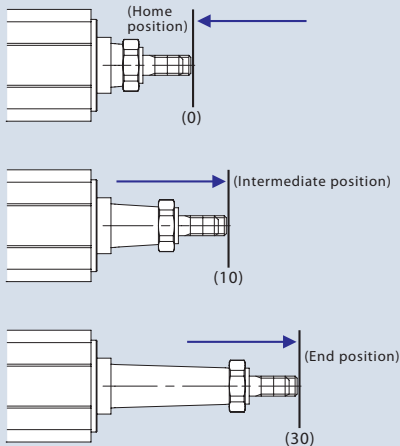

Input signal

Input 0	ON
Input 1	OFF
Input 2	OFF
Input 3	—

When Input 0 is turned ON, the rod moves to the home position at the specified speed.

Input signal

Input 0	OFF
Input 1	OFF
Input 2	ON
Input 3	—

When Input 2 is turned ON, the rod moves to the intermediate position at the specified speed.

Input signal

Input 0	OFF
Input 1	ON
Input 2	OFF
Input 3	—

When Input 1 is turned ON, the rod moves to the end position at the specified speed.

PIO pattern 5 (continuous cycle operation)

This PIO pattern involves continuous cycling between 2 positions—the end and home positions. When Input 0 (continuous operation signal) is turned ON, the rod continuously moves between the specified 2 positions. If Input 0 is turned OFF while in motion, it stops after reaching the current destination.

Positioning motion

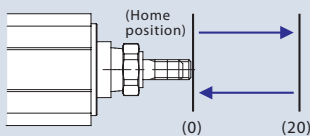

Input signal

Input 0	ON
Input 1	—
Input 2	—
Input 3	—

When Input 0 is turned ON, the rod moves continuously between the end and home positions at the specified speed.



I/O signal table															
Pin No.	Cable color	PIO pattern number		0		1		2		3		4		5	
		PIO pattern name		Standard 2-position travel		Speed change		Position change		2-input 3-position travel		3-input 3-position travel		Continuous cycle operation	
		Solenoid type		Single	Double	Single	Double	Single	Double	—		—		—	
1	Brown	COM		24V		24V		24V		24V		24V		24V	
2	Red	COM		0V		0V		0V		0V		0V		0V	
3	Orange	Input	0	ST0	ST0	ST0	ST0	ST0	ST0	ST0	ST0	ST0	ST0	ASTR	
4	Yellow		1	*STP	ST1(—)	*STP	ST1(—)	*STP	ST1(—)	*STP	ST1(—)	ST1	ST1(—)	—/*STP	
5	Green		2	—(RES)		SPDC (RES)		CN1 (RES)		—(RES)		ST2 (RES)		—(RES)	
6	Blue	Output	3	—/SON		—/SON		—/SON		—/SON		—/SON		—/SON	
7	Purple		0	LS0/PE0	LS0/PE0	LS0/PE0	LS0/PE0	LS0/PE0	LS0/PE0	LS0/PE0	LS0/PE0	LS0/PE0	LS0/PE0	LS0/PE0	LS0/PE0
8	Gray		1	LS1/PE1	LS1/PE1	LS1/PE1	LS1/PE1	LS1/PE1	LS1/PE1	LS1/PE1	LS1/PE1	LS1/PE1	LS1/PE1	LS1/PE1	LS1/PE1
9	White		2	HEND/SV	HEND/SV	HEND/SV	HEND/SV	HEND/SV	HEND/SV	LS2/PE2	LS2/PE2	LS2/PE2	LS2/PE2	HEND/SV	HEND/SV
10	Black	3	*ALM/SV	*ALM/SV	*ALM/SV	*ALM/SV	*ALM/SV	*ALM/SV	*ALM/SV	*ALM/SV	*ALM/SV	*ALM/SV	*ALM/SV	*ALM/SV	

Note: The above signals marked with * are normally ON and turn OFF when active.

Specification table

Item	Specifications								
Controller type	PSEP				ASEP				
	C		CW		C		CW		
Connectable actuators	RCP2/RCP3 series actuators				RCA/RCA2/RCL series actuators				
Number of control axes	1 Axis								
Operating method	Positioner type								
Number of positions	2-positions/ 3-positions (4-positions *2)								
Backup memory	EEPROM								
I/O connector	10-pin connector								
Number of I/O points	4 input points/4 output points								
I/O power supply	External supply DC24V±10%								
Dedicated type for serial communication	RS485 1ch								
Peripheral device communication cable	CB-APSEP-PIO□□□	CB-APSEP-W-PIO□□□	CB-APSEP-PIO□□□	CB-APSEP-PIO□□□	CB-APSEP-PIO□□□	CB-APSEP-PIO□□□	CB-APSEP-PIO□□□	CB-APSEP-PIO□□□	
Position detection method	Incremental encoder (Attaching an absolute battery unit makes the simple absolute specification possible. *3)								
Motor-encoder cable	RCP2 connection-use	CB-PSEP-MPA□□□				(Connection not possible)			
	RCA connection-use	(Connection not possible)				CB-ASEP-MPA□□□			
	RCP3/RCA2 connection-use	CB-APSEP-MPA□□□							
	RCP2 small rotary connection-use	CB-RPSEP-MPA□□□				Connection not possible			
Input voltage	DC24V±10%								
Control power supply capacity	0.5A (0.8A for the simple absolute specification)								
Motor power supply capacity	Motor size	Rated	Max. (*4)	Motor power output	Rated	Max			
						Power-saving (*5)	Standard (*6), high acceleration/ deceleration		
	20P	0.4A	2.0A	2W	0.8A	Not specified	4.6A		
	28P	0.4A	2.0A	5W	1.0A	Not specified	6.4A		
	35P	1.2A	2.0A	10W (RCL-use)	1.3A	Not specified	6.4A		
	42P	1.2A	2.0A	10W (RCA/RCA2-use)	1.3A	2.5A	4.4A		
	56P	1.2A	2.0A	20W	1.3A	2.5A	4.4A		
	—	—	—	20W (20S motor-use)	1.7A	3.4A	5.1A		
—	—	—	30W	1.3A	2.2A	4.4A			
Inrush current (*1)	Max.10A								
Amount of heat generated	8.4W				9.6W				
Dielectric strength voltage	DC500V 1MΩ								
Vibration resistance	XYZ directions	10~57Hz One-side width 0.035mm (continuous), 0.075mm (intermittent)						58~150Hz 4.9m/s ² (continuous), 9.8m/s ² (intermittent)	
Ambient operating temperature	0 to 40°C								
Ambient operating humidity	10~85% RH (non-condensing)								
Ambient operating atmosphere	Free from corrosive gases								
Protection Class	IP20		IP53 (*7)		IP20		IP53 (*7)		
Weight	Approx. 130g		Approx. 160g		Approx. 130g		Approx. 160g		

(*1) Upon power-ON, an electrical current of 5 to 12 times as much as the rated current, called "in rush current" flows for 1 to 2 ms. Note that the amount of inrush current varies based on the impedance of power source lines.
 (*2) This applies to the case where two position data points are set at each of the end and home positions during a "position change" motion pattern process.
 (*3) The simple absolute type controllers cannot be used for the linear servo type.
 (*4) After the motor power has been turned on, the motor is excited and it performs a phase detection operation. During this time, the current will be maximized. (Generally for about 100ms)
 However, if after the motor power is off, it is turned on again, approximately 6.0A current will flow. (For approximately 1~2 ms)
 (*5) The current will be maximized when the motor is excited and it performs a phase detection operation or during a collision or a motion constraint. The phase detection operation can take up to 10 seconds during which it is necessary to require the listed current.
 (*6) The current will be maximized during acceleration, deceleration, a collision, or a motion constraint. The longest time will be during a collision or a motion constraint. The listed current is required until an overload is detected.
 (*7) The bottom surface is excluded.

Names

ASEP, PSEP Incremental type

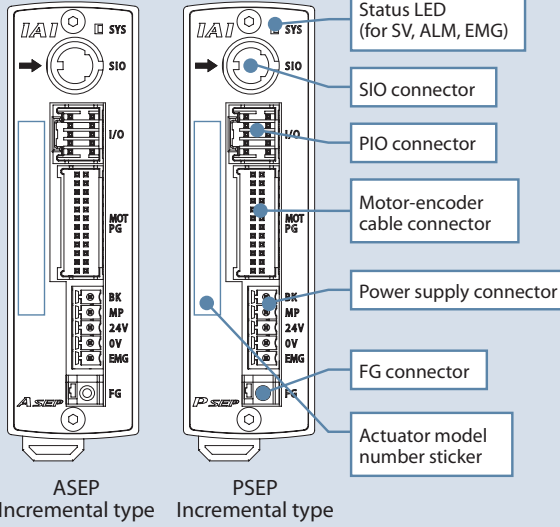

ASEP, PSEP Simple absolute type

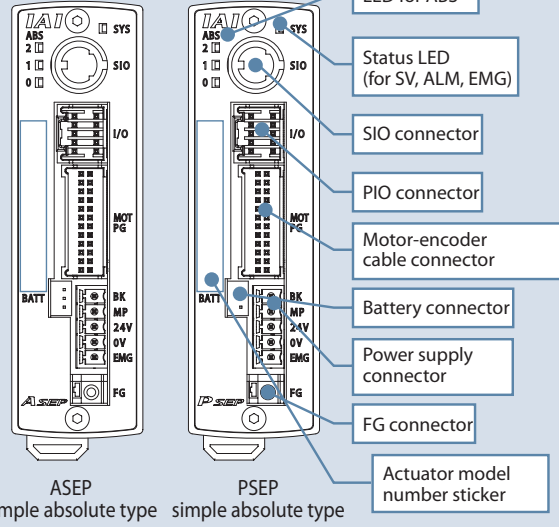

Mini Slider type
Mini Rod type
Mini Table type
Mini Linear Servo type
Controller

External dimensions

Standard type

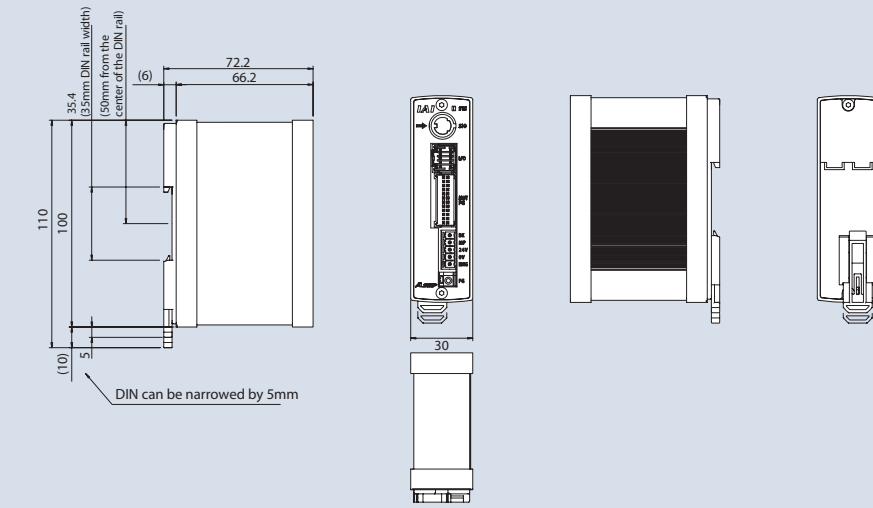

Dustproof type

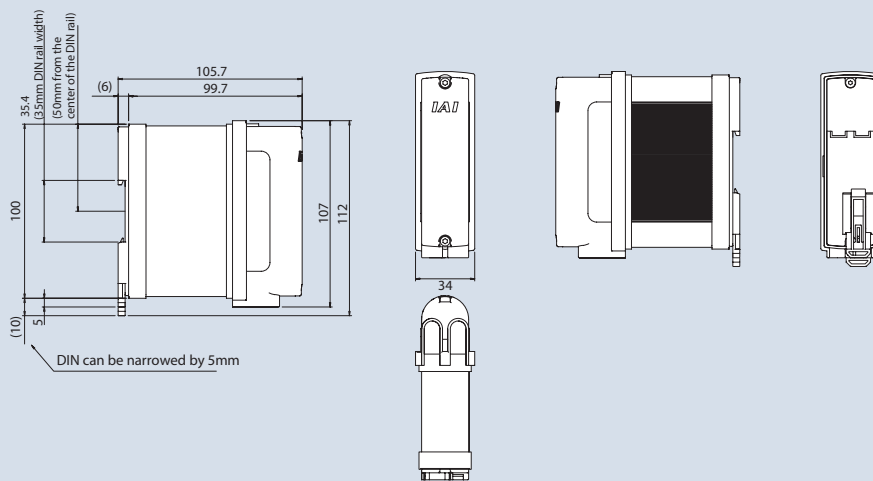

Option

CON-PTA Touch-panel Teaching Pendant for Position Controller

Developed based on the design of the popular CON-PT series adopting an easy-to-use interactive touch-panel menu screen, this new data input device supports various functions offered by the PCON-CA controller.



CON-PTA

1. Color screen for greater ease of view
2. Supporting the takt time minimization function and maintenance information checking/ input functions of the PCON-CA
3. Position, parameters and other data can be saved in a SD card
4. Built-in clock function records the date & time of each event; data can then be saved in a SD card.

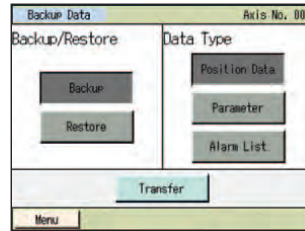
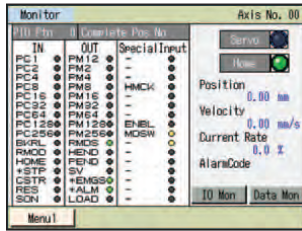

Model Numbers/Specifications

Item	Description		
Model number	CON-PTA-C-ENG	CON-PDA-C-ENG	CON-PGA-C-S-ENG
Type	Standard type	Enable switch type	Safety-category compliant type
Connectable controllers	ACON/PCON/SCON/RACON/RPCON ASEP/PSEP AMEC/PMEC ERC2 (*1) /ERC3		
3-position enable switch	×	○	○
Functions	<ul style="list-style-type: none"> • Position data input/editing • Moving function (moving to set positions, jogging/inching) • Parameter editing • Monitoring (current position, current speed, I/O signals, alarm code, alarm generation time) • Saving/reading data to/from external SD cards (position data parameters, alarm list) • Takt time minimization function • Maintenance information (total number of movements, total distance travelled, etc.) 		
Display	65536 colors (16-bit colors), white LED backlight		
Ambient operating temperature/humidity	0 to 40°C, 85% RH or less (Non-condensing)		
Environmental resistance	IP40 or equivalent		
Mass	Approx. 570g		Approx. 600g
Cable length	5m		
Accessories	Stylus	Stylus	Stylus, TP adapter (Model number: RCB-LB-TG) Dummy plug (Model number: DP-4) Controller cable (Model number: CB-CON-LB005)

*1 Among the ERC2 series, only the actuators bearing 4904 or greater number stamped on the serial number label can be connected.

Name of each part/Outer dimensions

Option

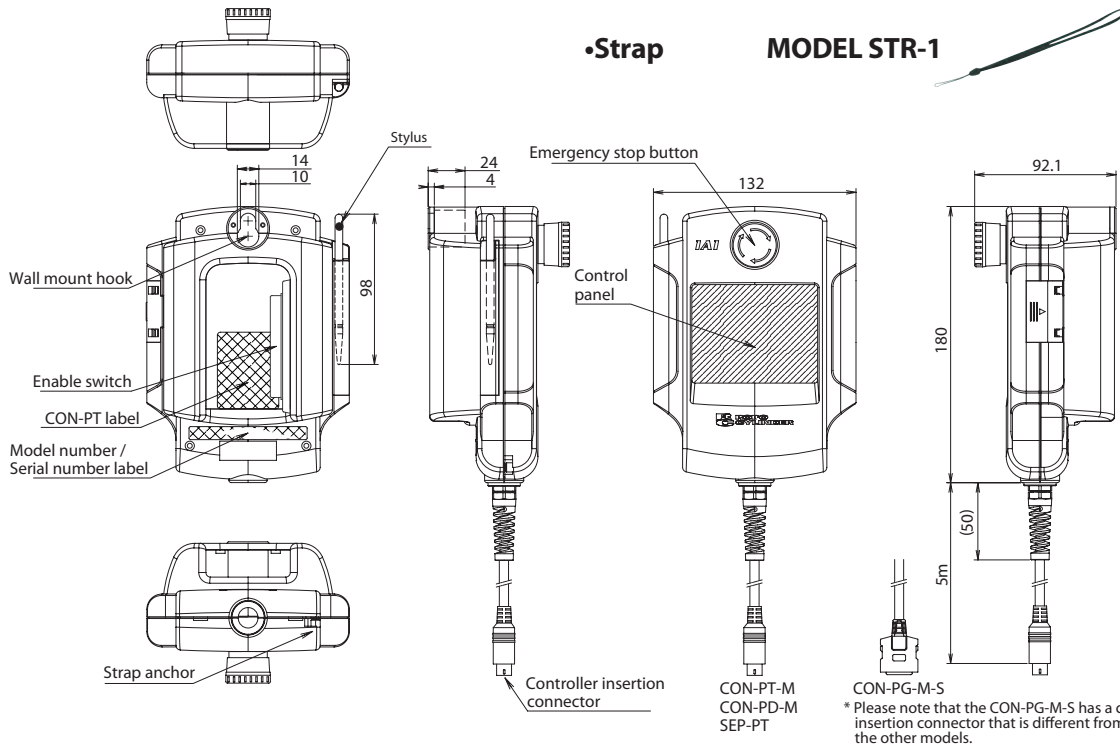

Mini Slider type
Mini Rod type
Mini Table type
Mini Linear Servo type
Controller

Wiring Diagram of CON-PGA-C-S

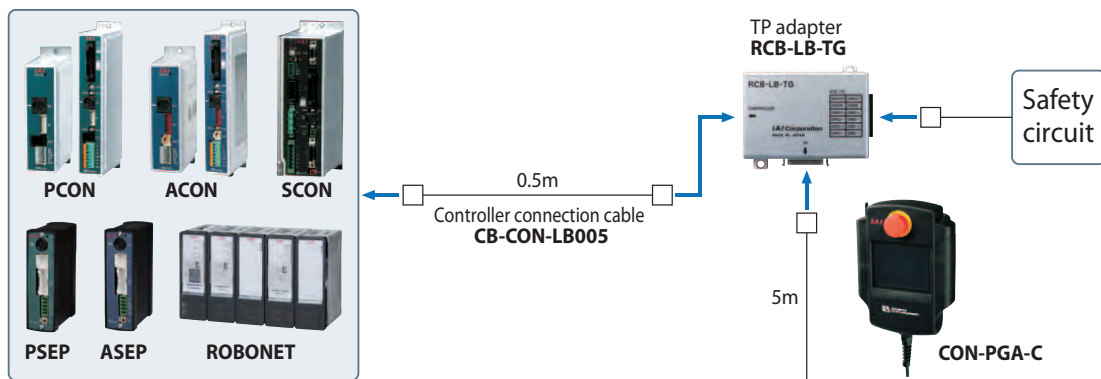

Option

PC software (Windows only)

Features This startup support software provides functions to input positions, perform test operations and monitor data, among others. Incorporating all functions needed to make adjustments, this software helps shorten the initial startup time.

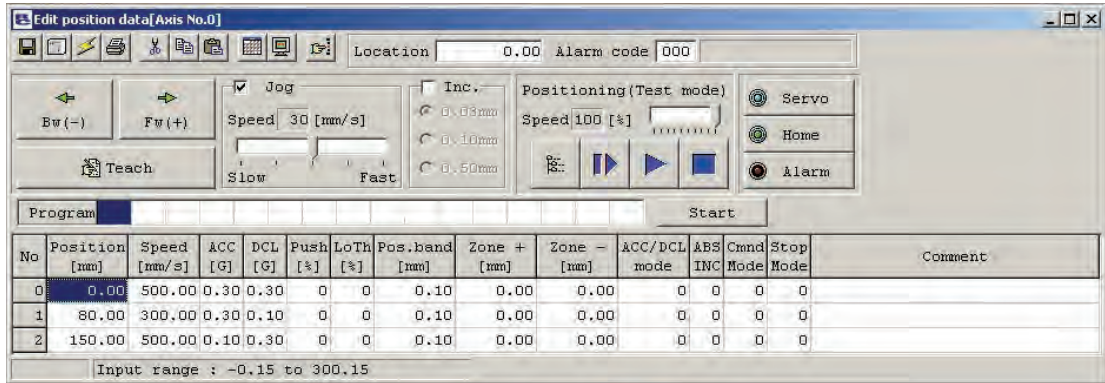

Model RCM-101-MW
(With external equipment communication cable + RS232 conversion unit)



Configuration

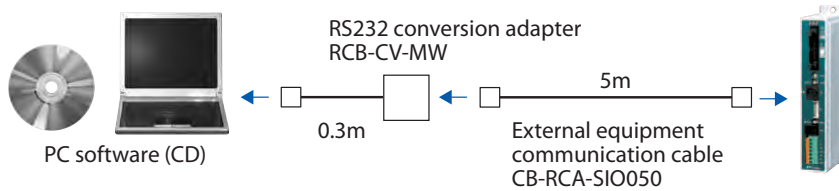

Model RCM-101-USB
(With external equipment communication cable + USB conversion adapter + USB cable)



Configuration

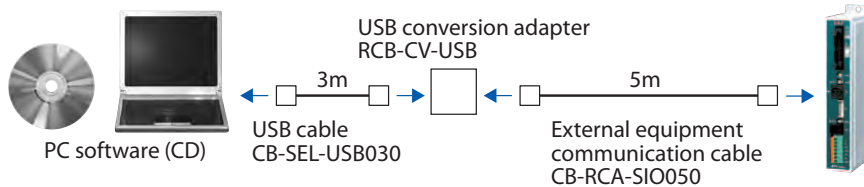

Absolute battery unit for SEP controllers

Description Supplied with the PSEP and ASEP simple absolute controllers. This is a battery unit used for backing up the current position data.

Model **SEP-ABU** (standard type)
SEP-ABU-W (dustproof type)

Specifications

Item	Specifications			
Ambient operating temperature and humidity	0 to 40°C (about 20°C preferred), 95% RH or below (non-condensing)			
Ambient operating environment	Free from corrosive gases			
Absolute battery (*1)	Model: AB-7(Ni-MH battery/approx. 3-year life)			
Controller-absolute battery unit cable (*1)	Model: CB-APSEP-AB005 (length 0.5m)			
Weight	Standard type: approx. 230g / Dustproof type: approx. 260g			
Allowable encoder RPM during data retention (*2)	800rpm	400rpm	200rpm	100rpm
Position data retention time (*2)	120h	240h	360h	480h

(*1) The absolute battery unit comes with a cable to connect the controller and the absolute battery unit.

(*2) Position data retention time changes with the allowable encoder RPMs during data retention.

(800rpm→120h, 400rpm→240h, 200rpm→360h, 100rpm→480h)

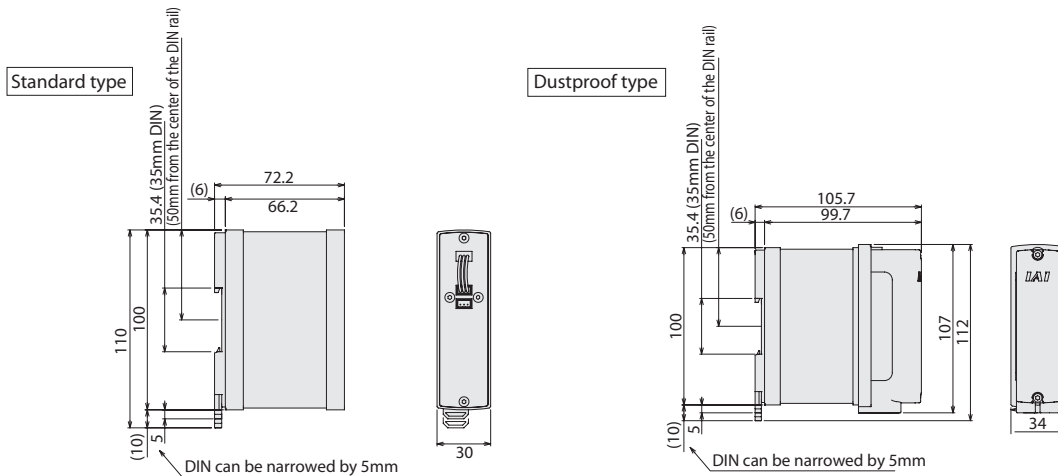

Precautions related to controllers and options:

- When mounting the controller to a DIN rail, use the supplied spacer between the controllers to prevent them from contacting each other, to deal with heat dissipation. (See Fig. 1)
- When mounting the absolute battery units and controllers, place the absolute battery below the controllers. (See Fig. 2) If there is not enough space below the controllers, mount the absolute battery units in such a way that the temperature around the controllers stays at 40°C or below.

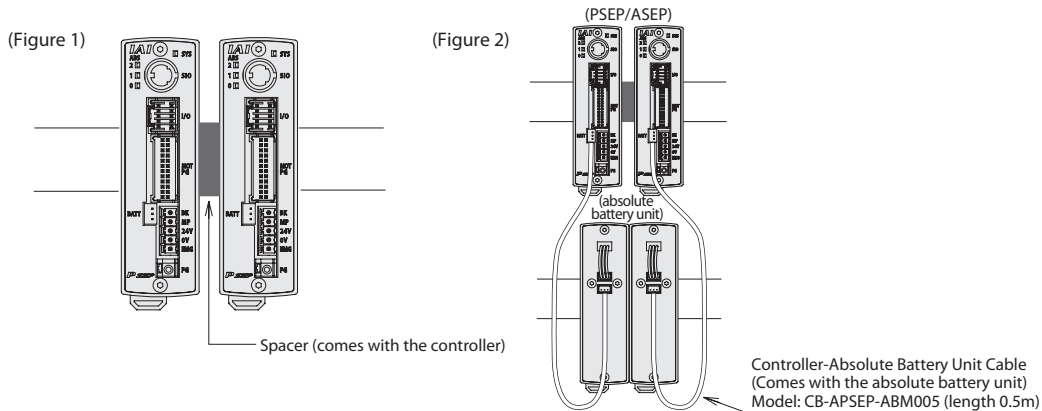

Maintenance parts

Please refer to the models listed below when arrangements such as cable replacement are needed after purchasing the product.

(RCP3/RCA2/RCL) - (PSEP/ASEP) Integrated motor-encoder connection cable

Model **CB-APSEP-MPA**

* indicated the cable length (L)
Lengths up to 20m can be specified Example 080=8m

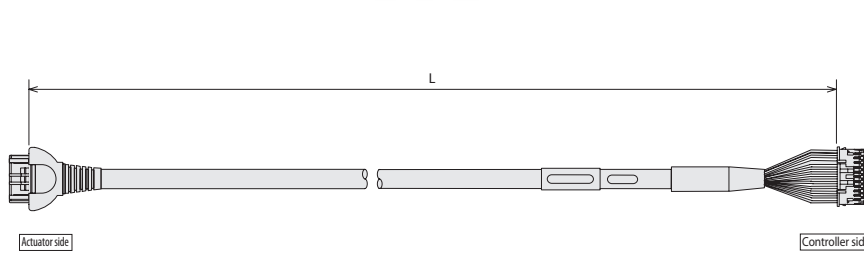

Minimum bend radius $r = 68\text{mm}$ or larger (when movable unit is used)

Mechanical side Pin number	(PCON)(ACON)	Controller side Pin number
A1	Black (ØA)(U)	1
B1	White (VMM)(V)	2
A2	Brown (Ø/A)(W)	5
B2	Green (ØB)(-)	3
A3	Yellow (VMM)(-)	4
B3	Red (Ø/B)(-)	6
A4	Orange (LS+)(BK+)	7
B4	Gray (LS-)(BK-)	8
A6	White (-)(A+)	11
B6	Yellow (-)(A-)	12
A7	Red (A+)(B+)	13
B7	Green (A-)(B-)	14
A8	Black (B+)(Z+)	15
B8	Brown (B-)(Z-)	16
A5	Black (label)(BK+)(LS+)	9
B5	Brown (label)(BK-)(LS-)	10
A9	Green (label)(GNLS)(GNLS)	20
B9	Red (label)(VPS)(VPS)	18
A10	White (label)(VCC)(VCC)	17
B10	Yellow (label)(GND)(GND)	19
A11	NC	21
B11	Shield (FG)(FG)	24
	NC	22
	NC	23

(RCP2) - (PSEP) Integrated motor-encoder connection cable

Model **CB-PSEP-MPA**

* indicated the cable length (L)
Lengths up to 20m can be specified Example 080=8m

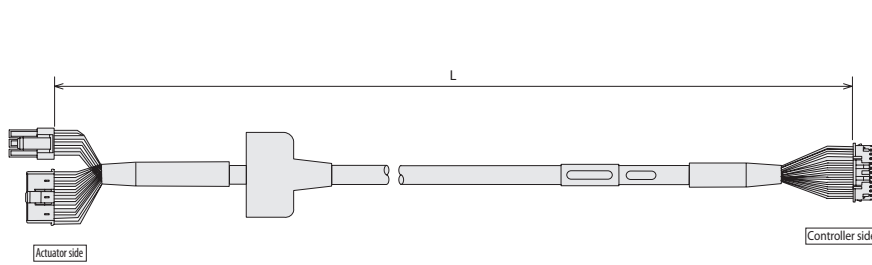

Minimum bend radius $r = 68\text{mm}$ or larger (when movable unit is used)

Mechanical side Pin number		Controller side Pin number
1	Black (ØA)	1
2	White (VMM)	2
4	Red (ØB)	3
5	Green (VMM)	4
3	Brown (Ø/A)	5
6	Yellow (Ø/B)	6
16	Orange (BK+)	7
17	Gray (BK-)	10
5	NC	11
6	NC	12
13	Black (LS+)	7
14	Brown (LS-)	8
1	White (A+)	11
2	Yellow (A-)	14
3	Red (B+)	15
4	Green (B-)	16
10	Yellow (label)(VPS)	17
11	Red (label)(GND)	19
9	Green (label)(GND)	20
12	NC	21
15	NC	22
7	NC	23
8	NC	24
18	Shield (FG)	

(RCA) - (ASEP) Integrated motor-encoder connection cable

Model **CB-ASEP-MPA**

* indicated the cable length (L)
Lengths up to 20m can be specified Example 080=8m

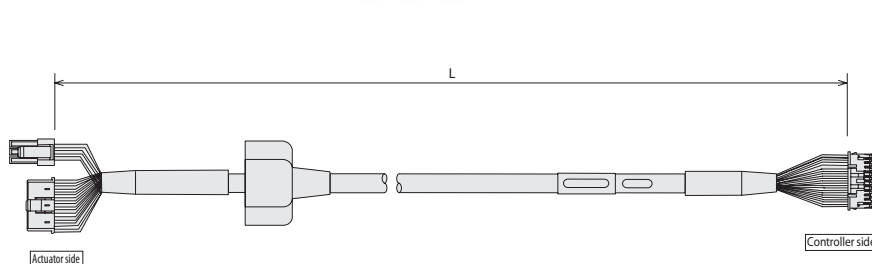

Minimum bend radius $r = 68\text{mm}$ or larger (when movable unit is used)

Mechanical side Pin number		Controller side Pin number
1	Red (U)	1
2	Yellow (V)	2
	NC	3
3	Black (W)	4
	NC	5
18	Orange (BK+)	6
17	Gray (BK-)	7
7	Black (LS+)	8
16	Brown (LS-)	9
1	White (A+)	10
2	Yellow (A-)	11
3	Red (B+)	12
4	Green (B-)	13
10	Black (label)(Z+)	14
11	Brown (label)(Z-)	15
14	White (label)(VCC)	16
13	Yellow (label)(VPS)	17
15	Red (label)(GND)	18
6	Green (label)(Spare)	19
5	NC	20
8	NC	21
12	NC	22
9	Shield (FG)	23
		24

(RCP2 small rotary) - (PSEP) - Integrated motor-encoder connection cable

Model **CB-RPSEP-MPA**

* indicated the cable length (L)
Lengths up to 20m can be specified Example) 080=8m

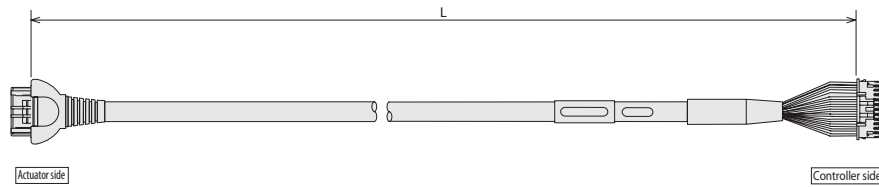

Minimum bend radius $r = 68\text{mm}$ or larger (when movable unit is used)

Mechanical side		Controller side	
Pin number		Pin number	
A1	Black [ØA]	1	
B1	White [VMM]	2	
A2	Brown [Ø/A]	5	
B2	Green [ØB]	3	
A3	Yellow [VMM]	4	
B3	Red [Ø/B]	6	
A6	Orange [LS+]	7	
B6	Gray [LS-]	8	
A7	Red [A+]	13	
B7	Green [A-]	14	
A8	Black [B+]	15	
B8	Brown [B-]	16	
A4	NC	7	
B4	NC	8	
A5	Black (label)[BK-]	9	
B5	Brown (label)[BK-]	10	
A9	Green (label)[GNDLS]	20	
B9	Red (label)[VPS]	18	
A10	White (label)[VCC]	17	
B10	Yellow (label)[GND]	19	
A11	NC	21	
B11	Shield [FG][FG]	22	
	NC	23	

- Mini Slider type
- Mini Rod type
- Mini Table type
- Mini Linear Servo type
- Controller

I/O cable for PSEP-C/ASEP-C

Model **CB-APSEP-PIO**

* indicated the cable length (L)
Lengths up to 10m can be specified Example) 080=8m

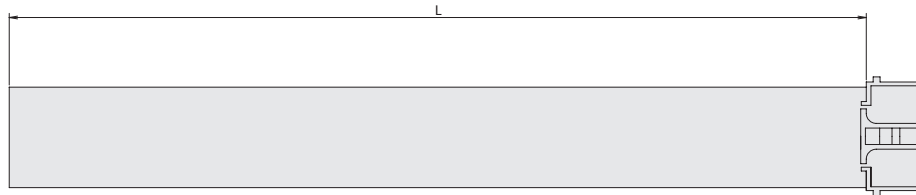

51353-1000(MOLEX)			
No.	Signal	Color	Wiring
1	24V	Brown	
2	0V	Red	
3	INO	Orange	
4	IN1	Yellow	
5	IN2	Green	
6	IN3	Blue	(crimped)
7	OUT0	Purple	
8	OUT1	Gray	
9	OUT2	White	
10	OUT3	Black	

I/O cable for PSEP-CW/ASEP-CW

Model **CB-APSEPW-PIO**

* indicated the cable length (L)
Lengths up to 10m can be specified Example) 080=8m

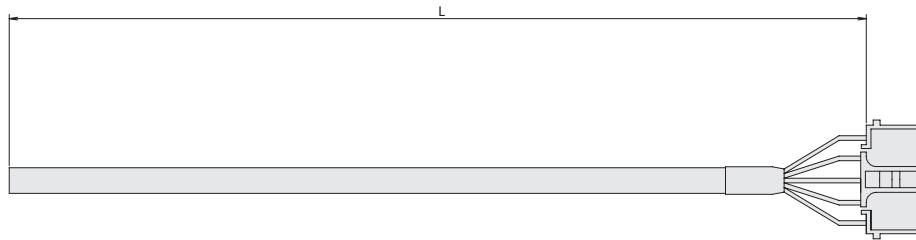

51353-1000(MOLEX)			
No.	Signal	Color	Wiring
1	24V	Brown	
2	0V	Brown-White	
3	INO	Red	
4	IN1	Red-White	
5	IN2	Yellow	
6	IN3	Yellow-White	(crimped)
7	OUT0	Green	
8	OUT1	Green-White	
9	OUT2	Black	
10	OUT3	Black-White	



RCS2/RCS3/Single-axis Robot/
Linear Servo Actuator Position Controller

Feature

1 Supporting major field networks <Optional function>

Direct connection is now possible not only to DeviceNet, CC-Link (*1) and PROFIBUS-DP, but also to MECHATROLINK, CompoNet, EtherCAT and EtherNet/IP. The actuator can also be operated by specifying coordinate values directly via a field network.
(*1) CC-Link was changed from remote I/O to remote device.



2 Vibration control function <Standard function>

A vibration control function has been added that suppresses vibration of the work part installed on the slider when the actuator's slider moves. This function shortens the time the actuator waits for vibration to settle, and consequently shortens the cycle time.

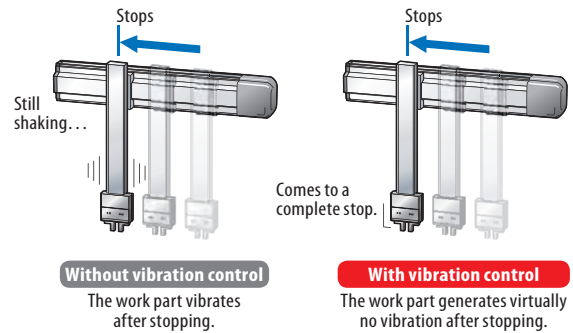

3 Checking when to maintain based on the total number of movements and total distance travelled <Standard function>

The total number of actuator movements and the total distance travelled are calculated and recorded in the controller, and when the predetermined count or distance is exceeded, a signal is output to an external device. You can use this function to check when the actuator needs re-greasing or periodic inspection.



4 Keeping the alarm generation times with the calendar function <Standard function>

The clock function has been added to facilitate the analysis of the alarms because the time and date of each alarm that has occurred is now shown on the alarm history screen. (The time and date data is retained for 10 days.)

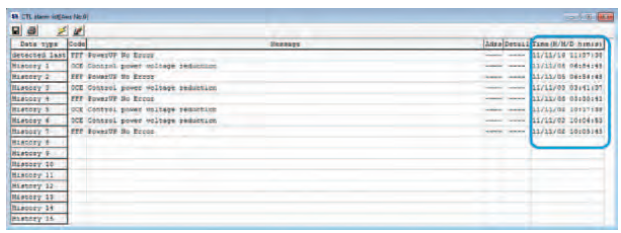

Details of the SCON-CA Controllers

List of Models								
Model	SCON-CA							
External view								
I/O type	Standard specification	Network connection specification (optional)						
I/O type specification	PIO connection specification (*1)	DeviceNet	CC-Link	PROFIBUS-DP	CompoNet	MECHATROLINK	EtherCAT	EtherNet/IP
I/O type code	NP/PN	DV	CC	PR	CN	ML	EC	EP
Applicable encoder type	Incremental	Absolute	Incremental/Absolute					
Standard price	20~150W	—	—	—	—	—	—	—
	200W	—	—	—	—	—	—	—
	300~400W	—	—	—	—	—	—	—
	600W	—	—	—	—	—	—	—
	750W	—	—	—	—	—	—	—
750W (for force control)	—	—	—	—	—	—	—	—

(*1) If the controller is operated in the pulse-train mode, only an incremental encoder can be used. *The network connection specification type will not be able to operate with the PIO or Pulse train mode.

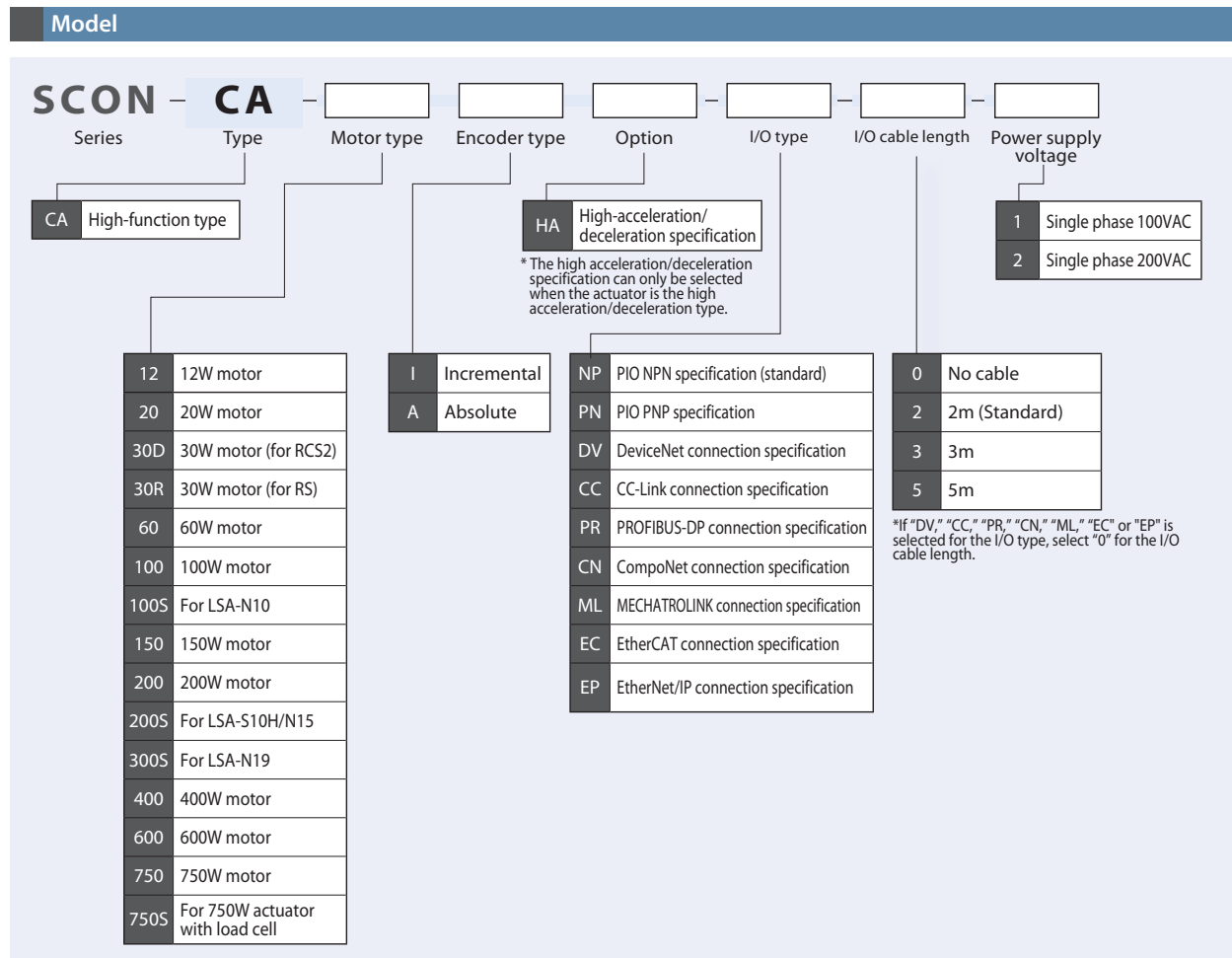

System Configuration

- Mini Slider type
- Mini Rod type
- Mini Table type
- Mini Linear Servo type
- Controller

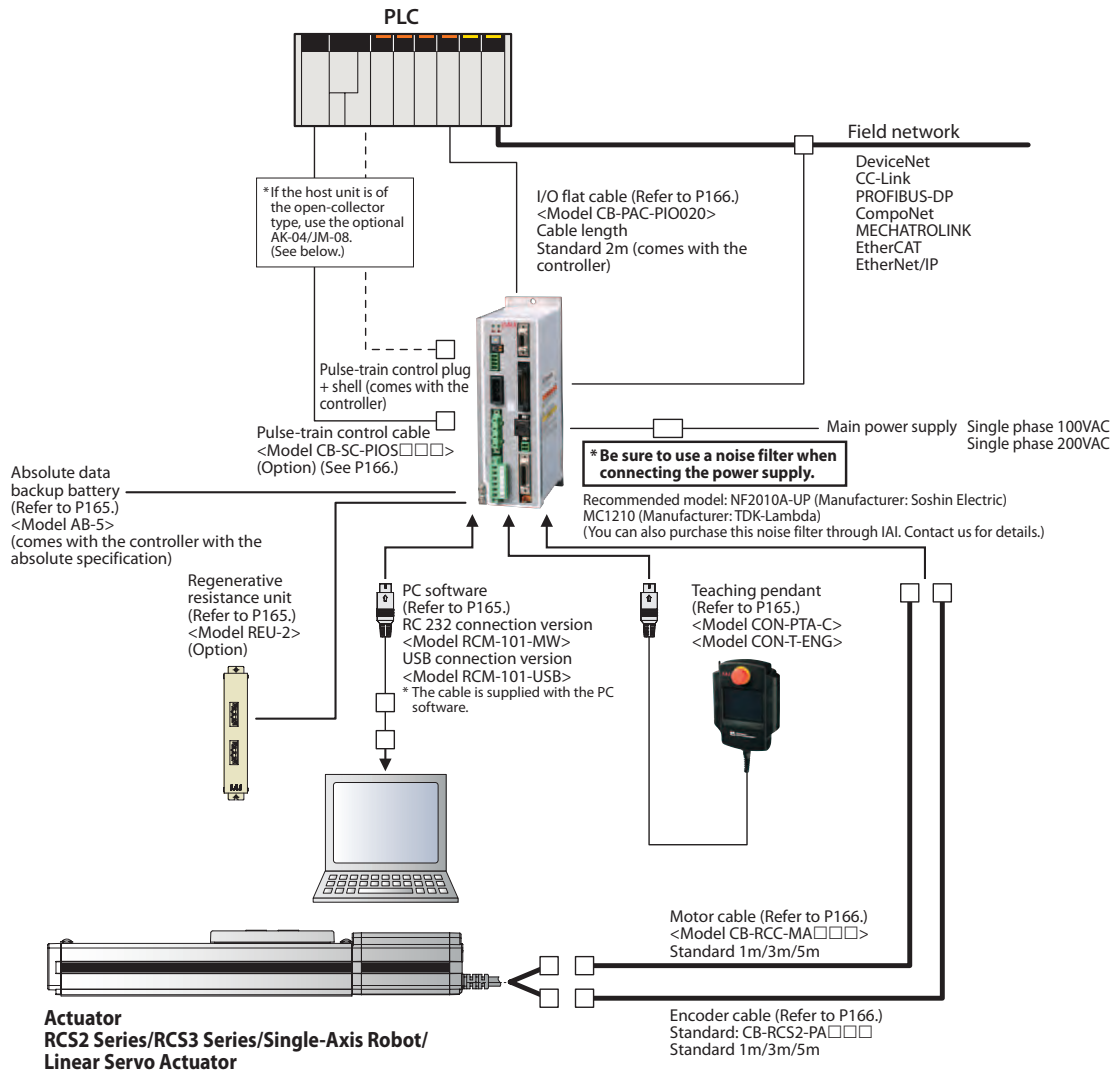

● Pulse Converter: AK-04

Open-collector command pulses are converted to differential command pulses. Use this converter if the host controller outputs open-collector pulses.

■ Specification

Item	Specification
Input power	24 VDC±10% (Max. 50mA)
Input pulse	Open-collector (Collector current: 12mA max.)
Input frequency	200kHz or less
Output pulse	Differential output (10mA max.) (26C31 or equivalent)
Mass	10g or less (excluding cable connectors)
Accessories	37104-3122-000L (e-CON connector) x 2 Applicable wire: AWG Nos. 24 to 26

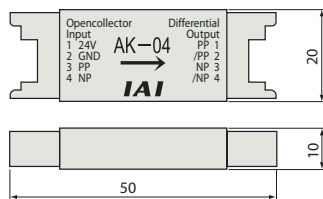

● Pulse Converter: JM-08

Difference feedback pulses are converted to open-collector feedback pulses. Use this converter if the host controller inputs open-collector pulses.

■ Specification

Item	Specification
Input power	24 VDC±10% (Max. 50mA)
Input pulse	Differential input (10 mA max.) (conforming to RS422)
Input frequency	500kHz or less
Output pulse	24-VDC open-collector (Collector current: 25mA max.)
Mass	10g or less (excluding cable connectors)
Accessories	37104-3122-000FL (e-CON connector) x 2 Applicable wire: AWG Nos. 24 to 26

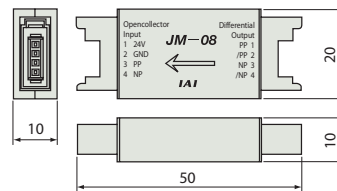

Operation Modes

With this controller, you can select a desired control method from the two modes of positioner mode and pulse-train control mode. In the positioner mode, you can enter position data (target position, speed, acceleration, etc.) in the controller under the desired numbers and then specify each number externally via an I/O (input/output signal) to operate the actuator. Also, in the positioner mode, you can select the desired operation mode from the eight modes using the parameter. In the pulse-train control mode, you can control the travel, speed, acceleration, etc., by sending pulses from an external pulse generator.

Mode	Number of positioning points	Features
Positioner mode	Positioning mode	64 points Standard factory-set mode. Specify externally a number corresponding to the position you want to move to, to operate the actuator.
	Teaching mode	64 points In this mode, you can move the slider (rod) via an external signal and register the stopped position in the position data table.
	256-point mode	256 points In this mode, the number of positioning points available in the positioning mode has been increased to 256 points.
	512-point mode	512 points In this mode, the number of positioning points available in the positioning mode has been increased to 512 points.
	Solenoid value mode 1	7 points In this mode, the actuator can be moved only by turning signals ON/OFF, just like you do with an air cylinder of solenoid valve type.
	Solenoid value mode 2	3 points In this mode, the output signal is set to the same as the air cylinder auto switch in the solenoid valve mode.
	Force mode 1	32 points In this mode, you can move to positions under force control in the positioning mode. (Up to 32 positioning points are available.)
	Force mode 2	5 points In this mode, you can move to positions under force control in the solenoid valve mode. (Up to five positioning points are available.)
Pulse-train control mode	—	There is no need to enter position data in the controller, and the customer can operate the actuator freely based on custom control.

I/O Signal Table * You can select one of nine types of I/O signal assignments.

Pin No.	Category		Parameter (PIO pattern) selection								Pulse-train mode
			0	1	2	3	4	5	6	7	
		Positioning point	Positioning mode	Teaching mode	256-point mode	512-point mode	Solenoid valve mode 1	Solenoid valve mode 2	Force mode 1	Force mode 2	Standard mode
1A	24V		64 points	64 points	256 points	512 points	7 points	3 points	32 points	5 points	—
2A	24V		P24								P24
3A	—		NC								NC
4A	—		NC								NC
5A	Input	IN0	PC1	PC1	PC1	PC1	ST0	ST0	PC1	ST0	SON
6A		IN1	PC2	PC2	PC2	PC2	ST1	ST1(JOG+)	PC2	ST1	RES
7A		IN2	PC4	PC4	PC4	PC4	ST2	ST2(-)	PC4	ST2	HOME
8A		IN3	PC8	PC8	PC8	PC8	ST3	—	PC8	ST3	TL
9A		IN4	PC16	PC16	PC16	PC16	ST4	—	PC16	ST4	CSTP
10A		IN5	PC32	PC32	PC32	PC32	ST5	—	—	—	DCLR
11A		IN6	—	MODE	PC64	PC64	ST6	—	—	—	BKRL
12A		IN7	—	JISL	PC128	PC128	—	—	—	—	RMOD
13A		IN8	—	JOG+	—	PC256	—	—	CLBR	CLBR	—
14A		IN9	BKRL	JOG-	BKRL	BKRL	BKRL	BKRL	BKRL	BKRL	—
15A		IN10	RMOD	RMOD	RMOD	RMOD	RMOD	RMOD	RMOD	RMOD	—
16A		IN11	HOME	HOME	HOME	HOME	HOME	—	HOME	HOME	—
17A		IN12	*STP	*STP	*STP	*STP	*STP	—	*STP	*STP	—
18A		IN13	CSTR	CSTR/PWRT	CSTR	CSTR	—	—	CSTR	—	—
19A		IN14	RES	RES	RES	RES	RES	RES	RES	RES	—
20A	IN15	SON	SON	SON	SON	SON	SON	SON	SON	—	
1B	Output	OUT0	PM1	PM1	PM1	PM1	PE0	LS0	PM1	PE0	PWR
2B		OUT1	PM2	PM2	PM2	PM2	PE1	LS1(TRQS)	PM2	PE1	SV
3B		OUT2	PM4	PM4	PM4	PM4	PE2	LS2(-)	PM4	PE2	INP
4B		OUT3	PM8	PM8	PM8	PM8	PE3	—	PM8	PE3	HEND
5B		OUT4	PM16	PM16	PM16	PM16	PE4	—	PM16	PE4	TLR
6B		OUT5	PM32	PM32	PM32	PM32	PE5	—	TRQS	TRQS	*ALM
7B		OUT6	MOVE	MOVE	PM64	PM64	PE6	—	LOAD	LOAD	*EMGS
8B		OUT7	ZONE1	MODES	PM128	PM128	ZONE1	ZONE1	CEND	CEND	RMDS
9B		OUT8	PZONE/ZONE2	PZONE/ZONE1	PZONE/ZONE1	PM256	PZONE/ZONE2	PZONE/ZONE2	PZONE/ZONE1	PZONE/ZONE1	ALM1
10B		OUT9	RMDS	RMDS	RMDS	RMDS	RMDS	RMDS	RMDS	RMDS	ALM2
11B		OUT10	HEND	HEND	HEND	HEND	HEND	HEND	HEND	HEND	ALM4
12B		OUT11	PEND	PEND/WEND	PEND	PEND	PEND	—	PEND	PEND	ALM8
13B		OUT12	SV	SV	SV	SV	SV	—	SV	SV	*OVLW/*ALML
14B		OUT13	*EMGS	*EMGS	*EMGS	*EMGS	*EMGS	*EMGS	*EMGS	*EMGS	—
15B		OUT14	*ALM	*ALM	*ALM	*ALM	*ALM	*ALM	*ALM	*ALM	ZONE1
16B	OUT15	*BALM	*BALM	*BALM	*BALM	*BALM	*BALM	*BALM	*BALM	ZONE2	
17B	—									—	
18B	—									—	
19B	0V					N				N	
20B	0V					N				N	

* In the above table, signals in () represent functions available before the home return.
* In the above table, signals preceded by * are turned OFF while the actuator is operating.





Explanation of the I/O Signal Functions

The table below explains the functions assigned to the controller's I/O signals. The available signals vary depending on the controller type and settings, so use the signal table of each controller to check the functions available with that controller.

Category	Signal abbreviation	Signal name	Description of function
Input	CSTR	PTP strobe (start signal)	The actuator starts moving to the position set by the command position.
	PC1~PC256	Command position number	The position number of the target position is input (binary input).
	BKRL	Forced brake release	The brake is forcibly released.
	RMOD	Operation mode switching	The operation mode can be switched when the MODE switch on the controller is in the AUTO position. (The switch position is AUTO when this signal is OFF, or MANU when the signal is ON.)
	*STP	Pause	The actuator will decelerate to a stop when this signal turns OFF while the actuator is moving. The remaining movement will be suspended while the actuator is stopped and the movement will resume once the signal turns ON.
	RES	Reset	The alarm will be reset when the signal turns ON. The remaining travel can be cancelled by turning this signal ON while the actuator is paused (*STP is OFF).
	SON	Servo ON	The servo is ON while this signal is ON, and remains OFF while this signal is OFF.
	HOME	Home return	When this signal turns ON, the actuator performs home return operation.
	MODE	Teaching mode	When this signal turns ON, the actuator switches to the teaching mode. (Switching will not occur if CSTR, JOG+ and JOG- are all OFF and the actuator is still moving.)
	JISL	Jog/inch switching	When this signal turns OFF, the actuator can be jogged with JOG+ and JOG-. When the signal is ON, the actuator can be inched with JOG+ and JOG-.
	JOG+, JOG-	Jog	When the JISL signal is OFF, the actuator starts jogging in + or - direction upon detection of the ON edge of this signal. If the OFF edge of this signal is detected during jogging, the actuator decelerates to a stop.
	PWRT	Current position write	In the teaching mode, specify a position and then turn this signal ON for at least 20ms, and the current position will be written to the specified position.
	STO~ST6	Start signal	In the solenoid valve mode, the actuator moves to the specified position when this signal turns ON. (The start signal is not required.)
CLBR	Load cell calibration command	Load cell calibration starts when this signal has remained ON for at least 20ms.	
Output	PEND/INP	Positioning complete	This signal turns ON when the actuator enters the in-position band after movement. If the actuator exceeds the in-position band, the PEND signal does not turn OFF, but the INP signal turns OFF. PEND and INP can be switched using a parameter.
	PM1~PM256	Complete position number	The position number of the position reached at the end of positioning is output (binary output).
	HEND	Home return completion	This signal turns ON upon completion of home return.
	ZONE1/ZONE2	Zone	This signal turns ON if the current actuator position is within the range set by the parameter.
	PZONE	Position zone	This signal turns ON when the current actuator position enters the range set in the position data table after position movement. This signal can be used with ZONE1, but PZONE becomes effective only when moving to a specified position.
	RMDS	Operation mode status output	The operation mode status is output. This signal turns ON when the controller is in the manual mode.
	*OVLW	Overload warning	This signal is ON in a normal condition, and turns OFF when the overload warning level is exceeded. (Operation will continue.)
	*ALML	Minor failure alarm	This signal is ON in a normal condition, and turns OFF when a message-level alarm occurs. (Operation will continue.)
	*ALM	Alarm	This signal is ON when the controller is in a normal condition, and turns OFF when an alarm occurs.
	MOVE	Moving	This signal is ON while the actuator is moving (also during home return and push-motion operation).
	SV	Servo ON	This signal is ON while the servo is ON.
	*EMGS	Emergency stop output	This signal is ON when no emergency stop is actuated on the controller, and turns OFF when an emergency stop is actuated.
	*BALM	Absolute battery voltage low warning	If the controller is of the absolute specification, this signal turns OFF when the voltage of the absolute battery drops. (Operation will continue.)
	MODES	Teaching mode output	This signal turns ON when the actuator enters the teaching mode via MODE signal input. It turns OFF once the actuator returns to the normal mode.
	WEND	Write complete	This signal is OFF immediately after switching to the teaching mode, and turns ON once writing is completed according to the PWRT signal. When the PWRT signal turns OFF, this signal also turns OFF.
	PE0~PE6	Current position number	This signal turns ON when the actuator has completed moving to the target position in the solenoid valve mode.
	CEND	Load cell calibration complete	This signal turns ON upon completion of load cell calibration. When the CLBR signal turns OFF, this signal also turns OFF.
	LOAD	Load output judgment signal	During push-motion operation, this signal is output when the current value set for the "threshold" is exceeded within the range of "Zone+" and "Zone-" set in the position data table. The signal is used to determine if press-fitting action has been performed correctly.
TRQS	Torque level output	This signal is output when the motor current reaches the current value set for the "threshold" in the position data table after the slider (rod) has collided with an obstacle, etc., during movement in push-motion operation.	
LS0~LS2	Limit switch output	This signal turns ON when the current actuator position enters the in-position band set before and after the target position. If the home return has already completed, this signal is output even before a movement command is issued or while the servo is OFF.	

* In the above table, signals preceded by * are normally ON and turn OFF while the actuator is operating.

I/O Wiring Diagram

● Positioning mode/Teaching mode/
Solenoid valve mode

PIO connector (NPN specification)

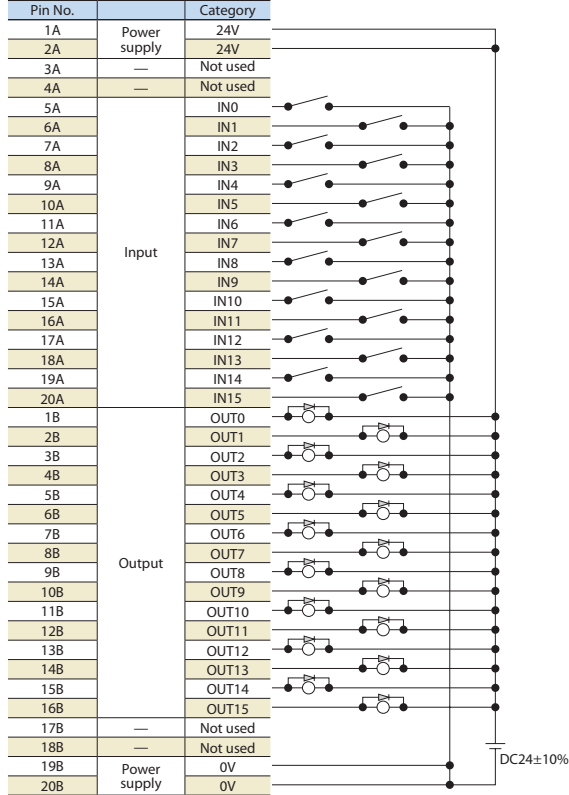

*Connect Pins 1A and 2A to 24V, and Pins 19B and 20B to 0V.

● Pulse Train Mode (Differential Output)

Pulse connector

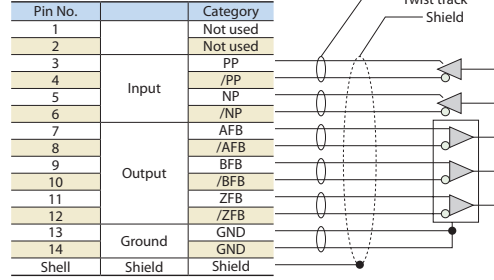

PIO connector (NPN specification)

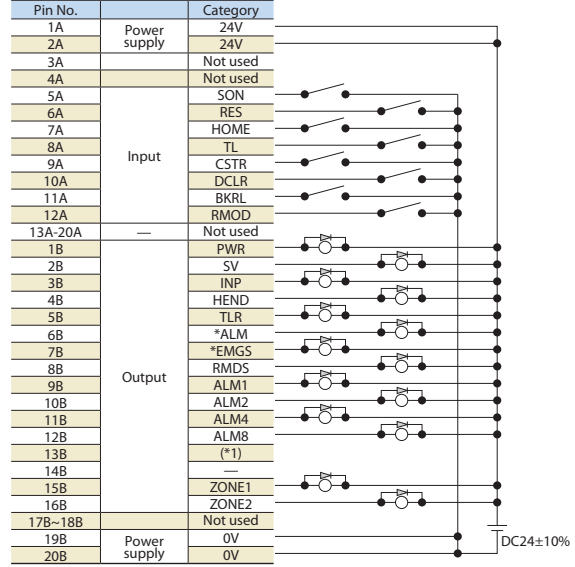

* Be sure to connect to the shell of the twist track cable connected to the PULSE connector. Also keep the cable length to 10m or less.

* Connect Pins 1A and 2A to 24V, and Pins 19B and 20B to 0V (*1)-/*ALML/*OVLW/*BALM (switchable with parameters)

I/O Specification

● Input Part External Input Specifications

Item	Specification
Input voltage	24VDC±10%
Input current	4mA/1 circuit
ON/OFF voltage	ON voltage: 18VDC min. OFF voltage: 6VDC max.
Isolation method	Photocoupler

NPN specification

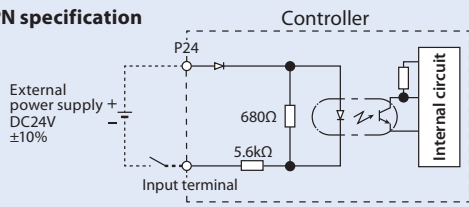

PNP specification

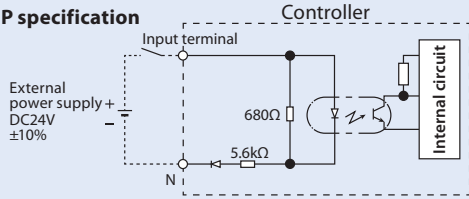

● Output Part External Output Specifications

Item	Specification
Load voltage	24VDC
Maximum load current	100mA/1 point, 400mA/8 points
Leak current	0.1mA max./1 point
Isolation method	Photocoupler

NPN specification

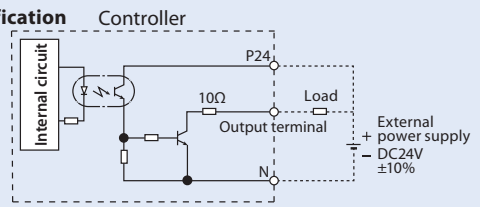

PNP specification

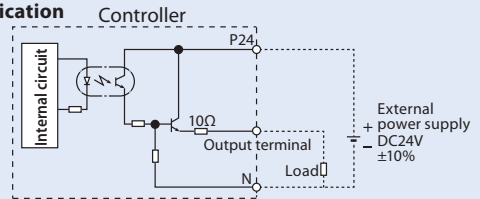

Pulse-Train Type I/O Specification (Differential Line Driver Specification)

Input Part

Maximum number of input pulses : Line driver interface 2.5Mpps
 Isolation method : Photocoupler isolation

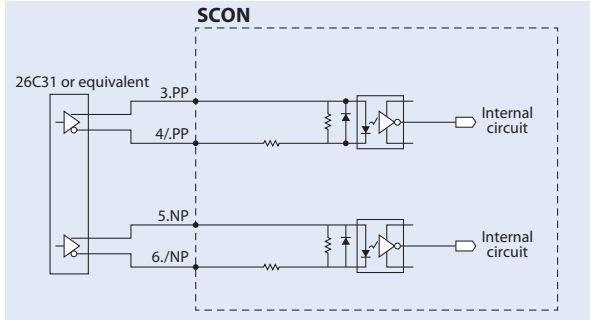

Output Part

Maximum number of output pulses : Line driver interface 2.5Mpps
 Isolation/non-isolation : Non-isolation

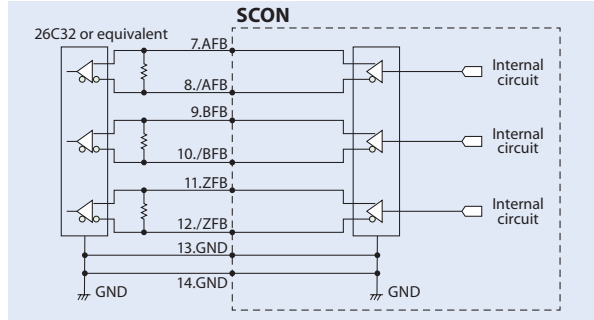

Pulse-Train Type I/O Specification (Open-collector Specification)

The AK-04 (Options) is needed to input pulses. The JM-08 (Options) is needed to output pulses.

Maximum number of input pulses: 200kpps (The AK-04 is needed.)
 Maximum number of output pulses: 200kpps (The JM-08 is needed.)

- * The 24-VDC power supply connected to the AK-4 must be shared with the PIO interface.
- * Keep the length of the cable connecting the pulse output unit (PLC) and AK-04/JM-08 as short as possible. Also keep the cable between the AK-04/JM-08 and PULSE connector to 2m or less.

Note

Use the same power supply for open collector input/output to/from the host and for the AK-04, JM-08.

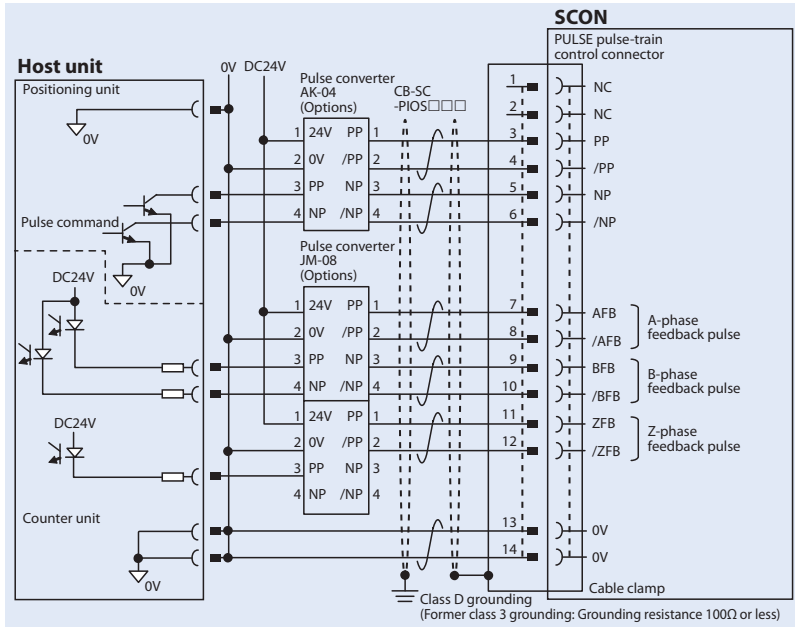

Command Pulse Input Patterns

Command pulse train pattern		Input terminal	Forward	Reverse	
Negative logic	Forward pulse-train	PP-/PP	[Pulse train diagram]	[Pulse train diagram]	
	Reverse pulse-train	NP-/NP	[Pulse train diagram]	[Pulse train diagram]	
	A forward pulse-train indicates the amount of motor rotation in the forward direction, while a reverse pulse-train indicates the amount of motor rotation in the reverse direction.				
	Pulse-train	PP-/PP	[Pulse train diagram]	[Pulse train diagram]	
	Sign	NP-/NP	Low	High	
	The command pulse is used for the amount of motor rotation, while the sign indicates the rotating direction.				
Positive logic	Phase A/B pulse-train	PP-/PP	[Pulse train diagram]	[Pulse train diagram]	
		NP-/NP	[Pulse train diagram]	[Pulse train diagram]	
	Command phases A and B having a 90° phase difference (multiplier is 4) indicate the amount of rotation and the rotating direction.				
	Forward pulse train	PP-/PP	[Pulse train diagram]	[Pulse train diagram]	
	Reverse pulse-train	NP-/NP	[Pulse train diagram]	[Pulse train diagram]	
Positive logic	Pulse-train	PP-/PP	[Pulse train diagram]	[Pulse train diagram]	
	Sign	NP-/NP	High	Low	
	Phase A/B pulse-train	PP-/PP	[Pulse train diagram]	[Pulse train diagram]	
	NP-/NP	[Pulse train diagram]	[Pulse train diagram]		

Specification Table		
Item	Specification	
Applicable motor capacity	Less than 400W	400W or more
Connected actuator	RCS2/RCS3 series actuator/single-axis robot/linear servo actuator	
Number of controlled axes	1 axis	
Operation method	Positioner type/pulse-train type	
Number of positioning points	512 points (PIO specification), 768 points (fieldbus specification)	
Backup memory	Nonvolatile memory (FRAM)	
I/O connector	40-pin connector	
Number of I/O points	16 input points/16 output points	
I/O power supply	Externally supplied 24VDC±10%	
Serial communication	RS485 1ch	
Peripherals communication cable	CB-PAC-PIO□□□□	
Command pulse-train input method (Note 1)	Differential line driver output supported	
Maximum input pulse frequency	Differential line driver method: 2.5Mpps max./Open-collector method (pulse converter used): 200kpps max.	
Position detection method	Incremental encoder/absolute encoder	
Emergency stop function	Available (built-in relay)	
Forced electromagnetic brake release	Brake release switch ON/OFF	
Input power supply	Single-phase AC90V to AC126.5V Single-phase AC180V to AC253V	Single-phase AC180V to AC253V
Power-supply capacity (Note 2)	20W/74VA 30W (other than RS)/94VA 30W (RS)/186VA 60W/186VA 100W/282VA 150W/376VA 200W/469VA	100W (LSA-N10)(*)/331VA 200W (LSA-S10H, N15S)(*)/534VA 200W (LSA-N15H)(*)/821VA 300W (LSA-N19)(*)/710VA 400W/968VA 600W/1212VA 750W/1569VA
Vibration resistance	XYZ directions – 10 to 57Hz: Single amplitude 0.035mm (continuous), 0.075mm (intermittent) 58 to 150Hz: 4.9 m/s ² (continuous), 9.8 m/s ² (intermittent)	
Ambient operating temperature	0 ~ 40°C	
Ambient operating humidity	85%RH or less (non-condensing)	
Operating ambience	Not exposed to corrosive gases	
Protection degree	IP20	
Mass	Approx. 900g (+ 25g for the absolute specification)	Approx. 1.2kg (+ 25g for the absolute specification)
External dimensions	58mm (W) x 194mm (H) x 121mm (D)	72mm (W) x 194mm (H) x 121mm (D)

(Note 1) For the command pulse input method, use the differential line driver method resistant to noise. If the open-collector method must be used, use the optional pulse converter (AK-04/JM-08) to convert open-collector pulses to differential pulses.

(Note 2) Controllers operating any of the actuator models denoted by (*) shall conform to the external dimensions of controllers for 400 W or more, even when the output is less than 400W.

External dimensions

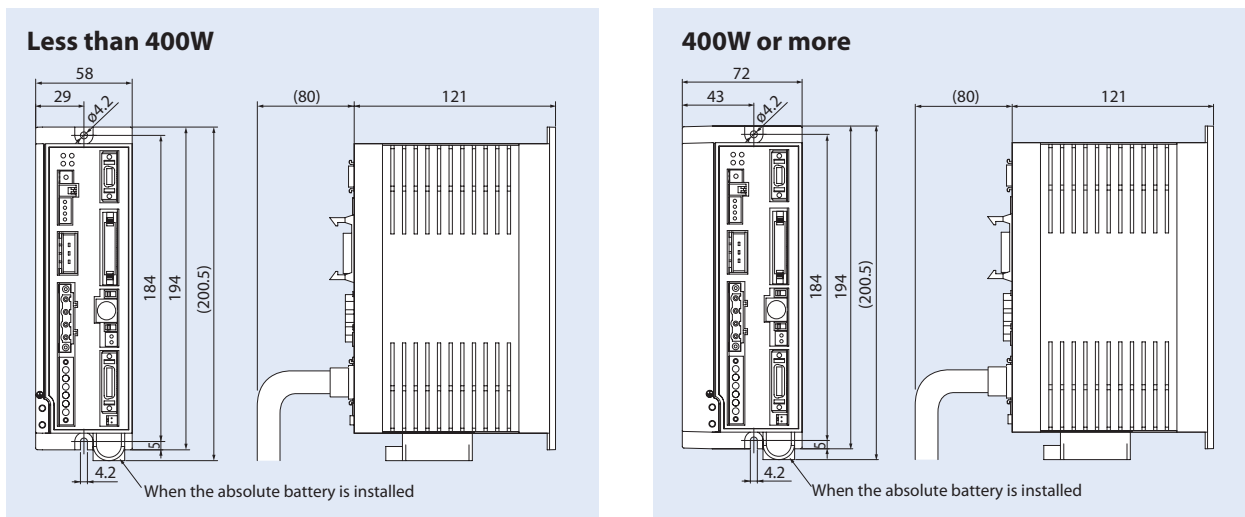

Options

Teaching Pendant

- Features** This teaching device offers position input, test operation, monitoring and other functions.
- Model** **CON-PTA-C** (Touch panel teaching pendant)
CON-T-ENG (Standard Type teaching pendant)
- Configuration**

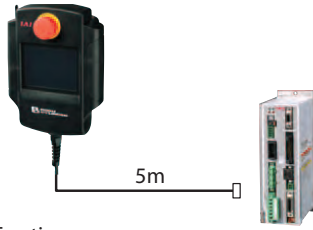

- CON-T options**
 - Wall-mounting hook
Model: **HK-1**



CON-PTA-C

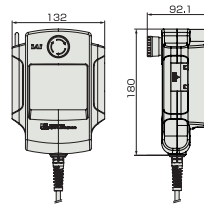

CON-T-ENG

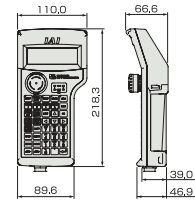

Specification

Item	CON-PTA-C	CON-T-ENG
Data input	○	○
Actuator operation	○	○
Ambient operating temperature/humidity	Temperature 0 to 40oC, humidity 85%RH or less	
Operating ambience	Free from corrosive gases or significant powder dust	
Protection degree	IP40	IP54
Mass	Approx. 570g	Approx. 400g
Cable length	5m	
Display	65,536 colors White LED backlight	20 characters x 4 lines LCD display
Standard price	—	—

PC Software (Windows Only)

- Features** This startup support software provides functions to input positions, perform test operations and monitor data, among others. Incorporating all functions needed to make adjustments, this software helps shorten the initial startup time.
- Model number** **RCM-101-MW** (With external device communication cable + RS232 conversion unit)
- Configuration** Offboard tuning is supported only in Ver. 8.05.00.00 or later.

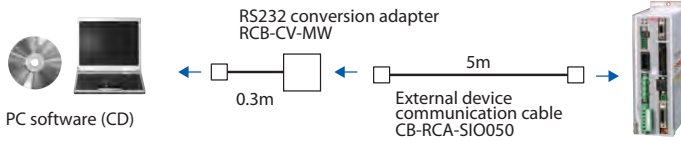

- Model number** **RCM-101-USB** (With external device communication cable + USB adapter + USB cable)
- Configuration** Offboard tuning is supported only in Ver. 8.05.00.00 or later.

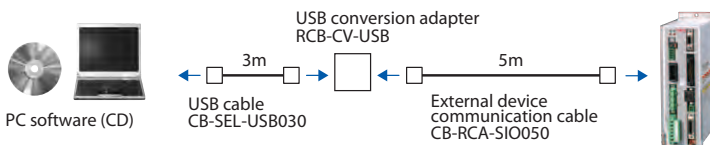

Regenerative Resistance Unit

- Features** This unit converts regenerative current that generates when the motor decelerates, to heat. Check the total wattage of the actuators to be operated and provide a regenerative resistance unit or units if required.
- Model** **REU-2** (for SCON/SSEL)

* If two regenerative units are required, arrange one REU-2 and one REU-1.

Specification

Unit mass	0.9Kg
Built-in regenerative resistor	220Ω 80W
Unit-controller connection cable (supplied)	CB-SC-REU010 (for SSEL)

Guide for Required Quantity

	Horizontal	Vertical
0 unit	~ 100W	~ 100W
1 unit	~ 400W	~ 400W
2 unit	~ 750W	~ 750W

* The required regenerative resistance may be more than as specified above depending on the operating conditions.

Guide for Required Quantity (RCS2-RA13R only)

	Lead 2.5	Lead 1.25
Horizontal	1 unit	0 unit
Vertical	1 unit	1 unit

* The required regenerative resistance may be more than as specified above depending on the operating conditions.

External Dimensions

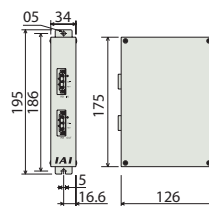

Absolute Data Backup Battery

- Features** Absolute data backup battery used when an actuator of absolute specification is operated.

Model number

AB-5



Spare parts

When you need spare parts after purchasing the product, such as when replacing a cable, refer to the list of models below.

Motor cable/Motor robot cable

Model **CB-RCC-MA** / **CB-RCC-MA** -**RB**

* Enter the cable length (L) into . Compatible to a maximum of 30 meters. Ex.: 080 = 8 m

Min. bend radius $r = 50$ mm or larger
(when movable type is used)
* Only the robot cable is to be used in a cable track.

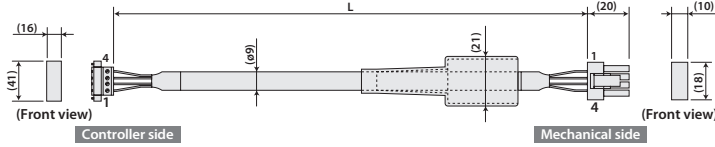

Wire	Color	Signal	Pin No.	Pin No.	Signal	Color	Wire
0.75sq	Green	PE	1	1	U	Red	0.75sq (crimped)
	Red	U	2	2	V	White	
	White	V	3	3	W	Black	
	Black	W	4	4	PE	Green	

Encoder cable/Encoder robot cable

Model **CB-RCS2-PA** / **CB-X3-PA**

* Enter the cable length (L) into . Compatible to a maximum of 30 meters. Ex.: 080 = 8 m

Min. bend radius $r = 50$ mm or larger
(when movable type is used)
* Only robot cable is to be used in a cable track.

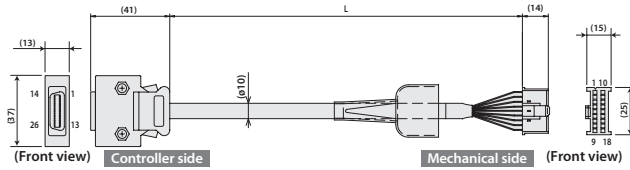

Wire	Color	Signal	Pin No.	Pin No.	Signal	Color	Wire
AWG26 (soldered)	Purple	A-	1	1	A	Purple	AWG26 (crimped)
	White	A	2	2	B	White	
	Blue/red	B-	3	3	B	Blue/red	
	Brown/white	B	4	4	B	Black	
	Brown/white	Z-	5	5	Z	Orange/white	
	Green/white	Z	6	6	Z	Green/white	
	Blue	SR+	7	7	SR	Blue	
	Orange	SR-	8	8	SR	Orange	
	Black	BAT+	14	14	BAT	Black	
	Yellow	BAT-	15	15	BAT	Yellow	
	Green	VCC	16	16	VCC	Green	
	Brown	GND	17	17	GND	Brown	
	Gray	BR+	20	20	BR	Gray	
	Red	BR-	21	21	BR	Red	
			22	22			
			18	18	BL+	Gray	
			18	18	BL-	Red	

I/O Flat Cable

Model **CB-PAC-PIO**

* Enter the cable length (L) into . Compatible to a maximum of 10 meters. Ex.: 080 = 8 m

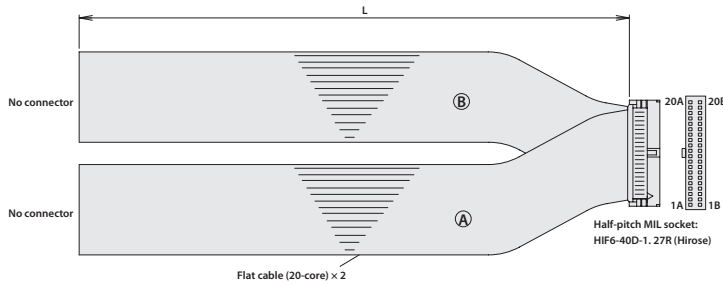

Pin No.	Signal	Color	Wire	Pin No.	Signal	Color	Wire
1A	24V	Brown-1	Flat cable (A) (crimped)	1B	OUT0	Brown-3	Flat cable (B) (crimped) AWG28
2A	24V	Red-1		2B	OUT1	Red-3	
3A	-	Orange-1		3B	OUT2	Orange-3	
4A	-	Yellow-1		4B	OUT3	Yellow-3	
5A	IN0	Green-1		5B	OUT4	Green-3	
6A	IN1	Blue-1		6B	OUT5	Blue-3	
7A	IN2	Purple-1		7B	OUT6	Purple-3	
8A	IN3	Gray-1		8B	OUT7	Gray-3	
9A	IN4	White-1		9B	OUT8	White-3	
10A	IN5	Black-1		10B	OUT9	Black-3	
11A	IN6	Brown-2		11B	OUT10	Brown-4	
12A	IN7	Red-2		12B	OUT11	Red-4	
13A	IN8	Orange-2		13B	OUT12	Orange-4	
14A	IN9	Yellow-2		14B	OUT13	Yellow-4	
15A	IN10	Green-2		15B	OUT14	Green-4	
16A	IN11	Blue-2		16B	OUT15	Blue-4	
17A	IN12	Purple-2		17B	-	Purple-4	
18A	IN13	Gray-2		18B	-	Gray-4	
19A	IN14	White-2		19B	OV	White-4	
20A	IN15	Black-2		20B	OV	Black-4	

SCON Pulse-Train Control Cable

Model **CB-SC-PIOS**

* Enter the cable length (L) into . Compatible to a maximum of 10 meters. Ex.: 080 = 8 m

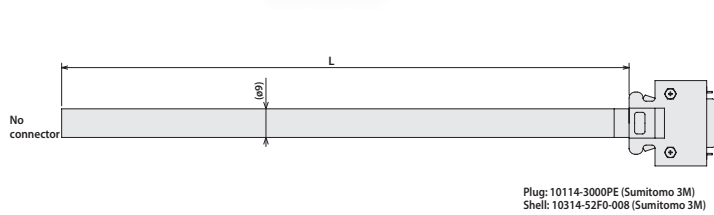

Wire	Color	Signal	Pin No.
Black	Black	Not used	1
White/Black	White/Black	Not used	2
Red	Red	PP	3
White/Red	White/Red	/PP	4
Green	Green	NP	5
White/Green	White/Green	/NP	6
Yellow	Yellow	AFB	7
White/Yellow	White/Yellow	/AFB	8
Brown	BFB	BFB	9
White/Brown	White/Brown	/BFB	10
Blue	ZFB	ZFB	11
White/Blue	White/Blue	/ZFB	12
Gray	GND	GND	13
White/Gray	White/Gray	GND	14
Shield	Shield	The shield is connected to a cable clamp.	