

ISPA/ICSPA ISA/ICSA

SINGLE-AXIS ROBOT/CARTESIAN ROBOT

Integrated System & Integrated System Precision

**New XY Configurations
Added**



Sold & Serviced By:

 **ELECTROMATE**

Toll Free Phone (877) SERV098

Toll Free Fax (877) SERV099

www.electromate.com







sales@electromate.com

VISUAL INDEX

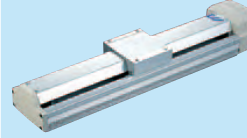
Single-Axis Robots

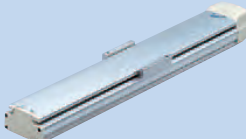
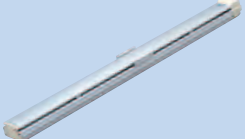
High-precision positioning systems with a linear positioning repeatability of 0.01 to 0.02 mm

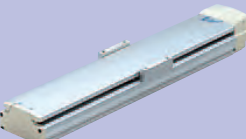
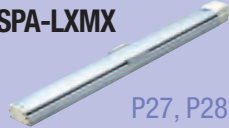
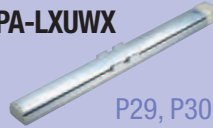

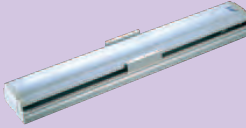
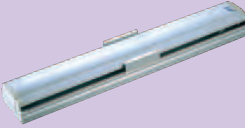
	X-Axis		Y-Axis	Z-Axis
	Standard Type	Mid-Support Type		
Compact Actuator width 90mm	ISA-SXM ISPA-SXM  P15	(Not available)	ISA-SYM ISPA-SYM  P16	ISA-SZM ISPA-SZM  P17
	ISA-MXM ISPA-MXM  P18, P19	ISA-MXMX ISPA-MXMX  P20	ISA-MYM ISPA-MYM  P21, P22	ISA-MZM ISPA-MZM  P23, P24
	ISA-LXM ISPA-LXM  P25, P26	ISA-LXMX ISPA-LXMX  P27, P28 ISA-LXUWX ISPA-LXUWX  P29, P30	ISA-LYM ISPA-LYM  P31, P32	ISA-LZM ISPA-LZM  P33, P34
	ISA-WXM ISPA-WXM  P35, P36	ISA-WXMX ISPA-WXMX  P37, P38	(Not available)	(Not available)

Point

The ISA/ICSA2 is a standard actuator with a positioning repeatability of ± 0.02 mm.
 The ISPA/ICSPA2 is a high-precision actuator with a positioning repeatability of ± 0.01 mm.

INDEX

Cartesian Robots

Transfer/positioning systems combining single-axis robots into a two to three orthogonal axes configuration.



<p>Y-Axis Base Mount</p> <p>The Y-axis slider moves horizontally.</p> <p>ICSA2-B □□□□ ICSPA2-B □□□□</p>  <p>P67-102</p>	<p>Y-Axis Slider Mount</p> <p>The entire Y-axis moves horizontally.</p> <p>ICSA2-S □□□□ ICSPA2-S □□□□</p>  <p>P103-114</p>	
<p>Z-Axis Base Mount</p> <p>The Z-axis is positioned vertically and mounted to the X-axis. The Z-axis slider moves vertically.</p> <p>ICSA2-Z □□□□ ICSPA2-Z □□□□</p>  <p>P115-130</p>	<p>Z-Axis Slider Mount</p> <p>The Z-axis slider is mounted to the Y-axis positioned on its side. The entire Z-axis moves vertically.</p> <p>ICSA2-Y □□□□ ICSPA2-Y □□□□</p>  <p>P131-140</p>	<p>Gantry</p> <p>A support axis is added in parallel with the X-axis and the Y-axis base is mounted to the sliders on the two axes. The Y-axis slider moves horizontally.</p> <p>ICSA2-G □□□□ ICSPA2-G □□□□</p>  <p>P141-144</p>

Controllers

Single-axis or Cartesian robot controllers that can execute various positioner operations and pulse-input program operations depending on your specific control needs.

<p>Single-Axis Position Controller</p> <p>SCON</p> 	<p>2-Axis Program Controller</p> <p>SSEL</p> 	<p>High-Function Multi-Axis Controller</p> <p>X-SEL</p> 
---	---	---

Overall Contents 2

Single-Axis Robot Series

Contents 4

Features 5

Specification Table 7

System Configurations 8

Points to Note 9

Explanation of Model Specification Items 11

Explanation of Options 13

Product Specifications 15

Technical Data 39

Cartesian Robot Series

Contents 42

Features 43

Product Types 45

Two-Axes Configuration Unit Selection Table 47

Three-Axes Configuration Unit Selection Table 49

Points to Note 59

Explanation of Model Specification Items 61

Product Specifications 63

System Configuration 65

Technical Data 241



Quality and Innovation



Single-Axis Robots

ISA
ISPA

Contents

■ Contents	4
■ Features	5
■ Specification Table	7
■ System Configurations	8
■ Points to Note	9
■ Explanation of Model Specification Items	11
■ Explanation of Options	13

3 ISPA/ICSPA Catalog

Sold & Serviced By:
 **ELECTROMATE**

Toll Free Phone (877) SERV098
Toll Free Fax (877) SERV099
www.electromate.com
sales@electromate.com

Single-Axis Robot Series **Contents**

Compact Actuator width 90mm	X-Axis	ISA (ISPA)-SXM	15	
	Y-Axis	ISA(ISPA)-SYM	16	
	Z (Vertical) Axis	ISA(ISPA)-SZM	17	
Medium Actuator width 120mm	X-Axis	ISA(ISPA)-MXM-100	18	
		ISA(ISPA)-MXM-200	19	
		Long-Stroke Type (Mid-Support Type) ISA(ISPA)-MXMX	20	
	Y-Axis	ISA(ISPA)-MYM-100	21	
		ISA(ISPA)-MYM-200	22	
	Z (Vertical) Axis	ISA(ISPA)-MZM-100	23	
		ISA(ISPA)-MZM-200	24	
	Large Actuator width 150mm	X-Axis	ISA(ISPA)-LXM-200	25
ISA(ISPA)-LXM-400			26	
Long-Stroke Type (Mid-Support Type)			ISA(ISPA)-LXMX-200	27
			ISA(ISPA)-LXMX-400	28
ISA(ISPA)-LXUWX-200			29	
ISA(ISPA)-LXUWX-400			30	
Y-Axis		ISA(ISPA)-LYM-200	31	
		ISA(ISPA)-LYM-400	32	
Z (Vertical) Axis		ISA(ISPA)-LZM-200	33	
		ISA(ISPA)-LZM-400	34	
Super Large Actuator width 198mm		X-Axis	ISA(ISPA)-WXM-600	35
	ISA(ISPA)-WXM-750		36	
	Long-Stroke Type (Mid-Support Type)	ISA(ISPA)-WXM-600	37	
		ISA(ISPA)-WXM-750	38	

Single-Axis Robot ISA/ISPA Series Features

The ISA/ISPA is a high-precision positioning system comprised of a base, linear guides, ball screw and AC servo motor. It achieves cost savings, because its design is more comprehensive and adjustment is much easier than when individual components are purchased and assembled.

1 Higher Maximum Acceleration/Deceleration of 1 G (9800 mm/sec²)

Both the ISA and ISPA achieve a maximum acceleration/ deceleration of 1 G, which was heretofore possible only with the ISP Series.

* When accelerating to 2000 mm/sec, a robot operating at an acceleration of 1 G achieves the target speed approx. 0.5 second faster than a robot operating at an acceleration of 0.3 G (as shown in the graph at right).

Acceleration/deceleration indicates the rate of change of speed. 1 G is equivalent to 9800 mm/sec², or the ability to accelerate (or decelerate) 9800 mm/sec per second.

■ Comparison of Acceleration Time at 1 G and 0.3 G

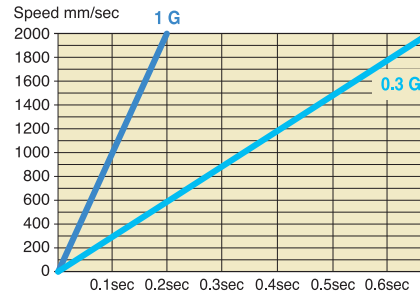

2 Dedicated X/Y/Z-Axes

Dedicated axes are available to choose from according to your specific need.

X-Axis Type (SXM, MXM, LXM, etc.)

- A dedicated cover prevents intrusion of small parts and other foreign objects from above.
- To install the actuator, open the cover and affix with bolts from above.



Y-Axis Type (SYM, MYM, LYM, etc.)

- A cover shape is adopted to prevent intrusion of small parts and other foreign objects from above when the actuator is installed on its side.

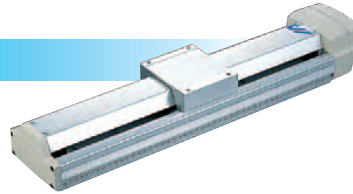

Z-Axis Type (SZM, MZM, LZM, etc.)

- The actuator comes standard with a slider anti-drop brake by assuming use in a vertical application.
- The mounting holes provided in the back of the base (actuator-mounting surface) are different from the mounting holes of the X-axis type.

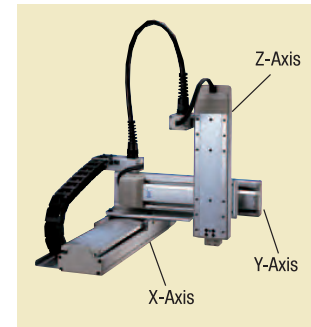
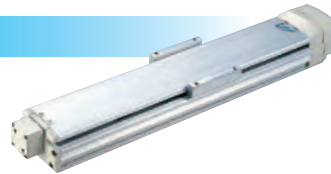

(A load can be attached easily to the base surface when the slider is mounted and the actuator is moved vertically.)

3 Achieving Higher Rigidity with Smaller Size via Base-Integrated Guide Structure

The thickness of the actuator has been reduced by embedding the guide rails in the base, eliminating the need for attachment of commercial guides. The base also employs a hollow box structure for improved rigidity.

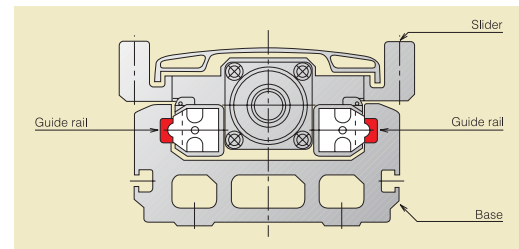

5 ISPA/ICSPA Catalog

Sold & Serviced By:
ELECTROMATE

Toll Free Phone (877) SERV098
Toll Free Fax (877) SERV099
www.electromate.com
sales@electromate.com

4 2500-mm Stroke with Ball Screw, Achieved with Mid-Support Mechanism

A ball screw drive actuator is prone to screw deflection when the stroke is increased, which makes it difficult to increase the rotating speed and therefore the actuator speed. As a result, belt drive has been the mainstream drive mechanism for long-stroke actuators.

The ISA/ISPA Series achieves a long stroke of 2500 mm using a ball screw drive, employing an original (patented) mid-support mechanism.

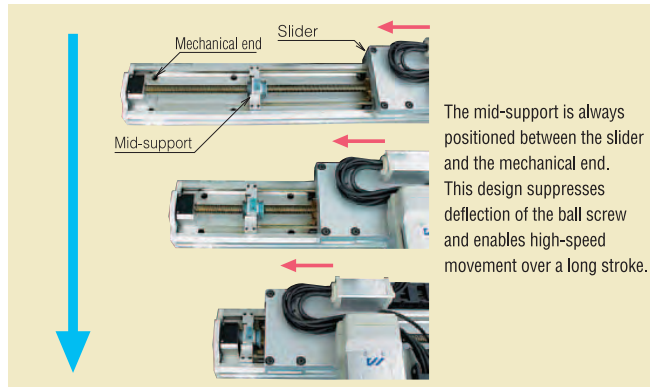
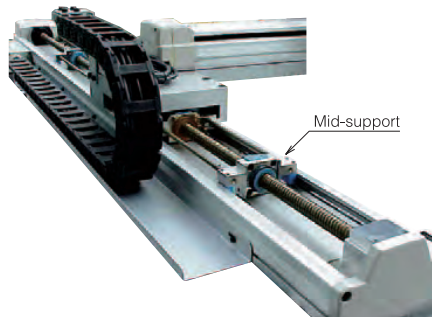

5 Direct Coupling Structure at Same Overall Length as Integrated Ball Screw/Rotor Type

The ISA/ISPA Series features a coupling structure of the same overall length as the conventional IS Series (integrated ball screw/rotor type). This structure allows for motor replacement in the event of a motor problem.

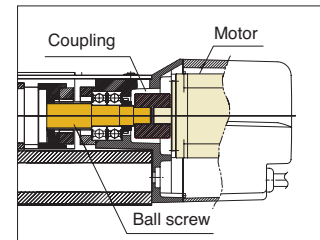

6 Selectable Controller Depending on Desired Control Method

The following three controller types are available:

1	2	3
Program operation	Single-Axis Position Controller	2-Axis Program Controller
Super SEL Controller X-SEL 	SCON 	SSEL 

Single-Axis Robot Series Specification Table

ISA ISPA	Stroke (mm), maximum speed (mm/sec) (Note 1)																									Load capacity (Note 2)		Motor capacity (W)	Lead (mm)	Model	Page	
	100	200	300	400	500	600	700	800	900	1000	1100	1200	1300	1400	1500	1600	1700	1800	1900	2000	2100	2200	2300	2400	2500	Horizontal (kg)	Vertical (kg)					
		800																									12	3	60	16	ISA(ISPA)-SXM-□-60-16-***	P15
	400																									25	6	8		ISA(ISPA)-SXM-□-60-8-***		
	200																									50	14	4		ISA(ISPA)-SXM-□-60-4-***		
	800																										12	3	60	16	ISA(ISPA)-SYM-□-60-16-***	P16
	400																									25	6	8		ISA(ISPA)-SYM-□-60-8-***		
	200																									50	14	4		ISA(ISPA)-SYM-□-60-4-***		
	400																										-	6	60	8	ISA(ISPA)-SZM-□-60-8-***-B	P17
	200																									-	14	4		ISA(ISPA)-SZM-□-60-4-***-B		
	1000					1000	795	645	540																		20	5	100	20	ISA(ISPA)-MXM-□-100-20-***	P18
	500					490	380	310	255																	40	9	10		ISA(ISPA)-MXM-□-100-10-***		
	250					220	175	145	120																	80	19	5		ISA(ISPA)-MXM-□-100-5-***		
	1500					1500	1190	965	810																		25	6	200	30	ISA(ISPA)-MXM-□-200-30-***	P19
	1000					1000	795	645	540																	40	9	20		ISA(ISPA)-MXM-□-200-20-***		
	500					490	380	310	255																	80	19	10		ISA(ISPA)-MXM-□-200-10-***		
							1500			1425	1200	1050	900	825	750	675											25	-	200	30	ISA(ISPA)-MXMX-□-200-30-***	P20
							1000			950	800	700	600	550	500	450										40	-	20		ISA(ISPA)-MXMX-□-200-20-***		
	1000					1000	795	645	540																		20	5	100	20	ISA(ISPA)-MYM-□-100-20-***	P21
	500					490	380	310	255																	40	9	10		ISA(ISPA)-MYM-□-100-10-***		
	250					220	175	145	120																	80	19	5		ISA(ISPA)-MYM-□-100-5-***		
	1500					1500	1190	965	810																		25	6	200	30	ISA(ISPA)-MYM-□-200-30-***	P22
	1000					1000	795	645	540																	40	9	20		ISA(ISPA)-MYM-□-200-20-***		
	500					490	380	310	255																	80	19	10		ISA(ISPA)-MYM-□-200-10-***		
	500					490	380	310	255																		-	9	100	10	ISA(ISPA)-MZM-□-100-10-***-B	P23
	250					220	175	145	120																	-	19	5		ISA(ISPA)-MZM-□-100-5-***-B		
	500					490	380	310	255																		-	19	200	10	ISA(ISPA)-MZM-□-200-10-***-B	P24
	1000					1000	630	630	585	500																	40	9	200	20	ISA(ISPA)-LXM-□-200-20-***	P25
	500					470	385	320	270	235																80	19	10		ISA(ISPA)-LXM-□-200-10-***		
	2000					2000	1660	1380	1170	1000																	40	9	400	40	ISA(ISPA)-LXM-□-400-40-***	P26
	1000					630	630	585	500																	80	19	20		ISA(ISPA)-LXM-□-400-20-***		
							1000			950	830	740	650	590	540	490	440	410	370	340							40	-	200	20	ISA(ISPA)-LXMX-□-200-20-***	P27
							2000			1900	1660	1480	1300	1180	1080	990	880	820	740	680						40	-	40		ISA(ISPA)-LXMX-□-400-40-***		
							1000			950	830	740	650	590	540	490	440	410	370	340							80	-	200	20	ISA(ISPA)-LXMX-□-400-20-***	P28
							1000			950	830	740	650	590	540	490	440	410	370	340						40	-	20		ISA(ISPA)-LXUWX-□-200-20-***		
							2000			1900	1660	1480	1300	1180	1080	990	880	820	740	680							40	-	400	40	ISA(ISPA)-LXUWX-□-400-40-***	P29
							1000			950	830	740	650	590	540	490	440	410	370	340						80	-	20		ISA(ISPA)-LXUWX-□-400-20-***		
	1000					1000	630	630	585	500																	40	9	200	20	ISA(ISPA)-LYM-□-200-20-***	P31
	500					470	385	320	270	235																80	19	10		ISA(ISPA)-LYM-□-200-10-***		
	2000					2000	1660	1380	1170	1000																	40	9		40	ISA(ISPA)-LYM-□-400-40-***	
	1000					1000	630	630	585	500																	80	19	400	20	ISA(ISPA)-LYM-□-400-20-***	P32
	500					470	385	320	270	235																-	19	100		10	ISA(ISPA)-LZM-□-200-10-***-B	
	500					470	385	320	270	235																	-	39	400	10	ISA(ISPA)-LZM-□-400-10-***	P34
	2000					1670	1330	1170	1000	865																	60	14	600	40	ISA(ISPA)-WXM-□-600-40-***	P35
	1000					835	635	585	500	430																120	29	20		ISA(ISPA)-WXM-□-600-20-***		
	500					415	345	290	250	215																150	60	10		ISA(ISPA)-WXM-□-600-10-***		
	2000					1670	1330	1170	1000	865																	75	18	750	40	ISA(ISPA)-WXM-□-750-40-***	P36
	1000					835	635	585	500	430																150	37	20		ISA(ISPA)-WXM-□-750-20-***		
							2000			1955	1725	1530	1365	1225	1110	1005	915	840	770	710	655						60	-	600	40	ISA(ISPA)-WXXM-□-600-40-***	P37
							1000			980	860	765	680	610	555	500	455	420	385	355	325					120	-	20		ISA(ISPA)-WXXM-□-600-20-***		
							2000			1955	1725	1530	1365	1225	1110	1005											75	-	750	40	ISA(ISPA)-WXXM-□-750-40-***	P38
							1000			980	860	765	680	610	555	500										150	-	20		ISA(ISPA)-WXXM-□-750-20-***		

(Note 1) The figure in the elongated circle indicates the maximum speed for each stroke. (Note 2) The load capacity is based on actuator operation at the rated acceleration (refer to page 9).

7

ISPA/ICSPA Catalog

Single-Axis Robot Series System Configurations

Single-Axis Robots

Cartesian Robots

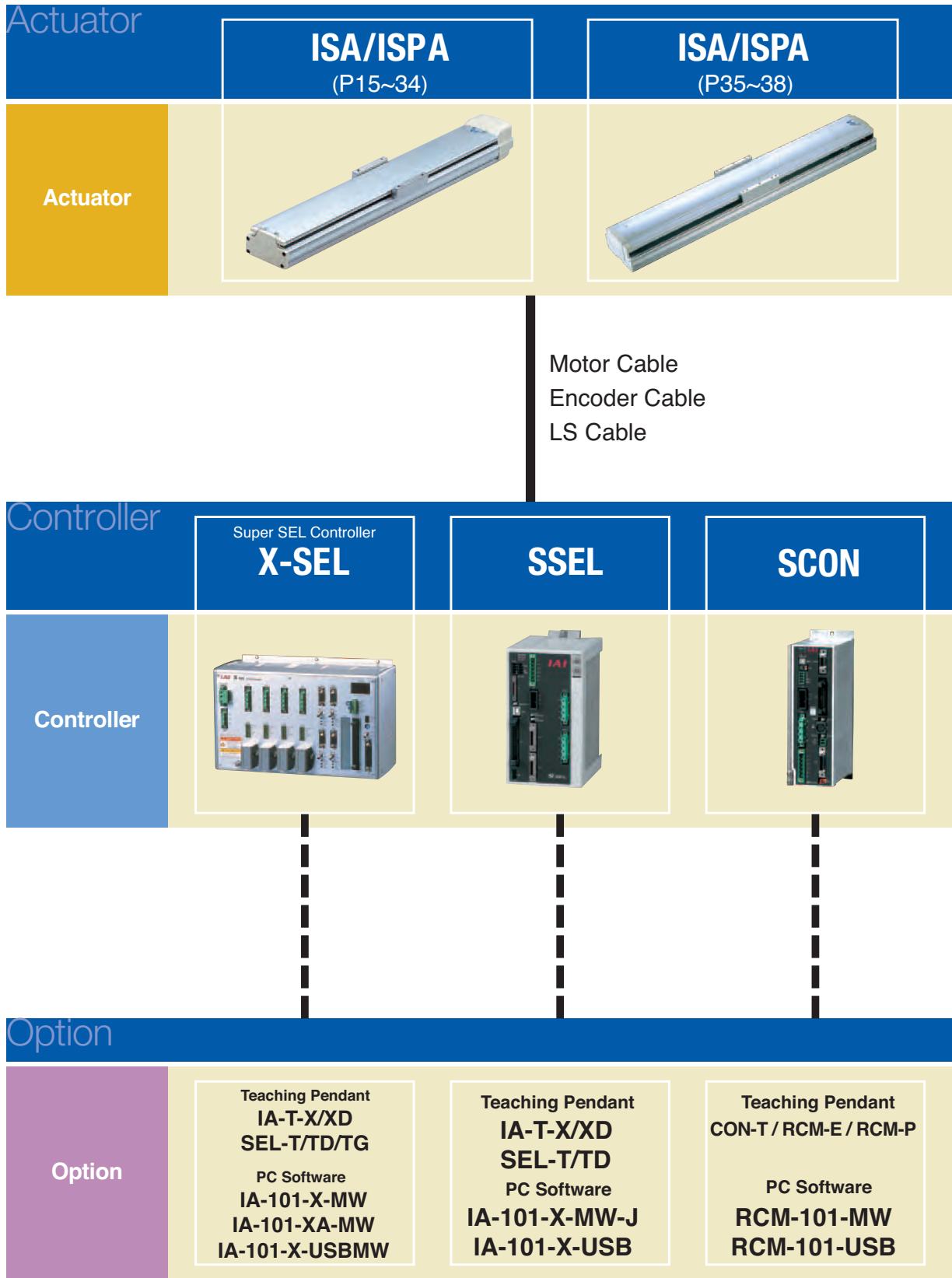

Notes on Catalog Specifications**Speed**

"Speed" refers to the specified speed at which the actuator slider will move.

The slider accelerates from a stationary state, and once the specified speed is reached it will maintain that speed until the specified position (immediately before the target position), where it will begin decelerating to stop at the target position.

< Caution >

- ① The maximum speed of the ISA/ISPA Series will remain the same even when the load placed on the slider is changed.
- ② The time needed to reach the specified speed will vary according to the acceleration (deceleration).
- ③ If the travel distance is short, the specified speed may not be reached.
- ④ With a long-stroke axis, the maximum speed will drop to avoid reaching a dangerous speed.
(If you are using a 600 or longer stroke, check the maximum speed for the applicable stroke in the corresponding dimensional drawing.)
- ⑤ When calculating the travel time, consider acceleration, deceleration and stabilization periods in addition to the travel time at the specified speed. (Refer to pages 39 and 40 for the method to calculate travel time.)
- ⑥ Speed can be set in increments of 1 mm/sec in a program.

Acceleration/Deceleration

"Acceleration" refers to the rate of change of speed when the speed rises from zero (stationary state) to the specified speed.

"Deceleration" refers to the rate of change of speed when the specified speed drops to zero (stationary state).

< Caution >

- ① Increasing the acceleration (deceleration) will shorten the duration the actuator accelerates (decelerates) and decrease the travel time. However, doing so will also cause rapid acceleration (deceleration), resulting in increased shock.
- ② The rated acceleration is 0.3 G (or 0.15 G if the lead is 4 or 5 mm.)
(The load capacity is set based on the rated acceleration.)
- ③ If the ISA/ISPA Series is operated at an acceleration (deceleration) exceeding the rated acceleration, the load capacity will drop.
(Refer to page 40 for details.)
- ④ Acceleration can be set in increments of 0.01 G in a program.

Duty

IAI recommends that our actuators be used at a duty of 50% or less as a guideline in view of the relationship of service life and accuracy.

$$\text{Duty (\%)} = \frac{\text{Acceleration / Deceleration Time}}{\text{Motion time} + \text{Inactivity}} \times 100$$

Positioning Repeatability

"Positioning repeatability" refers to the positioning accuracy of repeated movements to a pre-stored position.

This is not the same as **"absolute positioning accuracy,"** so exercise caution.

Positioning repeatability

Accuracy variation of the stop position when positioning is performed repeatedly to the same point.

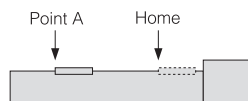
**Absolute positioning accuracy**

Difference between the coordinate value and the measured value when positioning is performed to a given positioning point specified by coordinates.

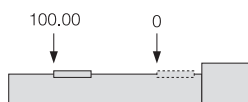

Notes on Catalog Specifications

Home

The home is set on the motor side for the standard specification, or on the counter-motor side for the reversed-home specification.

- The incremental actuator always requires homing every time the power is reconnected.
- During homing the slider will move to the mechanical end before reversing, so be careful to prevent contact with surrounding parts.
- To change the home direction, the actuator must be returned to IAI for adjustment.

Allowable Load Moments (Ma, Mb, Mc)

Each allowable load moment is calculated by assuming the service life of the guide as 10,000 km. Applying a moment exceeding the specified value will reduce the life of the guide, so exercise caution.

Directions of load moment for slider type

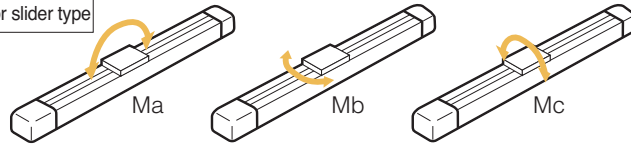

Overhung Load Length (L)

"Overhung load length" refers to a reference offset at which the actuator can operate smoothly when a load, bracket, etc., is installed at a position offset from the actuator/slider center.

When each model is used with an overhung load exceeding the allowable length, vibration or stabilization delay may result. Therefore, be sure to keep the overhung load length within the allowable value.

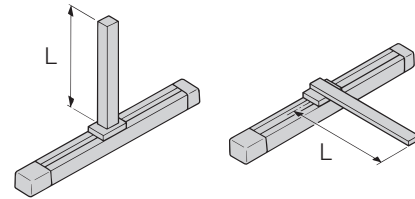

Actuator Accuracy

The accuracy of the ISA/ISPA-Series actuators is specified below.

The side and bottom faces of the actuator base provide reference surfaces for slider travel. Use them to adjust parallelism when installing the actuator.

Parallelism of actuator-mounting surface (bottom face of the base) and load-mounting surface (top face) 0.05 mm/m or less

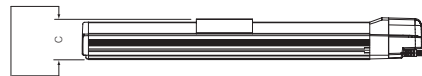

Parallelism when mounted on frame (when the actuator is mounted to a flat surface ¹⁾) 0.05 mm/m or less

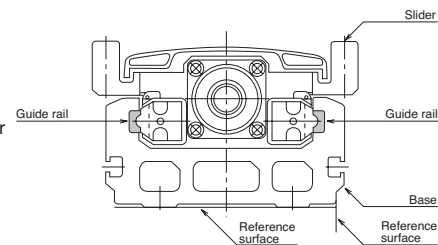
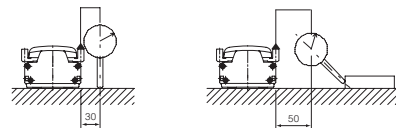

Condition: The above values are applicable at 20°C. ¹⁾ Flatness: 0.05 mm or less

Explanation of Model Specification Items

Refer to the right page for the explanation of each model specification item.

The selection range for each item will vary depending on the actuator type. For details, refer to the page corresponding to each actuator type.

(1)	(2)	(3)	(4)	(5)	(6)	(7)	(8)	(9)			
Series	Type	Encoder type	Motor output	Lead	Stroke	Applicable controller	Cable length	Options			
ISA ISPA	SXM SYM	A I	-	60	4 8 16	-	100 ~ 600	-	-		
	SZM				4 8						
	MXM MYM		-	100	-	5 10 20	-			-	-
			-	200	-	10 20 30					
	MZM		-	100	-	5 10	-			-	-
			-	200	-	10					
	MXMX		-	200	-	20 30	-			800 ~ 2000	-
	LXM LYM		-	200	-	10 20	-			100 ~ 1200	
			-	400	-	20 40					
	LZM		-	200	-	10	-			-	
			-	400	-	10					
	LXMX		-	200	-	20	-			1000 ~ 2500	
			-	400	-	20 40					
	LXUWX		-	200	-	20	-			-	
			-	400	-	20 40					
	WXM		-	600	-	10 20 40	-			100 ~ 1300	
			-	750	-	20 40					
	WXM X		-	600	-	20 40	-			900 ~ 2500	
			-	750	-	20 40					

AQ
B
C
CL
L
LL
LLM
LM
NM
RT
S

N
S
M
X□□

T1

(1) Series

Indicate the name of each series.

(2) Type

Indicate the classification by size (S, M, L or W), shape (X, Y or Z), etc.

(3) Encoder type

Indicate whether the encoder installed in the actuator is an "absolute type" or "incremental type."

- A: Absolute type Since the current slider position will be retained after the power is turned off, homing is not required when the actuator is powered up.
- I: Incremental type Since the slider position data are cleared when the power is turned off, homing must be performed every time the actuator is powered up.

(4) Motor output

Indicate the output of the motor installed in the actuator in watts.

(5) Lead

Indicate the ball screw lead.
"Lead" refers to the distance the slider will move when the ball screw rotates by one revolution.
The larger the lead, the faster the maximum speed becomes.

(6) Stroke

Indicate the actuator stroke (range of operation) in millimeters.

(7) Applicable controller

Indicate the type of controller that can be used with the actuator.
T1: X-SEL, E-Con, P-Driver

(8) Cable length

Indicate the length of the motor/encoder cable connecting the actuator and the controller.
N : No cable
S : 3m
M : 5m
X□□ : Use this field when a length other than 3 m and 5 m is specified.
(Example X08 : 8m)

* The standard cable is a robot cable.

(9) Actuator Accuracy

Indicate a desired option(s) to be equipped on the actuator. Refer to pages 13 and 14 for the explanation of each option.

* When selecting multiple options, specify them in alphabetical order (e.g., AQ-B-L-NM).

- AQ : [AQ seal] A unit that supplies lubricant to the sliding sections of the ball screw and guide.
- B : [Brake] A brake for preventing the slider from falling in a vertical application when the power or servo is turned off.
- C : [Creep sensor] A sensor for increasing the homing speed and thereby decreasing the homing time.
- CL : [Creep sensor on opposite side] The creep sensor is normally installed on the right side as viewed from the motor.
Select this option if you want to install the sensor on the left side.
- L : [Home limit switch] A limit switch for completing homing by reversing the slider using a sensor, not by the normal contact method, during homing.
- LL : [Home limit switch on opposite side] Similarly to the creep sensor on opposite side option, select this option if you want to install the limit switch on the opposite side.
- LM : [Master-axis designation] Specify this option for the axis to be used as the master in synchronized operation.
- LLM : [Master-axis limit switch on opposite side] Select this option if you want to install the limit switch on the opposite side of the master axis used in synchronized operation.
- NM : [Reverse-homing specification] Normally the home is set on the motor side. Select this option to specify the home on the counter-motor side.
- RT : [Guide with ball-retaining mechanism] A mechanism for reducing noise while extending the service life of the guide by inserting a spacer (retention device) between guide balls.
- S : [Slave-axis designation] Specify this option for the axis to be used as the slave in synchronized operation (limit switch is not required).

Options

AQ: [AQ seal]

The AQ seal is a lubrication unit that utilizes lubrication material made of resin-solidified lubricant.

The porous material impregnated with a large amount of lubricant allows lubricant to ooze out onto its surface via the capillary effect.

Lubricant is supplied when the AQ seal is pushed against the guide or ball-screw surface (steel-ball rolling surface). Combined use of the AQ seal and grease helps achieve maintenance-free operation for a long period.

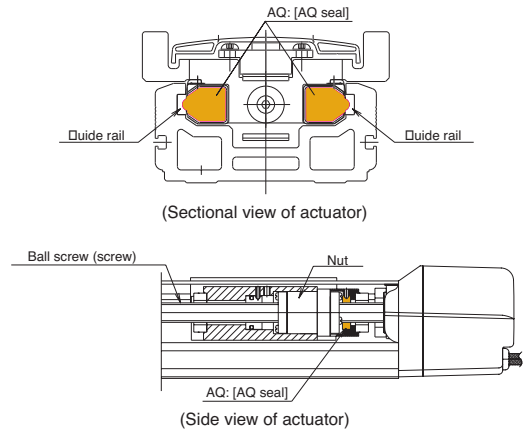

B: [Brake]

A retention mechanism that prevents the slider from falling and damaging the load when the power or servo is turned off in a vertical actuator application.

The S, M and L-type Z-axis actuators of the ISA/ISPA Series (SZM, MZM and LZM) are designed for use in a vertical application and therefore come standard with a brake.

If any axis other than the Z-axis is to be used vertically, install an optional brake.

For the S, M and L types, the brake is installed on the outside of the end cover on the counter-motor side (refer to the drawing of each model). The brake is installed inside the actuator only for the W type.

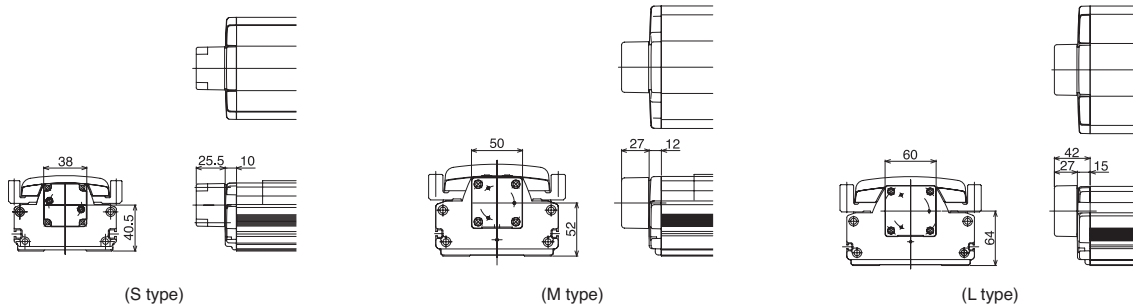

C: [Creep sensor]

A sensor used for achieving high-speed homing.

Normally during homing, the slider is caused to contact the stopper at the motor-side stroke end and then reverse, so the homing speed is kept to between 10 and 20 mm/s.

For this reason, it takes time to complete homing when the stroke is long. This proximity sensor reduces the homing time by allowing the slider to return at high speed and then reducing the speed to the normal homing speed just before homing is completed.

The standard installation position of this sensor is on the right side of the actuator as viewed from the motor (option code: C) (refer to the limit switch drawing on the right page).

A cover similar to that for the limit switch is provided on the outside of the sensor. To install the sensor on the opposite side, select CL (opposite side specification).

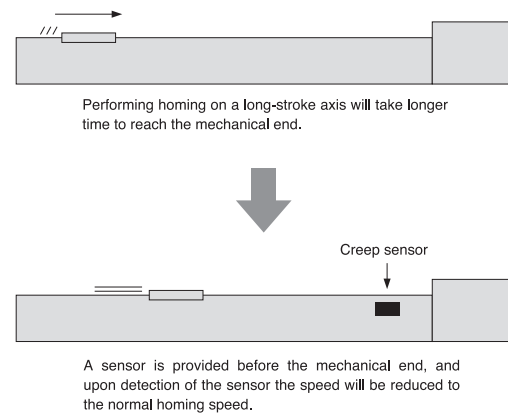

Options

LL: [Home limit switch on opposite side]

The normal homing operation of the ISA/ISPA Series conforms to the "contact method," whereby the slider is caused to contact the stopper and then reverse, after which the Z phase will be detected and set as the home.

Option L (home limit switch) achieves this homing operation by letting the slider reverse upon proximity sensor detection, without contacting the stopper. When this option is specified, three proximity sensors of HOME (for home detection), +OT (counter-motor side overtravel) and -OT (motor-side overtravel) will be installed. Use this option if you want to fine-tune the reversing position.

The standard installation position of the home limit switch and cover is on the right side of the actuator as viewed from the motor (option code: L).

To install the switch on the opposite side, select LL (opposite side specification).

*The ISP-W and ISPCR-W come standard with a limit switch. Since the limit switch is installed inside the actuator, no cover will be provided on the side face of the actuator (creep sensor is also housed in the actuator).

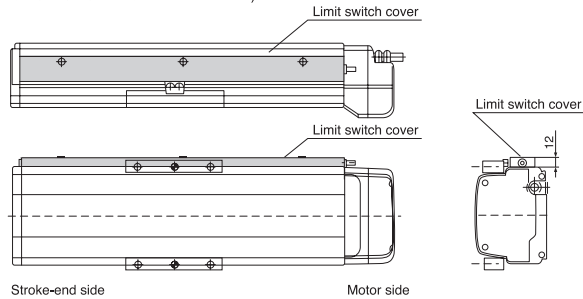

LM: [Master-axis designation in synchronized operation]

"Synchronized operation function" is one of the functions provided by the X-SEL controller.

It allows two actuator axes to operate simultaneously, with one axis acting as the master (option code: M) and the other as the slave (option code: S). The slave follows the master by super-high speed processing control to achieve simultaneous operation of the two axes. The two actuator axes used in synchronized operation must have the same specifications (type, lead motor output and stroke). When performing synchronized operation, the master axis must be of the limit switch specification. Therefore, specify LM (limit-switch master-axis designation) for the master axis and S (slave-axis designation) for the slave axis.

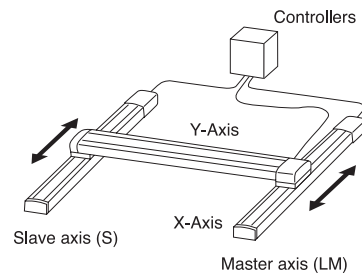

NM: [Reverse homing specification]

With the ISA/ISPA Series, the standard home direction is the motor side. To change the home direction, the encoder must be adjusted. If you prefer a reverse homing specification, specify it when placing an order.

RT: [Guide with ball-retaining mechanism]

A spacer (retainer) is inserted between guide balls (steel balls) to reduce noise while extending the service life of the guide.

The spacer eliminates annoying metal noise caused by colliding balls.

Since wear due to ball friction decreases, the service life of the guide will increase.

Elimination of ball contact will make the guide movement smoother, resulting in improved slider operability.

This option cannot be used with the ISP-WXM/WXMX.

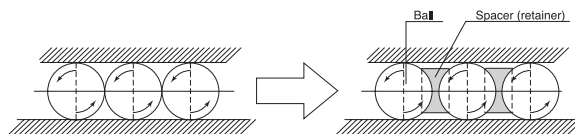
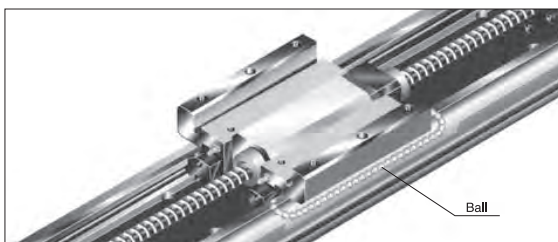

S: [Slave-axis designation in synchronized operation]

Specify this option for the axis to be used as the slave in synchronized operation. Refer to the explanation of LM (master-axis designation in synchronized operation) for details.

ISA-SXM Single-Axis Robot: Compact X-Axis Type, Actuator Width 90mm, 60W, Straight Shape
ISPA-SXM Single-Axis Robot: Compact X-Axis Type, Actuator Width 90mm, 60W, Straight Shape
 High-Precision Specification



Type	Compact X-axis (90-mm wide)	Stroke	100-600mm	Load capacity	50kg (horizontal)/14kg (vertical)
Model specification items: Series Type Encoder type Motor output Lead Stroke Applicable controller Cable length Options ISA[ISPA] - SXM - A - 60 - 16 - 600 - T1 - S - B					

* Refer to page 11 for the details of model specification items.

Models/Specifications

Model	Encoder type	Motor output (W)	Lead (mm)	Stroke (mm) In increments of 50mm (Note 1)	Speed (mm/s)	Acceleration (Note 2)				Load capacity (Note 2)				Rated thrust (N)
						Horizontal (G)		Vertical (G)		Horizontal (kg)		Vertical (kg)		
						Rated	Maximum	Rated	Maximum	Rated	Maximum	Rated	Maximum	
ISA [ISPA] -SXM-A-60-16-***-T1-Δ-□	Absolute	60	16	100~600	1~800	0.3	1.0	0.3	0.7	12	3.5	3	2	63.7
ISA [ISPA] -SXM-A-60-8-***-T1-Δ-□			8		1~400	0.3	0.6	0.3	0.5	25	12	6	5	127.4
ISA [ISPA] -SXM-A-60-4-***-T1-Δ-□			4		1~200	0.15	0.5	0.15	0.3	50	30	14	12	254.8
ISA [ISPA] -SXM-I-60-16-***-T1-Δ-□	Incremental	60	16	100~600	1~800	0.3	1.0	0.3	0.7	12	3.5	3	2	63.7
ISA [ISPA] -SXM-I-60-8-***-T1-Δ-□			8		1~400	0.3	0.6	0.3	0.5	25	12	6	5	127.4
ISA [ISPA] -SXM-I-60-4-***-T1-Δ-□			4		1~200	0.15	0.5	0.15	0.3	50	30	14	12	254.8

* In the above model names, *** indicates the stroke, Δ the cable length and □ the applicable options.

*1.0G=9800mm/sec²

Options

Name	Code	Page	Name	Code	Page
AQ seal	AQ	P13	Master-axis designation	LM	P14
Brake	B	P13	Master-axis designation (sensor on opposite side)	LLM	P14
Creep sensor	C	P13	Reverse homing specification	NM	P14
Creep sensor on opposite side	CL	P13	Guide with ball-retaining mechanism	RT	P14
Home limit switch	L	P14	Slave-axis designation	S	P14
Home limit switch on opposite side	LL	P14			

Common Specifications

* Refer to page 10 for the details of common specification items.

Positioning repeatability (Note 3)	±0.02mm [±0.01mm]
Drive system (Note 4)	Ball screw ø12mm, rolled C10 [equivalent to rolled C5]
Lost motion (Note 5)	0.05mm or less [0.02mm or less]
Guide	integrated with base
Allowable static moment	Refer to page 242
Allowable dynamic moment	Ma: 28.4N·m Mb: 40.2N·m Mc: 65.7N·m
Overhang load length	Ma direction: 450mm or less, Mb/Mc directions: 450mm or less
Base	Material: Aluminum, with white alumite treatment
Cable length (Note 6)	N: None, S: 3m, M: 5m, X□□: Specified length
Ambient operating temperature/humidity	0 to 40°C, 85%RH max. (non-condensing)

Dimensions

* Note that changing the home direction will require the actuator to be returned to IAI for adjustment.

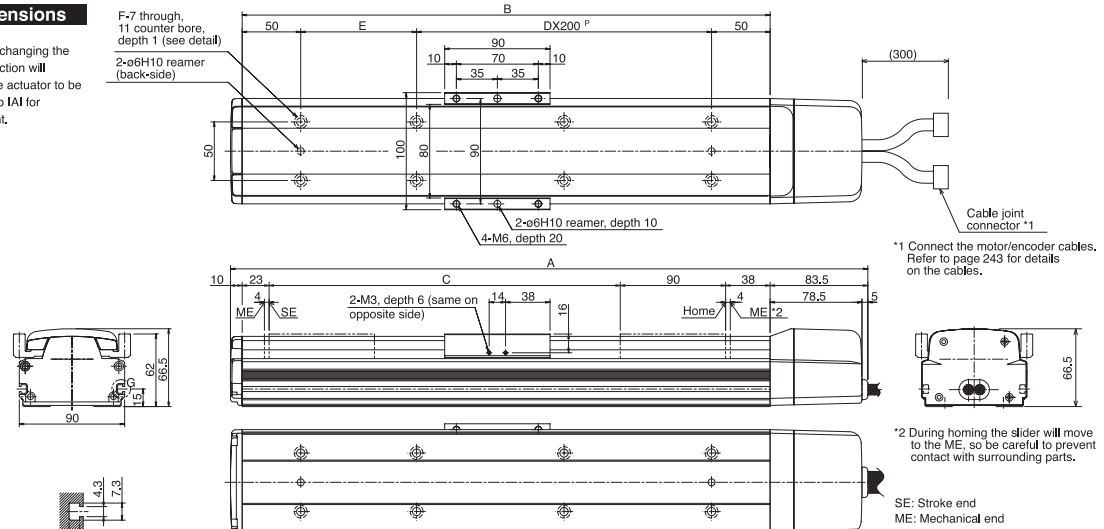

Dimensions, Weight and Maximum Speed by Stroke

Stroke	100	(150)	200	(250)	300	(350)	400	(450)	500	(550)	600
A	344.5	394.5	444.5	494.5	544.5	594.5	644.5	694.5	744.5	794.5	844.5
B	251	301	351	401	451	501	551	601	651	701	751
C	100	150	200	250	300	350	400	450	500	550	600
D	0	0	0	1	1	1	1	2	2	2	2
E	151	201	251	101	151	201	251	101	151	201	251
F	4	4	4	6	6	6	6	8	8	8	8
Weight (kg)	2.8	3.1	3.4	3.7	4.0	4.3	4.6	4.9	5.2	5.5	5.8
Maximum speed (mm/s)	Lead 16: 800 Lead 8: 400 Lead 4: 200										

Applicable Controller Specifications

Applicable controller	Maximum number of controlled axes	Compatible encoder type	Program operation	Positioner operation	Pulse-train control	Supply voltage	Page
X-SEL	4 axes	Absolute/incremental	○	△	×	AC100/200V	
E-Con	1 axis	Absolute/incremental	×	○	×	AC100/200V	
P-Driver	1 axis	Incremental	×	×	○	AC100/200V	

Caution

(Note 1) The strokes that are set in increments of 50 mm are semi-standard settings.
 (Note 2) Refer to page 40 for the relationship of acceleration and load capacity.
 (Notes 3, 4, 5) The figures in brackets apply to the ISPA Series.
 Other specification values apply to both the ISA and ISPA Series.
 (Note 6) The maximum cable length is 30 m. Specify the desired length in meters (e.g., X08 = 8 m).

* Refer to page 9 for other points to note.

ISA-SYM Single-Axis Robot: Compact Y-Axis Type, Actuator Width 90mm, 60W, Straight Shape
ISPA-SYM Single-Axis Robot: Compact Y-Axis Type, Actuator Width 90mm, 60W, Straight Shape
 High-Precision Specification

Type Compact Y-axis (90-mm wide) Stroke 100~600mm Load capacity 50kg (horizontal)/14kg (vertical)

Model specification items Series Type Encoder type Motor output Lead Stroke Applicable controller Cable length Options
 ISA[ISPA] - SYM - A - 60 - 16 - 600 - T1 - S - B

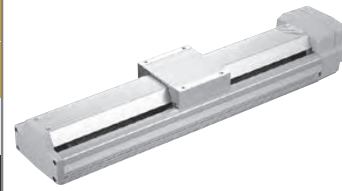

* Refer to page 11 for the details of model specification items.

Models/Specifications

Model	Encoder type	Motor output (W)	Lead (mm)	Stroke (mm) In increments of 50mm (Note 1)	Speed (mm/s)	Acceleration (Note 2)				Load capacity (Note 2)				Rated thrust (N)
						Horizontal (G)		Vertical (G)		Horizontal (kg)		Vertical (kg)		
						Rated	Maximum	Rated	Maximum	Rated	Maximum	Rated	Maximum	
ISA [ISPA] -SYM-A-60-16-***-T1-△-□	Absolute	60	16	100 ~ 600	1 ~ 800	0.3	1.0	0.3	0.7	12	3.5	3	2	63.7
ISA [ISPA] -SYM-A-60-8-***-T1-△-□			8		1 ~ 400	0.3	0.6	0.3	0.5	25	12	6	5	127.4
ISA [ISPA] -SYM-A-60-4-***-T1-△-□			4		1 ~ 200	0.15	0.5	0.15	0.3	50	30	14	12	254.8
ISA [ISPA] -SYM-I-60-16-***-T1-△-□	Incremental	60	16	100 ~ 600	1 ~ 800	0.3	1.0	0.3	0.7	12	3.5	3	2	63.7
ISA [ISPA] -SYM-I-60-8-***-T1-△-□			8		1 ~ 400	0.3	0.6	0.3	0.5	25	12	6	5	127.4
ISA [ISPA] -SYM-I-60-4-***-T1-△-□			4		1 ~ 200	0.15	0.5	0.15	0.3	50	30	14	12	254.8

* In the above model names, *** indicates the stroke, △ the cable length and □ the applicable options.

*1,0G=9800mm/sec²

Options

Name	Code	Page	Name	Code	Page
AQ seal	AQ	P13	Master-axis designation	LM	P14
Brake	B	P13	Master-axis designation (sensor on opposite side)	LLM	P14
Creep sensor	C	P13	Reverse homing specification	NM	P14
Creep sensor on opposite side	CL	P13	Guide with ball-retaining mechanism	RT	P14
Home limit switch	L	P14	Slave-axis designation	S	P14
Home limit switch on opposite side	LL	P14			

Common Specifications

* Refer to page 10 for the details of common specification items.

Positioning repeatability (Note 3)	±0.02mm [±0.01mm]
Drive system (Note 4)	Ball screw ø12mm, rolled C10 [equivalent to rolled C5]
Lost motion (Note 5)	0.05mm or less [0.02mm or less]
Guide	integrated with base
Allowable static moment	Refer to page 242
Allowable dynamic moment	Ma: 28.4N•m Mb: 40.2N•m Mc: 32.8N•m
Overhang load length	Ma direction: 450mm or less, Mb/Mc directions: 450mm or less
Base	Material: Aluminum, with white alumite treatment
Cable length (Note 6)	N: None, S: 3m, M: 5m, X□□: Specified length
Ambient operating temperature/humidity	0 to 40°C, 85%RH max. (non-condensing)

Dimensions

* Note that changing the home direction will require the actuator to be returned to |A| for adjustment.

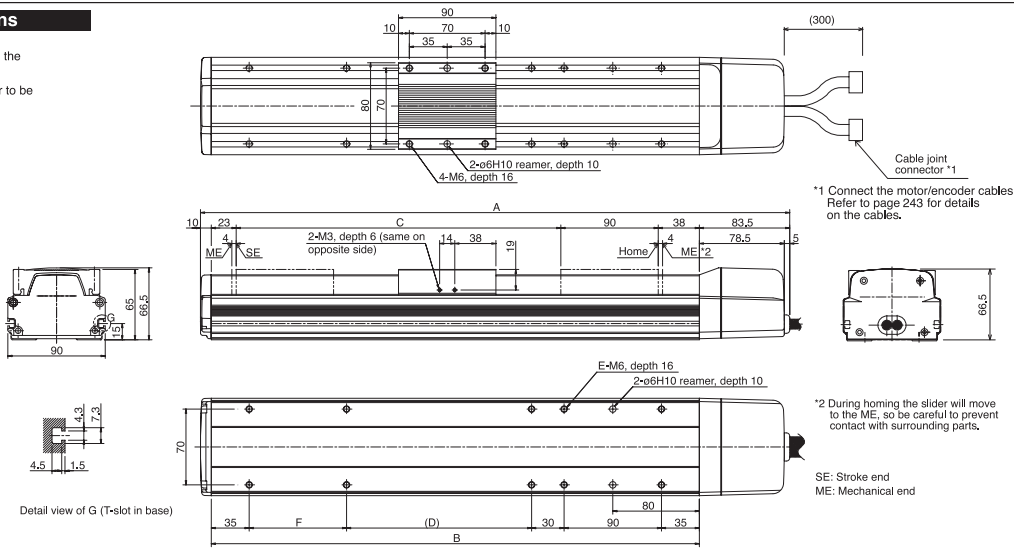

Dimensions, Weight and Maximum Speed by Stroke

Stroke	100	(150)	200	(250)	300	(350)	400	(450)	500	(550)	600
A	344.5	394.5	444.5	494.5	544.5	594.5	644.5	694.5	744.5	794.5	844.5
B	251	301	351	401	451	501	551	601	651	701	751
C	100	150	200	250	300	350	400	450	500	550	600
D	61	21	71	121	171	221	271	321	371	421	471
E	8	10	10	10	10	10	10	10	10	10	10
F	-	90	90	90	90	90	90	90	90	90	90
Weight (kg)	2,8	3,2	3,5	3,9	4,2	4,6	4,9	5,3	5,6	6,0	6,3
Maximum speed (mm/s)	Lead 16	800									
	Lead 8	400									
	Lead 4	200									

Applicable Controller Specifications

Applicable controller	Maximum number of controlled axes	Compatible encoder type	Program operation	Positioner operation	Pulse-train control	Supply voltage	Page
X-SEL	4 axes	Absolute/incremental	○	△	×	AC100/200V	
E-Con	1 axis	Absolute/incremental	×	○	×	AC100/200V	
P-Driver	1 axis	Incremental	×	×	○	AC100/200V	

Caution

(Note 1) The strokes that are set in increments of 50 mm are semi-standard settings.
 (Note 2) Refer to page 40 for the relationship of acceleration and load capacity.
 (Notes 3, 4, 5) The figures in brackets apply to the ISPA Series.
 Other specification values apply to both the ISA and ISPA Series.
 (Note 6) The maximum cable length is 30 m. Specify the desired length in meters (e.g., X08 = 8 m).

* Refer to page 9 for other points to note.

ISA-SZM Single-Axis Robot: Compact Vertical-Axis Type, Actuator Width 90mm, 60W, Straight Shape

ISPA-SZM Single-Axis Robot: Compact Vertical-Axis Type, Actuator Width 90mm, 60W, Straight Shape
High-Precision Specification

Type Compact vertical axis (90-mm wide) Stroke 100~600mm Vertical application only (with standard brake) 14kg

Model specification items Series Type Encoder type Motor output Lead Stroke Applicable controller Cable length Options
ISA[ISPA] - SZM - A - 60 - 16 - 600 - T1 - S - B - L



* Refer to page 11 for the details of model specification items.

Models/Specifications

Model	Encoder type	Motor output (W)	Lead (mm)	Stroke (mm) In increments of 50mm (Note 1)	Speed (mm/s)	Acceleration (Note 2)				Load capacity (Note 2)				Rated thrust (N)	
						Horizontal (G)		Vertical (G)		Horizontal (kg)		Vertical (kg)			
						Rated	Maximum	Rated	Maximum	Rated acceleration	Maximum acceleration	Rated acceleration	Maximum acceleration		
ISA [ISPA] -SZM-A-60-8-***-T1-△-B-□	Absolute	60	8	100 ~ 600	1 ~ 200	Vertical application only	0.3	0.5	Vertical application only	6	5	127.4			
ISA [ISPA] -SZM-A-60-4-***-T1-△-B-□			4		1 ~ 200								0.15	0.3	14
ISA [ISPA] -SZM-I-60-8-***-T1-△-B-□	8	1 ~ 400	0.3		0.5										
ISA [ISPA] -SZM-I-60-4-***-T1-△-B-□	4	1 ~ 200											0.15	0.3	14

* In the above model names, *** indicates the stroke, △ the cable length and □ the applicable options.

*1,0G=9800mm/sec²

Options

Name	Code	Page	Name	Code	Page
AQ seal	AQ	P13	Master-axis designation	LM	P14
Brake	B	P13	Master-axis designation (sensor on opposite side)	LLM	P14
Creep sensor	C	P13	Reverse homing specification	NM	P14
Creep sensor on opposite side	CL	P13	Guide with ball-retaining mechanism	RT	P14
Home limit switch	L	P14	Slave-axis designation	S	P14
Home limit switch on opposite side	LL	P14			

* The SZM type comes standard with a brake (B).

Common Specifications

* Refer to page 10 for the details of common specification items.

Positioning repeatability (Note 3)	±0.02mm [±0.01mm]
Drive system (Note 4)	Ball screw ø12mm, rolled C10 [equivalent to rolled C5]
Lost motion (Note 5)	0.05mm or less [0.02mm or less]
Guide	integrated with base
Allowable static moment	Refer to page 242
Allowable dynamic moment	Ma: 28.4N·m Mb: 40.2N·m Mc: 33.3N·m
Brake	Comes standard with a dry, single-plate, non-excitation type electromagnetic brake
Base	Material: Aluminum, with white alumite treatment
Cable length (Note 6)	N: None, S: 3m, M: 5m, X□□: Specified length
Ambient operating temperature/humidity	0 to 40°C, 85%RH max. (non-condensing)

Dimensions

* Note that changing the home direction will require the actuator to be returned to IAI for adjustment.

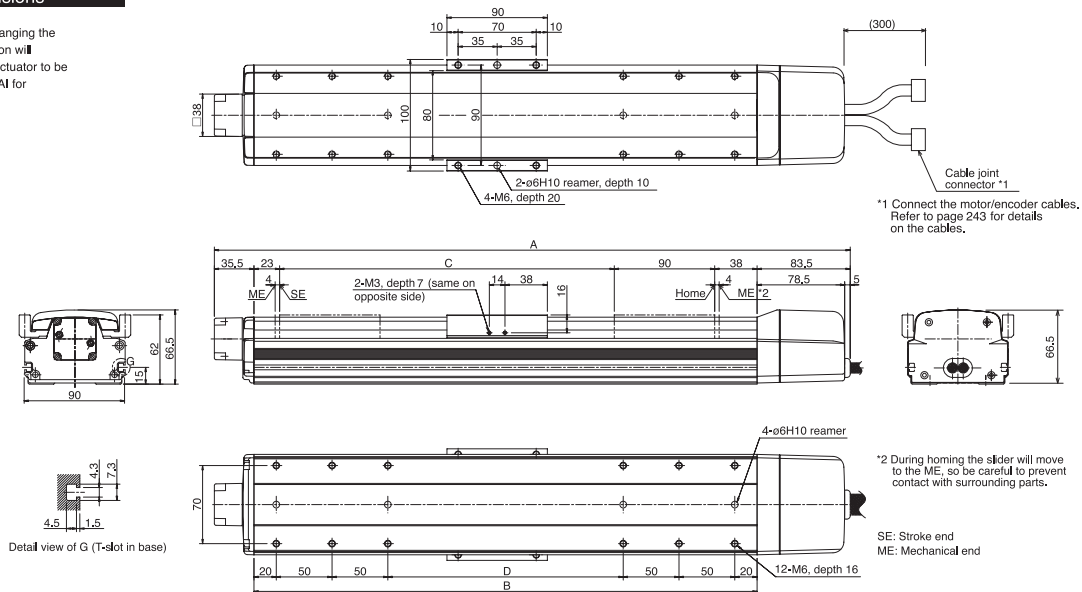

*1 Connect the motor/encoder cables. Refer to page 243 for details on the cables.

*2 During homing the slider will move to the ME, so be careful to prevent contact with surrounding parts.

SE: Stroke end
ME: Mechanical end

Dimensions, Weight and Maximum Speed by Stroke

Stroke	100	(150)	200	(250)	300	(350)	400	(450)	500	(550)	600	
A	370	420	470	520	570	620	670	720	770	820	870	
B	251	301	351	401	451	501	551	601	651	701	751	
C	100	150	200	250	300	350	400	450	500	550	600	
D	11	61	111	161	211	261	311	361	411	461	511	
Weight (kg)	3.0	3.4	3.7	4.1	4.4	4.8	5.1	5.5	5.8	6.2	6.5	
Maximum speed (mm/s)	400						200					
Lead 8												
Lead 4												

Applicable Controller Specifications

Applicable controller	Maximum number of controlled axes	Compatible encoder type	Program operation	Positioner operation	Pulse-train control	Supply voltage	Page
X-SEL	4 axes	Absolute/Incremental	○	△	×	AC100/200V	
E-Con	1 axis	Absolute/Incremental	×	○	×	AC100/200V	
P-Driver	1 axis	Incremental	×	×	○	AC100/200V	

*The SZM type comes standard with a brake, so use a controller of brake specification.

Caution

(Note 1) The strokes that are set in increments of 50 mm are semi-standard settings.
 (Note 2) Refer to page 40 for the relationship of acceleration and load capacity.
 (Notes 3, 4, 5) The figures in brackets apply to the ISPA Series.
 Other specification values apply to both the ISA and ISPA Series.
 (Note 6) The maximum cable length is 30 m. Specify the desired length in meters (e.g., X08 = 8 m).

* Refer to page 9 for other points to note.

ISA-MXM-200 Single-Axis Robot: Medium X-Axis Long Slider Type, Actuator Width 120mm, 200W, Straight Shape

ISPA-MXM-200 Single-Axis Robot: Medium X-Axis Long Slider Type, Actuator Width 120mm, 200W, Straight Shape **High-Precision Specification**

Type	Medium X-axis (120-mm wide) long slider type	Stroke	100 ~ 1000mm	Load capacity	80kg (horizontal)/19kg (vertical)																				
<table border="1"> <tr> <td>Model specification items</td> <td>Series</td> <td>Type</td> <td>Encoder type</td> <td>Motor output</td> <td>Lead</td> <td>Stroke</td> <td>Applicable controller</td> <td>Cable length</td> <td>Options</td> </tr> <tr> <td colspan="10">ISA[ISPA] - MXM - A - 200 - 30 - 1000 - T1 - S - B</td> </tr> </table>						Model specification items	Series	Type	Encoder type	Motor output	Lead	Stroke	Applicable controller	Cable length	Options	ISA[ISPA] - MXM - A - 200 - 30 - 1000 - T1 - S - B									
Model specification items	Series	Type	Encoder type	Motor output	Lead	Stroke	Applicable controller	Cable length	Options																
ISA[ISPA] - MXM - A - 200 - 30 - 1000 - T1 - S - B																									



* Refer to page 11 for the details of model specification items.

Models/Specifications

Model	Encoder type	Motor output (W)	Lead (mm)	Stroke (mm) In increments of 50mm (Note 1)	Speed (Note 2) (mm/s)	Acceleration (Note 3)				Load capacity (Note 3)				Rated thrust (N)
						Horizontal (G)		Vertical (G)		Horizontal (kg)		Vertical (kg)		
						Rated	Maximum	Rated	Maximum	Rated acceleration	Maximum acceleration	Rated acceleration	Maximum acceleration	
ISA [ISPA] -MXM-A-200-30-***-T1-△-□	Absolute	200	30	100 ~ 1000	1 ~ 1500	0.3	1.0	0.3	1.0	25	10	6	2	113
ISA [ISPA] -MXM-A-200-20-***-T1-△-□			20		1 ~ 1000	0.3	1.0	0.3	0.8	40	12	9	5	169.5
ISA [ISPA] -MXM-A-200-10-***-T1-△-□			10		1 ~ 500	0.3	0.6	0.3	0.5	80	40	19	15	340.1
ISA [ISPA] -MXM-I-200-30-***-T1-△-□	Incremental	200	30	100 ~ 1000	1 ~ 1500	0.3	1.0	0.3	1.0	25	10	6	2	113
ISA [ISPA] -MXM-I-200-20-***-T1-△-□			20		1 ~ 1000	0.3	1.0	0.3	0.8	40	12	9	5	169.5
ISA [ISPA] -MXM-I-200-10-***-T1-△-□			10		1 ~ 500	0.3	0.6	0.3	0.5	80	40	19	15	340.1

* In the above model names, *** indicates the stroke, △ the cable length and □ the applicable options.

*1,0G=9800mm/sec²

Options

Name	Code	Page	Name	Code	Page
AQ seal	AQ	P13	Master-axis designation	LM	P14
Brake	B	P13	Master-axis designation (sensor on opposite side)	LLM	P14
Creep sensor	C	P13	Reverse homing specification	NM	P14
Creep sensor on opposite side	CL	P13	Guide with ball-retaining mechanism	RT	P14
Home limit switch	L	P14	Slave-axis designation	S	P14
Home limit switch on opposite side	LL	P14			

Common Specifications

* Refer to page 10 for the details of common specification items.

Positioning repeatability (Note 4)	±0.02mm [±0.01mm]
Drive system (Note 5)	Ball screw ø16mm, rolled C10 [equivalent to rolled C5]
Lost motion (Note 6)	0.05mm or less [0.02mm or less]
Guide	integrated with base
Allowable static moment	Refer to page 242
Allowable dynamic moment	Ma: 69.6N•m Mb: 99.0N•m Mc: 161.7N•m
Overhang load length	Ma direction: 600mm or less, Mb/Mc directions: 600mm or less
Base	Material: Aluminum, with white alumite treatment
Cable length (Note 7)	N: None, S: 3m, M: 5m, X□□: Specified length
Ambient operating temperature/humidity	0 to 40°C, 85%RH max. (non-condensing)

Dimensions

* Note that changing the home direction will require the actuator to be returned to IAI for adjustment.

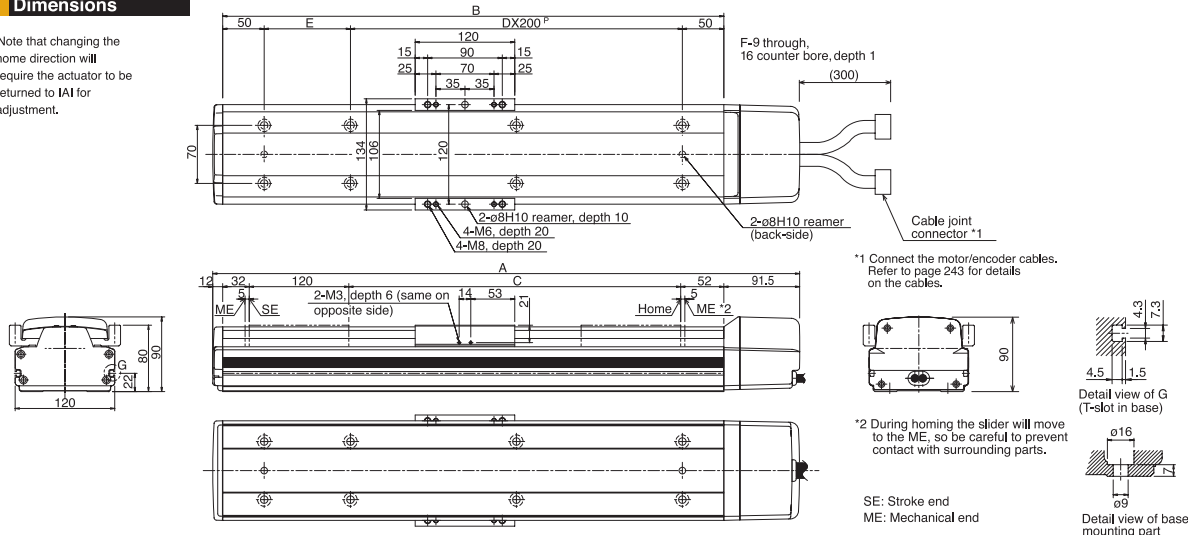

Dimensions, Weight and Maximum Speed by Stroke

Stroke	100	(150)	200	(250)	300	(350)	400	(450)	500	(550)	600	(650)	700	(750)	800	(850)	900	(950)	1000
A	407.5	457.5	507.5	557.5	607.5	657.5	707.5	757.5	807.5	857.5	907.5	957.5	1007.5	1057.5	1107.5	1157.5	1207.5	1257.5	1307.5
B	304	354	404	454	504	554	604	654	704	754	804	854	904	954	1004	1054	1104	1154	1204
C	100	150	200	250	300	350	400	450	500	550	600	650	700	750	800	850	900	950	1000
D	0	0	1	1	1	1	2	2	2	3	3	3	3	3	4	4	4	4	5
E	204	254	104	154	204	254	104	154	204	254	104	154	204	254	104	154	204	254	104
F	4	4	6	6	6	6	8	8	8	8	10	10	10	10	12	12	12	12	14
Weight (kg)	6.6	7.1	7.6	8.1	8.7	9.2	9.7	10.2	10.8	11.3	11.8	12.3	12.9	13.4	13.9	14.4	15.0	15.5	16.0
Maximum speed (mm/s)	Lead 30	1500																	
	Lead 20	1000																	
	Lead 10	500																	
													1500	1190	965			810	
													1000	795	645			540	
													480	380	310			255	

Applicable Controller Specifications

Applicable controller	Maximum number of controlled axes	Compatible encoder type	Program operation	Positioner operation	Pulse-train control	Supply voltage	Page
X-SEL	4 axes	Absolute/incremental	○	△	×	AC100/200V	
E-Con	1 axis	Absolute/incremental	×	○	×	AC100/200V	
P-Driver	1 axis	Incremental	×	×	○	AC100/200V	

Caution

(Note 1) The strokes that are set in increments of 50 mm are semi-standard settings.
 (Note 2) A longer stroke will result in a lower maximum speed to prevent the ball screw from reaching a dangerous speed. (Refer to the above table for the maximum speed at a given stroke.)
 (Note 3) Refer to page 40 for the relationship of acceleration and load capacity. (Notes 4, 5, 6) The figures in brackets apply to the ISPA Series.
 Other specification values apply to both the ISA and ISPA Series.
 (Note 7) The maximum cable length is 30 m. Specify the desired length in meters (e.g., X08 = 8 m).

* Refer to page 9 for other points to note.

ISA-MXXM Single-Axis Robot: Medium X-Axis Mid-Support Type, Actuator Width 120mm, 200W, Straight Shape

ISPA-MXXM Single-Axis Robot: Medium X-Axis Mid-Support Type, Actuator Width 120mm, 200W, Straight Shape **High-Precision Specification**

Type	Medium X-axis (120-mm wide) mid-support type	Stroke	800 ~ 2000mm	Load capacity	40kg (horizontal)
------	--	--------	--------------	---------------	-------------------

Model specification items	Series	Type	Encoder type	Motor output	Lead	Stroke	Applicable controller	Cable length	Options
	ISA[ISPA]	-MXXM	-A	-200	-30	-2000	-T1	-S	-NM



* Refer to page 11 for the details of model specification items.

Models/Specifications

Model	Encoder type	Motor output (W)	Lead (mm)	Stroke (mm) In increments of 10mm	Speed (Note 1) (mm/s)	Acceleration (Note 2)		Load capacity (Note 2)		Rated thrust (N)
						Horizontal (G)	Vertical (G)	Horizontal (kg)	Vertical (kg)	
						Rated	Maximum	Rated	Maximum	
ISA [ISPA] -MXXM-A-200-30-***-T1-△-□	Absolute	200	30	800 ~ 2000	1 ~ 1500	0.3	Horizontal application	25	Horizontal application	113
ISA [ISPA] -MXXM-A-200-20-***-T1-△-□			20		1 ~ 1000	0.3		40		169.5
ISA [ISPA] -MXXM-I-200-30-***-T1-△-□	Incremental	200	30	800 ~ 2000	1 ~ 1500	0.3	only	25	only	113
ISA [ISPA] -MXXM-I-200-20-***-T1-△-□			20		1 ~ 1000	0.3		40		169.5

* In the above model names, *** indicates the stroke, △ the cable length and □ the applicable options.

*1.0G=9800mm/sec²

Options

Name	Code	Page	Name	Code	Page
AQ seal	AQ	P13	Master-axis designation	LM	P14
Brake	B	P13	Master-axis designation (sensor on opposite side)	LLM	P14
Creep sensor	C	P13	Reverse homing specification	NM	P14
Creep sensor on opposite side	CL	P13	Guide with ball-retaining mechanism	RT	P14
Home limit switch	L	P14	Slave-axis designation	S	P14
Home limit switch on opposite side	LL	P14			

Common Specifications

* Refer to page 10 for the details of common specification items.

Positioning repeatability (Note 3)	±0.02mm [±0.01mm]
Drive system (Note 4)	Ball screw ø16mm, rolled C10 [equivalent to rolled C5]
Lost motion (Note 5)	0.05mm or less [0.02mm or less]
Guide	integrated with base
Allowable static moment	Refer to page 242
Allowable dynamic moment	Ma: 69.6N•m Mb: 99.0N•m Mc: 161.7N•m
Overhang load length	Ma direction: 600mm or less, Mb/Mc directions: 600mm or less
Base	Material: Aluminum, with white alumite treatment
Cable length (Note 6)	N: None, S: 3m, M: 5m, X□□: Specified length
Ambient operating temperature/humidity	0 to 40°C, 85%RH max. (non-condensing)

Dimensions

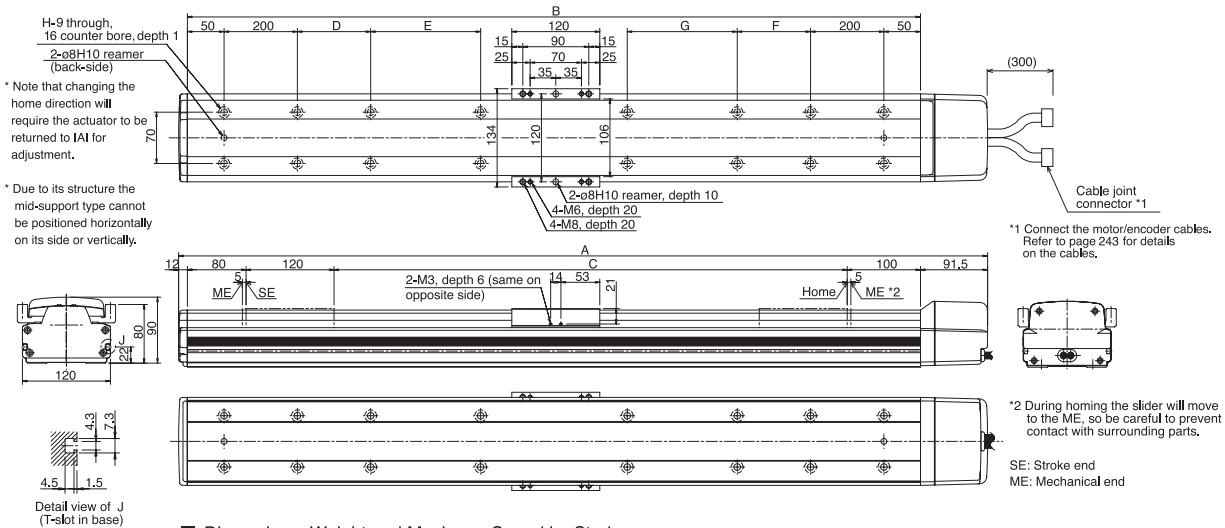

Dimensions, Weight and Maximum Speed by Stroke

Stroke	800	900	1000	1100	1200	1300	1400	1500	1600	1700	1800	1900	2000	
A	1203.5	1303.5	1403.5	1503.5	1603.5	1703.5	1803.5	1903.5	2003.5	2103.5	2203.5	2303.5	2403.5	
B	1100	1200	1300	1400	1500	1600	1700	1800	1900	2000	2100	2200	2300	
C	800	900	1000	1100	1200	1300	1400	1500	1600	1700	1800	1900	2000	
D	0	0	200	250	300	350	400	450	500	550	200	200	200	
E	0	0	0	0	0	0	0	0	0	0	400	450	500	
F	200	200	200	250	300	350	400	450	500	550	200	200	200	
G	0	0	0	0	0	0	0	0	0	0	400	450	500	
H	10	10	12	12	12	12	12	12	12	12	16	16	16	
Weight (kg)	15.0	16.1	17.1	18.2	19.2	20.3	21.3	22.4	23.4	24.5	25.5	26.6	27.6	
Maximum speed (mm/s)	Lead 30	1500						1425	1200	1050	900	825	750	675
	Lead 20	1000						950	800	700	600	550	500	450

Applicable Controller Specifications

Applicable controller	Maximum number of controlled axes	Compatible encoder type	Program operation	Positioner operation	Pulse-train control	Supply voltage	Page
X-SEL	4 axes	Absolute/incremental	○	△	×	AC100/200V	
E-Con	1 axis	Absolute/incremental	×	○	×	AC100/200V	
P-Driver	1 axis	Incremental	×	×	○	AC100/200V	



(Note 1) The strokes that are set in increments of 50 mm are semi-standard settings.
 (Note 2) Refer to page 40 for the relationship of acceleration and load capacity.
 (Notes 3, 4, 5) The figures in brackets apply to both the ISA and ISPA Series.
 Other specification values apply to both the ISA and ISPA Series.
 (Note 6) The maximum cable length is 30 m. Specify the desired length in meters (e.g., X08 = 8 m).

* Refer to page 9 for other points to note.

ISA-MYM-100 Single-Axis Robot: Medium Y-Axis Long Slider Type, Actuator Width 120mm, 100W, Straight Shape

ISPA-MYM-100 Single-Axis Robot: Medium Y-Axis Long Slider Type, Actuator Width 120mm, 100W, Straight Shape High-Precision Specification

Type Medium Y-axis (120-mm wide long slider type) Stroke 100 ~ 1000mm Load capacity 80kg (horizontal)/19kg (vertical)

Model specification items Series Type Encoder type Motor output Lead Stroke Applicable controller Cable length Options
 ISA[ISPA] - MYM - A - 100 - 20 - 1000 - T1 - S - NM

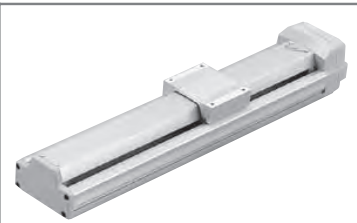

* Refer to page 11 for the details of model specification items.

Models/Specifications

Model	Encoder type	Motor output (W)	Lead (mm)	Stroke (mm) In increments of 50mm (Note 1)	Speed (Note 2) (mm/s)	Acceleration (Note 3)				Load capacity (Note 3)				Rated thrust (N)
						Horizontal (G)		Vertical (G)		Horizontal (kg)		Vertical (kg)		
						Rated	Maximum	Rated	Maximum	Rated	Maximum	Rated	Maximum	
ISA [ISPA] -MYM-A-100-20-***-T1-△-□	Absolute	100	20	100 ~ 1000	1 ~ 1000	0.3	1.0	0.3	0.8	20	6	3.5	2	84.3
ISA [ISPA] -MYM-A-100-10-***-T1-△-□			10		1 ~ 500	0.3	0.6	0.3	0.5	40	20	9	7	169.5
ISA [ISPA] -MYM-A-100-5-***-T1-△-□			5		1 ~ 250	0.15	0.5	0.15	0.3	80	45	19	15	340.1
ISA [ISPA] -MYM-I-100-20-***-T1-△-□	Incremental	100	20	100 ~ 1000	1 ~ 1000	0.3	1.0	0.3	0.8	20	6	3.5	2	84.3
ISA [ISPA] -MYM-I-100-10-***-T1-△-□			10		1 ~ 500	0.3	0.6	0.3	0.5	40	20	9	7	169.5
ISA [ISPA] -MYM-I-100-5-***-T1-△-□			5		1 ~ 250	0.15	0.5	0.15	0.3	80	45	19	15	340.1

* In the above model names, *** indicates the stroke, △ the cable length and □ the applicable options.

*1,0G=9800mm/sec²

Options

Name	Code	Page	Name	Code	Page
AQ seal	AQ	P13	Master-axis designation	LM	P14
Brake	B	P13	Master-axis designation (sensor on opposite side)	LLM	P14
Creep sensor	C	P13	Reverse homing specification	NM	P14
Creep sensor on opposite side	CL	P13	Guide with ball-retaining mechanism	RT	P14
Home limit switch	L	P14	Slave-axis designation	S	P14
Home limit switch on opposite side	LL	P14			

Common Specifications

* Refer to page 10 for the details of common specification items.

Positioning repeatability (Note 4)	±0.02mm [±0.01mm]
Drive system (Note 5)	Ball screw ø16mm, rolled C10 [equivalent to rolled C5]
Lost motion (Note 6)	0.05mm or less [0.02mm or less]
Guide	integrated with base
Allowable static moment	Refer to page 242
Allowable dynamic moment	Ma: 69.6N·m Mb: 99.0N·m Mc: 81.3N·m
Overhang load length	Ma direction: 600mm or less, Mb/Mc directions: 600mm or less
Base	Material: Aluminum, with white alumite treatment
Cable length (Note 7)	N: None, S: 3m, M: 5m, X□□: Specified length
Ambient operating temperature/humidity	0 to 40°C, 85%RH max. (non-condensing)

Dimensions

* Note that changing the home direction will require the actuator to be returned to IAI for adjustment.

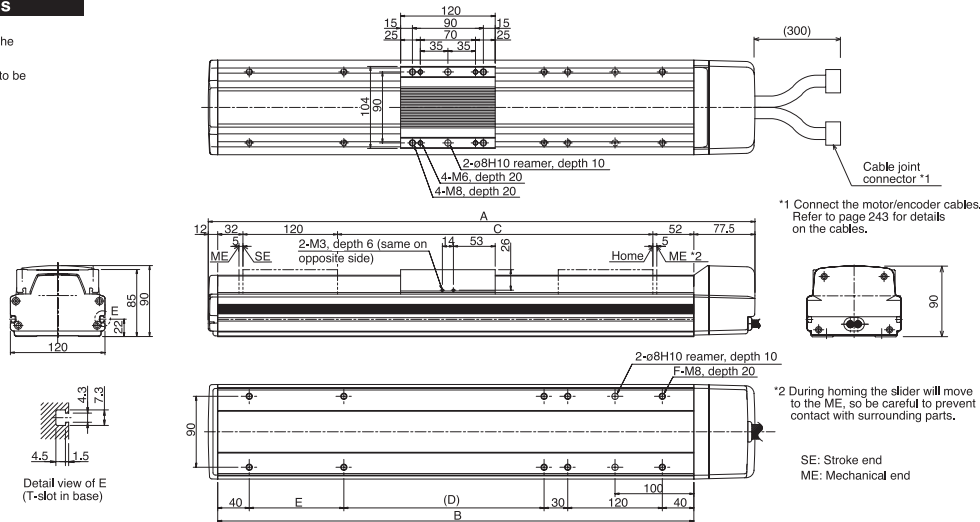

Dimensions, Weight and Maximum Speed by Stroke

Stroke	100	(150)	200	(250)	300	(350)	400	(450)	500	(550)	600	(650)	700	(750)	800	(850)	900	(950)	1000
A	393.5	443.5	493.5	543.5	593.5	643.5	693.5	743.5	793.5	843.5	893.5	943.5	993.5	1043.5	1093.5	1143.5	1193.5	1243.5	1293.5
B	304	354	404	454	504	554	604	654	704	754	804	854	904	954	1004	1054	1104	1154	1204
C	100	150	200	250	300	350	400	450	500	550	600	650	700	750	800	850	900	950	1000
D	-	-	54	104	154	204	254	304	354	404	454	504	554	604	654	704	754	804	854
E	120	-	120	120	120	120	120	120	120	120	120	120	120	120	120	120	120	120	120
F	10	8	10	10	10	10	10	10	10	10	10	10	10	10	10	10	10	10	10
Weight (kg)	6.3	6.8	7.3	7.8	8.3	8.8	9.3	9.9	10.4	10.9	11.4	11.9	12.4	12.9	13.4	13.9	14.4	14.9	15.4
Maximum speed (mm/s)	Lead 20	1000																	
	Lead 10	500																	
	Lead 5	250																	

Applicable Controller Specifications

Applicable controller	Maximum number of controlled axes	Compatible encoder type	Program operation	Positioner operation	Pulse-train control	Supply voltage	Page
X-SEL	4 axes	Absolute/incremental	○	△	×	AC100/200V	
E-Con	1 axis	Absolute/incremental	×	○	×	AC100/200V	
P-Driver	1 axis	Incremental	×	×	○	AC100/200V	



(Note 1) The strokes that are set in increments of 50 mm are semi-standard settings.
 (Note 2) A longer stroke will result in a lower maximum speed to prevent the ball screw from reaching a dangerous speed. (Refer to the above table for the maximum speed at a given stroke.)
 (Note 3) Refer to page 40 for the relationship of acceleration and load capacity. (Notes 4, 5, 6) The figures in brackets apply to the ISPA Series. Other specification values apply to both the ISA and ISPA Series.
 (Note 7) The maximum cable length is 30 m. Specify the desired length in meters (e.g., X06 = 6 m).

* Refer to page 9 for other points to note.

ISA-MYM-200 Single-Axis Robot: Medium Y-Axis Long Slider Type, Actuator Width 120mm, 200W, Straight Shape

ISPA-MYM-200 Single-Axis Robot: Medium Y-Axis Long Slider Type, Actuator Width 120mm, 200W, Straight Shape High-Precision Specification

Type Medium Y-axis (120-mm wide) long slider type Stroke 100 ~ 1000mm Load capacity 80kg (horizontal)/19kg (vertical)

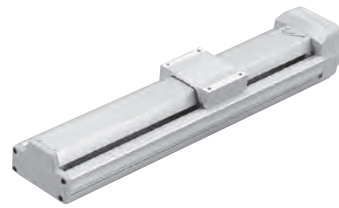

Model specification items Series Type Encoder type Motor output Lead Stroke Applicable controller Cable length Options
 ISA[ISPA] - MYM - A - 200 - 30 - 1000 - T1 - S - NM

* Refer to page 11 for the details of model specification items.

Models/Specifications

Model	Encoder type	Motor output (W)	Lead (mm)	Stroke (mm) In increments of 50mm (Note 1)	Speed (Note 2) (mm/s)	Acceleration (Note 3)				Load capacity (Note 3)				Rated thrust (N)
						Horizontal (G)		Vertical (G)		Horizontal (kg)		Vertical (kg)		
						Rated	Maximum	Rated	Maximum	Rated acceleration	Maximum acceleration	Rated acceleration	Maximum acceleration	
ISA [ISPA] -MYM-A- 200-30- ***T1-△-□	Absolute	200	30	100 ~ 1000	1 ~ 1500	0.3	1.0	0.3	1.0	25	10	6	2	113
ISA [ISPA] -MYM-A- 200-20- ***T1-△-□			20		1 ~ 1000	0.3	1.0	0.3	0.8	40	12	9	5	169.5
ISA [ISPA] -MYM-A- 200-10- ***T1-△-□			10		1 ~ 500	0.3	0.6	0.3	0.5	80	40	19	15	340.1
ISA [ISPA] -MYM-I- 200-30- ***T1-△-□	Incremental	200	30	100 ~ 1000	1 ~ 1500	0.3	1.0	0.3	1.0	25	10	6	2	113
ISA [ISPA] -MYM-I- 200-20- ***T1-△-□			20		1 ~ 1000	0.3	1.0	0.3	0.8	40	12	9	5	169.5
ISA [ISPA] -MYM-I- 200-10- ***T1-△-□			10		1 ~ 500	0.3	0.6	0.3	0.5	80	40	19	15	340.1

* In the above model names, *** indicates the stroke, △ the cable length and □ the applicable options.

*1.0G=9800mm/sec²

Options

Name	Code	Page	Name	Code	Page
AQ seal	AQ	P13	Master-axis designation	LM	P14
Brake	B	P13	Master-axis designation (sensor on opposite side)	LLM	P14
Creep sensor	C	P13	Reverse homing specification	NM	P14
Creep sensor on opposite side	CL	P13	Guide with ball-retaining mechanism	RT	P14
Home limit switch	L	P14	Slave-axis designation	S	P14
Home limit switch on opposite side	LL	P14			

Common Specifications

* Refer to page 10 for the details of common specification items.

Positioning repeatability (Note 4)	±0.02mm [±0.01mm]
Drive system (Note 5)	Ball screw ø16mm, rolled C10 [equivalent to rolled C5]
Lost motion (Note 6)	0.05mm or less [0.02mm or less]
Guide	integrated with base
Allowable static moment	Refer to page 242
Allowable dynamic moment	Ma: 69.6N·m Mb: 99.0N·m Mc: 81.3N·m
Overhang load length	Ma direction: 600mm or less, Mb/Mc directions: 600mm or less
Base	Material: Aluminum, with white alumite treatment
Cable length (Note 7)	N: None, S: 3m, M: 5m, X□□: Specified length
Ambient operating temperature/humidity	0 to 40°C, 85%RH max. (non-condensing)

Dimensions

* Note that changing the home direction will require the actuator to be returned to |A| for adjustment.

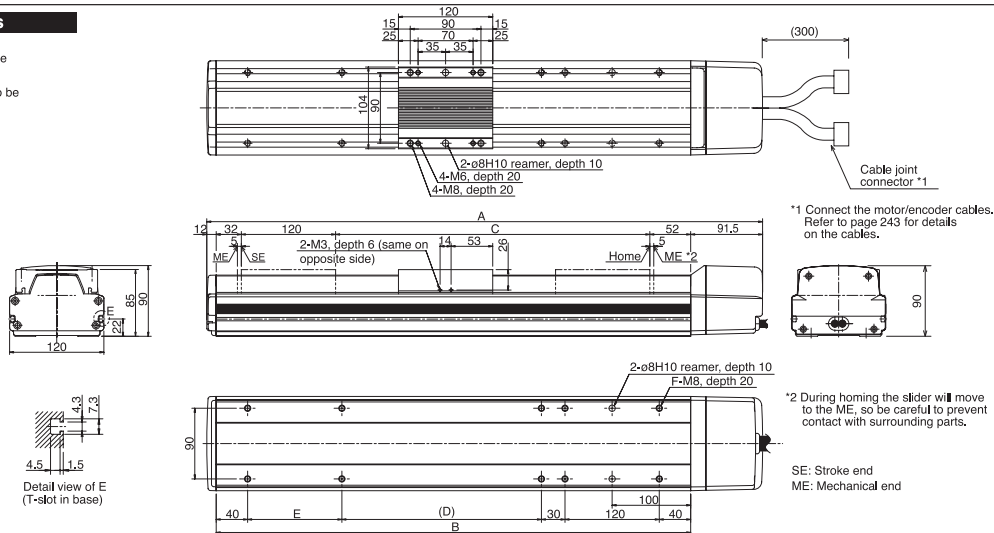

Dimensions, Weight and Maximum Speed by Stroke

Stroke	100	(150)	200	(250)	300	(350)	400	(450)	500	(550)	600	(650)	700	(750)	800	(850)	900	(950)	1000		
A	407.5	457.5	507.5	557.5	607.5	657.5	707.5	757.5	807.5	857.5	907.5	957.5	1007.5	1057.5	1107.5	1157.5	1207.5	1257.5	1307.5		
B	304	354	404	454	504	554	604	654	704	754	804	854	904	954	1004	1054	1104	1154	1204		
C	100	150	200	250	300	350	400	450	500	550	600	650	700	750	800	850	900	950	1000		
D	-	-	54	104	154	204	254	304	354	404	454	504	554	604	654	704	754	804	854		
E	120	-	120	120	120	120	120	120	120	120	120	120	120	120	120	120	120	120	120		
F	10	8	10	10	10	10	10	10	10	10	10	10	10	10	10	10	10	10	10		
Weight (kg)	6.8	7.3	7.8	8.3	8.8	9.3	9.8	10.4	10.9	11.4	11.9	12.4	12.9	13.4	13.9	14.4	14.9	15.4	15.9		
Maximum speed (mm/s)	Lead 30	1500														1500	1190		965		810
	Lead 20	1000														1000	795		645		540
	Lead 10	500														480	380		310		255

Applicable Controller Specifications

Applicable controller	Maximum number of controlled axes	Compatible encoder type	Program operation	Positioner operation	Pulse-train control	Supply voltage	Page
X-SEL	4 axes	Absolute/Incremental	○	△	×	AC100/200V	
E-Con	1 axis	Absolute/Incremental	×	○	×	AC100/200V	
P-Driver	1 axis	Incremental	×	×	○	AC100/200V	



(Note 1) The strokes that are set in increments of 50 mm are semi-standard settings.
 (Note 2) A longer stroke will result in a lower maximum speed to prevent the ball screw from reaching a dangerous speed. (Refer to the above table for the maximum speed at a given stroke.)
 (Note 3) Refer to page 40 for the relationship of acceleration and load capacity. (Notes 4, 5, 6) The figures in brackets apply to the ISPA Series.
 Other specification values apply to both the ISA and ISPA Series.
 (Note 7) The maximum cable length is 30 m. Specify the desired length in meters (e.g., X08 = 8 m).

* Refer to page 9 for other points to note.

ISA-MZM-100 Single-Axis Robot: Medium Vertical-Axis Long Slider Type, Actuator Width 120mm, 100W, Straight Shape
ISPA-MZM-100 Single-Axis Robot: Medium Vertical-Axis Long Slider Type, Actuator Width 120mm, 100W, Straight Shape High-Precision Specification

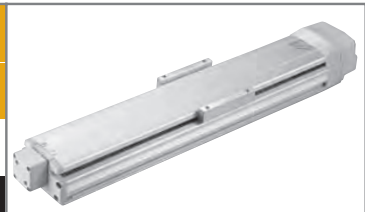

Type	Medium vertical-axis (120-mm wide) long slider type	Stroke	100 ~ 1000mm	Vertical application only (with standard brake)	19kg																				
<table border="1"> <tr> <td>Model specification items</td> <td>Series</td> <td>Type</td> <td>Encoder type</td> <td>Motor output</td> <td>Lead</td> <td>Stroke</td> <td>Applicable controller</td> <td>Cable length</td> <td>Options</td> </tr> <tr> <td colspan="10">ISA[ISPA] - MZM - A - 100 - 10 - 1000 - T1 - S - B-L</td> </tr> </table>						Model specification items	Series	Type	Encoder type	Motor output	Lead	Stroke	Applicable controller	Cable length	Options	ISA[ISPA] - MZM - A - 100 - 10 - 1000 - T1 - S - B-L									
Model specification items	Series	Type	Encoder type	Motor output	Lead	Stroke	Applicable controller	Cable length	Options																
ISA[ISPA] - MZM - A - 100 - 10 - 1000 - T1 - S - B-L																									

* Refer to page 11 for the details of model specification items.

Models/Specifications

Model	Encoder type	Motor output (W)	Lead (mm)	Stroke (mm) In increments of 50mm (Note 1)	Speed (Note 2) (mm/s)	Acceleration (Note 3)				Load capacity (Note 3)				Rated thrust (N)					
						Horizontal (kg)		Vertical (kg)		Horizontal (kg)		Vertical (kg)							
						Rated	Maximum	Rated	Maximum	Rated	Maximum	Rated	Maximum						
ISA [ISPA] -MZM-A-100-10-***-T1-Δ-B-□	Absolute	100	10	100 ~ 1000	1 ~ 500	Vertical application only	0.3	0.5	Vertical application only	9	7	169.5							
ISA [ISPA] -MZM-A-100-5-***-T1-Δ-B-□			5		1 ~ 250								0.15	0.3	19	15	340.1		
ISA [ISPA] -MZM-I-100-10-***-T1-Δ-B-□	Incremental	100	10	100 ~ 1000	1 ~ 500								Vertical application only	0.3	0.5	Vertical application only	9	7	169.5
ISA [ISPA] -MZM-I-100-5-***-T1-Δ-B-□			5		1 ~ 250														

* In the above model names, *** indicates the stroke, Δ the cable length and □ the applicable options.

*1,0G=9800mm/sec²

Options

Name	Code	Page	Name	Code	Page
AQ seal	AQ	P13	Master-axis designation	LM	P14
Brake	B	P13	Master-axis designation (sensor on opposite side)	LLM	P14
Creep sensor	C	P13	Reverse homing specification	NM	P14
Creep sensor on opposite side	CL	P13	Guide with ball-retaining mechanism	RT	P14
Home limit switch	L	P14	Slave-axis designation	S	P14
Home limit switch on opposite side	LL	P14			

* The MZM type comes standard with a brake (B).

Common Specifications

* Refer to page 10 for the details of common specification items.

Positioning repeatability (Note 4)	±0.02mm [±0.01mm]
Drive system (Note 5)	Ball screw ø16mm, rolled C10 [equivalent to rolled C5]
Lost motion (Note 6)	0.05mm or less [0.02mm or less]
Guide	integrated with base
Allowable static moment	Refer to page 242
Allowable dynamic moment	Ma: 69.6N·m Mb: 99.0N·m Mc: 81.3N·m
Brake	Comes standard with a dry, single-plate, non-excitation type electromagnetic brake
Base	Material: Aluminum, with white alumite treatment
Cable length (Note 7)	N: None, S: 3m, M: 5m, X□□: Specified length
Ambient operating temperature/humidity	0 to 40°C, 85%RH max. (non-condensing)

Dimensions

* Note that changing the home direction will require the actuator to be returned to IAI for adjustment.

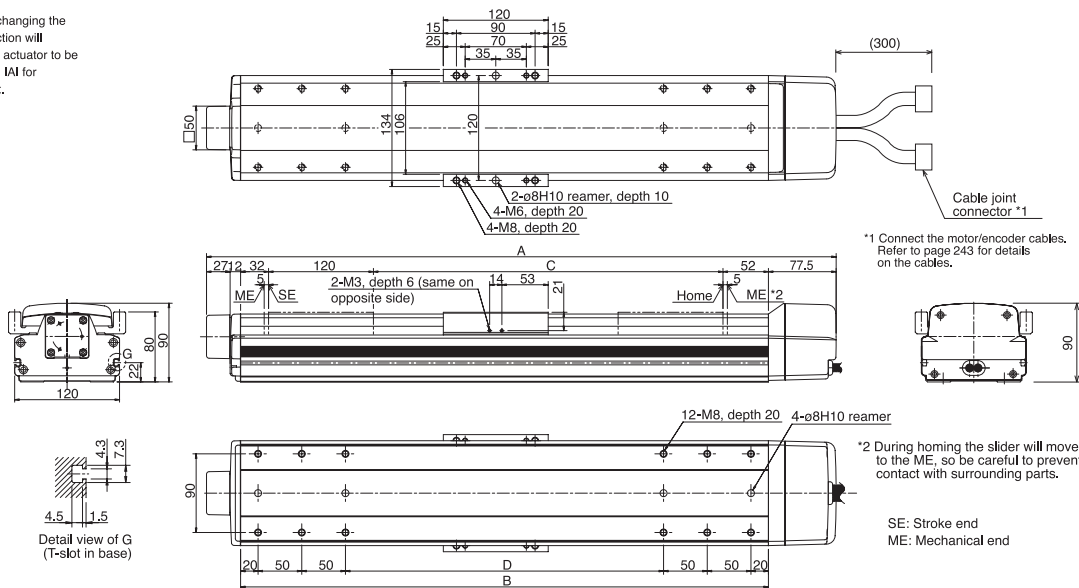

*1 Connect the motor/encoder cables. Refer to page 243 for details on the cables.

*2 During homing the slider will move to the ME, so be careful to prevent contact with surrounding parts.

Dimensions, Weight and Maximum Speed by Stroke

Stroke	100	(150)	200	(250)	300	(350)	400	(450)	500	(550)	600	700	800	900	1000
A	420.5	470.5	520.5	570.5	620.5	670.5	720.5	770.5	820.5	870.5	920.5	Use the base of the MXM type for 700 and longer strokes. Refer to the drawing on page 18 for the mounting dimensions.			
B	304	354	404	454	504	554	604	654	704	754	804				
C	100	150	200	250	300	350	400	450	500	550	600				
D	64	114	164	214	264	314	364	414	464	514	564				
Weight (kg)	7.1	7.6	8.1	8.6	9.1	9.6	10.1	10.7	11.2	11.7	12.2	13.2	14.2	15.2	16.2
Maximum speed (mm/s)	500											480	380	310	255
Lead	10											220	175	145	120
Lead	5														

Applicable Controller Specifications

Applicable controller	Maximum number of controlled axes	Compatible encoder type	Program operation	Positioner operation	Pulse-train control	Supply voltage	Page
X-SEL	4 axes	Absolute/incremental	○	△	×	AC100/200V	
E-Con	1 axis	Absolute/incremental	×	○	×	AC100/200V	
P-Driver	1 axis	Incremental	×	×	○	AC100/200V	



(Note 1) The strokes that are set in increments of 50 mm are semi-standard settings.
 (Note 2) A longer stroke will result in a lower maximum speed to prevent the ball screw from reaching a dangerous speed. (Refer to the above table for the maximum speed at a given stroke.)
 (Note 3) Refer to page 40 for the relationship of acceleration and load capacity. (Notes 4, 5, 6) The figures in brackets apply to the ISPA Series. Other specification values apply to both the ISA and ISPA Series.
 (Note 7) The maximum cable length is 30 m. Specify the desired length in meters (e.g., X08 = 8 m).

* Refer to page 9 for other points to note.

ISA-MZM-200 Single-Axis Robot: Medium Vertical-Axis Long Slider Type, Actuator Width 120mm, 200W, Straight Shape
ISPA-MZM-200 Single-Axis Robot: Medium Vertical-Axis Long Slider Type, Actuator Width 120mm, 200W, Straight Shape **High-Precision Specification**



Type Medium vertical-axis (120-mm wide) long slider type Stroke 100 ~ 1000mm Vertical application only (with standard brake) 19kg

Model specification items Series Type Encoder type Motor output Lead Stroke Applicable controller Cable length Options
 ISA[ISPA] - MZM - A - 200 - 10 - 1000 - T1 - S - B - L

* Refer to page 11 for the details of model specification items.

Models/Specifications

Model	Encoder type	Motor output (W)	Lead (mm)	Stroke (mm) In increments of 50mm (Note 1)	Speed (Note 2) (mm/s)	Acceleration (Note 3)				Load capacity (Note 3)		Rated thrust (N)		
						Horizontal (G)		Vertical (G)		Horizontal (kg)	Vertical (kg)			
						Rated	Maximum	Rated	Maximum	Rated	Maximum			
ISA [ISPA] -MZM-A-200-10-***-T1-△-B-□	Absolute	200	10	100 ~ 1000	1 ~ 500	Vertical application only		0.3	0.5	Vertical application only		19	15	340.1
ISA [ISPA] -MZM-I-200-10-***-T1-△-B-□	Incremental				1 ~ 500	Vertical application only		0.3	0.5	19	15	340.1		

* In the above model names, *** indicates the stroke, △ the cable length and □ the applicable options.

*1.0G=9800mm/sec²

Options

Name	Code	Page	Name	Code	Page
AQ seal	AQ	P13	Master-axis designation	LM	P14
Brake	B	P13	Master-axis designation (sensor on opposite side)	LLM	P14
Creep sensor	C	P13	Reverse homing specification	NM	P14
Creep sensor on opposite side	CL	P13	Guide with ball-retaining mechanism	RT	P14
Home limit switch	L	P14	Slave-axis designation	S	P14
Home limit switch on opposite side	LL	P14			

* The MZM type comes standard with a brake (B).

Common Specifications

* Refer to page 10 for the details of common specification items.

Positioning repeatability (Note 4)	±0.02mm [±0.01mm]
Drive system (Note 5)	Ball screw ø16mm, rolled C10 [equivalent to rolled C5]
Lost motion (Note 6)	0.05mm or less [0.02mm or less]
Guide	integrated with base
Allowable static moment	Refer to page 242
Allowable dynamic moment	Ma: 69.6N·m Mb: 99.0N·m Mc: 81.3N·m
Brake	Comes standard with a dry, single-plate, non-excitation type electromagnetic brake
Base	Material: Aluminum, with white alumite treatment
Cable length (Note 7)	N: None, S: 3m, M: 5m, X□□: Specified length
Ambient operating temperature/humidity	0 to 40°C, 85%RH max. (non-condensing)

Dimensions

* Note that changing the home direction will require the actuator to be returned to IA1 for adjustment.

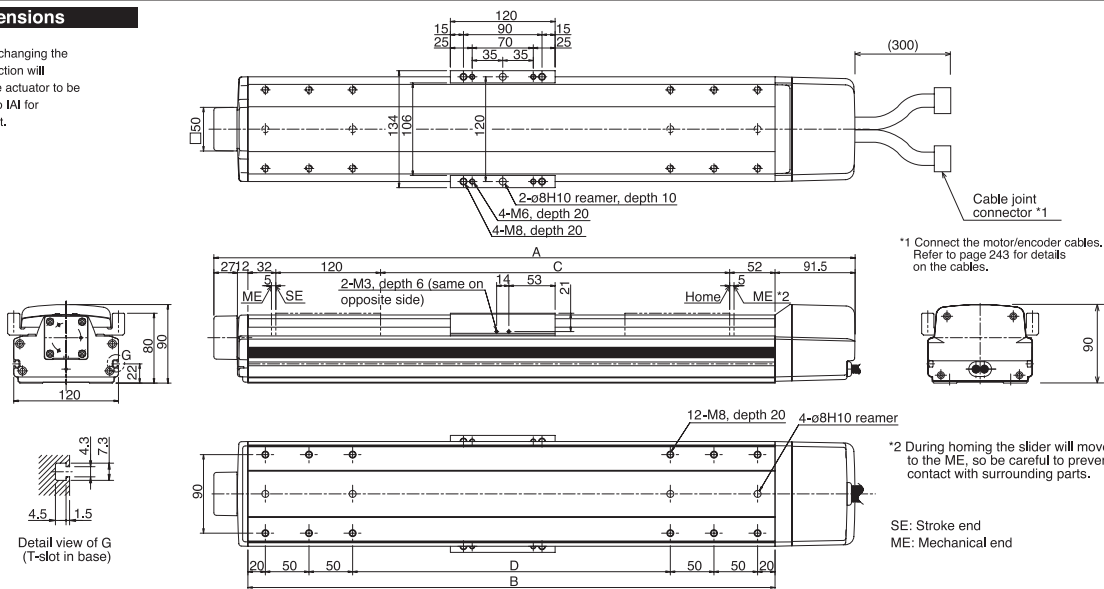

*1 Connect the motor/encoder cables. Refer to page 243 for details on the cables.

*2 During homing the slider will move to the ME, so be careful to prevent contact with surrounding parts.

SE: Stroke end
ME: Mechanical end

Dimensions, Weight and Maximum Speed by Stroke

Stroke	100	(150)	200	(250)	300	(350)	400	(450)	500	(550)	600	700	800	900	1000
A	434.5	484.5	534.5	584.5	634.5	684.5	734.5	784.5	834.5	884.5	934.5	Use the base of the MXM type for 700 and longer strokes. Refer to the drawing on page 19 for the mounting dimensions.			
B	304	354	404	454	504	554	604	654	704	754	804				
C	100	150	200	250	300	350	400	450	500	550	600				
D	64	114	164	214	264	314	364	414	464	514	564				
Weight (kg)	7.1	7.6	8.1	8.6	9.1	9.6	10.1	10.7	11.2	11.7	12.2	13.2	14.2	15.2	16.2
Maximum speed (mm/s)	500														

Applicable Controller Specifications

Applicable controller	Maximum number of controlled axes	Compatible encoder type	Program operation	Positioner operation	Pulse-train control	Supply voltage	Page
X-SEL	4 axes	Absolute/Incremental	○	△	×	AC100/200V	
E-Con	1 axis	Absolute/Incremental	×	○	×	AC100/200V	
P-Driver	1 axis	Incremental	×	×	○	AC100/200V	

* The MZM type comes standard with a brake, so use a controller of brake specification.



(Note 1) The strokes that are set in increments of 50 mm are semi-standard settings.
 (Note 2) A longer stroke will result in a lower maximum speed to prevent the ball screw from reaching a dangerous speed. (Refer to the above table for the maximum speed at a given stroke.)
 (Note 3) Refer to page 40 for the relationship of acceleration and load capacity. (Notes 4, 5, 6) The figures in brackets apply to the ISPA Series.
 Other specification values apply to both the ISA and ISPA Series.
 (Note 7) The maximum cable length is 30 m. Specify the desired length in meters (e.g., X08 = 8 m).

* Refer to page 9 for other points to note.

ISA-LXM-200 Single-Axis Robot: Large X-Axis Long Slider Type, Actuator Width 150mm, 200W, Straight Shape

ISPA-LXM-200 Single-Axis Robot: Large X-Axis Long Slider Type, Actuator Width 150mm, 200W, Straight Shape **High-Precision Specification**

Type	Large X-axis (150-mm wide) long slider type	Stroke	100 ~ 1200mm	Load capacity	80kg (horizontal)/19kg (vertical)
------	---	--------	--------------	---------------	-----------------------------------

Model specification items	Series	Type	Encoder type	Motor output	Lead	Stroke	Applicable controller	Cable length	Options
ISA[ISPA] - LXM - A - 200 - 10 - 1200 - T1 - S - B									



* Refer to page 11 for the details of model specification items.

Models/Specifications

Model	Encoder type	Motor output (W)	Lead (mm)	Stroke (mm) In increments of 50mm (Note 1)	Speed (Note 2) (mm/s)	Acceleration (Note 3)				Load capacity (Note 3)				Rated thrust (N)
						Horizontal (G)		Vertical (G)		Horizontal (kg)		Vertical (kg)		
						Rated	Maximum	Rated	Maximum	Rated	Maximum	Rated	Maximum	
ISA [ISPA] -LXM-A-200-20-***-T1-△-□	Absolute	200	20	100 ~ 1200	1 ~ 1000	0.3	1.0	0.3	0.8	40	12	9	4	170.5
ISA [ISPA] -LXM-A-200-10-***-T1-△-□			1 ~ 500		0.3	0.6	0.3	0.5	80	40	19	14	340.1	
ISA [ISPA] -LXM-I-200-20-***-T1-△-□	Incremental	20	1 ~ 1000		0.3	1.0	0.3	0.8	40	12	9	4	170.5	
ISA [ISPA] -LXM-I-200-10-***-T1-△-□		10	1 ~ 500		0.3	0.6	0.3	0.5	80	40	19	14	340.1	

* In the above model names, *** indicates the stroke, △ the cable length and □ the applicable options.

*1.0G=9800mm/sec²

Options

Name	Code	Page	Name	Code	Page
AQ seal	AQ	P13	Master-axis designation	LM	P14
Brake	B	P13	Master-axis designation (sensor on opposite side)	LLM	P14
Creep sensor	C	P13	Reverse homing specification	NM	P14
Creep sensor on opposite side	CL	P13	Guide with ball-retaining mechanism	RT	P14
Home limit switch	L	P14	Slave-axis designation	S	P14
Home limit switch on opposite side	LL	P14			

Common Specifications

* Refer to page 10 for the details of common specification items.

Positioning repeatability (Note 4)	±0.02mm [±0.01mm]
Drive system (Note 5)	Ball screw ø20mm, rolled C10 [equivalent to rolled C5]
Lost motion (Note 6)	0.05mm or less [0.02mm or less]
Guide	integrated with base
Allowable static moment	Refer to page 242
Allowable dynamic moment	Ma: 104.9N•m Mb: 149.9N•m Mc: 248.9N•m
Overhang load length	Ma direction: 750mm or less, Mb/Mc directions: 750mm or less
Base	Material: Aluminum, with white alumite treatment
Cable length (Note 7)	N: None, S: 3m, M: 5m, X□□: Specified length
Ambient operating temperature/humidity	0 to 40°C, 85%RH max. (non-condensing)

Dimensions

* Note that changing the home direction will require the actuator to be returned to IAI for adjustment.

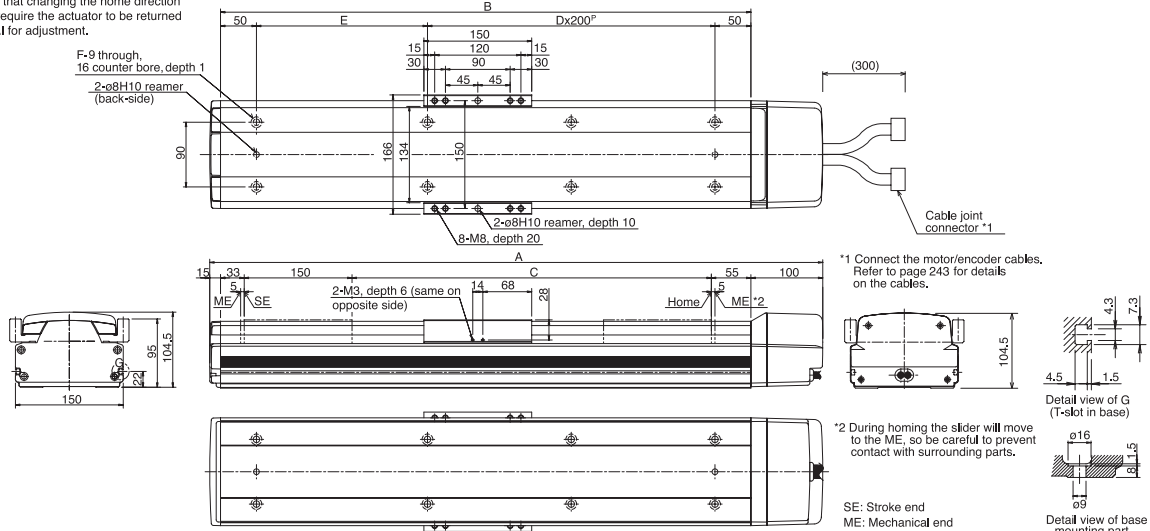

Dimensions, Weight and Maximum Speed by Stroke

Stroke	100	(150)	200	(250)	300	(350)	400	(450)	500	(550)	600	(650)	700	(750)	800	(850)	900	(950)	1000	(1050)	1100	(1150)	1200
A	453	503	553	603	653	703	753	803	853	903	953	1003	1053	1103	1153	1203	1253	1303	1353	1403	1453	1503	1553
B	338	388	438	488	538	588	638	688	738	788	838	888	938	988	1038	1088	1138	1188	1238	1288	1338	1388	1438
C	100	150	200	250	300	350	400	450	500	550	600	650	700	750	800	850	900	950	1000	1050	1100	1150	1200
D	0	0	1	1	1	1	2	2	2	3	3	3	3	3	4	4	4	4	5	5	5	5	6
E	238	288	138	188	238	288	138	188	238	288	138	188	238	288	138	188	238	288	138	188	238	288	138
F	4	4	6	6	6	6	8	8	8	8	10	10	10	10	12	12	12	12	14	14	14	14	16
Weight (kg)	11.0	11.8	12.5	13.3	14.0	14.8	15.5	16.3	17.0	17.8	18.5	19.3	20.0	20.8	21.5	22.3	23.0	23.8	24.5	25.3	26.0	26.8	27.5
Maximum speed (mm/s)	Lead 20						1000								1000		830		690		585		500
	Lead 10						500								470		385		320		270		235

Applicable Controller Specifications

Applicable controller	Maximum number of controlled axes	Compatible encoder type	Program operation	Positioner operation	Pulse-train control	Supply voltage	Page
X-SEL	4 axes	Absolute/incremental	○	△	×	AC100/200V	
E-Con	1 axis	Absolute/incremental	×	○	×	AC100/200V	
P-Driver	1 axis	Incremental	×	×	○	AC100/200V	



(Note 1) The strokes that are set in increments of 50 mm are semi-standard settings.
 (Note 2) A longer stroke will result in a lower maximum speed to prevent the ball screw from reaching a dangerous speed. (Refer to the above table for the maximum speed at a given stroke.)
 (Note 3) Refer to page 40 for the relationship of acceleration and load capacity. (Notes 4, 5, 6) The figures in brackets apply to the ISPA Series.
 (Note 7) The maximum cable length is 30 m. Specify the desired length in meters (e.g., X08 = 8 m).

* Refer to page 9 for other points to note.

ISA-LXM-400 Single-Axis Robot: Large X-Axis Long Slider Type, Actuator Width 150mm, 400W, Straight Shape

ISPA-LXM-400 Single-Axis Robot: Large X-Axis Long Slider Type, Actuator Width 150mm, 400W, Straight Shape **High-Precision Specification**

Type Large X-axis (150-mm wide) long slider type Stroke 100 ~ 1200mm Load capacity 80kg (horizontal)/19kg (vertical)



Model specification items Series Type Encoder type Motor output Lead Stroke Applicable controller Cable length Options
 ISA[ISPA] - LXM - A - 400 - 40 - 1200 - T1 - S - B

* Refer to page 11 for the details of model specification items.

Models/Specifications

Model	Encoder type	Motor output (W)	Lead (mm)	Stroke (mm) In increments of 50mm (Note 1)	Speed (Note 2) (mm/s)	Acceleration (Note 3)				Load capacity (Note 3)				Rated thrust (N)
						Horizontal (G)		Vertical (G)		Horizontal (kg)		Vertical (kg)		
						Rated	Maximum	Rated	Maximum	Rated	Maximum	Rated	Maximum	
ISA [ISPA] -LXM-A-400-40-***-T1-△-□	Absolute	400	40	100 ~ 1200	1 ~ 2000	0.3	1.0	0.3	1.0	40	15	9	4	170.0
ISA [ISPA] -LXM-A-400-20-***-T1-△-□			20		1 ~ 1000	0.3	1.0	0.3	0.8	80	24	19	10	340.1
ISA [ISPA] -LXM-I-400-40-***-T1-△-□	Incremental	400	40	100 ~ 1200	1 ~ 2000	0.3	1.0	0.3	1.0	40	15	9	4	170.0
ISA [ISPA] -LXM-I-400-20-***-T1-△-□			20		1 ~ 1000	0.3	1.0	0.3	0.8	80	24	19	10	340.1

* In the above model names, *** indicates the stroke, △ the cable length and □ the applicable options.

*1.0G=9800mm/sec²

Options

Name	Code	Page	Name	Code	Page
AQ seal	AQ	P13	Master-axis designation	LM	P14
Brake	B	P13	Master-axis designation (sensor on opposite side)	LLM	P14
Creep sensor	C	P13	Reverse homing specification	NM	P14
Creep sensor on opposite side	CL	P13	Guide with ball-retaining mechanism	RT	P14
Home limit switch	L	P14	Slave-axis designation	S	P14
Home limit switch on opposite side	LL	P14			

Common Specifications

* Refer to page 10 for the details of common specification items.

Positioning repeatability (Note 4)	±0.02mm [±0.01mm]
Drive system (Note 5)	Ball screw ø20mm, rolled C10 [equivalent to rolled C5]
Lost motion (Note 6)	0.05mm or less [0.02mm or less]
Guide	integrated with base
Allowable static moment	Refer to page 242
Allowable dynamic moment	Ma: 104.9N•m Mb: 149.9N•m Mc: 248.9N•m
Overhang load length	Ma direction: 750mm or less, Mb/Mc directions: 750mm or less
Base	Material: Aluminum, with white alumite treatment
Cable length (Note 7)	N: None, S: 3m, M: 5m, X□□: Specified length
Ambient operating temperature/humidity	0 to 40°C, 85%RH max. (non-condensing)

Dimensions

* Note that changing the home direction will require the actuator to be returned to IA1 for adjustment.

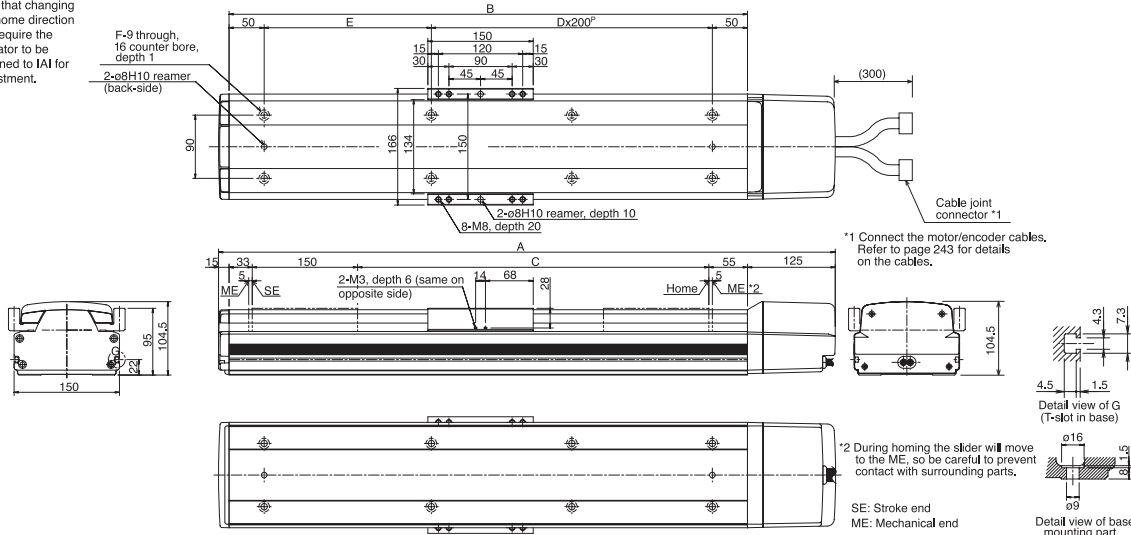

Dimensions, Weight and Maximum Speed by Stroke

Stroke	100	(150)	200	(250)	300	(350)	400	(450)	500	(550)	600	(650)	700	(750)	800	(850)	900	(950)	1000	(1050)	1100	(1150)	1200	
A	478	528	578	628	678	728	778	828	878	928	978	1028	1078	1128	1178	1228	1278	1328	1378	1428	1478	1528	1578	
B	338	388	438	488	538	588	638	688	738	788	838	888	938	988	1038	1088	1138	1188	1238	1288	1338	1388	1438	
C	100	150	200	250	300	350	400	450	500	550	600	650	700	750	800	850	900	950	1000	1050	1100	1150	1200	
D	0	0	1	1	1	1	2	2	2	2	3	3	3	3	4	4	4	4	5	5	5	5	6	
E	238	288	338	388	438	488	538	588	638	688	738	788	838	888	938	988	1038	1088	1138	1188	1238	1288	1338	
F	4	4	6	6	6	6	8	8	8	8	10	10	10	10	12	12	12	12	14	14	14	14	16	
Weight (kg)	12.0	12.8	13.5	14.3	15.0	15.8	16.5	17.3	18.0	18.8	19.5	20.3	21.0	21.8	22.5	23.3	24.0	24.8	25.5	26.3	27.0	27.8	28.5	
Maximum speed (mm/s)	2000																1660		1380		1170		1000	
Lead 40	1000																830		690		585		500	
Lead 20																								

Applicable Controller Specifications

Applicable controller	Maximum number of controlled axes	Compatible encoder type	Program operation	Positioner operation	Pulse-train control	Supply voltage	Page
X-SEL	4 axes	Absolute/Incremental	○	△	×	AC100/200V	
E-Con	1 axis	Absolute/Incremental	×	○	×	AC100/200V	
P-Driver	1 axis	Incremental	×	×	○	AC100/200V	



(Note 1) The strokes that are set in increments of 50 mm are semi-standard settings.
 (Note 2) A longer stroke will result in a lower maximum speed to prevent the ball screw from reaching a dangerous speed. (Refer to the above table for the maximum speed at a given stroke.)
 (Note 3) Refer to page 40 for the relationship of acceleration and load capacity. (Notes 4, 5, 6) The figures in brackets apply to the ISPA Series.
 Other specification values apply to both the ISA and ISPA Series.
 (Note 7) The maximum cable length is 30 m. Specify the desired length in meters (e.g., X08 = 8 m).

* Refer to page 9 for other points to note.

ISA-LXXM-200 Single-Axis Robot: Large X-Axis Mid-Support Type, Actuator Width 150mm, 200W, Straight Shape

ISPA-LXXM-200 Single-Axis Robot: Large X-Axis Mid-Support Type, Actuator Width 150mm, 200W, Straight Shape **High-Precision Specification**

Type	Large X-axis (150-mm wide) mid-support type	Stroke	1000 ~ 2500mm	Load capacity	40kg (horizontal)
Model specification items: Series Type Encoder type Motor output Lead Stroke Applicable controller Cable length Options ISA[ISPA] - LXXM - A - 200 - 20 - 2500 - T1 - S - NM					

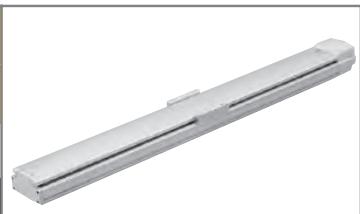

* Refer to page 11 for the details of model specification items.

Models/Specifications

Model	Encoder type	Motor output (W)	Lead (mm)	Stroke (mm) In increments of 100mm	Speed (Note 1) (mm/s)	Acceleration (Note 2)				Load capacity (Note 2)				Rated thrust (N)
						Horizontal (G)		Vertical (G)		Horizontal (kg)		Vertical (kg)		
						Rated	Maximum	Rated	Maximum	Rated	Maximum	Rated	Maximum	
ISA [ISPA] -LXXM-A-200-20-***-T1-△-□	Absolute	200	20	1000 ~ 2500	1 ~ 1000	0.3	Horizontal application only		40	Horizontal application only		170.5		
ISA [ISPA] -LXXM-I-200-20-***-T1-△-□	Incremental		20		1 ~ 1000	0.3	Horizontal application only		40	Horizontal application only		170.5		

* In the above model names, *** indicates the stroke, △ the cable length and □ the applicable options.

*1,0G=9800mm/sec²

Options

Name	Code	Page	Name	Code	Page
AQ seal	AQ	P13	Master-axis designation	LM	P14
Brake	B	P13	Master-axis designation (sensor on opposite side)	LLM	P14
Creep sensor	C	P13	Reverse homing specification	NM	P14
Creep sensor on opposite side	CL	P13	Guide with ball-retaining mechanism	RT	P14
Home limit switch	L	P14	Slave-axis designation	S	P14
Home limit switch on opposite side	LL	P14			

Common Specifications

* Refer to page 10 for the details of common specification items.

Positioning repeatability (Note 3)	±0.02mm [±0.01mm]
Drive system (Note 4)	Ball screw ø20mm, rolled C10 [equivalent to rolled C5]
Lost motion (Note 5)	0.05mm or less [0.02mm or less]
Guide	integrated with base
Allowable static moment	Refer to page 242
Allowable dynamic moment	Ma: 104.9N•m Mb: 149.9N•m Mc: 248.9N•m
Overhang load length	Ma direction: 750mm or less, Mb/Mc directions: 750mm or less
Base	Material: Aluminum, with white alumite treatment
Cable length (Note 6)	N: None, S: 3m, M: 5m, X□□: Specified length
Ambient operating temperature/humidity	0 to 40°C, 85%RH max. (non-condensing)

Dimensions

* Note that changing the home direction will require the actuator to be returned to IAI for adjustment.

* Due to its structure the mid-support type cannot be positioned horizontally on its side or vertically.

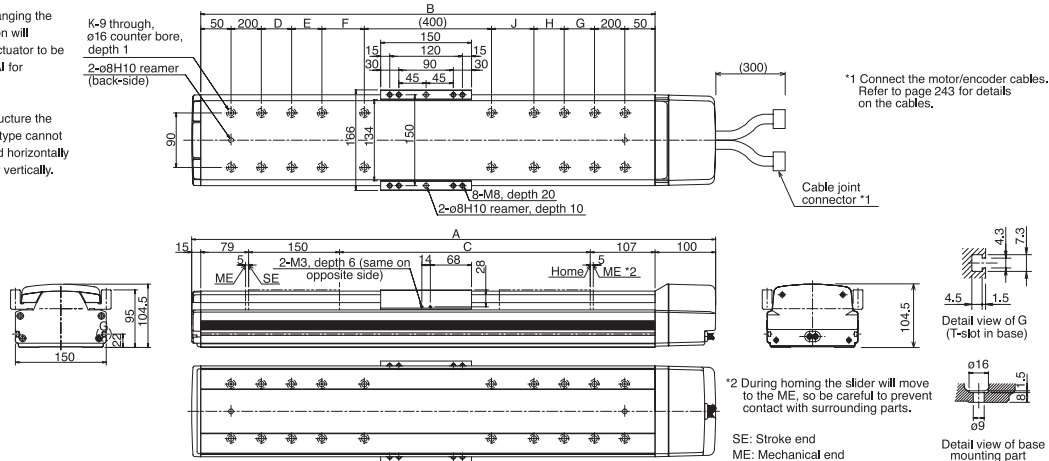

*1 Connect the motor/encoder cables. Refer to page 243 for details on the cables.

*2 During homing the slider will move to the ME, so be careful to prevent contact with surrounding parts.

SE: Stroke end
ME: Mechanical end

Dimensions, Weight and Maximum Speed by Stroke

Stroke	1000	1100	1200	1300	1400	1500	1600	1700	1800	1900	2000	2100	2200	2300	2400	2500
A	1465	1565	1665	1765	1865	1965	2065	2165	2265	2365	2465	2565	2665	2765	2865	2965
B	1350	1450	1550	1650	1750	1850	1950	2050	2150	2250	2350	2450	2550	2650	2750	2850
C	1014	1114	1214	1314	1414	1514	1614	1714	1814	1914	2014	2114	2214	2314	2414	2514
D	225	275	325	375	425	475	525	575	200	200	200	200	200	200	200	200
E	0	0	0	0	0	0	0	0	425	475	525	575	200	200	200	200
F	0	0	0	0	0	0	0	0	0	0	0	425	475	525	575	
G	225	275	325	375	425	475	525	575	200	200	200	200	200	200	200	200
H	0	0	0	0	0	0	0	0	425	475	525	575	200	200	200	200
J	0	0	0	0	0	0	0	0	0	0	0	425	475	525	575	
K	12	12	12	12	12	12	12	12	16	16	16	16	20	20	20	20
Weight (kg)	27.5	29.0	30.5	32.0	33.5	35.0	36.5	38.0	39.5	41.0	42.5	44.0	45.5	47.0	48.5	50.0
Maximum speed (mm/s)	1000					950	830	740	650	590	540	490	440	410	370	340

Applicable Controller Specifications

Applicable controller	Maximum number of controlled axes	Compatible encoder type	Program operation	Positioner operation	Pulse-train control	Supply voltage	Page
X-SEL	4 axes	Absolute/incremental	○	△	×	AC100/200V	
E-Con	1 axis	Absolute/incremental	×	○	×	AC100/200V	
P-Driver	1 axis	Incremental	×	×	○	AC100/200V	



(Note 1) The strokes that are set in increments of 50 mm are semi-standard settings.
 (Note 2) Refer to page 40 for the relationship of acceleration and load capacity.
 (Notes 3, 4, 5) The figures in brackets apply to the ISPA Series.
 Other specification values apply to both the ISA and ISPA Series.
 (Note 6) The maximum cable length is 30 m. Specify the desired length in meters (e.g., X08 = 8 m).

* Refer to page 9 for other points to note.

ISA-LXXM-400 Single-Axis Robot: Large X-Axis Mid-Support Type, Actuator Width 150mm, 400W, Straight Shape

ISPA-LXXM-400 Single-Axis Robot: Large X-Axis Mid-Support Type, Actuator Width 150mm, 400W, Straight Shape **High-Precision Specification**

Type	Large X-axis (150-mm wide) mid-support type	Stroke	1000 ~ 2500mm	Load capacity	80kg (horizontal)
------	---	--------	---------------	---------------	-------------------



Model specification items — Series — Type — Encoder type — Motor output — Lead — Stroke — Applicable controller — Cable length — Options

ISA[ISPA] - LXXM - A - 400 - 40 - 2500 - T1 - S - NM

* Refer to page 11 for the details of model specification items.

Models/Specifications

Model	Encoder type	Motor output (W)	Lead (mm)	Stroke (mm) In increments of 100mm	Speed (Note 1) (mm/s)	Acceleration (Note 2)		Load capacity (Note 2)		Rated thrust (N)
						Horizontal (G)	Vertical (G)	Horizontal (kg)	Vertical (kg)	
						Rated	Maximum	Rated	Maximum	
ISA [ISPA] -LXXM-A-400-40-***-T1-△-□	Absolute	400	40	1000 ~ 2500	1 ~ 2000	0.3	Horizontal application only	40	Horizontal application only	170.0
ISA [ISPA] -LXXM-A-400-20-***-T1-△-□			20		1 ~ 1000			80		340.1
ISA [ISPA] -LXXM-I-400-40-***-T1-△-□	Incremental	400	40	1000 ~ 2500	1 ~ 2000	0.3	Horizontal application only	40	Horizontal application only	170.0
ISA [ISPA] -LXXM-I-400-20-***-T1-△-□			20		1 ~ 1000			80		340.1

* In the above model names, *** indicates the stroke, △ the cable length and □ the applicable options.

*1.0G=9800mm/sec²

Options

Name	Code	Page	Name	Code	Page
AQ seal	AQ	P13	Master-axis designation	LM	P14
Brake	B	P13	Master-axis designation (sensor on opposite side)	LLM	P14
Creep sensor	C	P13	Reverse homing specification	NM	P14
Creep sensor on opposite side	CL	P13	Guide with ball-retaining mechanism	RT	P14
Home limit switch	L	P14	Slave-axis designation	S	P14
Home limit switch on opposite side	LL	P14			

Common Specifications

* Refer to page 10 for the details of common specification items.

Positioning repeatability (Note 3)	±0.02mm [±0.01mm]
Drive system (Note 4)	Ball screw ø20mm, rolled C10 [equivalent to rolled C5]
Lost motion (Note 5)	0.05mm or less [0.02mm or less]
Guide	integrated with base
Allowable static moment	Refer to page 242
Allowable dynamic moment	Ma: 104.9N•m Mb: 149.9N•m Mc: 248.9N•m
Overhang load length	Ma direction: 750mm or less, Mb/Mc directions: 750mm or less
Base	Material: Aluminum, with white alumite treatment
Cable length (Note 6)	N: None, S: 3m, M: 5m, X□□: Specified length
Ambient operating temperature/humidity	0 to 40°C, 85%RH max. (non-condensing)

Dimensions

* Note that changing the home direction will require the actuator to be returned to |A| for adjustment.

* Due to its structure the mid-support type cannot be positioned horizontally on its side or vertically.

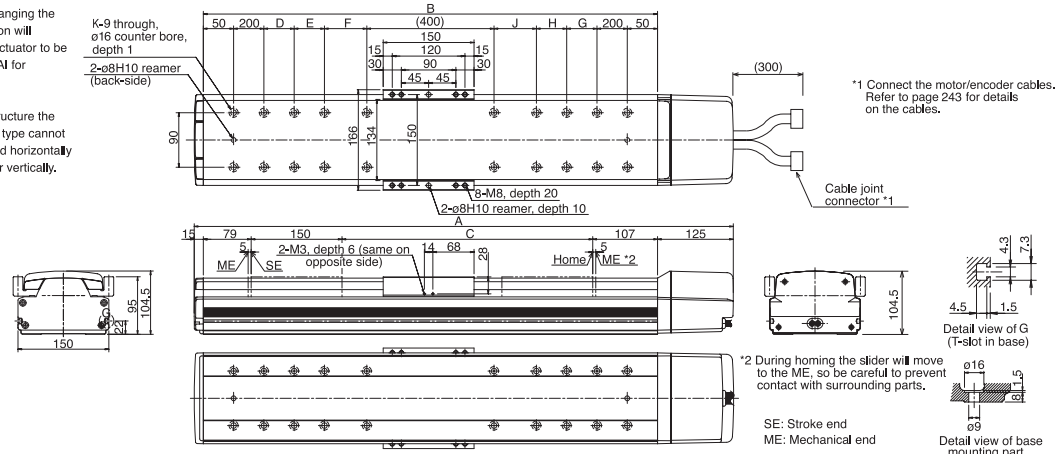

Dimensions, Weight and Maximum Speed by Stroke

Stroke	1000	1100	1200	1300	1400	1500	1600	1700	1800	1900	2000	2100	2200	2300	2400	2500	
A	1490	1590	1690	1790	1890	1990	2090	2190	2290	2390	2490	2590	2690	2790	2890	2990	
B	1350	1450	1550	1650	1750	1850	1950	2050	2150	2250	2350	2450	2550	2650	2750	2850	
C	1014	1114	1214	1314	1414	1514	1614	1714	1814	1914	2014	2114	2214	2314	2414	2514	
D	225	275	325	375	425	475	525	575	200	200	200	200	200	200	200	200	
E	0	0	0	0	0	0	0	0	425	475	525	575	200	200	200	200	
F	0	0	0	0	0	0	0	0	0	0	0	0	425	475	525	575	
G	225	275	325	375	425	475	525	575	200	200	200	200	200	200	200	200	
H	0	0	0	0	0	0	0	0	425	475	525	575	200	200	200	200	
J	0	0	0	0	0	0	0	0	0	0	0	0	425	475	525	575	
K	12	12	12	12	12	12	12	12	16	16	16	16	20	20	20	20	
Weight (kg)	28.5	30.0	31.5	33.0	34.5	36.0	37.5	39.0	40.5	42.0	43.5	45.0	46.5	48.0	49.5	51.0	
Maximum speed (mm/s)	Lead 40						1900	1660	1480	1300	1180	1080	980	880	820	740	680
	Lead 20						950	830	740	650	590	540	490	440	410	370	340

Applicable Controller Specifications

Applicable controller	Maximum number of controlled axes	Compatible encoder type	Program operation	Positioner operation	Pulse-train control	Supply voltage	Page
X-SEL	4 axes	Absolute/Incremental	○	△	×	AC100/200V	
E-Con	1 axis	Absolute/Incremental	×	○	×	AC100/200V	
P-Driver	1 axis	Incremental	×	×	○	AC100/200V	

Caution

(Note 1) The strokes that are set in increments of 50 mm are semi-standard settings.
 (Note 2) Refer to page 40 for the relationship of acceleration and load capacity.
 (Notes 3, 4, 5) The figures in brackets apply to the ISPA Series.
 Other specification values apply to both the ISA and ISPA Series.
 (Note 6) The maximum cable length is 30 m. Specify the desired length in meters (e.g., X08 = 8 m).

* Refer to page 9 for other points to note.

ISA-LXUWX-200

Single-Axis Robot: Large X-Axis Mid-Support, Double Slider Type, Actuator Width 150mm, 200W, Straight Shape

ISPA-LXUWX-200

Single-Axis Robot: Large X-Axis Mid-Support, Double Slider Type, Actuator Width 150mm, 200W, Straight Shape **High-Precision Specification**

Type	Large X-axis (150-mm wide) mid-support, double slider type	Stroke	1000 ~ 2500mm	Load capacity	40kg (horizontal)
------	--	--------	---------------	---------------	-------------------

Model specification items	Series	Type	Encoder type	Motor output	Lead	Stroke	Applicable controller	Cable length	Options						
	ISA[ISPA]	- LXUMX -	A	-	200	-	20	-	2500	-	T1	-	S	-	NM

* Refer to page 11 for the details of model specification items.



Models/Specifications

Model	Encoder type	Motor output (W)	Lead (mm)	Stroke (mm) In increments of 100mm	Speed (Note 1) (mm/s)	Acceleration (Note 2)		Load capacity (Note 2)		Rated thrust (N)
						Horizontal (G)		Vertical (kg)		
						Rated	Maximum	Rated	Maximum	
ISA [ISPA] -LXUWX-A-200-20-***-T1-△-□	Absolute	200	20	1000 ~ 2500	1 ~ 1000	0.3	Horizontal application only	40	Horizontal application only	170.5
ISA [ISPA] -LXUWX-I-200-20-***-T1-△-□	Incremental		20		1 ~ 1000	0.3		40		170.5

* In the above model names, *** indicates the stroke, △ the cable length and □ the applicable options.

*1.0G=9800mm/sec²

Options

Name	Code	Page	Name	Code	Page
AQ seal	AQ	P13	Master-axis designation	LM	P14
Brake	B	P13	Master-axis designation (sensor on opposite side)	LLM	P14
Creep sensor	C	P13	Reverse homing specification	NM	P14
Creep sensor on opposite side	CL	P13	Guide with ball-retaining mechanism	RT	P14
Home limit switch	L	P14	Slave-axis designation	S	P14
Home limit switch on opposite side	LL	P14			

Common Specifications

* Refer to page 10 for the details of common specification items.

Positioning repeatability (Note 3)	±0.02mm [±0.01mm]
Drive system (Note 4)	Ball screw ø20mm, rolled C10 [equivalent to rolled C5]
Lost motion (Note 5)	0.05mm or less [0.02mm or less]
Guide	integrated with base
Allowable static moment	Refer to page 242
Allowable dynamic moment	Ma: 179.3N•m Mb: 254.8N•m Mc: 247.0N•m
Overhang load length	Ma direction: 1250mm or less, Mb/Mc directions: 1250mm or less
Base	Material: Aluminum, with white alumite treatment
Cable length (Note 6)	N: None, S: 3m, M: 5m, X□: Specified length
Ambient operating temperature/humidity	0 to 40°C, 85%RH max. (non-condensing)

Dimensions

* Note that changing the home direction will require the actuator to be returned to IAI for adjustment.

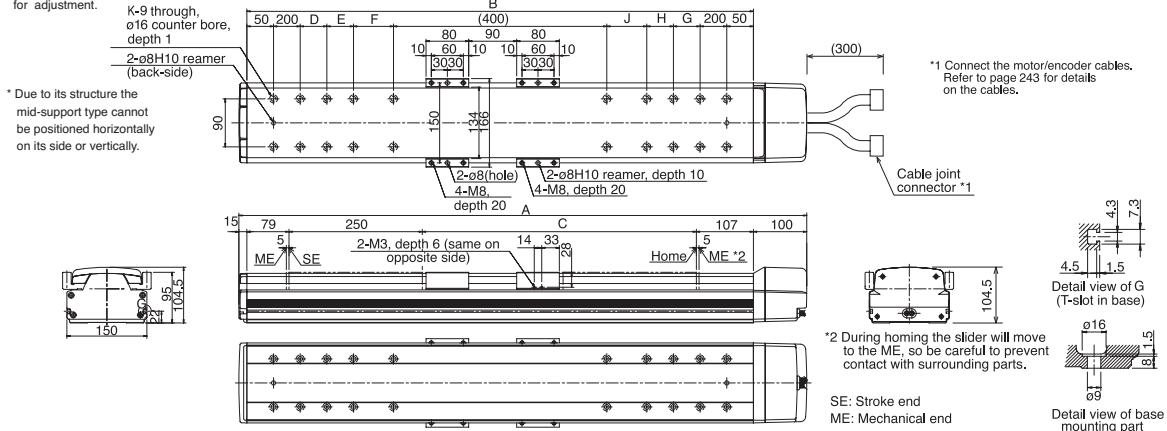

Dimensions, Weight and Maximum Speed by Stroke

Stroke	1000	1100	1200	1300	1400	1500	1600	1700	1800	1900	2000	2100	2200	2300	2400	2500
A	1565	1665	1765	1865	1965	2065	2165	2265	2365	2465	2565	2665	2765	2865	2965	3065
B	1450	1550	1650	1750	1850	1950	2050	2150	2250	2350	2450	2550	2650	2750	2850	2950
C	1014	1114	1214	1314	1414	1514	1614	1714	1814	1914	2014	2114	2214	2314	2414	2514
D	275	325	375	425	475	525	575	200	200	200	200	200	200	200	200	200
E	0	0	0	0	0	0	0	425	475	525	575	200	200	200	200	200
F	0	0	0	0	0	0	0	0	0	0	0	425	475	525	575	625
G	275	325	375	425	475	525	575	200	200	200	200	200	200	200	200	200
H	0	0	0	0	0	0	0	425	475	525	575	200	200	200	200	200
J	0	0	0	0	0	0	0	0	0	0	0	425	475	525	575	625
K	12	12	12	12	12	12	12	16	16	16	16	20	20	20	20	20
Weight (kg)	29.0	30.5	32.0	33.5	35.0	36.5	38.0	39.5	41.0	42.5	44.0	45.5	47.0	48.5	50.0	51.5
Maximum speed (mm/s)	1000			950												

Applicable Controller Specifications

Applicable controller	Maximum number of controlled axes	Compatible encoder type	Program operation	Positioner operation	Pulse-train control	Supply voltage	Page
X-SEL	4 axes	Absolute/incremental	○	△	×	AC100/200V	
E-Con	1 axis	Absolute/incremental	×	○	×	AC100/200V	
P-Driver	1 axis	Incremental	×	×	○	AC100/200V	



(Note 1) The strokes that are set in increments of 50 mm are semi-standard settings.
 (Note 2) Refer to page 40 for the relationship of acceleration and load capacity.
 (Notes 3, 4, 5) The figures in brackets apply to the ISPA Series.
 Other specification values apply to both the ISA and ISPA Series.
 (Note 6) The maximum cable length is 30 m. Specify the desired length in meters (e.g., X08 = 8 m).

* Refer to page 9 for other points to note.

ISA-LXUWX-400

Single-Axis Robot: Large X-Axis Mid-Support, Double Slider Type, Actuator Width 150mm, 400W, Straight Shape

ISPA-LXUWX-400

Single-Axis Robot: Large X-Axis Mid-Support, Double Slider Type, Actuator Width 150mm, 400W, Straight Shape High-Precision Specification

Type	Large X-axis (150-mm wide) mid-support, double slider type	Stroke	1000 ~ 2500mm	Load capacity	80kg (horizontal)
Model specification items Series Type Encoder type Motor output Lead Stroke Applicable controller Cable length Options ISA[ISPA] - LXUWX - A - 400 - 40 - 2500 - T1 - S - NM					

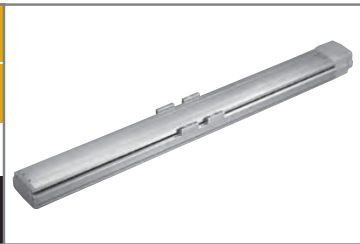

Single-Axis Robots

Cartesian Robots

* Refer to page 11 for the details of model specification items.

Models/Specifications

Model	Encoder type	Motor output (W)	Lead (mm)	Stroke (mm) In increments of 100mm	Speed (Note 1) (mm/s)	Acceleration (Note 2)				Load capacity (Note 2)				Rated thrust (N)
						Horizontal (G)		Vertical (G)		Horizontal (kg)		Vertical (kg)		
						Rated	Maximum	Rated	Maximum	Rated	Maximum	Rated	Maximum	
ISA [ISPA] -LXUWX-A-400-40-***-T1-Δ□	Absolute	400	40	1000 ~ 2500	1 ~ 2000	0.3		Horizontal application only		40		Horizontal application only		170.0
ISA [ISPA] -LXUWX-A-400-20-***-T1-Δ□			20		1 ~ 1000	0.3		80		340.1				
ISA [ISPA] -LXUWX-I-400-40-***-T1-Δ□	Incremental	400	40	1000 ~ 2500	1 ~ 2000	0.3		Horizontal application only		40		Horizontal application only		170.0
ISA [ISPA] -LXUWX-I-400-20-***-T1-Δ□			20		1 ~ 1000	0.3		80		340.1				

* In the above model names, *** indicates the stroke, Δ the cable length and □ the applicable options.

*1.0G=9800mm/sec²

Options

Name	Code	Page	Name	Code	Page
AQ seal	AQ	P13	Master-axis designation	LM	P14
Brake	B	P13	Master-axis designation (sensor on opposite side)	LLM	P14
Creep sensor	C	P13	Reverse homing specification	NM	P14
Creep sensor on opposite side	CL	P13	Guide with ball-retaining mechanism	RT	P14
Home limit switch	L	P14	Slave-axis designation	S	P14
Home limit switch on opposite side	LL	P14			

Common Specifications

* Refer to page 10 for the details of common specification items.

Positioning repeatability (Note 3)	±0.02mm [±0.01mm]
Drive system (Note 4)	Ball screw ø20mm, rolled C10 [equivalent to rolled C5]
Lost motion (Note 5)	0.05mm or less [0.02mm or less]
Guide	integrated with base
Allowable static moment	Refer to page 242
Allowable dynamic moment	Ma: 179.3N•m Mb: 254.8N•m Mc: 247.0N•m
Overhang load length	Ma direction: 1250mm or less, Mb/Mc directions: 1250mm or less
Base	Material: Aluminum, with white alumite treatment
Cable length (Note 6)	N: None, S: 3m, M: 5m, X□□: Specified length
Ambient operating temperature/humidity	0 to 40°C, 85%RH max. (non-condensing)

Dimensions

* Note that changing the home direction will require the actuator to be returned to |A| for adjustment.

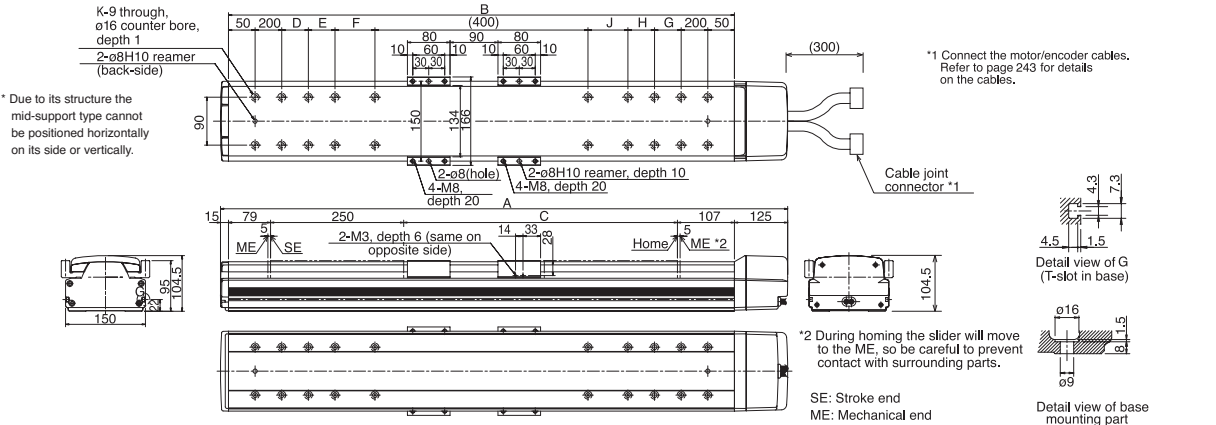

Dimensions, Weight and Maximum Speed by Stroke

Stroke	1000	1100	1200	1300	1400	1500	1600	1700	1800	1900	2000	2100	2200	2300	2400	2500	
A	1590	1690	1790	1890	1990	2090	2190	2290	2390	2490	2590	2690	2790	2890	2990	3090	
B	1450	1550	1650	1750	1850	1950	2050	2150	2250	2350	2450	2550	2650	2750	2850	2950	
C	1014	1114	1214	1314	1414	1514	1614	1714	1814	1914	2014	2114	2214	2314	2414	2514	
D	275	325	375	425	475	525	575	200	200	200	200	200	200	200	200	200	
E	0	0	0	0	0	0	0	425	475	525	575	200	200	200	200	200	
F	0	0	0	0	0	0	0	0	0	0	0	425	475	525	575	625	
G	275	325	375	425	475	525	575	200	200	200	200	200	200	200	200	200	
H	0	0	0	0	0	0	0	425	475	525	575	200	200	200	200	200	
J	0	0	0	0	0	0	0	0	0	0	0	425	475	525	575	625	
K	12	12	12	12	12	12	12	16	16	16	16	20	20	20	20	20	
Weight (kg)	30.0	31.5	33.0	34.5	36.0	37.5	39.0	40.5	42.0	43.5	45.0	46.5	48.0	49.5	51.0	52.5	
Maximum speed (mm/s)	Lead 40	2000					1900	1660	1480	1300	1180	1080	990	880	820	740	680
	Lead 20	1000					950	830	740	650	590	540	490	440	410	370	340

Applicable Controller Specifications

Applicable controller	Maximum number of controlled axes	Compatible encoder type	Program operation	Positioner operation	Pulse-train control	Supply voltage	Page
X-SEL	4 axes	Absolute/Incremental	○	△	×	AC100/200V	
E-Con	1 axis	Absolute/Incremental	×	○	×	AC100/200V	
P-Driver	1 axis	Incremental	×	×	○	AC100/200V	

Caution

(Note 1) The strokes that are set in increments of 50 mm are semi-standard settings.
 (Note 2) Refer to page 40 for the relationship of acceleration and load capacity.
 (Notes 3, 4, 5) The figures in brackets apply to the ISPA Series.
 Other specification values apply to both the ISA and ISPA Series.
 (Note 6) The maximum cable length is 30 m. Specify the desired length in meters (e.g., X08 = 8 m).

* Refer to page 9 for other points to note.

ISA-LYM-200 Single-Axis Robot: Large Y-Axis Long Slider Type, Actuator Width 150mm, 200W, Straight Shape

ISPA-LYM-200 Single-Axis Robot: Large Y-Axis Long Slider Type, Actuator Width 150mm, 200W, Straight Shape **High-Precision Specification**

Type Large Y-axis (150-mm wide) long slider type Stroke 100 ~ 1200mm Load capacity 80kg (horizontal)/19kg (vertical)

Model specification items — Series — Type — Encoder type — Motor output — Lead — Stroke — Applicable controller — Cable length — Options

ISA[ISPA] – LYM – A – 200 – 20 – 1200 – T1 – S – NM

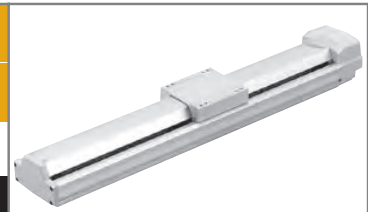

* Refer to page 11 for the details of model specification items.

Models/Specifications

Model	Encoder type	Motor output (W)	Lead (mm)	Stroke (mm) In increments of 50mm (Note 1)	Speed (Note 2) (mm/s)	Acceleration (Note 3)				Load capacity (Note 3)				Rated thrust (N)
						Horizontal (G)		Vertical (G)		Horizontal (kg)		Vertical (kg)		
						Rated	Maximum	Rated	Maximum	Rated	Maximum	Rated	Maximum	
ISA [ISPA] -LYM-A-200-20-***-T1-△-□	Absolute	200	20	100 ~ 1200	1 ~ 1000	0.3	1.0	0.3	0.8	40	12	9	4	170.5
ISA [ISPA] -LYM-A-200-10-***-T1-△-□			1 ~ 500		0.3	0.6	0.3	0.5	80	40	19	14	340.1	
ISA [ISPA] -LYM-I-200-20-***-T1-△-□	Incremental		10		1 ~ 1000	0.3	1.0	0.3	0.8	40	12	9	4	170.5
ISA [ISPA] -LYM-I-200-10-***-T1-△-□			10		1 ~ 500	0.3	0.6	0.3	0.5	80	40	19	14	340.1

* In the above model names, *** indicates the stroke, △ the cable length and □ the applicable options. + 1.0G=9800mm/sec²

Options

Name	Code	Page	Name	Code	Page
AQ seal	AQ	P13	Master-axis designation	LM	P14
Brake	B	P13	Master-axis designation (sensor on opposite side)	LLM	P14
Creep sensor	C	P13	Reverse homing specification	NM	P14
Creep sensor on opposite side	CL	P13	Guide with ball-retaining mechanism	RT	P14
Home limit switch	L	P14	Slave-axis designation	S	P14
Home limit switch on opposite side	LL	P14			

Common Specifications

* Refer to page 10 for the details of common specification items.

Positioning repeatability (Note 4)	±0.02mm [±0.01mm]
Drive system (Note 5)	Ball screw ø20mm, rolled C10 [equivalent to rolled C5]
Lost motion (Note 6)	0.05mm or less [0.02mm or less]
Guide	integrated with base
Allowable static moment	Refer to page 242
Allowable dynamic moment	Ma: 104.9N•m Mb: 149.9N•m Mc: 124.5N•m
Overhang load length	Ma direction: 750mm or less, Mb/Mc directions: 750mm or less
Base	Material: Aluminum, with white alumite treatment
Cable length (Note 7)	N: None, S: 3m, M: 5m, X□□: Specified length
Ambient operating temperature/humidity	0 to 40°C, 85%RH max. (non-condensing)

Dimensions

* Note that changing the home direction will require the actuator to be returned to IA1 for adjustment.

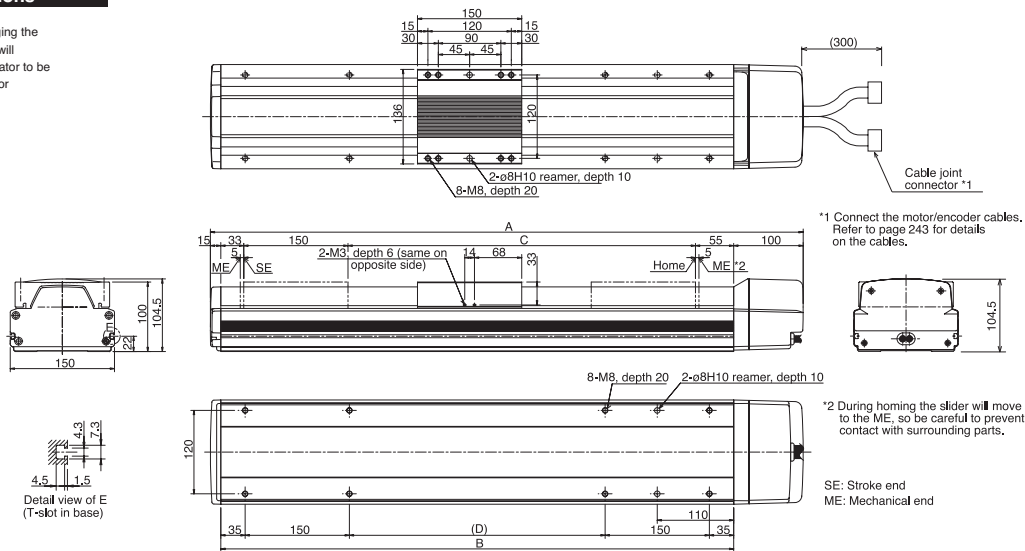

Dimensions, Weight and Maximum Speed by Stroke

Stroke	100	(150)	200	(250)	300	(350)	400	(450)	500	(550)	600	(650)	700	(750)	800	(850)	900	(950)	1000	(1050)	1100	(1150)	1200
A	453	503	553	603	653	703	753	803	853	903	953	1003	1053	1103	1153	1203	1253	1303	1353	1403	1453	1503	1553
B	338	388	438	488	538	588	638	688	738	788	838	888	938	988	1038	1088	1138	1188	1238	1288	1338	1388	1438
C	100	150	200	250	300	350	400	450	500	550	600	650	700	750	800	850	900	950	1000	1050	1100	1150	1200
D	0	0	1	1	1	1	2	2	2	2	3	3	3	3	4	4	4	4	5	5	5	5	6
Weight (kg)	11.0	11.8	12.5	12.3	14.1	14.9	15.7	16.5	17.3	18.1	18.8	19.6	20.4	21.2	22.0	22.8	23.5	24.3	25.1	25.9	26.7	27.5	28.2
Maximum speed (mm/s)	Lead 20	1000											1000		830		690		585		500		
	Lead 10	500											470		385		320		270		235		

Applicable Controller Specifications

Applicable controller	Maximum number of controlled axes	Compatible encoder type	Program operation	Positioner operation	Pulse-train control	Supply voltage	Page
X-SEL	4 axes	Absolute/incremental	○	△	×	AC100/200V	
E-Con	1 axis	Absolute/incremental	×	○	×	AC100/200V	
P-Driver	1 axis	Incremental	×	×	○	AC100/200V	

Caution

(Note 1) The strokes that are set in increments of 50 mm are semi-standard settings.
 (Note 2) A longer stroke will result in a lower maximum speed to prevent the ball screw from reaching a dangerous speed. (Refer to the above table for the maximum speed at a given stroke.)
 (Note 3) Refer to page 40 for the relationship of acceleration and load capacity. (Notes 4, 5, 6) The figures in brackets apply to the ISPA Series.
 Other specification values apply to both the ISA and ISPA Series.
 (Note 7) The maximum cable length is 30 m. Specify the desired length in meters (e.g., X08 = 8 m).

* Refer to page 9 for other points to note.

ISA-LYM-400 Single-Axis Robot: Large Y-Axis Long Slider Type, Actuator Width 150mm, 400W, Straight Shape
ISPA-LYM-400 Single-Axis Robot: Large Y-Axis Long Slider Type, Actuator Width 150mm, 400W, Straight Shape High-Precision Specification



Type Large Y-axis (150-mm wide) long slider type Stroke 100 ~ 1200mm Load capacity 80kg (horizontal)/19kg (vertical)

Model specification items Series Type Encoder type Motor output Lead Stroke Applicable controller Cable length Options
 ISA[ISPA] - LYM - A - 400 - 40 - 1200 - T1 - S - NM

* Refer to page 11 for the details of model specification items.

Models/Specifications

Model	Encoder type	Motor output (W)	Lead (mm)	Stroke (mm) In increments of 50mm (Note 1)	Speed (Note 2) (mm/s)	Acceleration (Note 3)				Load capacity (Note 3)				Rated thrust (N)
						Horizontal (G)		Vertical (G)		Horizontal (kg)		Vertical (kg)		
						Rated	Maximum	Rated	Maximum	Rated	Maximum	Rated	Maximum	
ISA [ISPA] -LYM-A-400-40-***-T1-△-□	Absolute	400	40	100 ~ 1200	1 ~ 2000	0.3	1.0	0.3	1.0	40	15	9	4	170.0
ISA [ISPA] -LYM-A-400-20-***-T1-△-□			20		1 ~ 1000	0.3	1.0	0.3	0.8	80	24	19	10	340.1
ISA [ISPA] -LYM-I-400-40-***-T1-△-□	Incremental	400	40	100 ~ 1200	1 ~ 2000	0.3	1.0	0.3	1.0	40	15	9	4	170.0
ISA [ISPA] -LYM-I-400-20-***-T1-△-□			20		1 ~ 1000	0.3	1.0	0.3	0.8	80	24	19	10	340.1

* In the above model names, *** indicates the stroke, △ the cable length and □ the applicable options.

*1.0 G=9800mm/sec²

Options

Name	Code	Page	Name	Code	Page
AQ seal	AQ	P13	Master-axis designation	LM	P14
Brake	B	P13	Master-axis designation (sensor on opposite side)	LLM	P14
Creep sensor	C	P13	Reverse homing specification	NM	P14
Creep sensor on opposite side	CL	P13	Guide with ball-retaining mechanism	RT	P14
Home limit switch	L	P14	Slave-axis designation	S	P14
Home limit switch on opposite side	LL	P14			

Common Specifications

* Refer to page 10 for the details of common specification items.

Positioning repeatability (Note 4)	±0.02mm [±0.01mm]
Drive system (Note 5)	Ball screw ø20mm, rolled C10 [equivalent to rolled C5]
Lost motion (Note 6)	0.05mm or less [0.02mm or less]
Guide	integrated with base
Allowable static moment	Refer to page 242
Allowable dynamic moment	Ma: 104.9N•m Mb: 149.9N•m Mc: 124.5N•m
Overhang load length	Ma direction: 750mm or less, Mb/Mc directions: 750mm or less
Base	Material: Aluminum, with white alumite treatment
Cable length (Note 7)	N: None, S: 3m, M: 5m, X□□: Specified length
Ambient operating temperature/humidity	0 to 40°C, 85%RH max. (non-condensing)

Dimensions

* Note that changing the home direction will require the actuator to be returned to IAI for adjustment.

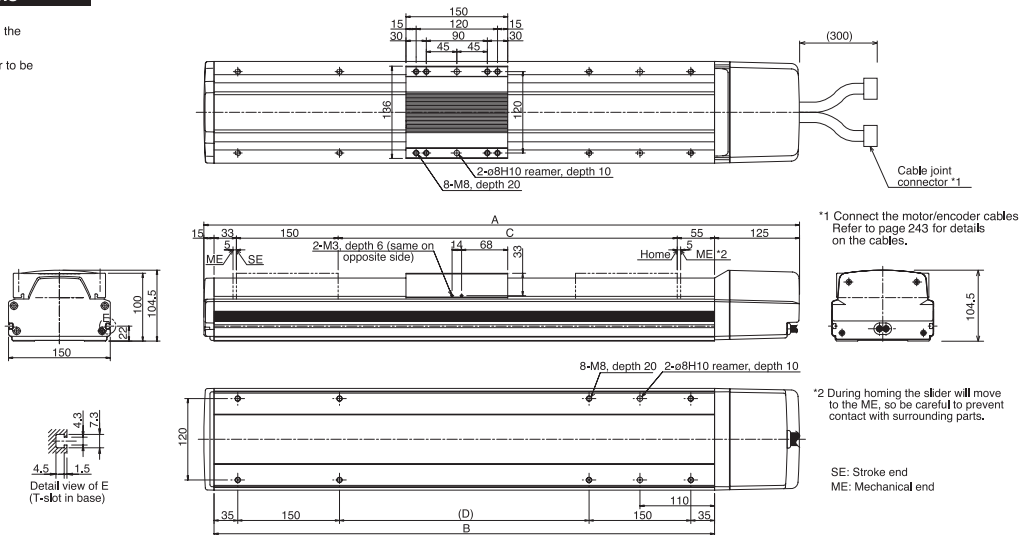

Dimensions, Weight and Maximum Speed by Stroke

Stroke	100	(150)	200	(250)	300	(350)	400	(450)	500	(550)	600	(650)	700	(750)	800	(850)	900	(950)	1000	(1050)	1100	(1150)	1200			
A	478	528	578	628	678	728	778	828	878	928	978	1028	1078	1128	1178	1228	1278	1328	1378	1428	1478	1528	1578			
B	338	388	438	488	538	588	638	688	738	788	838	888	938	988	1038	1088	1138	1188	1238	1288	1338	1388	1438			
C	100	150	200	250	300	350	400	450	500	550	600	650	700	750	800	850	900	950	1000	1050	1100	1150	1200			
D	0	0	1	1	1	1	2	2	2	2	3	3	3	3	4	4	4	4	5	5	5	5	6			
Weight (kg)	12.0	12.8	13.5	14.3	15.1	15.9	16.7	17.5	18.3	19.1	19.8	20.6	21.4	22.2	23.0	23.8	24.5	25.3	26.1	26.9	27.7	28.5	29.2			
Maximum speed (mm/s)	Lead 40																2000		1660		1380		1170		1000	
	Lead 20																1000		830		690		585		500	

Applicable Controller Specifications

Applicable controller	Maximum number of controlled axes	Compatible encoder type	Program operation	Positioner operation	Pulse-train control	Supply voltage	Page
X-SEL	4 axes	Absolute/Incremental	○	△	×	AC100/200V	
E-Con	1 axis	Absolute/Incremental	×	○	×	AC100/200V	
P-Driver	1 axis	Incremental	×	×	○	AC100/200V	

Caution
 (Note 1) The strokes that are set in increments of 50 mm are semi-standard settings.
 (Note 2) A longer stroke will result in a lower maximum speed to prevent the ball screw from reaching a dangerous speed. (Refer to the above table for the maximum speed at a given stroke.)
 (Note 3) Refer to page 40 for the relationship of acceleration and load capacity. (Notes 4, 5, 6) The figures in brackets apply to the ISPA Series.
 Other specification values apply to both the ISA and ISPA Series.
 (Note 7) The maximum cable length is 30 m. Specify the desired length in meters (e.g., X08 = 8 m).

* Refer to page 9 for other points to note.

ISA-LZM-200 Single-Axis Robot: Large Vertical-Axis Long Slider Type, Actuator Width 150mm, 200W, Straight Shape
ISPA-LZM-200 Single-Axis Robot: Large Vertical-Axis Long Slider Type, Actuator Width 150mm, 200W, Straight Shape **High-Precision Specification**



Type	Large vertical-axis (150-mm wide) long slider type	Stroke	100 ~ 1200mm	Vertical application only (with standard brake)	19kg
Model specification items: Series - Type - Encoder type - Motor output - Lead - Stroke - Applicable controller - Cable length - Options					
ISA[ISPA] - LZM - I - 200 - 10 - 1200 - T1 - S - B - L					

* Refer to page 11 for the details of model specification items.

Models/Specifications

Model	Encoder type	Motor output (W)	Lead (mm)	Stroke (mm) In increments of 50mm (Note 1)	Speed (Note 2) (mm/s)	Acceleration (Note 3)				Load capacity (Note 3)				Rated thrust (N)
						Horizontal (G)		Vertical (G)		Horizontal (kg)		Vertical (kg)		
						Rated	Maximum	Rated	Maximum	Rated	Maximum	Rated	Maximum	
ISA [ISPA] -LZM-A-200-10-***-T1-Δ-B-□	Absolute	200	10	100 ~ 1200	1 ~ 500	Vertical application only		0.3	0.5	Vertical application only		19	14	340.1
ISA [ISPA] -LZM-I-200-10-***-T1-Δ-B-□	Incremental		10		1 ~ 500	0.3	0.5	19	14					

* In the above model names, *** indicates the stroke, Δ the cable length and □ the applicable options.

*1.0G=9800mm/sec²

Options

Name	Code	Page	Name	Code	Page
AQ seal	AQ	P13	Master-axis designation	LM	P14
Brake	B	P13	Master-axis designation (sensor on opposite side)	LLM	P14
Creep sensor	C	P13	Reverse homing specification	NM	P14
Creep sensor on opposite side	CL	P13	Guide with ball-retaining mechanism	RT	P14
Home limit switch	L	P14	Slave-axis designation	S	P14
Home limit switch on opposite side	LL	P14			

* The MZM type comes standard with a brake (B).

Common Specifications

* Refer to page 10 for the details of common specification items.

Positioning repeatability (Note 4)	±0.02mm [±0.01mm]
Drive system (Note 5)	Ball screw ø16mm, rolled C10 [equivalent to rolled C5]
Lost motion (Note 6)	0.05mm or less [0.02mm or less]
Guide	integrated with base
Allowable static moment	Refer to page 242
Allowable dynamic moment	Ma: 104.9N·m Mb: 149.9N·m Mc: 124.5N·m
Brake	Comes standard with a dry, single-plate, non-excitation type electromagnetic brake
Base	Material: Aluminum, with white alumite treatment
Cable length (Note 7)	N: None, S: 3m, M: 5m, X□□: Specified length
Ambient operating temperature/humidity	0 to 40°C, 85%RH max. (non-condensing)

Dimensions

* Note that changing the home direction will require the actuator to be returned to IAI for adjustment.

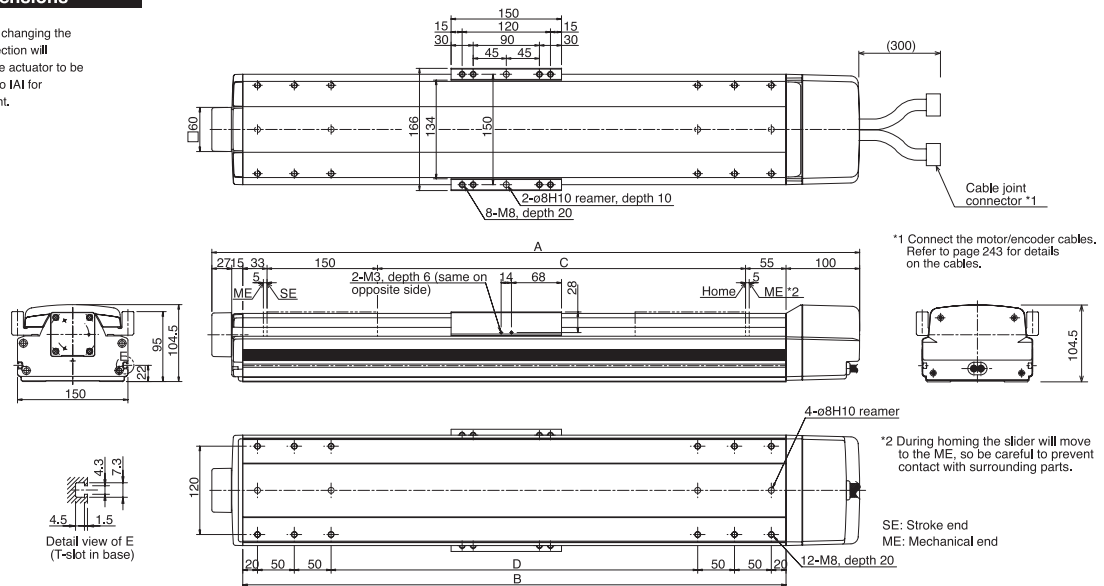

*1 Connect the motor/encoder cables. Refer to page 243 for details on the cables.

*2 During homing the slider will move to the ME, so be careful to prevent contact with surrounding parts.

Dimensions, Weight and Maximum Speed by Stroke

Stroke	100	(150)	200	(250)	300	(350)	400	(450)	500	(550)	600	700	800	900	1000	1100	1200
A	480	530	580	630	680	730	780	830	880	930	980	Use the base of the LZM type for 700 and longer strokes. Refer to the drawing on page 25 for the mounting dimensions.					
B	338	388	438	488	538	588	638	688	738	788	838						
C	100	150	200	250	300	350	400	450	500	550	600						
D	98	148	198	248	298	348	398	448	498	548	598						
Weight (kg)	12.4	13.2	13.9	14.7	15.5	16.3	17.1	17.9	18.7	19.5	20.2	21.8	23.4	24.9	26.5	28.1	29.6
Maximum speed (mm/s)	500											500	470	385	320	270	235

Applicable Controller Specifications

Applicable controller	Maximum number of controlled axes	Compatible encoder type	Program operation	Positioner operation	Pulse-train control	Supply voltage	Page
X-SEL	4 axes	Absolute/Incremental	○	△	×	AC100/200V	
E-Con	1 axis	Absolute/Incremental	×	○	×	AC100/200V	
P-Driver	1 axis	Incremental	×	×	○	AC100/200V	

Caution

(Note 1) The strokes that are set in increments of 50 mm are semi-standard settings.
 (Note 2) A longer stroke will result in a lower maximum speed to prevent the ball screw from reaching a dangerous speed. (Refer to the above table for the maximum speed at a given stroke.)
 (Note 3) Refer to page 40 for the relationship of acceleration and load capacity. (Notes 4, 5, 6) The figures in brackets apply to the ISPA Series. Other specification values apply to both the ISA and ISPA Series.
 (Note 7) The maximum cable length is 30 m. Specify the desired length in meters (e.g. X08 = 8 m).

* Refer to page 9 for other points to note.

* The LZM type comes standard with a brake, so use a controller of brake specification.

ISA-LZM-400 Single-Axis Robot: Large Vertical-Axis Long Slider Type, Actuator Width 150mm, 400W, Straight Shape
ISPA-LZM-400 Single-Axis Robot: Large Vertical-Axis Long Slider Type, Actuator Width 150mm, 400W, Straight Shape High-Precision Specification



Type Large vertical-axis (150-mm wide) long slider type Stroke 100 ~ 1200mm Vertical application only (with standard brake) 39kg

Model specification items Series Type Encoder type Motor output Lead Stroke Applicable controller Cable length Options
 ISA[ISPA] - LZM - I - 400 - 10 - 1200 - T1 - S - B - L

* Refer to page 11 for the details of model specification items.

Models/Specifications

Model	Encoder type	Motor output (W)	Lead (mm)	Stroke (mm) In increments of 50mm (Note 1)	Speed (Note 2) (mm/s)	Acceleration (Note 3)				Load capacity (Note 3)		Rated thrust (N)		
						Horizontal (G)		Vertical (G)		Horizontal (kg)			Vertical (kg)	
						Rated	Maximum	Rated	Maximum	Rated	Maximum		Rated	Maximum
ISA [ISPA] -LZM-A-400-10-***-T1-Δ-B-□	Absolute	400	10	100 ~ 1200	1 ~ 500	Vertical application only		0.3	0.5	Vertical application only		680.2		
ISA [ISPA] -LZM-H-400-10-***-T1-Δ-B-□	Incremental		10		1 ~ 500	Vertical application only		0.3	0.5	39	28			

* In the above model names, *** indicates the stroke, Δ the cable length and □ the applicable options.

*1.0G=9800mm/sec²

Options

Name	Code	Page	Name	Code	Page
AQ seal	AQ	P13	Master-axis designation	LM	P14
Brake	B	P13	Master-axis designation (sensor on opposite side)	LLM	P14
Creep sensor	C	P13	Reverse homing specification	NM	P14
Creep sensor on opposite side	CL	P13	Guide with ball-retaining mechanism	RT	P14
Home limit switch	L	P14	Slave-axis designation	S	P14
Home limit switch on opposite side	LL	P14			

* The MZM type comes standard with a brake (B).

Common Specifications

* Refer to page 10 for the details of common specification items.

Positioning repeatability (Note 4)	±0.02mm [±0.01mm]
Drive system (Note 5)	Ball screw ø20mm, rolled C10 [equivalent to rolled C5]
Lost motion (Note 6)	0.05mm or less [0.02mm or less]
Guide	integrated with base
Allowable static moment	Refer to page 242
Allowable dynamic moment	Ma: 104.9N•m Mb: 149.9N•m Mc: 124.5N•m
Brake	Comes standard with a dry, single-plate, non-excitation type electromagnetic brake
Base	Material: Aluminum, with white alumite treatment
Cable length (Note 7)	N: None, S: 3m, M: 5m, X□□: Specified length
Ambient operating temperature/humidity	0 to 40°C, 85%RH max. (non-condensing)

Dimensions

* Note that changing the home direction will require the actuator to be returned to IAI for adjustment.

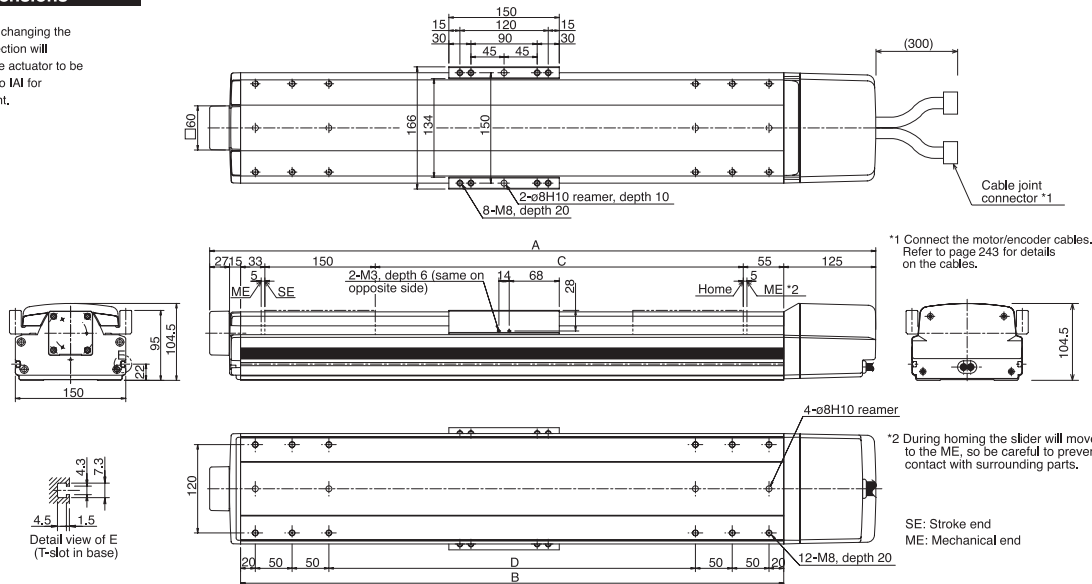

Dimensions, Weight and Maximum Speed by Stroke

Stroke	100	(150)	200	(250)	300	(350)	400	(450)	500	(550)	600	700	800	900	1000	1100	1200
A	505	555	605	655	705	755	805	855	905	955	1005	Use the base of the LZM type for 700 and longer strokes. Refer to the drawing on page 26 for the mounting dimensions.					
B	338	388	438	488	538	588	638	688	738	788	838						
C	100	150	200	250	300	350	400	450	500	550	600						
D	98	148	198	248	298	348	398	448	498	548	598						
Weight (kg)	12.4	13.2	13.9	14.7	15.5	16.3	17.1	17.9	18.7	19.5	20.2	21.8	23.4	24.9	26.5	28.1	29.6
Max. speed (mm/s)	500											500	470	385	320	270	235

Applicable Controller Specifications

Applicable controller	Maximum number of controlled axes	Compatible encoder type	Program operation	Positioner operation	Pulse-train control	Supply voltage	Page
X-SEL	4 axes	Absolute/Incremental	○	△	×	AC100/200V	
E-Con	1 axis	Absolute/Incremental	×	○	×	AC100/200V	
P-Driver	1 axis	Incremental	×	×	○	AC100/200V	

* The LZM type comes standard with a brake, so use a controller of brake specification.

Caution

(Note 1) The strokes that are set in increments of 50 mm are semi-standard settings.
 (Note 2) A longer stroke will result in a lower maximum speed to prevent the ball screw from reaching a dangerous speed. (Refer to the above table for the maximum speed at a given stroke.)
 (Note 3) Refer to page 40 for the relationship of acceleration and load capacity. (Notes 4, 5, 6) The figures in brackets apply to the ISPA Series. Other specification values apply to both the ISA and ISPA Series.
 (Note 7) The maximum cable length is 30 m. Specify the desired length in meters (e.g., X08 = 8 m).

* Refer to page 9 for other points to note.

ISA-WXM-600

Single-Axis Robot: Super-Large X-Axis Type, Actuator Width 198mm, 600W. Straight Shape

ISPA-WXM-600

Single-Axis Robot: Super-Large X-Axis Type, Actuator Width 198mm, 600W. Straight Shape High-Precision Specification



Model specification items	Series	WXM Type	Encoder type	Motor Output	Lead	Stroke	Applicable controller	Cable length	Options
ISA: Standard Specification ISPA: High-Precision Specification			A: Absolute I: Incremental	600:600W	40:40mm 20:20mm 10:10mm	100:100mm 1300:1300mm (every 100mm)	T1: XSEL-J/K T2: SCON SSEL XSEL-P/Q	N: None S: 3 m M: 5 m X: Length specification	Refer to the option list below.

* Refer to page 11 for the details of model specification items.

Models/Specifications

Model	Encoder type	Motor output (W)	Lead (mm)	Stroke (mm) In increments of 100mm	Speed (Note 1) (mm/s)	Acceleration (Note 2)				Load capacity (Note 2)				Rated thrust (N)
						Horizontal (G)		Vertical (G)		Horizontal (G)		Vertical (G)		
						Rated	Maximum	Rated	Maximum	Rated acceleration	Maximum acceleration	Rated	Maximum	
ISA[ISPA]-WXM-①-600-40-②-③-④-L-⑤	Absolute Incremental	600	40	100 ~ 1300	1 ~ 2400	0.3	1.0	0.3	1.0	60	18	14	5	255
ISA[ISPA]-WXM-①-600-20-②-③-④-L-⑤			1 ~ 1200		0.3	1.0	0.3	0.8	120	36	29	15	510	
ISA[ISPA]-WXM-①-600-10-②-③-④-L-⑤			1 ~ 600		0.3	0.6	0.3	0.5	150	75	60	40	1020	

* In the above model names, ① indicates the encoder type, ② stroke, ③ applicable controller, ④ cable length and ⑤ options.

Options

Name	Code	Page	Name	Code	Page
AQ seal	AQ	→P13	Master-axis designation	LM	→P14
Brake	B	→P13	Reverse homing specification	NM	→P14
Creep sensor	C	→P13	Slave-axis designation	S	→P14
Home limit switch	L	→P14	Optional cable exit direction	A1/A3	Refer to the figure below

* With the WXM type, the home limit switch (L) is a standard equipment.

Common Specifications

Positioning repeatability (Note 3)	± 0.02 mm [± 0.01 mm]
Drive system (Note 4)	Ball screw ø20 mm, rolled C10 [equivalent to C5]
Lost motion (Note 5)	0.05 mm or less [0.02 mm or less]
Allowable static moment	Refer to page 242
Allowable dynamic moment (Note 6)	Ma: 139.2 N · m Mb: 199.9 N · m Mc: 391 N · m
Overhang load length	Ma direction: 900 mm or less, Mb/Mc directions: 900 mm or less
Base	Material: Aluminum with white alumite treatment
Applicable controller	T1: XSEL-J/K T2: XSEL-P/Q, SSEL, SCON
Cable length (Note 7)	N: No cable, S: 3 m, M: 5 m, X: Length specification
Ambient operating temperature · humidity	0 to 40°C, 85% RH or less (Non-condensing)

Dimensions

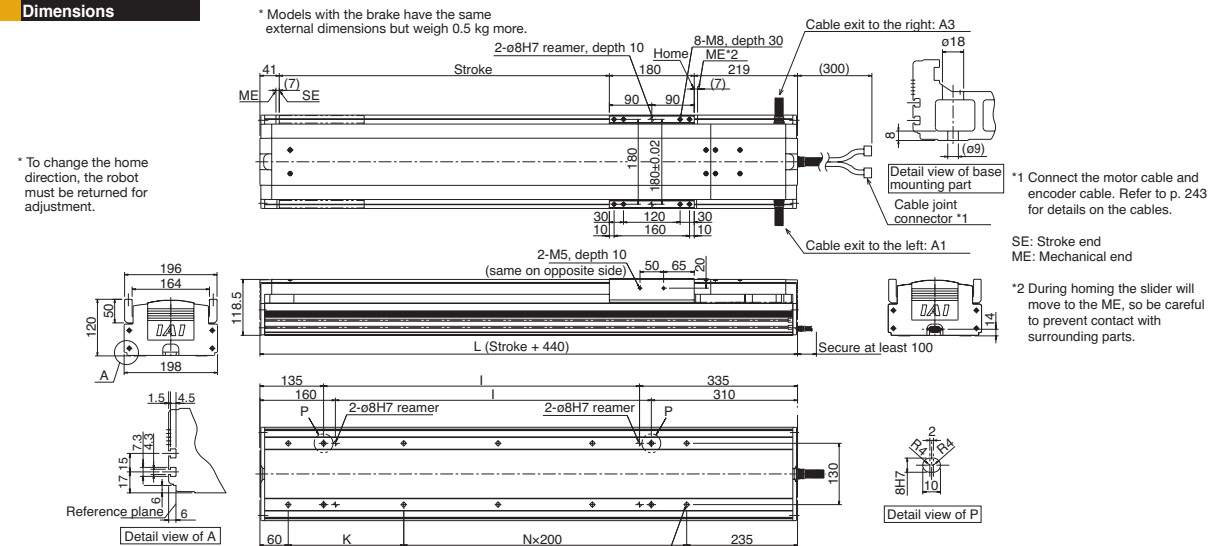

Dimensions, Weight and Maximum Speed by Stroke

Stroke	100	200	300	400	500	600	700	800	900	1000	1100	1200	1300
L	540	640	740	840	940	1040	1140	1240	1340	1440	1540	1640	1740
I	70	170	270	370	470	570	670	770	870	970	1070	1170	1270
K	245	145	245	145	245	145	245	145	245	145	245	145	245
N	-	1	1	2	2	3	3	4	4	5	5	6	6
m	4	6	6	8	8	10	10	12	12	14	14	16	16
Weight (kg)	18.1	20.1	22.1	24.1	26.1	28.0	30.0	32.0	34.0	35.9	37.9	39.9	41.9
Maximum speed (mm/s) * Varies depending on the stroke.	Lead 40	2400											
	Lead 20	1200											
	Lead 10	600											
									1840	1530	1290	1100	950
									920	765	645	550	475
									460	380	320	270	235

Applicable Controller Specifications

Applicable controller	Maximum number of controlled axes	Compatible encoder type	Operating method	Supply voltage	Page
X-SEL-P/Q	6 axes	Absolute/Incremental	Program	Single phase/ Three-phase 200VAC	
X-SEL-K	4 axes			Single phase AC 100/200V	
X-SEL-J (Note 8)	4 axes			Single phase AC 200V	
SSEL	2 axes				
SCON	1 axis		Positioner pulse train control		

Caution

(Note 1) A longer stroke will result in a lower maximum speed to prevent the ball screw from reaching a dangerous speed. (Refer to the above table for the maximum speed at a given stroke.)

(Note 2) Refer to page 40 for the relationship of acceleration and payload. (Note 3,4,5) The figures in brackets apply to the ISPA Series. Other specification values apply to both the ISA and ISPA Series

(Note 6) Traveling life of 10,000 km is assumed.

(Note 7) The maximum cable length is 30 m. Specify the desired length in meters (e.g. X08 = 8 m)

(Note 8) If the WXM type is to be used vertically, use a controller other than the XSEL-J type.

* The WXM type comes with the home limit switch as a standard equipment, so use a controller of limit switch specification for this type.

ISA-WXM-750

Single-Axis Robot: Super-Large X-Axis Type, Actuator Width 198mm, 750W. Straight Shape

ISPA-WXM-750

Single-Axis Robot: Super-Large X-Axis Type, Actuator Width 198mm, 750W. Straight Shape High-Precision Specification



Model specification items	Series	WXM Type	Encoder type	750 Motor Output	Lead	Stroke	Applicable controller	Cable length	Options
ISA: Standard Specification ISPA: High-Precision Specification	Standard High-Precision		A: Absolute I: Incremental	750:750W	50:50mm 25:25mm	100:100mm 1300:1300mm (every 100mm)	T1:XSEL-J/K T2:SCON SSEL XSEL-P/Q	N:None S:3 m M:5 m X□□: Length specification	Refer to the option list below.

* Refer to page 11 for the details of model specification items.

Models/Specifications

Model	Encoder type	Motor output (W)	Lead (mm)	Stroke(mm) In increments of 100mm	Speed (Note1) (mm/s)	Acceleration (Note 2)				Load capacity (Note 2)				Rated thrust (N)
						Horizontal (G)		Vertical (G)		Horizontal (G)		Vertical (G)		
						Rated	Maximum	Rated	Maximum	Rated acceleration	Maximum acceleration	Rated acceleration	Maximum acceleration	
ISA[ISPA]-WXM-①-750-50-②-③-④-L-⑤	Absolute Incremental	750	50	100 ~ 1300	1 ~ 2000	0.3	1.0	0.3	1.0	60	18	14	5	255
ISA[ISPA]-WXM-①-750-25-②-③-④-L-⑤			25		1 ~ 1250	0.3	1.0	0.3	0.8	120	36	29	15	510

* In the above model names, ① indicates the encoder type, ② stroke, ③ applicable controller, ④ cable length and ⑤ options.

Options

Name	Code	Page	Name	Code	Page
AQ seal	AQ	→P13	Master-axis designation	LM	→P14
Brake	B	→P13	Reverse homing specification	NM	→P14
Creep sensor	C	→P13	Slave-axis designation	S	→P14
Home limit switch	L	→P14	Optional cable exit direction	A1/A3	Refer to the figure below

* With the WXM type, the home limit switch (L) is a standard equipment.

Common Specifications

Positioning repeatability (Note 3)	± 0.02 mm [± 0.01 mm]
Drive system (Note 4)	Ball screw ø25 mm, rolled C10 [equivalent to C5]
Lost motion (Note 5)	0.05 mm or less [0.02 mm or less]
Allowable static moment	Refer to page 242
Allowable dynamic moment (Note 6)	Ma: 139.2 N · m Mb/Mc directions: 900 mm or less
Overhang load length	Ma direction: 900 mm or less, Mb/Mc directions: 900 mm or less
Base	Material: Aluminum with white alumite treatment
Applicable controller	T1: XSEL-J/K T2: XSEL-P/Q, SSEL, SCON
Cable length (Note 7)	N: No cable, S: 3 m, M: 5 m, X□□: Length specification
Ambient operating temperature · humidity	0 to 40°C, 85% RH or less (Non-condensing)

Dimensions

* Models with the brake have the same external dimensions but weigh 0.5 kg more.

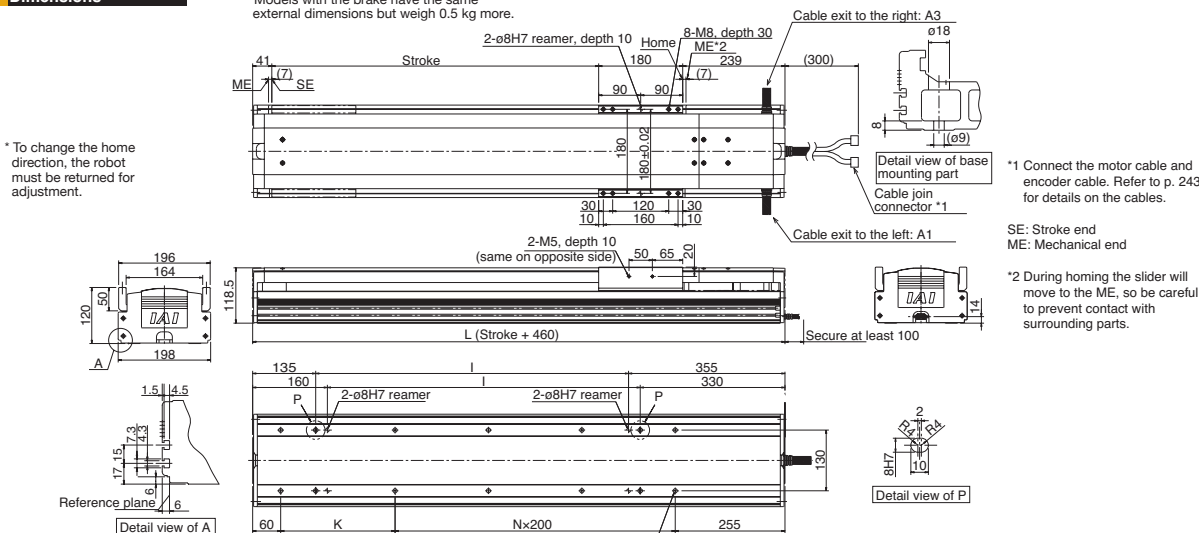

* To change the home direction, the robot must be returned for adjustment.

*1 Connect the motor cable and encoder cable. Refer to p. 243 for details on the cables.

SE: Stroke end
ME: Mechanical end

*2 During homing the slider will move to the ME, so be careful to prevent contact with surrounding parts.

Dimensions, Weight and Maximum Speed by Stroke

Stroke	100	200	300	400	500	600	700	800	900	1000	1100	1200	1300		
L	560	660	760	860	960	1060	1160	1260	1360	1460	1560	1660	1760		
I	70	170	270	370	470	570	670	770	870	970	1070	1170	1270		
K	245	145	245	145	245	145	245	145	245	145	245	145	245		
N	-	1	1	2	2	3	3	4	4	5	5	6	6		
m	4	6	6	8	8	10	10	12	12	14	14	16	16		
Weight (kg)	20.9	22.9	24.9	26.9	28.9	30.8	32.8	34.8	36.8	38.7	40.7	42.7	44.7		
Maximum speed (mm/s)	2000														
* Varies depending on the stroke.	Lead 50											1840	1570	1360	
	Lead 25											1090	920	785	680

Applicable Controller Specifications

Applicable controller	Maximum number of controlled axes	Compatible encoder type	Operating method	Supply voltage	Page
X-SEL-P/Q	6 axes	Absolute/Incremental	Program	Single phase/ Three-phase 200VAC	
X-SEL-K	4 axes			Single phase AC 100/200V	
X-SEL-J (Note 8)	4 axes			Single phase AC 200V	
SSEL	2 axes				
SCON	1 axis		Positioner pulse train control		

Caution

(Note 1) A longer stroke will result in a lower maximum speed to prevent the ball screw from reaching a dangerous speed. (Refer to the above table for the maximum speed at a given stroke.)

(Note 2) Refer to page 40 for the relationship of acceleration and payload. (Note 3,4,5) The figures in brackets apply to the ISPA Series. Other specification values apply to both the ISA and ISPA Series

(Note 6) Traveling life of 10,000 km is assumed.

(Note 7) The maximum cable length is 30 m. Specify the desired length in meters (e.g. X08 = 8 m)

(Note 8) If the WXM type is to be used vertically, use a controller other than the XSEL-J type.

* The WXM type comes with the home limit switch as a standard equipment, so use a controller of limit switch specification for this type.

ISA-WXMX-600

Single-Axis Robot: Super-Large X-Axis Mid-support Mechanism Type, Actuator Width 198mm, 600W. Straight Shape

ISPA-WXMX-600

Single-Axis Robot: Super-Large X-Axis Mid-support Mechanism Type, Actuator Width 198mm, 600W. Straight Shape High-Precision Specification

Model specification items	Series	Type	Encoder type	Motor Output	Lead	Stroke	Applicable controller	Cable length	Options
ISA: Standard Specification ISPA: High-Precision Specification	WXMX		A: Absolute I: Incremental	600:600W	40:40mm 20:20mm	900:900mm 2500:2500mm (every 100mm)	T1: XSEL-J/K T2: SCON SSEL XSEL-P/Q	N: None S: 3 m M: 5 m X: Length specification	Refer to the option list below.



* Refer to page 11 for the details of model specification items.

Models/Specifications

Model	Encoder type	Motor output (W)	Lead (mm)	Stroke (mm) In increments of 100mm	Speed (Note 1) (mm/s)	Acceleration (Note 2)		Load capacity (Note 2)		Rated thrust (N)
						Vertical (G)		Horizontal (G)		
						Rated	Maximum	Rated	Maximum	
ISA[ISPA]-WXMX-①-600-40-②-③-④-L-⑤	Absolute	600	40	900 ~ 2500	1 ~ 2400	0.3	Used only horizontally	60		255
ISA[ISPA]-WXMX-①-600-20-②-③-④-L-⑤	Incremental		20		1 ~ 1200	0.3		120		

* In the above model names, ① indicates the encoder type, ② stroke, ③ applicable controller, ④ cable length and ⑤ options.

Options

Name	Code	Page	Name	Code	Page
AQ seal	AQ	→P13	Master-axis designation	LM	→P14
Brake	B	→P13	Reverse homing specification	NM	→P14
Creep sensor	C	→P13	Slave-axis designation	S	→P14
Home limit switch	L	→P14	Optional cable exit direction	A1/A3	Refer to the figure below

* With the WXMX type, the home limit switch (L) is a standard equipment.

Common Specifications

Positioning repeatability (Note 3)	± 0.02 mm [± 0.01 mm]
Drive system (Note 4)	Ball screw ø20 mm, rolled C10 [equivalent to C5]
Lost motion (Note 5)	0.05 mm or less [0.02 mm or less]
Allowable static moment	Refer to page 242
Allowable dynamic moment (Note 6)	Ma: 139.2 N · m Mb: 199.9 N · m Mc: 391 N · m
Overhang load length	Ma direction: 900 mm or less, Mb/Mc directions: 900 mm or less
Base	Material: Aluminum with white alumite treatment
Applicable controller	T1: XSEL-J/K T2: XSEL-P/Q, SSEL, SCON
Cable length (Note 7)	N: No cable, S: 3 m, M: 5 m, X: Length specification
Ambient operating temperature · humidity	0 to 40°C, 85% RH or less (Non-condensing)

Dimensions

* Models with the brake have the same external dimensions but weigh 0.5 kg more.

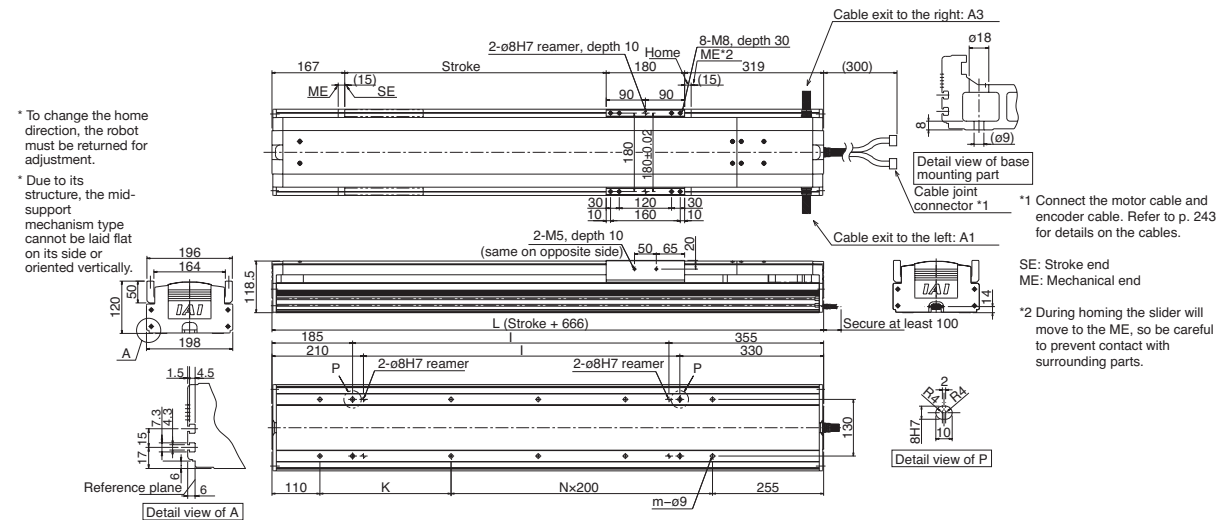

* To change the home direction, the robot must be returned for adjustment.

* Due to its structure, the mid-support mechanism type cannot be laid flat on its side or oriented vertically.

*1 Connect the motor cable and encoder cable. Refer to p. 243 for details on the cables.

SE: Stroke end
ME: Mechanical end

*2 During homing the slider will move to the ME, so be careful to prevent contact with surrounding parts.

Dimensions, Weight and Maximum Speed by Stroke

Stroke	900	1000	1100	1200	1300	1400	1500	1600	1700	1800	1900	2000	2100	2200	2300	2400	2500	
L	1566	1666	1766	1866	1966	2066	2166	2266	2366	2466	2566	2666	2766	2866	2966	3066	3166	
I	1026	1126	1226	1326	1426	1526	1626	1726	1826	1926	2026	2126	2226	2326	2426	2526	2626	
K	201	301	201	301	201	301	201	301	201	301	201	301	201	301	201	301	201	
N	5	5	6	6	7	7	8	8	9	9	10	10	11	11	12	12	13	
m	14	14	16	16	18	18	20	20	22	22	24	24	26	26	28	28	30	
Weight (kg)	38.6	40.6	42.6	44.6	46.6	48.5	50.5	52.5	54.5	56.5	58.4	60.4	62.4	64.4	66.3	68.3	70.3	
Maximum speed (mm/s)	2400		2200		1965		1725		1530		1365		1225		1110		1005	
* Varies depending on the stroke.	Lead 40		Lead 20		1200													

Applicable Controller Specifications

Applicable controller	Maximum number of controlled axes	Compatible encoder type	Operating method	Supply voltage	Page
X-SEL-P/Q	6 axes	Absolute/Incremental	Program	Single phase / Three-phase 200VAC	
X-SEL-K	4 axes			Single phase AC 100/200V	
X-SEL-J	4 axes			Single phase AC 200V	
SSEL	2 axes				
SCON	1 axis		Positioner pulse train control		



(Note 1) A longer stroke will result in a lower maximum speed to prevent the ball screw from reaching a dangerous speed. (Refer to the above table for the maximum speed at a given stroke.)
 (Note 2) The maximum acceleration is 0.3 G.
 (Note 3,4,5) The figures in brackets apply to the ISPA Series. Other specification values apply to both the ISA and ISPA Series.
 (Note 6) Traveling life of 10,000 km is assumed.
 (Note 7) The maximum cable length is 30 m. Specify the desired length in meters (e.g. X08 = 8 m)

* The WXMX type comes with the home limit switch as a standard equipment, so use a controller of limit switch specification for this type.

ISA-WXXM-750

Single-Axis Robot: Super-Large X-Axis Mid-support Mechanism Type, Actuator Width 198mm, 750W. Straight Shape

ISPA-WXXM-750

Single-Axis Robot: Super-Large X-Axis Mid-support Mechanism Type, Actuator Width 198mm, 750W. Straight Shape



Model specification items	Series	Type	Encoder type	Motor Output	Lead	Stroke	Applicable controller	Cable length	Options
ISA: Standard Specification ISPA: High-Precision Specification	WXXM		A: Absolute I: Incremental	750:750W	50:50mm 25:25mm	900:900mm i 2500:2500mm (every 100mm)	T1:XSEL-J/K T2:SCON SSEL XSEL-P/Q	N:None S:3 m M:5 m X□□: Length specification	Refer to the option list below.

* Refer to page 11 for the details of model specification items.

Models/Specifications

Model	Encoder type	Motor output (W)	Lead (mm)	Stroke(mm) In increments of 100mm	Speed (Note1) (mm/s)	Acceleration (Note 2)		Load capacity (Note 2)		Rated thrust (N)
						Horizontal (G)	Vertical (G)	Horizontal (G)	Vertical (G)	
						Rated	Maximum	Rated	Maximum	
ISA[ISPA]-WXXM-①-750-50-②-③-④-L-⑤	Absolute	750	50	900 ~ 2500	1 ~ 2000	0.3	Used only horizontally	60	Used only horizontally	255
ISA[ISPA]-WXXM-①-750-25-②-③-④-L-⑤	Incremental	750	25	900 ~ 2500	1 ~ 1250	0.3		120		510

* In the above model names, ① indicates the encoder type, ② stroke, ③ applicable controller, ④ cable length and ⑤ options.

Options

Name	Code	Page	Name	Code	Page
AQ seal	AQ	→P13	Master-axis designation	LM	→P14
Brake	B	→P13	Reverse homing specification	NM	→P14
Creep sensor	C	→P13	Slave-axis designation	S	→P14
Home limit switch	L	→P14	Optional cable exit direction	A1/A3	Refer to the figure below

* With the WXXM type, the home limit switch (L) is a standard equipment.

Common Specifications

Positioning repeatability (Note 3)	± 0.02 mm [± 0.01 mm]
Drive system (Note 4)	Ball screw ø25 mm, rolled C10 [equivalent to C5]
Lost motion (Note 5)	0.05 mm or less [0.02 mm or less]
Allowable static moment	Refer to page 242
Allowable dynamic moment (Note 6)	Ma: 139.2 N · m Mb: 199.9 N · m Mc: 391 N · m
Overhang load length	Ma direction: 900 mm or less, Mb/Mc directions: 900 mm or less
Base	Material: Aluminum with white alumite treatment
Applicable controller	T1: XSEL-J/K T2: XSEL-P/Q, SSEL, SCON
Cable length (Note 7)	N: No cable, S: 3 m, M: 5 m, X□□: Length specification
Ambient operating temperature · humidity	0 to 40°C, 85% RH or less (Non-condensing)

Dimensions

* Models with the brake have the same external dimensions but weigh 0.5 kg more.

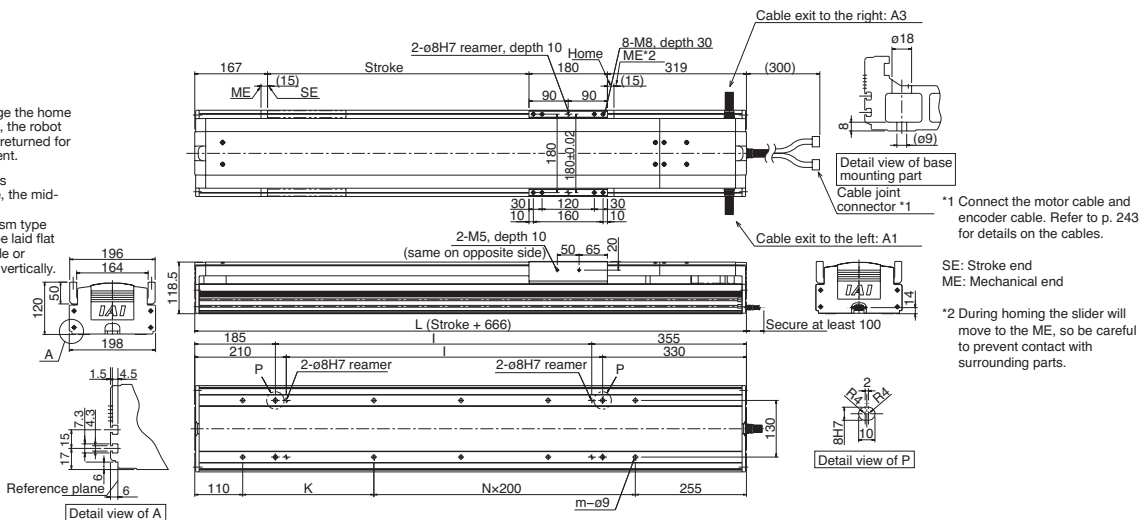

* To change the home direction, the robot must be returned for adjustment.

* Due to its structure, the mid-support mechanism type cannot be laid flat on its side or oriented vertically.

*1 Connect the motor cable and encoder cable. Refer to p. 243 for details on the cables.

SE: Stroke end
ME: Mechanical end
*2 During homing the slider will move to the ME, so be careful to prevent contact with surrounding parts.

Dimensions, Weight and Maximum Speed by Stroke

Stroke	900	1000	1100	1200	1300	1400	1500	1600	1700	1800	1900	2000	2100	2200	2300	2400	2500	
L	1566	1666	1766	1866	1966	2066	2166	2266	2366	2466	2566	2666	2766	2866	2966	3066	3166	
I	1026	1126	1226	1326	1426	1526	1626	1726	1826	1926	2026	2126	2226	2326	2426	2526	2626	
K	201	301	201	301	201	301	201	301	201	301	201	301	201	301	201	301	201	
N	5	5	6	6	7	7	8	8	9	9	10	10	11	11	12	12	13	
m	14	14	16	16	18	18	20	20	22	22	24	24	26	26	28	28	30	
Weight (kg)	41.4	43.4	45.4	47.4	49.4	51.3	53.3	55.3	57.3	59.3	61.2	63.2	65.2	67.2	69.1	71.1	73.1	
Maximum speed (mm/s)	2000																	
	Lead 50	1250																
* Varies depending on the stroke.	Lead 25	1200																
	Lead 25	1075																
	1930																	
	1740																	
	1580																	
	1440																	
	1320																	
	1210																	
	1115																	
	1035																	

Applicable Controller Specifications

Applicable controller	Maximum number of controlled axes	Compatible encoder type	Operating method	Supply voltage	Page
X-SEL-P/Q	6 axes	Absolute/Incremental	Program	Single phase/ Three-phase 200VAC	
X-SEL-K	4 axes			Single phase AC 100/200V	
X-SEL-J	4 axes			Single phase AC 200V	
SSEL	2 axes				
SCON	1 axis		Positioner pulse train control		

Caution

(Note 1) A longer stroke will result in a lower maximum speed to prevent the ball screw from reaching a dangerous speed. (Refer to the above table for the maximum speed at a given stroke.)
 (Note 2) The maximum acceleration is 0.3 G.
 (Note 3,4,5) The figures in brackets apply to both the ISA and ISPA Series. Other specification values apply to both the ISA and ISPA Series.
 (Note 6) Traveling life of 10,000 km is assumed.
 (Note 7) The maximum cable length is 30 m. Specify the desired length in meters (e.g. X08 = 8 m)

* The WXXM type comes with the home limit switch as a standard equipment, so use a controller of limit switch specification for this type.

Technical Information

How to Calculate Positioning Time

Positioning time of the actuator can be calculated.

The following two operation patterns are applicable depending on the travel distance and acceleration/deceleration condition.

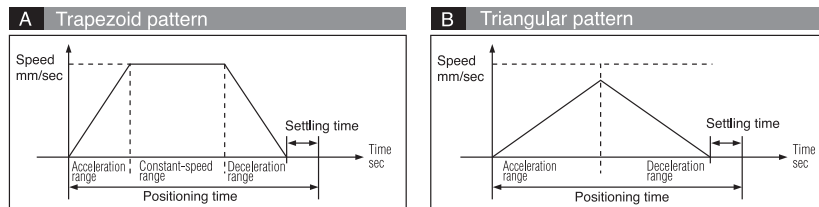

First, check whether the operation in question conforms to the trapezoid pattern or triangular pattern and then calculate positioning time using the applicable equation.

How to Determine Operation Pattern

Whether an operation conforms to the trapezoid pattern or triangular pattern can be determined by identifying if the attained speed is higher or lower than the specified speed when the actuator is operated over the target travel distance at the specified acceleration.

$$\begin{aligned} \text{Attained speed (Vmax)} &= \sqrt{\text{Travel distance (Smm)} \times \text{Specified acceleration}} \\ &= \sqrt{\text{Smm} \times 9,800\text{mm/sec}^2 \times \text{Acceleration setting (G)}} \end{aligned}$$

One of the following two results will be obtained:

- Specified speed (V) < Attained speed (Vmax) ----- Trapezoid pattern
- Specified speed (V) > Attained speed (Vmax) ----- Triangular pattern

How to Calculate Positioning Time

A Trapezoid pattern

$$\text{Positioning time (T)} = \frac{\text{Distance (mm)}}{\text{Speed (mm/sec)}} + \frac{\text{Speed (mm/sec)}}{\text{Acceleration (mm/sec}^2)} + \text{Settling time}$$

B Triangular pattern

$$\text{Positioning time} = 2 \sqrt{\frac{\text{Distance (mm)}}{\text{Acceleration (mm/sec}^2)}} + \text{Settling time}$$

$$\begin{aligned} \text{Acceleration time} &= \frac{\text{Speed* (mm/sec)}}{\text{Acceleration (mm/sec}^2)} \\ \text{Travel time during acceleration} &= \frac{\text{Acceleration (mm/sec}^2) \times (\text{Acceleration time (sec)})^2}{2} \end{aligned}$$

* Use the specified speed for the trapezoid pattern and attained speed for the triangular pattern.

Note
 • Obtain acceleration by multiplying the controller's acceleration/deceleration setting (G) by 9800 mm/sec². If the controller's acceleration/deceleration setting is 0.3 G, acceleration is calculated as 0.3 x 9800 mm/sec² = 2940 mm/sec².
 • Settling time is a period used for determining if the operation to the target position has completed. Normally a settling time of approx. 0.15 sec should be considered for a ball-screw type and 0.2 sec, for a belt type.

Positioning Time

Specified acceleration	Specified speed	Travel distance (mm)																		
		10	20	30	40	50	100	150	200	250	300	350	400	450	500	600	1000	1100	1300	1400
0.3G	100	0.13	0.23	0.33	0.43	0.53	1.03	1.53	2.03	2.53	3.03	3.53	4.03	4.53	5.03	6.03	10.03	11.03	13.03	14.03
	200	0.12	0.17	0.22	0.27	0.32	0.57	0.82	1.07	1.32	1.57	1.82	2.07	2.32	2.57	3.07	5.07	5.57	6.57	7.07
	300	0.12	0.16	0.2	0.24	0.27	0.44	0.6	0.77	0.94	1.1	1.27	1.44	1.6	1.77	2.1	3.44	3.77	4.44	4.77
	400	0.12	0.16	0.2	0.23	0.26	0.39	0.51	0.64	0.76	0.89	1.01	1.14	1.26	1.39	1.64	2.64	2.89	3.39	3.64
	500	0.12	0.16	0.2	0.23	0.26	0.37	0.47	0.57	0.67	0.77	0.87	0.97	1.07	1.17	1.37	2.17	2.37	2.77	2.97
	600	0.12	0.16	0.2	0.23	0.26	0.37	0.45	0.54	0.62	0.7	0.79	0.87	0.95	1.04	1.2	1.87	2.04	2.37	2.54
	700	0.12	0.16	0.2	0.23	0.26	0.37	0.45	0.52	0.6	0.67	0.74	0.81	0.88	0.95	1.1	1.67	1.81	2.1	2.24
	800	0.12	0.16	0.2	0.23	0.26	0.37	0.45	0.52	0.58	0.65	0.71	0.77	0.83	0.9	1.02	1.52	1.65	1.9	2.02
	900	0.12	0.16	0.2	0.23	0.26	0.37	0.45	0.52	0.58	0.64	0.7	0.75	0.81	0.86	0.97	1.42	1.53	1.75	1.86
	1000	0.12	0.16	0.2	0.23	0.26	0.37	0.45	0.52	0.58	0.64	0.69	0.74	0.79	0.84	0.94	1.34	1.44	1.64	1.74
1750	0.12	0.16	0.2	0.23	0.26	0.37	0.45	0.52	0.58	0.64	0.69	0.74	0.78	0.82	0.9	1.17	1.37	1.56	1.65	
2000	0.12	0.16	0.2	0.23	0.26	0.37	0.45	0.52	0.58	0.64	0.69	0.74	0.78	0.82	0.9	1.17	1.22	1.33	1.48	

(Note) The above figures do not include settling time (0.15 sec for ball screw, 0.2 sec for belt). Triangular pattern

Acceleration Time

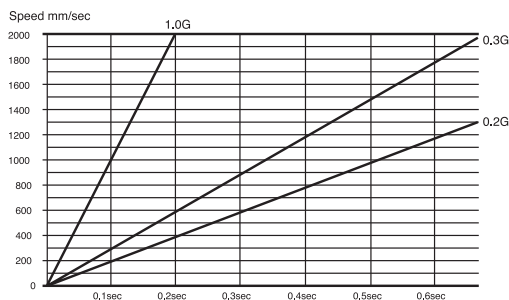

ISA/ISPA Series Table of Load Capacity by Acceleration Condition

- Caution
1. The load capacity values shown below are provided for reference purposes only. They are not guaranteed and must therefore be used only as guidelines.
 2. Even when the acceleration is below the rated acceleration, the load capacity will not increase beyond the load capacity at the rated acceleration.
 3. Use models other than those in the ISA/ISPA Series at accelerations below their rated acceleration

ISA / ISPA

Type	Motor output (W)	Lead (mm)	Maximum speed (mm/sec)	Rated acceleration (G)	Load capacity at rated acceleration (kg)		Maximum acceleration (G)	Load capacity at each acceleration (kg)							
								0.3G	0.4G	0.5G	0.6G	0.7G	0.8G	0.9G	1.0G
SXM	60	16	800	0.3	Horizontal	12	1.0	12	9	7	6	5	4.5	4	3.5
					Vertical	3	0.7	3	2.5	2.3	2.1	2	-	-	-
SYM	60	8	400	0.3	Horizontal	25	0.6	25	18.5	15	12	-	-	-	-
					Vertical	6	0.5	6	5.5	5	-	-	-	-	-
SZM	60	4	200	0.15	Horizontal	50	0.5	50	37.5	30	-	-	-	-	-
					Vertical	14	0.3	12	-	-	-	-	-	-	-
SZM	60	8	400	0.3	Vertical	6	0.3	6	5.5	5	-	-	-	-	-
					4	200	0.15	Vertical	14	0.3	12	-	-	-	-
MXM	100	20	1000	0.3	Horizontal	20	1.0	20	15	12	10	8.5	7.5	6.5	6
					Vertical	3.5	0.8	3.5	3.2	2.9	2.7	2.4	2	-	-
MYM	100	10	500	0.3	Horizontal	40	0.6	40	30	24	20	-	-	-	-
					Vertical	9	0.5	9	7.6	7	-	-	-	-	-
MZM	100	5	250	0.15	Horizontal	80	0.5	80	60	45	-	-	-	-	-
					Vertical	19	0.3	15	-	-	-	-	-	-	-
MZM	100	10	500	0.3	Vertical	9	0.5	9	7.6	7	-	-	-	-	-
					5	250	0.15	Vertical	19	0.3	15	-	-	-	-
MXM	200	30	1500	0.3	Horizontal	25	1.0	25	20	17	15	13.5	12	11	10
					Vertical	6	1.0	6	4.7	4.3	3.9	3.6	3.4	3.1	2
MYM	200	20	1000	0.3	Horizontal	40	1.0	40	30	24	20	17	15	13.5	12
					Vertical	9	0.8	9	7.6	7	6.5	6	5	-	-
MZM	200	10	500	0.3	Horizontal	80	0.6	80	60	48.5	40	-	-	-	-
					Vertical	19	0.5	19	16.3	15	-	-	-	-	-
MXMX	200	30	1500	0.3	Horizontal	25	0.3	25	-	-	-	-	-	-	-
					20	1000	0.3	Horizontal	40	0.3	40	-	-	-	-
LXM	200	20	1000	0.3	Horizontal	40	1.0	40	30	24	20	17	15	13.5	12
					Vertical	9	0.8	9	6.6	6	5.5	5	4	-	-
LYM	200	10	500	0.3	Horizontal	80	0.6	80	60	48.5	40	-	-	-	-
					Vertical	19	0.5	19	15.3	14	-	-	-	-	-
LZM	200	10	500	0.3	Vertical	19	0.5	19	15.3	14	-	-	-	-	-
					LXM	400	40	2000	0.3	Horizontal	40	1.0	40	30	25
Vertical	9	1.0	9	6.6						6	5.5	5	4.6	4.3	4
LYM	400	20	1000	0.3	Horizontal	80	1.0	80	60.5	48.5	40.5	34.5	30	27	24
					Vertical	19	0.8	19	15.3	14.1	13.1	12.2	10	-	-
LZM	400	10	500	0.3	Vertical	39	0.5	39	32.6	28	-	-	-	-	-
					LXMX	200	20	1000	0.3	Horizontal	40	0.3	40	-	-
LXMX	400	40	2000	0.3						Horizontal	40	0.3	40	-	-
					LXMX	400	20	1000	0.3	Horizontal	80	0.3	80	-	-
LXUWX	200	20	1000	0.3						Horizontal	40	0.3	40	-	-
					LXUWX	400	40	2000	0.3	Horizontal	40	0.3	40	-	-
LXUWX	400	20	1000	0.3						Horizontal	80	0.3	80	-	-
					WXM	600	40	2000	0.3	Horizontal	60	1.0	60	45	36
Vertical	14	1.0	14	9						8.1	7.4	6.7	6.1	5.6	5
WXM	600	20	1000	0.3	Horizontal	120	1.0	120	91	72	60	52	45	40	36
					Vertical	29	0.8	29	22	20.3	18.8	17.4	15	-	-
WXM	600	10	500	0.3	Horizontal	150	0.6	150	112	90	75	-	-	-	-
					Vertical	60	0.5	60	48	40	-	-	-	-	-
WXM	750	40	2000	0.3	Horizontal	75	1.0	75	56	45	37	32	28	25	22
					Vertical	18	1.0	18	12.3	11.2	10.2	9.4	8.6	8	7
WXM	750	20	1000	0.3	Horizontal	150	1.0	150	113	91	75	65	56	50	45
					Vertical	37	0.8	37	28.5	26.3	24.4	22.8	20	-	-
WXM	600	40	2000	0.3	Horizontal	60	0.3	60	-	-	-	-	-	-	-
					20	1000	0.3	Horizontal	120	0.3	120	-	-	-	-
WXM	750	40	2000	0.3	Horizontal	75	0.3	75	-	-	-	-	-	-	-
					20	1000	0.3	Horizontal	150	0.3	150	-	-	-	-