

HarmonicDrive® CSF-GH Standard Series

Size

14, 20, 32, 45, 65

5
Sizes

Peak torque

18Nm to 2630Nm

Reduction ratio

50:1 to 160:1

Zero backlash

High Accuracy

Repeatability ± 4 to ± 10 arc-sec

High Load Capacity Output Bearing

A Cross Roller bearing is integrated with the output flange to provide high moment stiffness, high load capacity and precise positioning accuracy.

Easy mounting to a wide variety of servomotors

Quick Connect® motor adaptation system includes a clamshell style servo coupling and piloted adapter flange.



CONTENTS

Rating Table, Ratcheting Torque, Buckling Torque.....	89
Performance Table.....	90
Torsional Stiffness	91
Outline Dimensions.....	92-96
Rating Table Definitions, Life, Torque Limits.....	98-99
Torsional Stiffness, Vibration, Efficiency.....	100-101
Product Sizing & Selection.....	102-103

CSF - 20 - 100 - GH - F0 - Motor Code

Model Name	Size	Reduction Ratio	Model	Output Configuration	Input Configuration
HarmonicDrive® CSF Standard	14	50, 80, 100	GH: Gearhead	F0: Flange output J2: Shaft output without key J6: Shaft output with key and center tapped hole	This code represents the motor mounting configuration. Please contact us for a unique part number based on the motor you are using.
	20	50, 80, 100, 120, 160			
	32				
	45				
	65				

Gearhead Construction

Figure 088-1

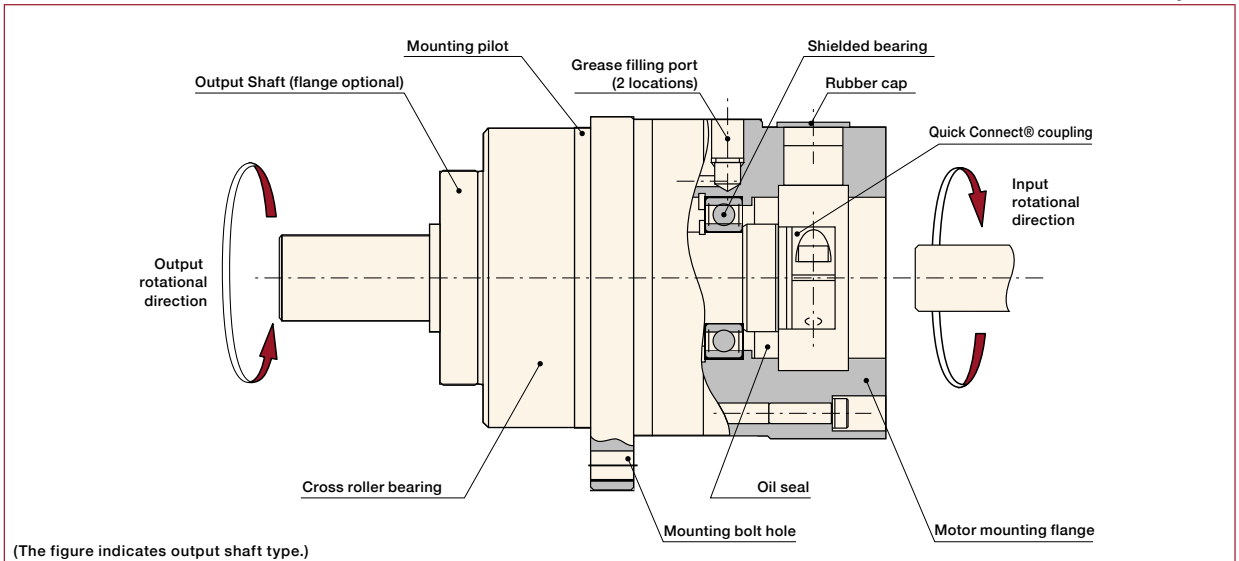

Rating Table CSF-GH

Table 089-1

Size	Ratio	Rated Torque at 2000 rpm *1	Rated Torque at 3000 rpm *2	Limit for Average Torque *3	Limit for Repeated Peak Torque *4	Limit for Momentary Torque *5	Max. Average Input Speed *6	Max. Input Speed *7	Mass *8	
		Nm	Nm	Nm	Nm	Nm	rpm	rpm	Shaft	Flange
									kg	kg
14	50	5.4	4.7	6.9	18	35	3500	8500	0.62	0.50
	80	7.8	6.8	11	23	47				
	100	7.8	6.8	11	28	54				
20	50	25	22	34	56	98	3500	6500	1.8	1.4
	80	34	30	47	74	127				
	100	40	35	49	82	147				
	120	40	35	49	87	147				
	160	40	35	49	92	147				
32	50	76	66	108	216	382	3500	4800	4.6	3.2
	80	118	103	167	304	568				
	100	137	120	216	333	647				
	120	137	120	216	353	686				
	160	137	120	216	372	686				
45	50	176	154	265	500	950	3000	3800	13	10
	80	313	273	390	706	1270				
	100	353	308	500	755	1570				
	120	402	351	620	823	1760				
	160	402	351	630	882	1910				
65	80	745	651	1040	2110	3720	1900	2800	32	24
	100	951	831	1520	2300	4750				
	120	951	831	1570	2510	4750				
	160	951	831	1570	2630	4750				

*1: Rated torque is based on L10 life of 7,000 hours when input speed is 2000 rpm.

*2: Rated torque is based on L10 life of 7,000 hours when input speed is 3000 rpm, input speed for size 65 is 2800 rpm.

*3: Average load torque calculated based on the application motion profile must not exceed values shown in the table. See p. 102.

*4: The limit for torque during start and stop cycles.

*5: The limit for torque during emergency stops or from external shock loads. Always operate below this value.

*6: Max value of average input rotational speed during operation.

*7: Maximum instantaneous input speed.

*8: The mass is for the gearhead only (without input shaft coupling & motor flange). Please contact us for the mass of your specific configuration.

Ratcheting Torque CSF-GH

(Unit: Nm) Table 089-2

Ratio \ Size	14	20	32	45	65
50	88	220	980	2700	—
80	110	350	1400	3900	11000
100	84	260	1000	3100	9400
120	—	240	980	2800	8300
160	—	220	980	2600	8000

Buckling Torque CSF-GH

(Unit: Nm) Table 089-3

Size	14	20	32	45	65
All Ratios	190	560	2200	5800	17000

Performance Table CSF-GH

Table 090-1

Size	Flange Type	Ratio	Accuracy*1	Repeatability*2	Starting torque*3	Backdriving torque*4	No-load running torque*5
			arc min	arc sec	Ncm	Nm	Ncm
14	All	50	1.5	±10	8.2	2.9	5.6
		80			6.9	3.9	5.1
		100			6.6	4.7	4.6
20	Type I	50	1.0	±8	13	7.8	11
		80			10	9.6	10
		100			9.6	12	10
		120			9.1	13	9.8
		160			8.6	17	9.6
	Type II & III	50	1.0	±8	20	12	11
		80			17	16	10
		100			16	19	10
		120			16	23	9.8
		160			15	29	9.6
32	Type II	50	1.0	±6	58	35	47
		80			46	44	42
		100			45	54	41
		120			42	61	40
		160			41	79	40
	Type I & III	50	1.0	±6	50	30	47
		80			38	37	42
		100			37	45	41
		120			34	49	40
		160			33	64	40
45	All	50	1.0	±5	123	74	120
		80			95	92	109
		100			89	107	107
		120			85	123	105
		160			79	152	103
65	All	80	1.0	±4	186	179	297
		100			166	200	289
		120			156	226	285
		160			139	268	278

*1: Accuracy values represent the difference between the theoretical angle and the actual angle of output for any given input. The values shown in the table are maximum values.

Figure 090-1

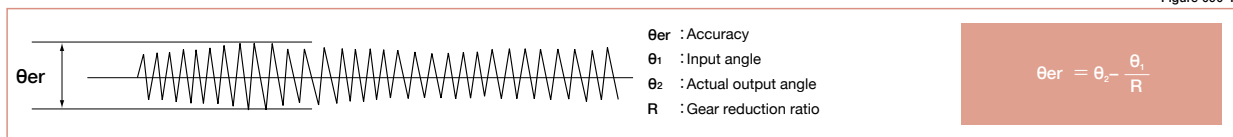

*2: The repeatability is measured by moving to a given theoretical position seven times, each time approaching from the same direction. The actual position of the output shaft is measured each time and repeatability is calculated as the 1/2 of the maximum difference of the seven data points. Measured values are indicated in angles (arc-sec) prefixed with "±". The values in the table are maximum values.

Figure 090-2

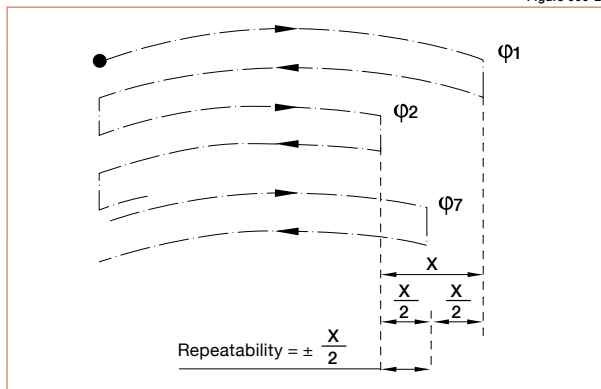

*3: Starting torque is the torque value applied to the input side at which the output first starts to rotate. The values in the table are maximum values.

Table 090-2

Load	No load
Speed reducer surface temperature	25°C

*4: Backdriving torque is the torque value applied to the output side at which the input first starts to rotate. The values in the table are maximum values.

Note: Never rely on these values as a margin in a system that must hold an external load. A brake must be used where back driving is not permissible.

Table 090-3

Load	No load
Speed reducer surface temperature	25°C

*5: No-load running torque is the torque required at the input to operate the gearhead at a given speed under a no-load condition. The values in the table are average values.

Table 090-4

Input speed	2000 rpm
Load	No load
Speed reducer surface temperature	25°C

Torsional Stiffness CSF-GH

Table 091-1

Symbol		Size	14	20	32	45	65	
T ₁		Nm	2.0	7.0	29	76	235	
		kgfm	0.2	0.7	3.0	7.8	24	
T ₂		Nm	6.9	25	108	275	843	
		kgfm	0.7	2.5	11	28	86	
Reduction ratio 50	K ₁	x10 ⁴ Nm/rad	0.34	1.3	5.4	15	—	
		kgfm/arc min	0.1	0.38	1.6	4.3	—	
	K ₂	x10 ⁴ Nm/rad	0.47	1.8	7.8	20	—	
		kgfm/arc min	0.14	0.52	2.3	6.0	—	
	K ₃	x10 ⁴ Nm/rad	0.57	2.3	9.8	26	—	
		kgfm/arc min	0.17	0.67	2.9	7.6	—	
	θ ₁	x10 ⁻⁴ rad	5.8	5.2	5.5	5.2	—	
		arc min	2.0	1.8	1.9	1.8	—	
	θ ₂	x10 ⁻⁴ rad	16	15.4	15.7	15.1	—	
		arc min	5.6	5.3	5.4	5.2	—	
	Reduction ratio 80 or more	K ₁	x10 ⁴ Nm/rad	0.47	1.6	6.7	18	54
			kgfm/arc min	0.14	0.47	2.0	5.4	16
K ₂		x10 ⁴ Nm/rad	0.61	2.5	11	29	88	
		kgfm/arc min	0.18	0.75	3.2	8.5	26	
K ₃		x10 ⁴ Nm/rad	0.71	2.9	12	33	98	
		kgfm/arc min	0.21	0.85	3.7	9.7	29	
θ ₁		x10 ⁻⁴ rad	4.1	4.4	4.4	4.1	4.4	
		arc min	1.4	1.5	1.5	1.4	1.5	
θ ₂		x10 ⁻⁴ rad	12	11.3	11.6	11.1	11.3	
		arc min	4.2	3.9	4.0	3.8	3.9	

* The values in this table are average values. See page 100 for more information about torsional stiffness.

Hysteresis Loss CSF-GH

Reduction ratio 50: Approx. 5.8X10⁻⁴ rad (2arc min)
 Reduction ratio 80 or more: Approx. 2.9X10⁻⁴ rad (1arc min)

CSF-GH-14 Outline Dimensions

Only primary dimensions are shown in the drawings below. Refer to the confirmation drawing for detailed dimensions.

Figure 092-1

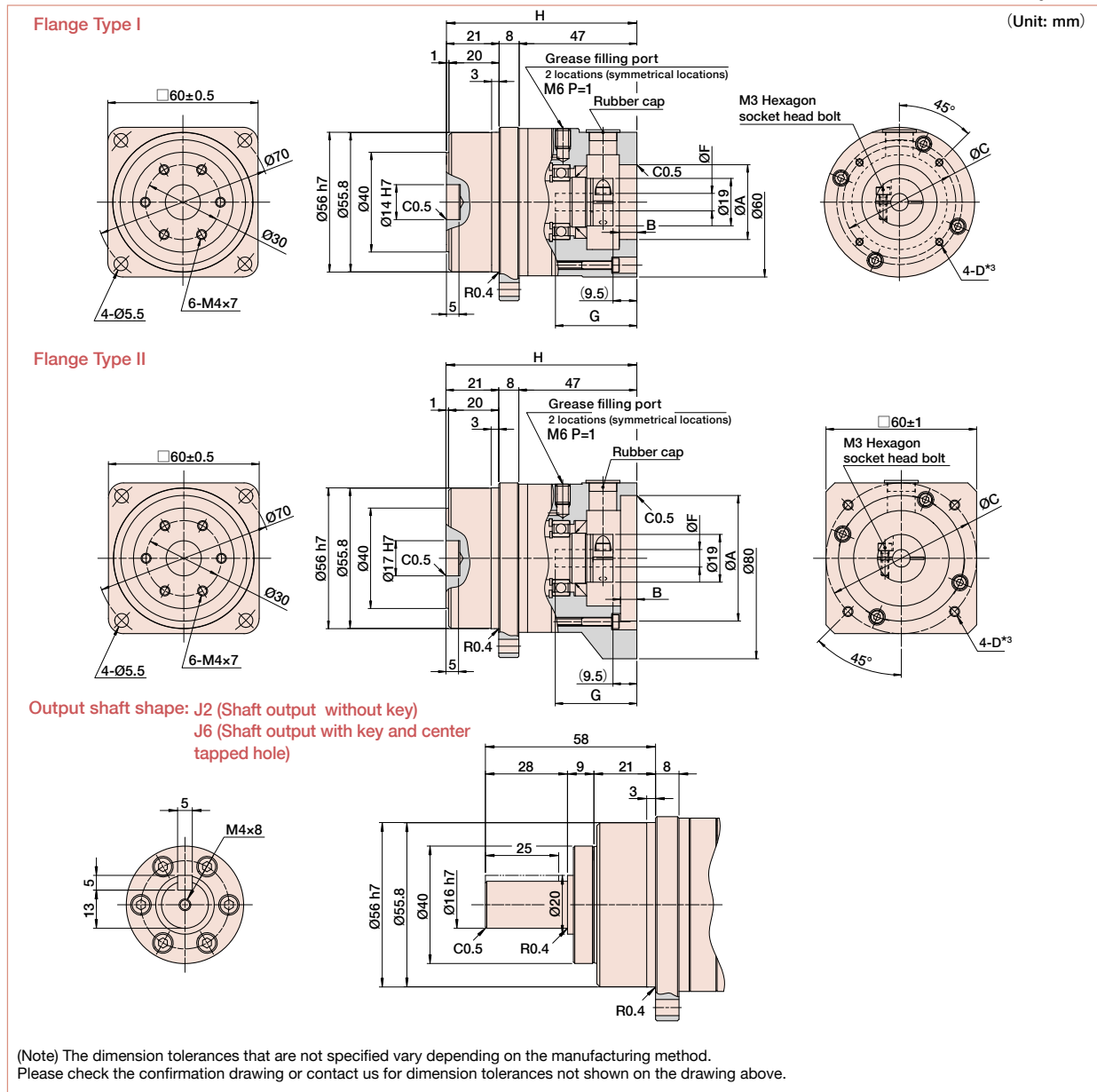

Dimension Table

(Unit: mm) Table 092-1

Flange	Coupling	A (H7) ^{*1}		B ^{*1}	C ^{*1}		F (H7) ^{*1}		G ^{*1}		H ^{*1}	Moment of Inertia (10 ⁻⁴ kgm ²)	Mass (kg) ^{*2}	
		Min.	Max.	Max.	Min.	Max.	Min.	Max.	Min.	Max.			Typical	Shaft
Type I	1	30	50	6.5	35	55	6.0	8	20.5	32.5	76	0.07	0.88	0.76
Type II	1	30	55	7	55	75	6.0	8	20.5	32.5	76	0.07	0.90	0.78

Refer to the confirmation drawing for detailed dimensions.

Dimensions of typical products are shown. Please contact us for other mounting options if the configurations shown above are not suitable for your particular motor.

*1 May vary depending on motor interface dimensions.

*2 The mass will vary slightly depending on the ratio and on the inside diameter of the input shaft coupling.

*3 Tapped hole for mounting screw.

CSF-GH-20 Outline Dimensions

Only primary dimensions are shown in the drawings below. Refer to the confirmation drawing for detailed dimensions.

Figure 093-1

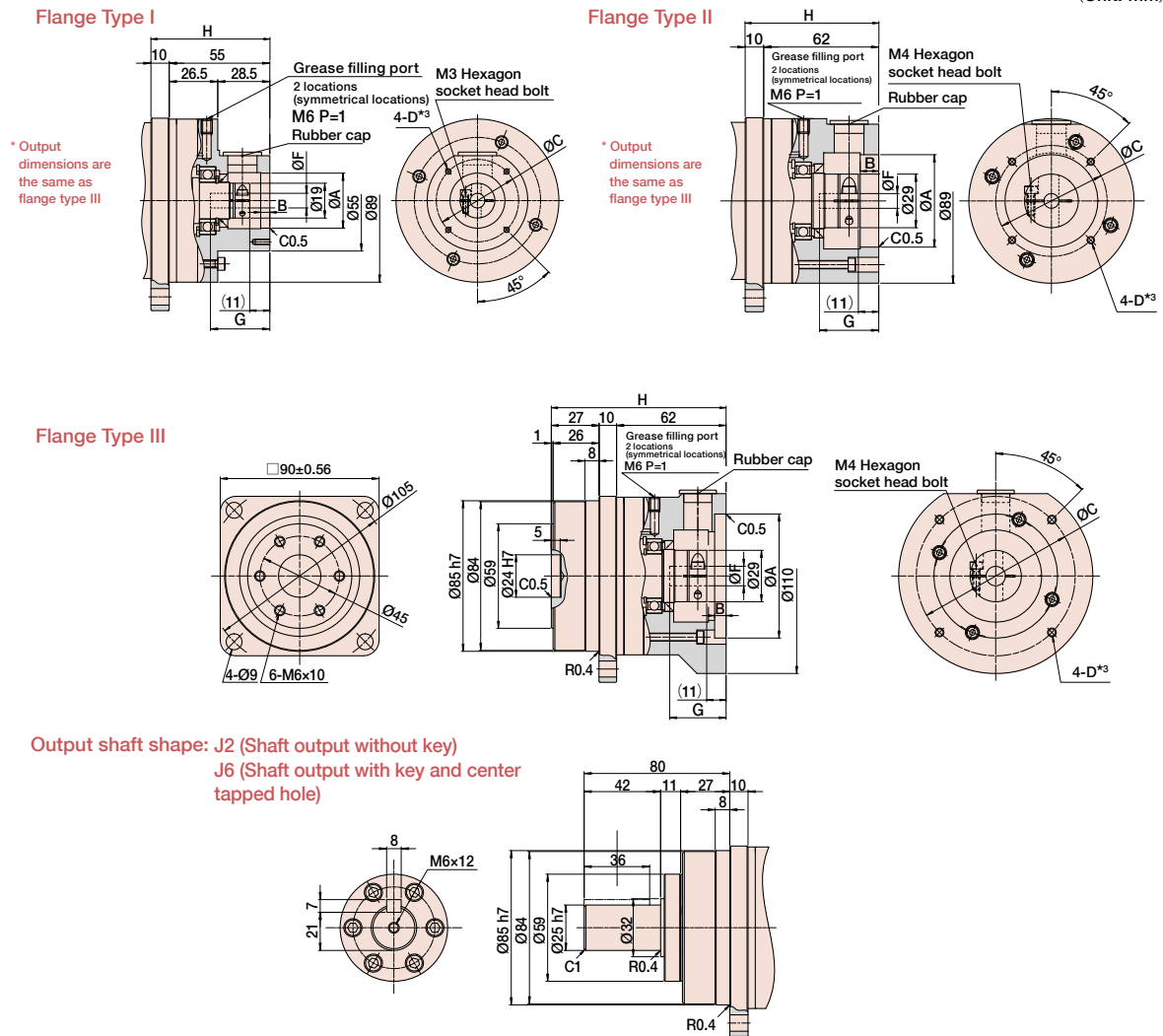

Output shaft shape: J2 (Shaft output without key)
 J6 (Shaft output with key and center tapped hole)

(Note) The dimension tolerances that are not specified vary depending on the manufacturing method. Please check the confirmation drawing or contact us for dimension tolerances not shown on the drawing above.

Dimension Table

(Unit: mm) Table 093-1

Flange	Coupling	A (H7) ¹		B ¹	C ¹		F (H7) ¹		G ¹		H ¹	Moment of Inertia	Mass (kg) ²	
		Min.	Max.	Max.	Min.	Max.	Min.	Max.	Min.	Max.	Typical	(10 ⁻⁴ kgm ²)	Shaft	Flange
Type I	1	30	45	5	35	50	7.0	7.8	22	33	92	0.28	2.3	1.9
Type II	2	50	79	10	55	84	8.0	14.6	24	32	99	0.42	2.6	2.2
Type III	2	50	100	10	55	105	8.0	14.6	24	32	99	0.42	2.8	2.4

Refer to the confirmation drawing for detailed dimensions. Dimensions of typical products are shown. Please contact us for other mounting options if the configurations shown above are not suitable for your particular motor.
 *1 May vary depending on motor interface dimensions.
 *2 The mass will vary slightly depending on the ratio and on the inside diameter of the input shaft coupling.
 *3 Tapped hole for motor mounting screw.

CSF-GH Series Harmonic Drive High-Performance Gearhead for Servomotors

CSF-GH-32 Outline Dimensions

Only primary dimensions are shown in the drawings below. Refer to the confirmation drawing for detailed dimensions.

Figure 094-1

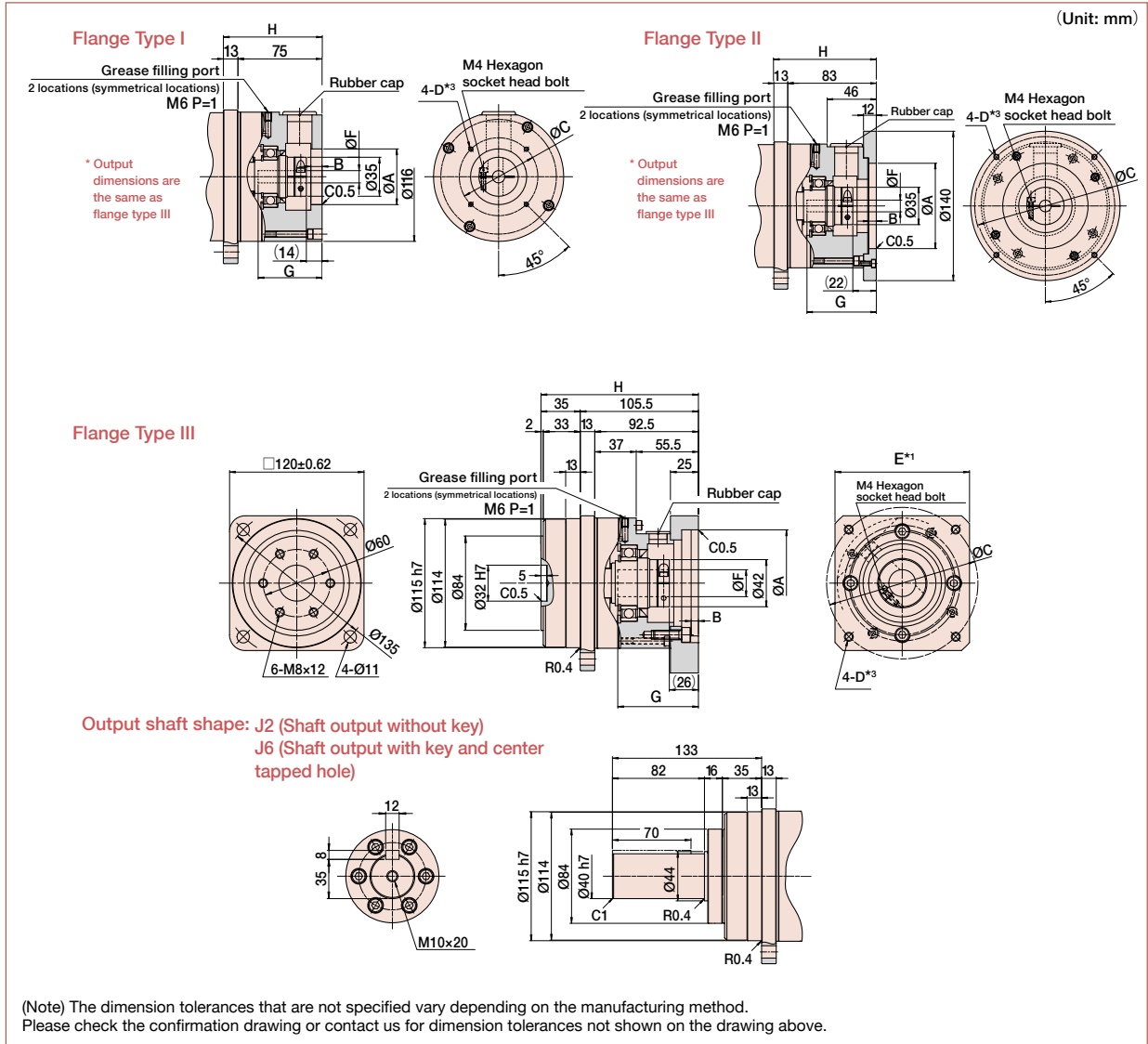

Dimension Table

(Unit: mm) Table 094-1

Flange	Coupling	A (H7) *1		B *1	C *1		F (H7) *1		G *1		H *1	Moment of Inertia (10 ⁻⁴ kgm ²)	Mass (kg) *2	
		Min.	Max.	Max.	Min.	Max.	Min.	Max.	Min.	Max.	Max.		Shaft	Flange
Type I	1	50	105	10	55	100	10.8	19.6	27	57	123	2.7	6.4	5.0
	3						8.8	19.6	27	46			6.4	5.0
Type II	2	60	175	5	70	225	16	25.8	39	72	140.5	2.7	7.9	6.5
Type III	1	35	130	7	40	135	10.8	19.6	35	65	131	2.0	6.6	5.2
	3						8.8	19.6	35	54			6.6	5.2

Refer to the confirmation drawing for detailed dimensions.

Dimensions of typical products are shown. Please contact us for other mounting options if the configurations shown above are not suitable for your particular motor.

*1 May vary depending on motor interface dimensions.

*2 The mass will vary slightly depending on the ratio and on the inside diameter of the input shaft coupling.

*3 Tapped hole for motor mounting screw.

CSF-GH-45 Outline Dimensions

Only primary dimensions are shown in the drawings below. Refer to the confirmation drawing for detailed dimensions.

Figure 095-1

(Unit: mm)

Flange Type I

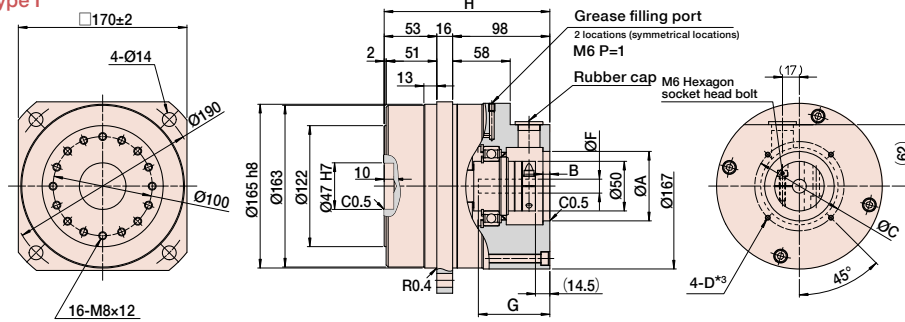

Flange Type II

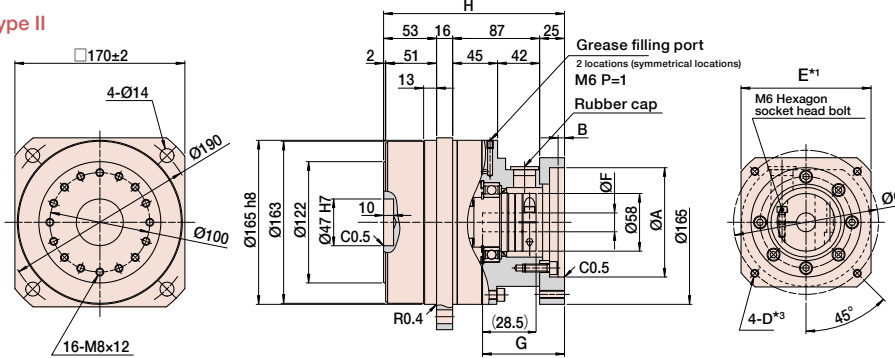

Output shaft shape: J2 (Shaft output without key)
J6 (Shaft output with key and center tapped hole)

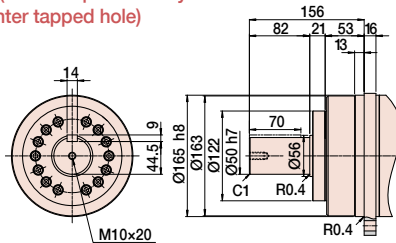

(Note) The dimension tolerances that are not specified vary depending on the manufacturing method. Please check the confirmation drawing or contact us for dimension tolerances not shown on the drawing above.

Dimension Table

(Unit: mm) Table 095-1

Flange	Coupling	A (H7) ^{*1}		B ^{*1}	C ^{*1}		F (H7) ^{*1}		G ^{*1}		H ^{*1}	Moment of Inertia (10 ⁻⁴ kgm ²)	Mass (kg) ^{*2}	
		Min.	Max.	Max.	Min.	Max.	Min.	Max.	Min.	Max.	Typical		Shaft	Flange
Type I	1	70	119	7	80	157	14.0	29.4	30.5	72	167	11	17.3	14.3
Type I	2	70	119	7	80	157	19.0	41	30.5	68	167	11	17.3	14.3
Type II	1	70	175	6.5	80	225	14.0	29.4	44.5	86	181	11	17.7	14.7
Type II	2	70	175	6.5	80	225	19.0	41	44.5	82	181	11	17.7	14.7

Refer to the confirmation drawing for detailed dimensions.

Dimensions of typical products are shown. Please contact us for other mounting options if the configurations shown above are not suitable for your particular motor.

*1 May vary depending on motor interface dimensions.

*2 The mass will vary slightly depending on the ratio and on the inside diameter of the input shaft coupling.

*3 Tapped hole for motor mounting screw.

CSF-GH-65 Outline Dimensions

Only primary dimensions are shown in the drawings below. Refer to the confirmation drawing for detailed dimensions.

Figure 096-1

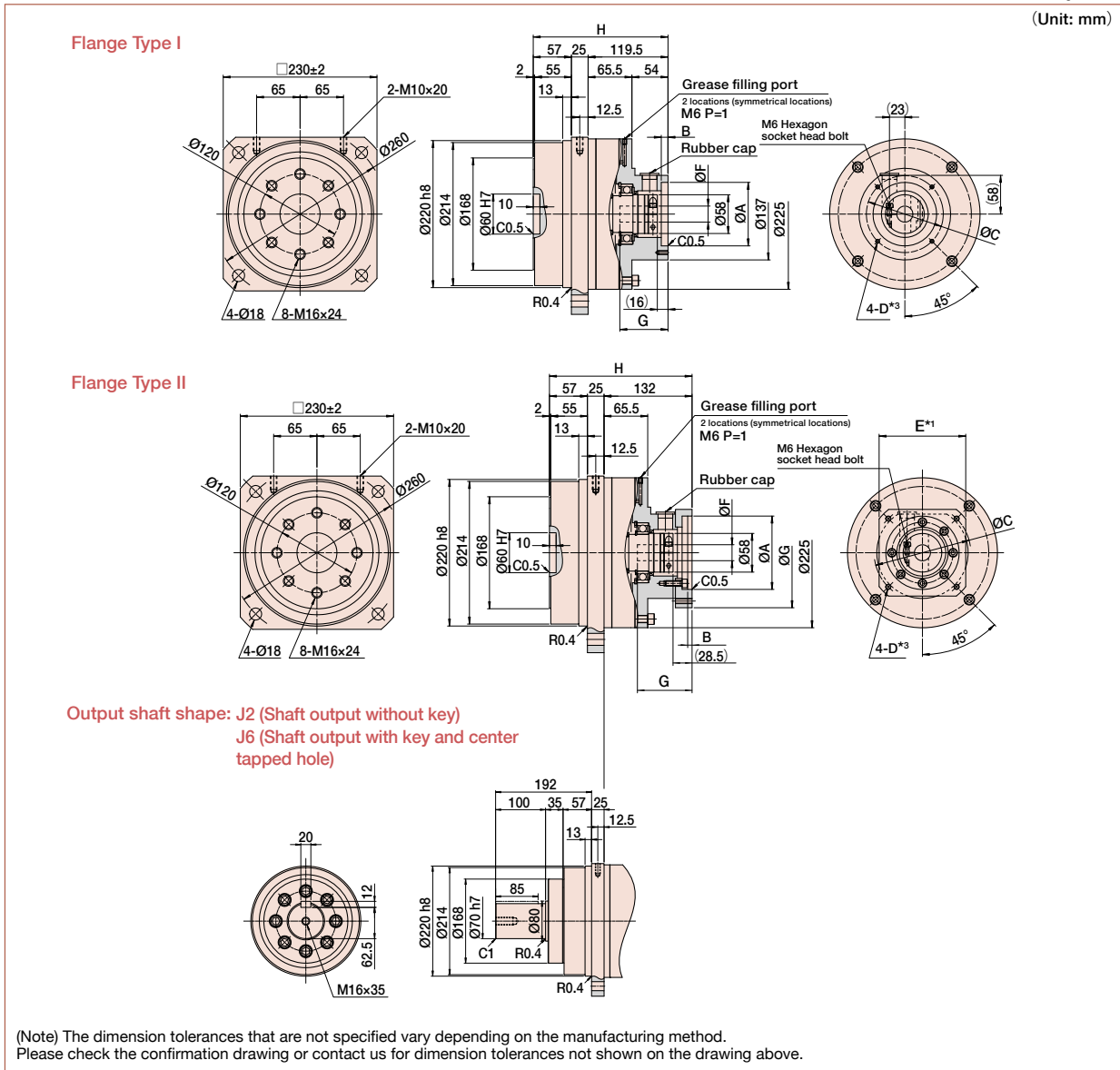

Dimension Table

(Unit: mm) Table 096-1

Flange	Coupling	A (H7) ⁻¹		B ⁻¹	C ⁻¹		F (H7) ⁻¹		G ⁻¹		H ⁻¹	Moment of Inertia (10 ⁻⁴ kgm ²)	Mass (kg) ⁻²	
		Min.	Max.	Max.	Min.	Max.	Min.	Max.	Min.	Max.	Max.		Shaft	Flange
Type I	1	95	110	10	105	125	19.0	39.3	32.0	72	201.5	51	36.2	27.6
Type II	1	70	215	6.5	80	260	19.0	39.3	44.5	84.5	214	51	38.3	29.7

Refer to the confirmation drawing for detailed dimensions.

Dimensions of typical products are shown. Please contact us for other mounting options if the configurations shown above are not suitable for your particular motor.

*1 May vary depending on motor interface dimensions.

*2 The mass will vary slightly depending on the ratio and on the inside diameter of the input shaft coupling.

*3 Tapped hole for motor mounting screw.

Rating Table Definitions

See the corresponding pages of each series for values from the ratings.

Rated torque

Rated torque indicates allowable continuous load torque at input speed.

Limit for Repeated Peak Torque (see Graph 098-1)

During acceleration and deceleration the Harmonic Drive® gear experiences a peak torque as a result of the moment of inertia of the output load. The table indicates the limit for repeated peak torque.

Limit for Average Torque

In cases where load torque and input speed vary, it is necessary to calculate an average value of load torque. The table indicates the limit for average torque. The average torque calculated must not exceed this limit. (calculation formula: Page 103)

Limit for Momentary Torque (see Graph 098-1)

The gear may be subjected to momentary torques in the event of a collision or emergency stop. The magnitude and frequency of occurrence of such peak torques must be kept to a minimum and they should, under no circumstance, occur during normal operating cycle. The allowable number of occurrences of the momentary torque may be calculated by using the formula on page 103.

Maximum Average Input Speed Maximum Input Speed

Do not exceed the allowable rating. (calculation formula of the average input speed: Page 103).

Inertia

The rating indicates the moment of inertia reflected to the gear input.

Example of load torque pattern

Graph 098-1

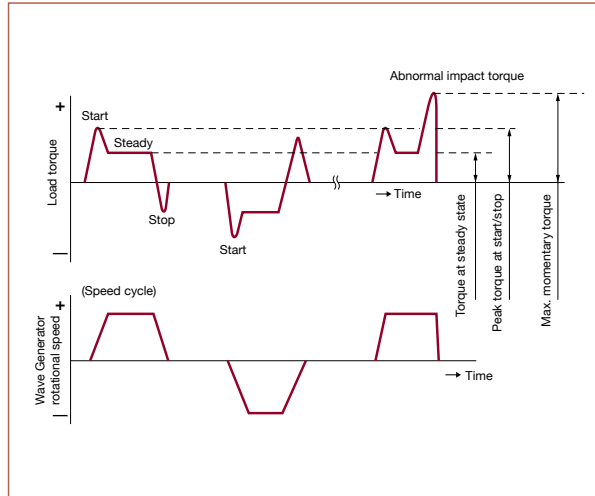

Life

Life of the wave generator

The life of a gear is determined by the life of the wave generator bearing. The life may be calculated by using the input speed and the output load torque.

Table 098-1

Series name	Life	
	CSF-GH	CSG-GH
L ₁₀	7,000 hours	10,000 hours
L ₅₀ (average life)	35,000 hours	50,000 hours

* Life is based on the input speed and output load torque from the ratings.

Calculation formula for Rated Lifetime

Formula 098-1

$$L_h = L_n \cdot \left(\frac{T_r}{T_{av}} \right)^3 \cdot \left(\frac{N_r}{N_{av}} \right)$$

Table 098-2

L _n	Life of L ₁₀ or L ₅₀
T _r	Rated torque
N _r	Rated input speed
T _{av}	Average load torque on the output side (calculation formula: Page 103)
N _{av}	Average input speed (calculation formula: Page 103)

Relative torque rating

Graph 098-2

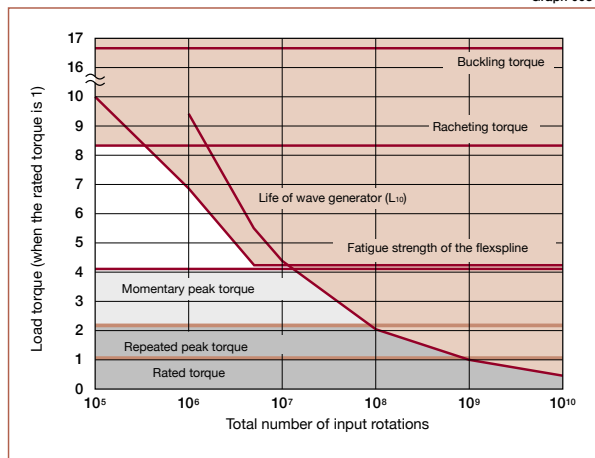

* Lubricant life not taken into consideration in the graph described above.

* Use the graph above as reference values.

Torque Limits

Strength of flexspline

The Flexspline is subjected to repeated deflections, and its strength determines the torque capacity of the Harmonic Drive® gear. The values given for Rated Torque at Rated Speed and for the allowable Repeated Peak Torque are based on an infinite fatigue life for the Flexspline.

The torque that occurs during a collision must be below the momentary torque (impact torque). The maximum number of occurrences is given by the equation below.

Allowable limit of the bending cycles of the flexspline during rotation of the wave generator while the impact torque is applied: 1.0×10^4 (cycles)

The torque that occurs during a collision must be below the momentary torque (impact torque). The maximum number of occurrences is given by the equation below.

Calculation formula

Formula 099-1

$$N = \frac{1.0 \times 10^4}{2 \times \frac{n}{60} \times t}$$

Permissible occurrences	N occurrences
Time that impact torque is applied	t sec
Rotational speed of the wave generator	n rpm
The flexspline bends two times per one revolution of the wave generator.	



If the number of occurrences is exceeded, the Flexspline may experience a fatigue failure.

Buckling torque

When a highly excessive torque (16 to 17 times rated torque) is applied to the output with the input stationary, the flexspline may experience elastic deformation. This is defined as buckling torque.

* See the corresponding pages of each series for buckling torque values.



When the flexspline buckles, early failure of the Harmonic Drive® gear may occur.

Ratcheting torque

When excessive torque (8 to 9 times rated torque) is applied while the gear is in motion, the teeth between the Circular Spline and Flexspline may not engage properly.

This phenomenon is called ratcheting and the torque at which this occurs is called ratcheting torque. Ratcheting may cause the Flexspline to become non-concentric with the Circular Spline. Operating in this condition may result in shortened life and a Flexspline fatigue failure.

* See the corresponding pages of each series for ratcheting torque values.
 * Ratcheting torque is affected by the stiffness of the housing to be used when installing the circular spline. Contact us for details of the ratcheting torque.

When ratcheting occurs, the teeth may not be correctly engaged and become out of alignment as shown in Figure 099-1. Operating the drive in this condition will cause vibration and damage the flexspline.

Once ratcheting occurs, the teeth wear excessively and the ratcheting torque may be lowered.

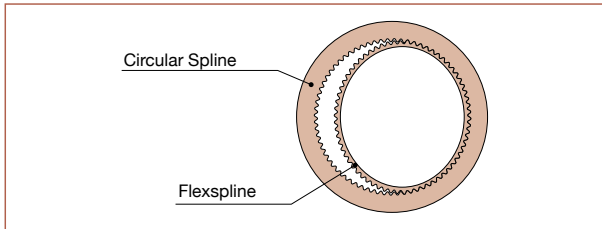

Figure 099-1

"Dedoidal" condition.

Torsional Stiffness

Stiffness and backlash of the drive system greatly affects the performance of the servo system. Please perform a detailed review of these items before designing your equipment and selecting a model number.

Stiffness

Fixing the input side (wave generator) and applying torque to the output side (flexspline) generates torsion almost proportional to the torque on the output side. Figure 098-1 shows the torsional angle at the output side when the torque applied on the output side starts from zero, increases up to $+T_0$ and decreases down to $-T_0$. This is called the "Torque – torsion angle diagram," which normally draws a loop of $0 - A - B - A' - B' - A$. The slope described in the "Torque – torsion angle diagram" is represented as the spring constant for the stiffness of the HarmonicDrive® gear (unit: Nm/rad).

As shown in Figure 100-2, this "Torque – torsional angle diagram" is divided into 3 regions, and the spring constants in the area are represented by K_1 , K_2 and K_3 .

- K_1 ... The spring constant when the torque changes from [zero] to $[T_1]$
- K_2 ... The spring constant when the torque changes from $[T_1]$ to $[T_2]$
- K_3 ... The spring constant when the torque changes from $[T_2]$ to $[T_3]$

- See the corresponding pages of each series for values of the spring constants (K_1 , K_2 , K_3) and the torque-torsional angles (T_1 , T_2 , $-\theta_1$, θ_2).

Example for calculating the torsion angle

The torsion angle (θ) is calculated here using CSG-32-100-GH as an example.

- $T_1 = 29 \text{ Nm}$
- $T_2 = 108 \text{ Nm}$
- $K_1 = 11 \times 10^4 \text{ Nm/rad}$
- $K_2 = 12 \times 10^4 \text{ Nm/rad}$
- $K_3 = 6.7 \times 10^4 \text{ Nm/rad}$
- $\theta_1 = 4.4 \times 10^{-4} \text{ rad}$
- $\theta_2 = 11.6 \times 10^{-4} \text{ rad}$

When the applied torque is T_1 or less, the torsion angle θ_{L1} is calculated as follows:

$$\begin{aligned} \text{When the load torque } T_{L1} &= 6.0 \text{ Nm} \\ \theta_{L1} &= T_{L1}/K_1 \\ &= 6.0/6.7 \times 10^4 \\ &= 9.0 \times 10^{-5} \text{ rad (0.31 arc min)} \end{aligned}$$

When the applied torque is between T_1 and T_2 , the torsion angle θ_{L2} is calculated as follows:

$$\begin{aligned} \text{When the load torque is } T_{L2} &= 50 \text{ Nm} \\ \theta_{L2} &= \theta_1 + (T_{L2} - T_1)/K_2 \\ &= 4.4 \times 10^{-4} + (50 - 29)/11.0 \times 10^4 \\ &= 4.4 \times 10^{-4} + 1.9 \times 10^{-4} \\ &= 6.3 \times 10^{-4} \text{ rad (2.17 arc min)} \end{aligned}$$

When the applied torque is greater than T_2 , the torsion angle θ_{L3} is calculated as follows:

$$\begin{aligned} \text{When the load torque is } T_{L3} &= 178 \text{ Nm} \\ \theta_{L3} &= \theta_1 + \theta_2 + (T_{L3} - T_2)/K_3 \\ &= 4.4 \times 10^{-4} + 11.6 \times 10^{-4} + (178 - 108)/12.0 \times 10^4 \\ &= 4.4 \times 10^{-4} + 11.6 \times 10^{-4} + 5.8 \times 10^{-4} \\ &= 2.18 \times 10^{-3} \text{ rad (7.5 arc min)} \end{aligned}$$

When a bidirectional load is applied, the total torsion angle will be $2 \times \theta_{Lx}$ plus hysteresis loss.

* The torsion angle calculation is for the gear component set only and does not include any torsional windup of the output shaft.

Hysteresis loss

As shown in Figure 098-1, when the applied torque is increased to the rated torque and is brought back to [zero], the torsional angle does not return exactly back to the zero point. This small difference ($B - B'$) is called hysteresis loss.

- See the appropriate page for each model series for the hysteresis loss value.

Torque - torsion angle diagram

Figure 100-1

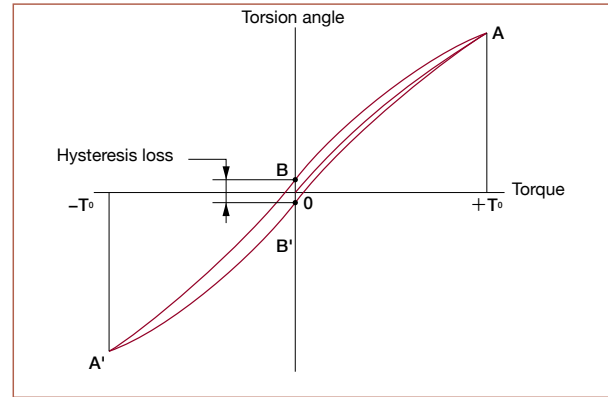

Spring constant diagram

Figure 100-2

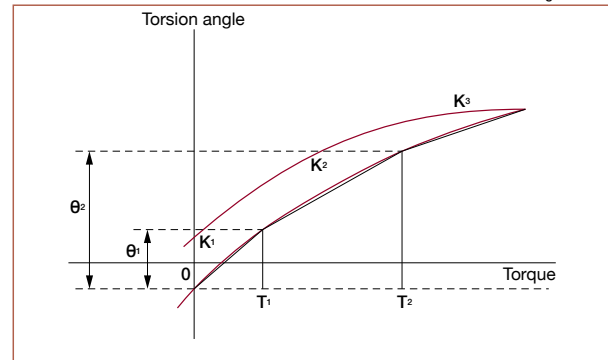

Backlash

Hysteresis loss is primarily caused by internal friction. It is a very small value and will vary roughly in proportion to the applied load. Because HarmonicDrive® gearheads have zero backlash, the only true backlash is due to the clearance in the Oldham coupling, a self-aligning mechanism used on the wave generator. Since the Oldham coupling is used on the input, the backlash measured at the output is extremely small (arc-seconds) since it is divided by the gear reduction ratio.

Vibration

The primary frequency of the transmission error of the HarmonicDrive® gear may rarely cause a vibration of the load inertia. This can occur when the driving frequency of the servo system including the HarmonicDrive® gear is at, or close to the resonant frequency of the system. Refer to the design guide of each series.

The primary component of the transmission error occurs twice per input revolution of the input. Therefore, the frequency generated by the transmission error is 2x the input frequency (rev / sec).

If the resonant frequency of the entire system, including the HarmonicDrive® gear, is F=15 Hz, then the input speed (N) which would generate that frequency could be calculated with the formula below.

Formula 101-1

$$N = \frac{15}{2} \cdot 60 = 450 \text{ rpm}$$

The resonant frequency is generated at an input speed of 450 rpm.

How to the calculate resonant frequency of the system

Formula 101-2

$$f = \frac{1}{2\pi} \sqrt{\frac{K}{J}}$$

Formula variables

Table 101-1

f	The resonant frequency of the system	Hz	
K	Spring constant	Nm/rad	See pages of each series.
J	Load inertia	kgm ²	

Efficiency

The efficiency will vary depending on the following factors:

- Reduction ratio
- Input speed
- Load torque
- Temperature
- Lubrication condition (Type of lubricant and the quantity)

Product Sizing & Selection

In general, a servo system rarely operates at a continuous load and speed. The input rotational speed, load torque change and comparatively large torque are applied at start and stop. Unexpected impact torque may be applied.

These fluctuating load torques should be converted to the average load torque when selecting a model number.

As an accurate cross roller bearing is built in the direct external load support (output flange), the maximum moment load, life of the cross roller bearing and the static safety coefficient should also be checked.

(Note) If HarmonicDrive® CSG-GH or CSF-GH series is installed vertically with the output shaft facing downward (motor mounted above it) and continuously operated in one direction under the constant load state, lubrication failure may occur. In this case, please contact us for details.

Application Motion Profile

Review the application motion profile. Check the specifications shown in the figure below.

Graph 100-1

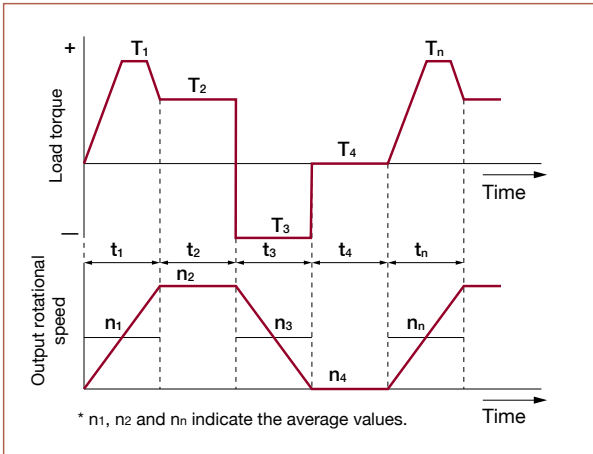

Obtain the value of each application motion profile.

Load torque	T_n (Nm)
Time	t_n (sec)
Output rotational speed	n_n (rpm)

Normal operation pattern

Starting (acceleration)	T_1, t_1, n_1
Steady operation (constant velocity)	T_2, t_2, n_2
Stopping (deceleration)	T_3, t_3, n_3
Idle	T_4, t_4, n_4

Maximum rotational speed

Max. output speed	no_{max}
Max. input rotational speed (Restricted by motors)	ni_{max}

Emergency stop torque

When impact torque is applied	T_s, t_s, n_s
-------------------------------	-----------------

Required life

$$L_{10} = L \text{ (hours)}$$

Flowchart for selecting a size

Please use the flowchart shown below for selecting a size. Operating conditions must not exceed the performance ratings.

Calculate the average load torque applied on the output side from the load torque pattern: T_{av} (Nm).

$$T_{av} = \sqrt[3]{\frac{n_1 \cdot t_1 \cdot |T_1|^3 + n_2 \cdot t_2 \cdot |T_2|^3 + \dots + n_n \cdot t_n \cdot |T_n|^3}{n_1 \cdot t_1 + n_2 \cdot t_2 + \dots + n_n \cdot t_n}}$$

Make a preliminary model selection with the following conditions.

$T_{av} \leq$ Limit for average torque
(See the ratings of each series).

Calculate the average output speed: no_{av} (rpm)

$$no_{av} = \frac{n_1 \cdot t_1 + n_2 \cdot t_2 + \dots + n_n \cdot t_n}{t_1 + t_2 + \dots + t_n}$$

Obtain the reduction ratio (R). A limit is placed on "ni max" by motors.

$$\frac{ni_{max}}{no_{max}} \geq R$$

Calculate the average input rotational speed from the average output rotational speed (no_{av}) and the reduction ratio (R): ni_{av} (rpm)

$$ni_{av} = no_{av} \cdot R$$

Calculate the maximum input rotational speed from the max. output rotational speed (no_{max}) and the reduction ratio (R): ni_{max} (rpm)

$$ni_{max} = no_{max} \cdot R$$

Check whether the preliminary model number satisfies the following condition from the ratings.

$$ni_{av} \leq \text{Limit for average speed (rpm)}$$

$$ni_{max} \leq \text{Limit for maximum speed (rpm)}$$

NG

OK

Check whether T_1 and T_3 are equal to or less than the repeated peak torque specification.

NG

OK

Check whether T_s is equal to or less than the the momentary torque specification.

NG

OK

Calculate (N_s) the allowable number of rotations during impact torque.

$$N_s = \frac{10^4}{2 \cdot \frac{n_s \cdot R}{60} \cdot t} \dots \dots N_s \leq 1.0 \times 10^4$$

NG

OK

Calculate the lifetime.

$$L_{10} = 7,000 \cdot \left(\frac{T_r}{T_{av}} \right)^3 \cdot \left(\frac{nr}{ni_{av}} \right) \text{ (hours)}$$

Check whether the calculated lifetime is equal to or more than the life of the wave generator (see Page 98).

NG

OK

The model number is confirmed.

Review the operation conditions and model number

Example of model number selection

Load torque	T _n (Nm)	Maximum rotational speed	
Time	t _n (sec)	Max. output rotational speed	n _{o max} = 14 rpm
Output rotational speed	n _n (rpm)	Max. input rotational speed (Restricted by motors)	n _{i max} = 1800 rpm
Normal operation pattern		Emergency stop torque	
Starting (acceleration)	T ₁ = 400 Nm, t ₁ = 0.3 sec, n ₁ = 7 rpm	When impact torque is applied	T _s = 500 Nm, t _s = 0.15 sec, n _s = 14 rpm
Steady operation (constant velocity)	T ₂ = 320 Nm, t ₂ = 3 sec, n ₂ = 14 rpm	Required life	
Stopping (deceleration)	T ₃ = 200 Nm, t ₃ = 0.4 sec, n ₃ = 7 rpm	L ₁₀ = 7000 (hours)	
Dwell Idle	T ₄ = 0 Nm, t ₄ = 0.2 sec, n ₄ = 0 rpm		

Calculate the average load torque applied on the output side of the Harmonic Drive® gear from the load torque pattern: **T_{av}** (Nm).

$$T_{av} = 3 \sqrt{\frac{7 \text{ rpm} \cdot 0.3 \text{ sec} \cdot |400 \text{ Nm}|^3 + 14 \text{ rpm} \cdot 3 \text{ sec} \cdot |320 \text{ Nm}|^3 + 7 \text{ rpm} \cdot 0.4 \text{ sec} \cdot |200 \text{ Nm}|^3}{7 \text{ rpm} \cdot 0.3 \text{ sec} + 14 \text{ rpm} \cdot 3 \text{ sec} + 7 \text{ rpm} \cdot 0.4 \text{ sec}}}$$

Make a preliminary model selection with the following conditions. **T_{av}** = 319 Nm ≤ 620 Nm
(Limit for average torque for model number CSF-45-120-GH: See the ratings on Page 89.)
Thus, **CSF-45-120-GH** is tentatively selected.

Calculate the average output rotational speed: n_{o av} (rpm)

$$n_{o av} = \frac{7 \text{ rpm} \cdot 0.3 \text{ sec} + 14 \text{ rpm} \cdot 3 \text{ sec} + 7 \text{ rpm} \cdot 0.4 \text{ sec}}{0.3 \text{ sec} + 3 \text{ sec} + 0.4 \text{ sec} + 0.2 \text{ sec}} = 12 \text{ rpm}$$

Obtain the reduction ratio (R).

$$\frac{1800 \text{ rpm}}{14 \text{ rpm}} = 128.6 \geq 120$$

Calculate the average input rotational speed from the average output rotational speed (n_{o av}) and the reduction ratio (R): n_{i av} (rpm)

$$n_{i av} = 12 \text{ rpm} \cdot 120 = 1440 \text{ rpm}$$

Calculate the maximum input rotational speed from the maximum output rotational speed (n_{o max}) and the reduction ratio (R): n_{i max} (rpm)

$$n_{i max} = 14 \text{ rpm} \cdot 120 = 1680 \text{ rpm}$$

Check whether the preliminary selected model number satisfies the following condition from the ratings.

$$n_{i av} = 1440 \text{ rpm} \leq 3000 \text{ rpm} \text{ (Max average input speed of size 45)}$$

$$n_{i max} = 1680 \text{ rpm} \leq 3800 \text{ rpm} \text{ (Max input speed of size 45)}$$

NG

OK

Check whether T₁ and T₃ are equal to or less than the repeated peak torque specification.

$$T_1 = 400 \text{ Nm} \leq 823 \text{ Nm} \text{ (Limit of repeated peak torque of size 45)}$$

$$T_3 = 200 \text{ Nm} \leq 823 \text{ Nm} \text{ (Limit of repeated peak torque of size 45)}$$

NG

OK

Check whether T_s is equal to or less than the momentary torque specification.

$$T_s = 500 \text{ Nm} \leq 1760 \text{ Nm} \text{ (Limit for momentary torque of size 45)}$$

NG

OK

Calculate the allowable number (N_s) rotation during impact torque and confirm ≤ 1.0×10⁴

$$N_s = \frac{10^4}{2 \cdot \frac{14 \text{ rpm} \cdot 120}{60} \cdot 0.15 \text{ sec}} = 1190 \leq 1.0 \times 10^4$$

NG

OK

Calculate the lifetime.

$$L_{10} = 7000 \cdot \left(\frac{402 \text{ Nm}}{319 \text{ Nm}} \right)^3 \cdot \left(\frac{2000 \text{ rpm}}{1440 \text{ rpm}} \right) \text{ (hours)}$$

Check whether the calculated life is equal to or more than the life of the wave generator (see Page 98).

$$L_{10} = 19,457 \text{ hours} \geq 7000 \text{ (life of the wave generator: } L_{10})$$

NG

OK

The selection of model number **CSF-45-120-GH** is confirmed from the above calculations.

Review: the operation conditions and model number

HarmonicDrive® CSG/CSF-GH Series

HarmonicDrive® gearing has a unique operating principle which utilizes the elastic mechanics of metals. This precision gear reducer consists of only 3 basic parts and provides high accuracy and repeatability.



Wave Generator

The Wave Generator is a thin raced ball bearing fitted onto an elliptical shaped hub. The inner race of the bearing is fixed to the cam and the outer race is elastically deformed into an ellipse via the balls. The Wave Generator is usually mounted onto the input shaft.

Flexspline

The Flexspline is a non-rigid, thin cylindrical cup with external teeth. The Flexspline fits over the Wave Generator and takes on its elliptical shape. The Flexspline is generally used as the output of the gear.

Circular Spline

The Circular Spline is a rigid ring with internal teeth, engaging the teeth of the Flexspline across the major axis of the Wave Generator. The Circular Spline has two more teeth than the Flexspline and is generally mounted to the housing.

The greatest benefit of HarmonicDrive® gearing is the weight and space savings compared to other gearheads because it consists of only three basic parts. Since many teeth are engaged simultaneously, it can transmit higher torque and provides high accuracy. A unique S tooth profile significantly improves torque capacity, life and torsional stiffness of the gear.

- ◆ Zero-backlash
- ◆ High Reduction ratios, 50:1 to 160:1 in a single stage
- ◆ High precision positioning (repeatability ± 4 to ± 10 arc-sec)
- ◆ High capacity cross roller output bearing
- ◆ High torque capacity

Sold & Serviced by:

 **ELECTROMATE**

Toll Free Phone: (877) SERV098
Toll Free Fax: (877) SERV099

www.electromate.com
sales@electromate.com

Robust cross roller bearing is integrated with the output flange to provide high moment stiffness, high load capacity and precise positioning accuracy.

Flexspline

Shielded bearing

Motor mounting flange

Wave Generator

Circular Spline

Quick Connect® servo coupling machined and balanced to match the motor shaft diameter (single bolt clamping design)

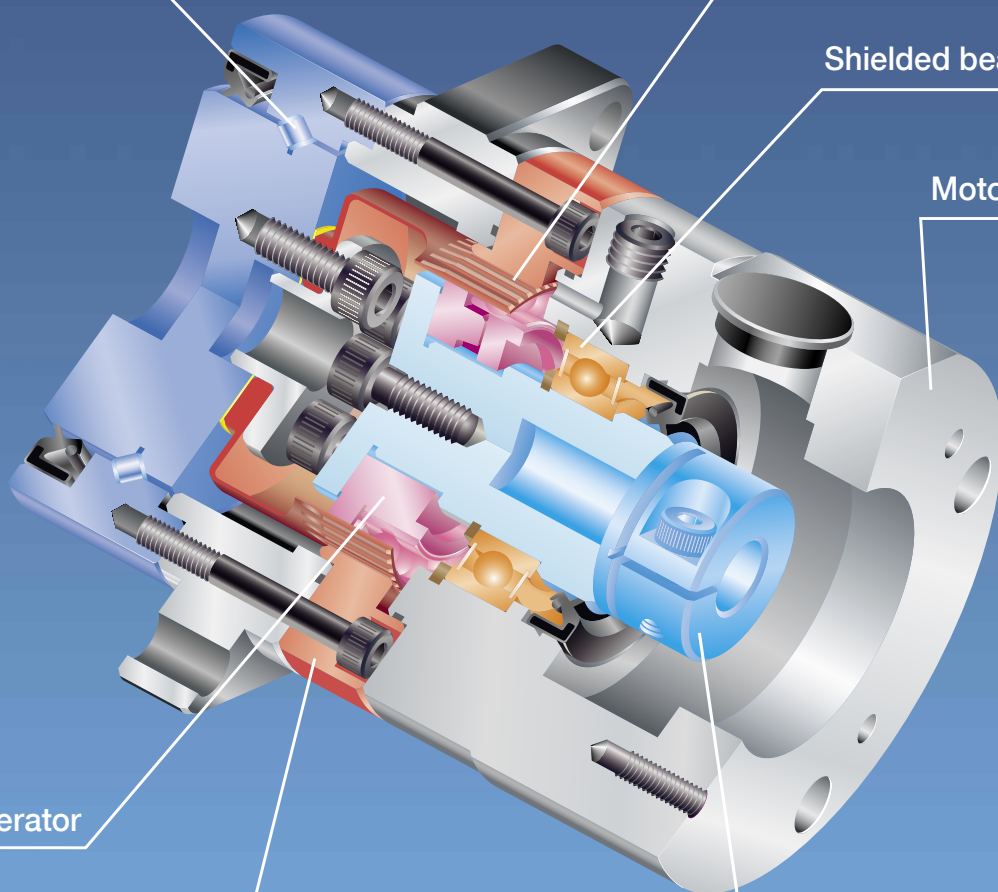

Sold & Serviced by:

 **ELECTROMATE**

Toll Free Phone: (877) SERV098
Toll Free Fax: (877) SERV099

www.electromate.com
sales@electromate.com



Harmonic Planetary®

Harmonic Drive®

Technical Information

Efficiency	126
Output Bearing Specifications and Checking Procedure	145
Input Bearing Specifications and Checking Procedure	149

Product Handling

Assembly	151
Mechanical Tolerances	154
Lubrication	155
Warranty, Disposal	157
Safety	158

The rated value and performance vary depending on the product series.
Be sure to check the usage conditions and refer to the items conforming
to the related product.

Efficiency

In general, the efficiency of a speed reducer depends on the reduction ratio, input rotational speed, load torque, temperature and lubrication condition. The efficiency of each series under the following measurement conditions is plotted in the graphs on the next page. The values in the graph are average values.

Measurement condition

Table 126-1

Input rotational speed	HPGP / HPG / HPF / HPN: 3000rpm CSG-GH / CSF-GH: Indicated on each efficiency graph.
Ambient temperature	25°C
Lubricant	Use standard lubricant for each model. (See pages 155- 156 for details.)

Efficiency compensated for low temperature

Calculate the efficiency at an ambient temperature of 25°C or less by multiplying the efficiency at 25°C by the low-temperature efficiency correction value. Obtain values corresponding to an ambient temperature and to an input torque (TRi*) from the following graphs when calculating the low-temperature efficiency correction value.

HPGP

HPG

HPF

HPN

* TRi is an input torque corresponding to output torque at 25°C.

Graph 126-1

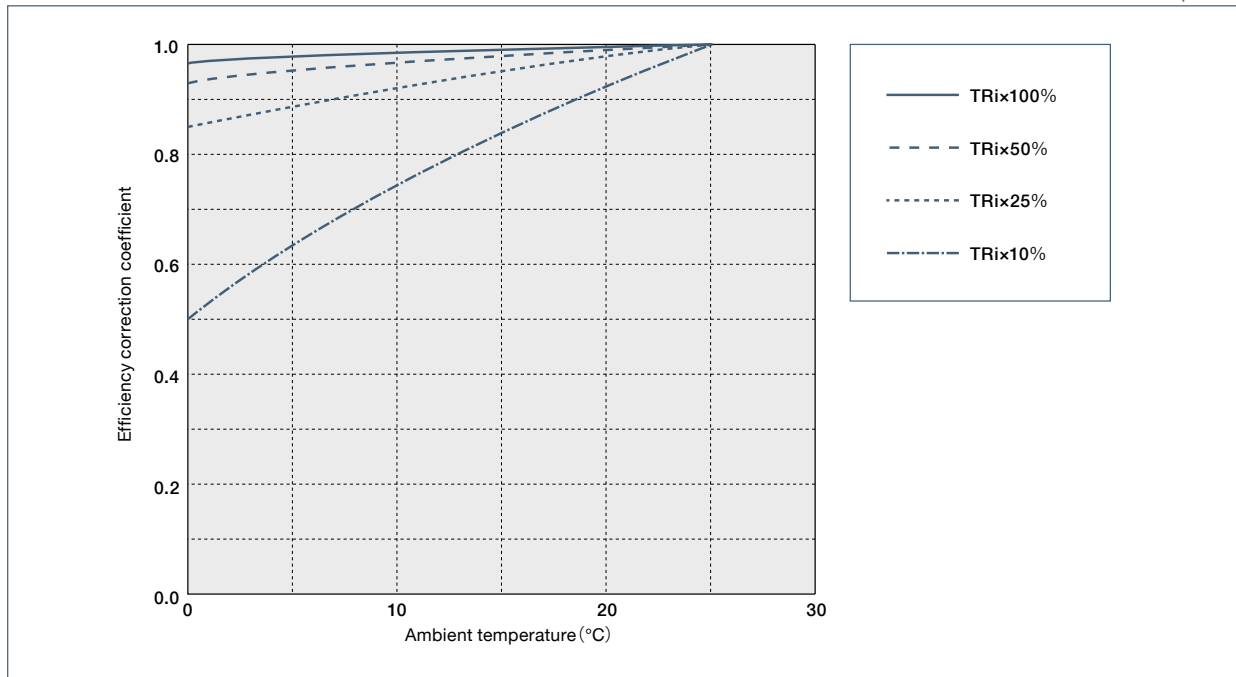

CSG-GH

CSF-GH

* TRi is an input torque corresponding to output torque at 25°C.

Graph 126-2

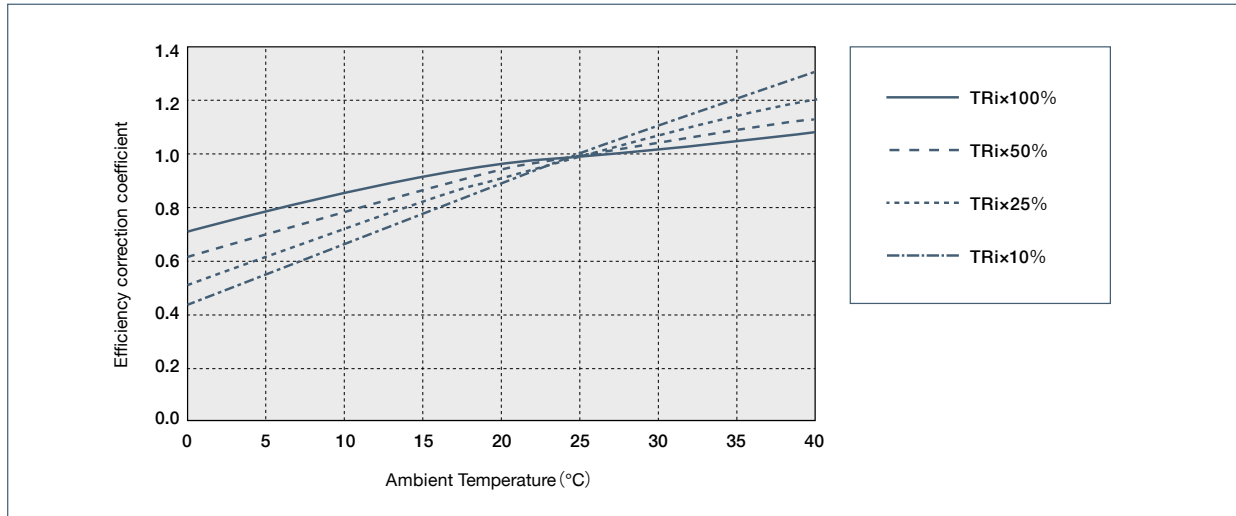

Size 11 : Gearhead

HPGP

Reduction Ratio = 5

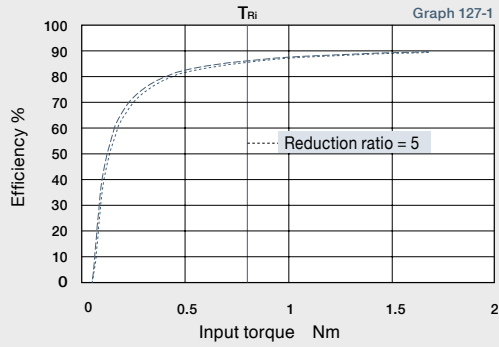

Reduction Ratio = 21

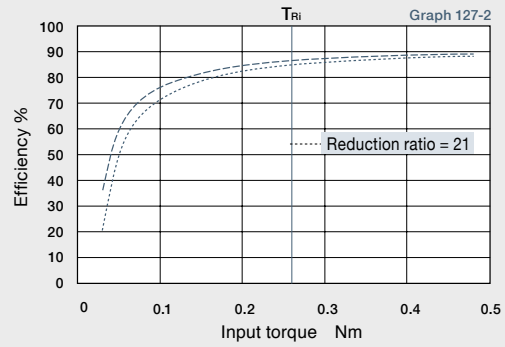

Reduction Ratio = 37, 45

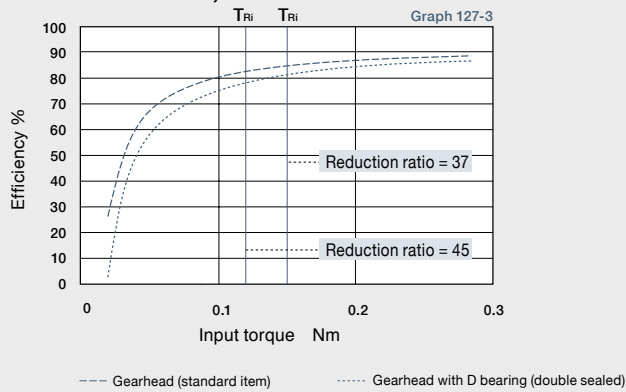

Size 14 : Gearhead

HPGP

Reduction Ratio = 5

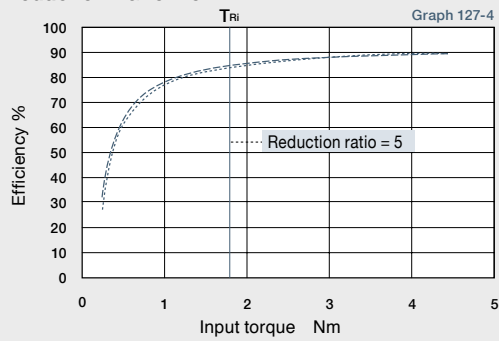

Reduction Ratio = 11

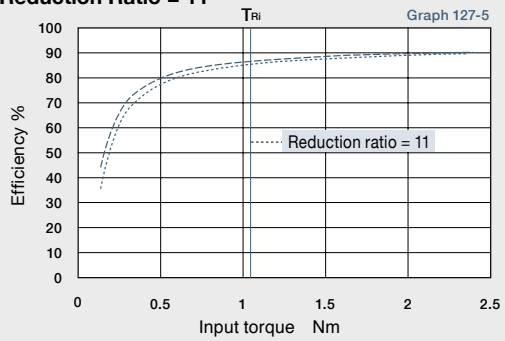

Reduction Ratio = 15, 21

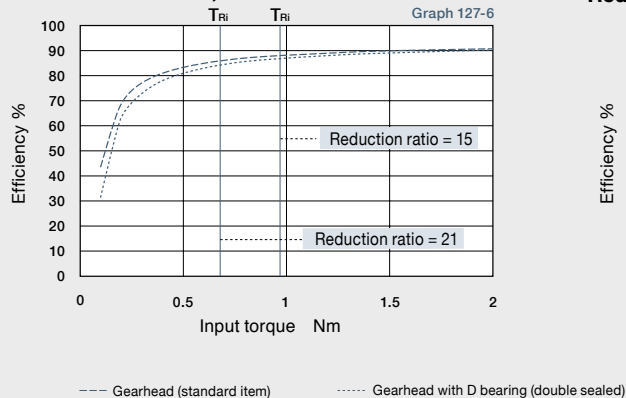

Reduction Ratio = 33, 45

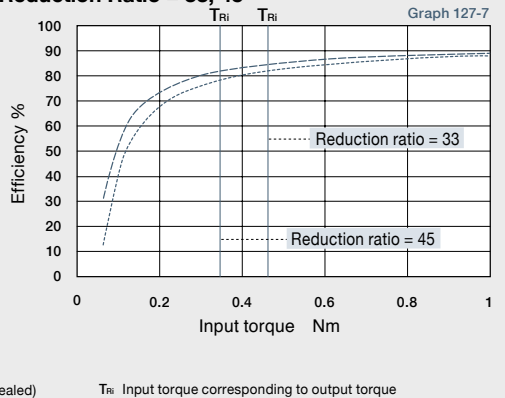

Size 20 : Gearhead

HPGP

Reduction ratio = 5

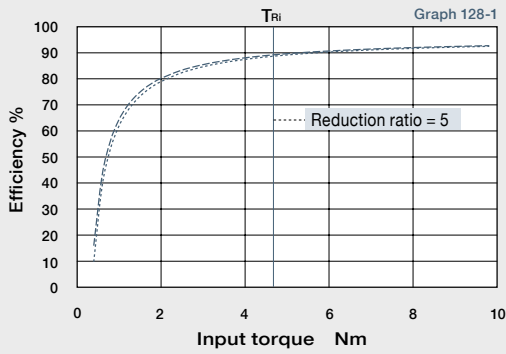

Reduction ratio = 11

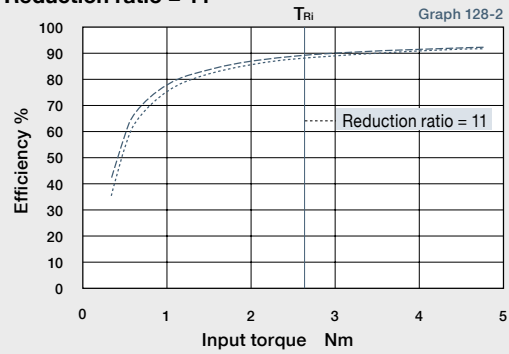

Reduction ratio = 15, 21

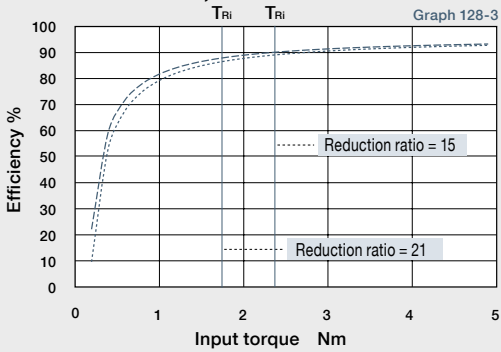

Reduction ratio = 33, 45

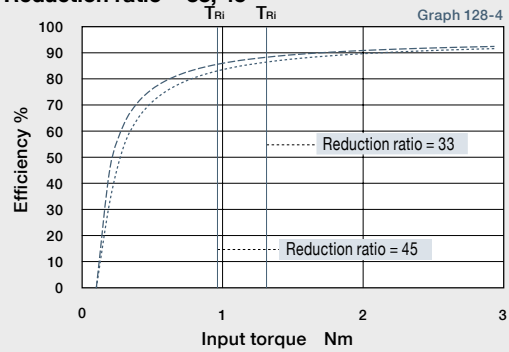

--- Gearhead (standard item)

----- Gearhead with D bearing (double sealed)

T_{Ri} Input torque corresponding to output torque

Size 32 : Gearhead

HPGP

Reduction ratio = 5 *1

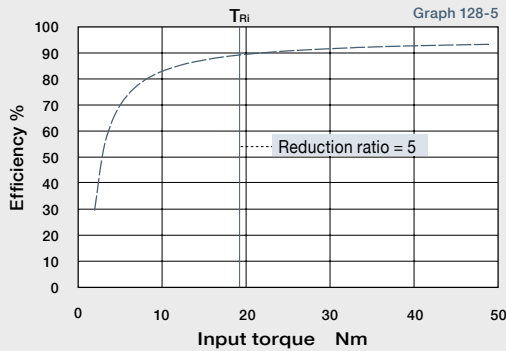

Reduction ratio = 11

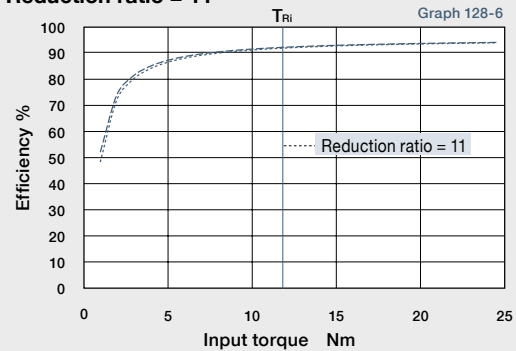

Reduction ratio = 15, 21

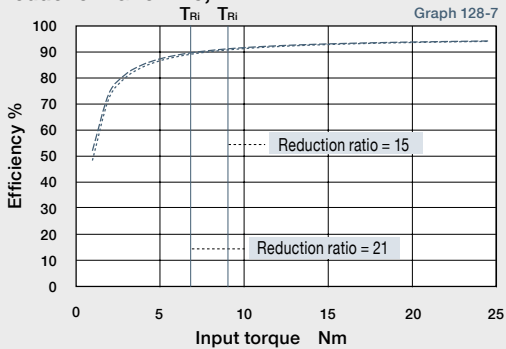

Reduction ratio = 33, 45

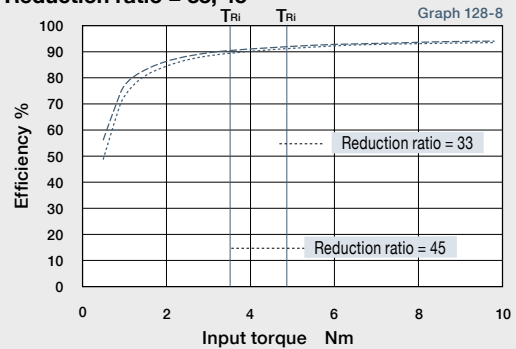

--- Gearhead (standard item)

----- Gearhead with D bearing (double sealed)

T_{Ri} Input torque corresponding to output torque

*1 Only one line is shown because the difference between the gearhead and a bearing assembled on the input side is small.

Size 50 : Gearhead

HPGP

Reduction ratio = 5 *2

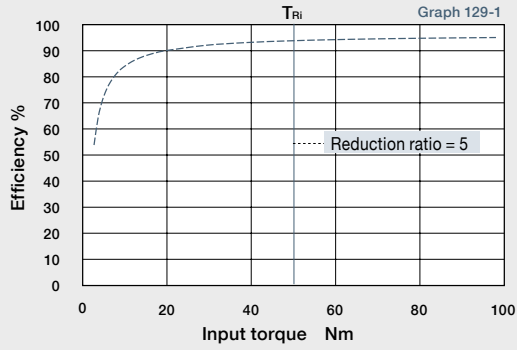

Reduction ratio = 11 *2

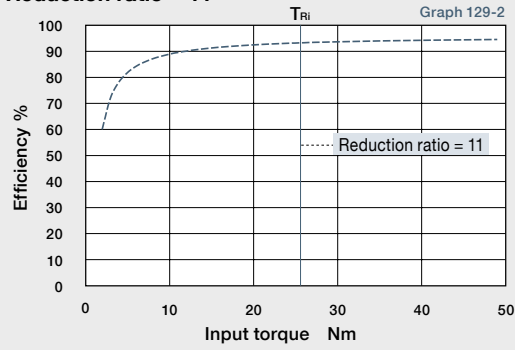

Reduction ratio = 15, 21 *2

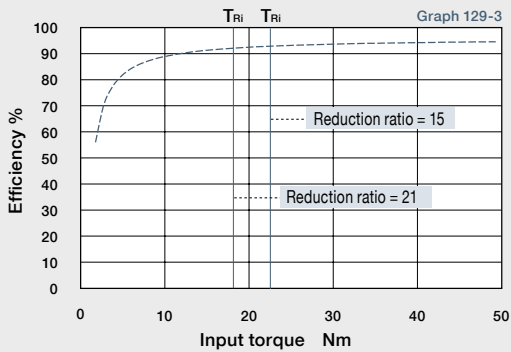

Reduction ratio = 33, 45

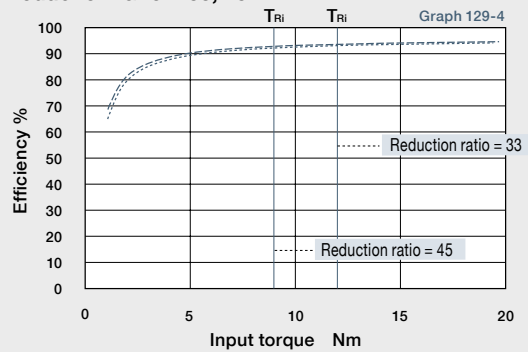

--- Gearhead (standard item)

..... Gearhead with D bearing (double sealed)

T_{Ri} Input torque corresponding to output torque

*2 Only one line is shown because the difference between the gearhead and a bearing assembled on the input side is small.

Size 65 : Gearhead

HPGP

Reduction ratio = 4, 5 *3

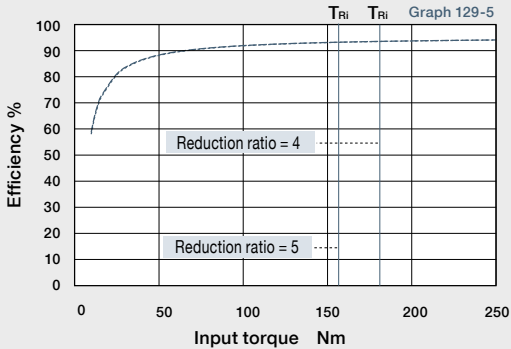

Reduction ratio = 12 *3

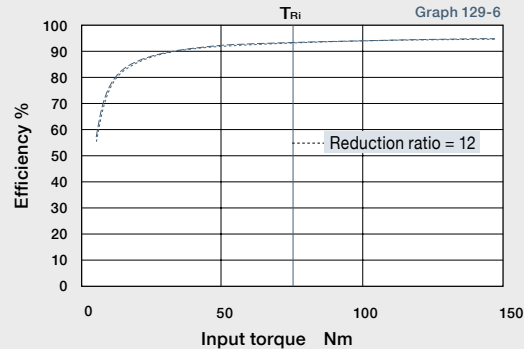

Reduction ratio = 15, 20 *3

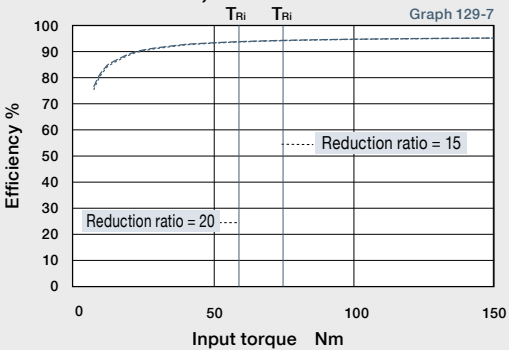

Reduction ratio = 25 *3

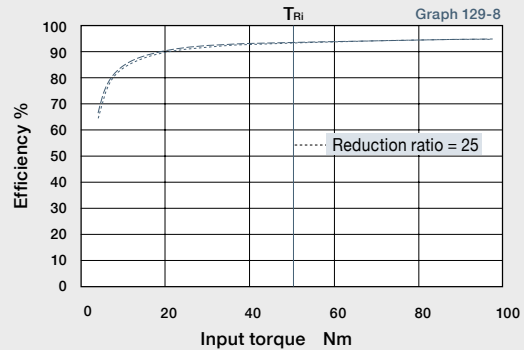

--- Gearhead (standard item)

..... Gearhead with D bearing (double sealed)

T_{Ri} Input torque corresponding to output torque

*3 Only one line is shown because the difference between the gearhead and a bearing assembled on the input side is small.

Size 11 : Gearhead & Input Shaft Unit

HPG

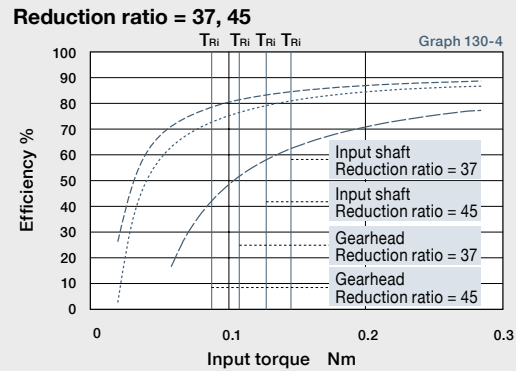
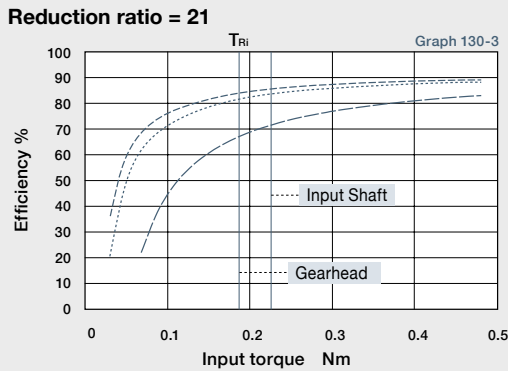
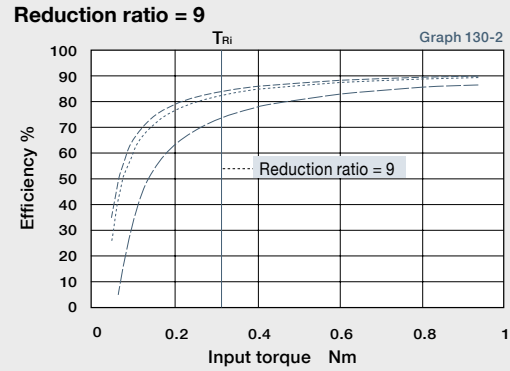
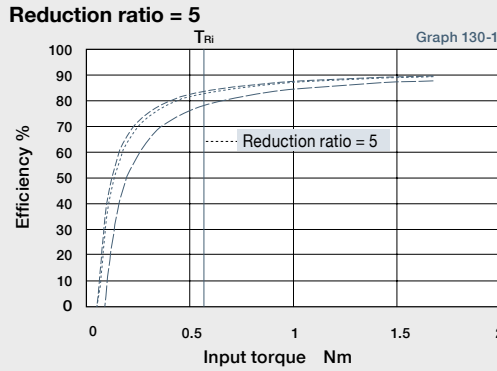

--- Gearhead (standard item)

----- Gearhead with D bearing (double sealed)

T_{Ri} Input torque corresponding to output torque

Size 14 : Gearhead & Input Shaft Unit

HPG

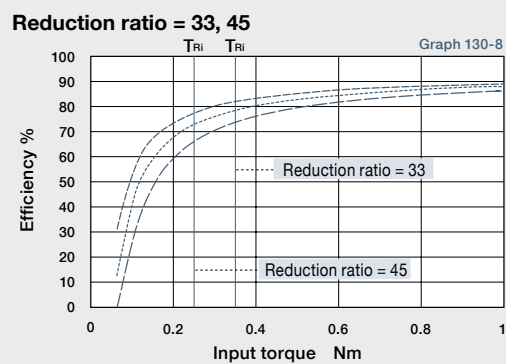
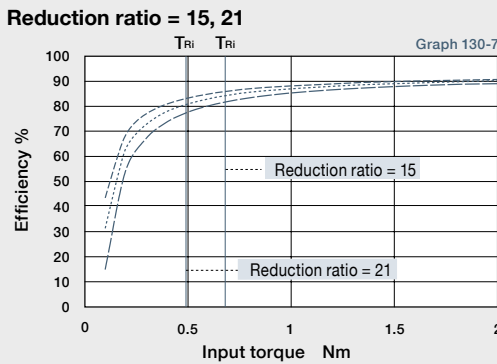
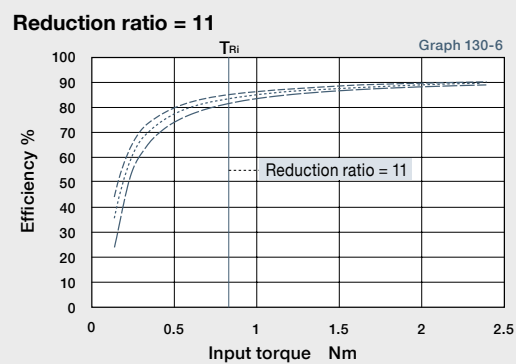
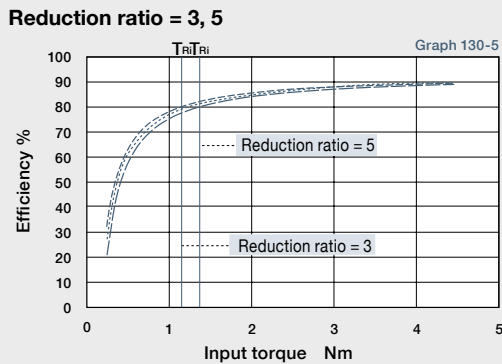

--- Gearhead (standard item)

----- Gearhead with D bearing (double sealed)

T_{Ri} Input torque corresponding to output torque

Size 20 : Gearhead & Input Shaft Unit

HPG

Reduction ratio = 3, 5

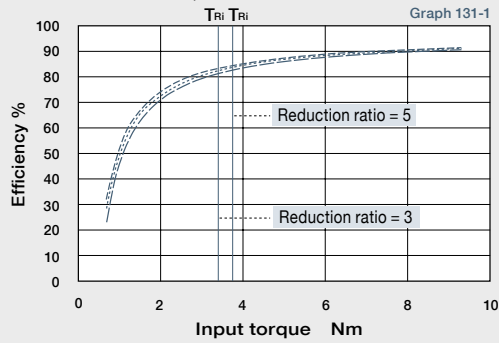

Reduction ratio = 11

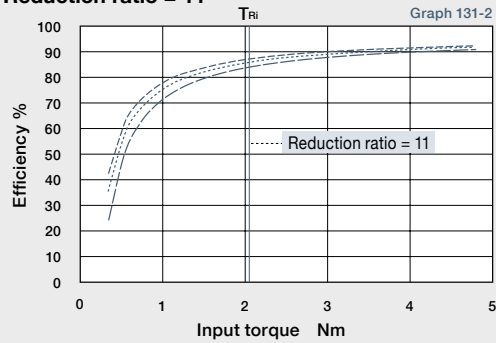

Reduction ratio = 15, 21

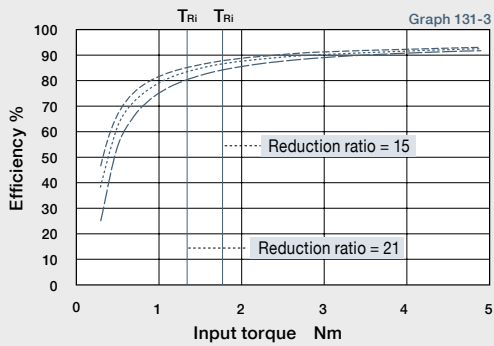

Reduction ratio = 33, 45

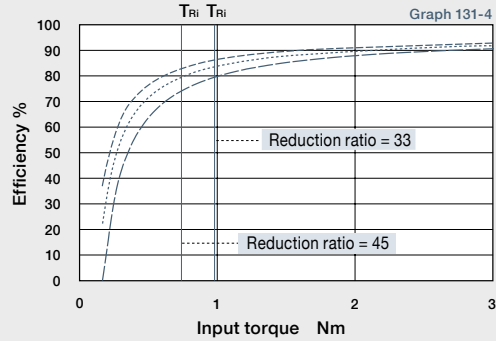

--- Gearhead (standard item) - - - - Gearhead with D bearing (double sealed) — Input Shaft T_{Ri} Input torque corresponding to output torque

Size 32 : Gearhead & Input Shaft Unit

HPG

Reduction ratio = 3, 5*1

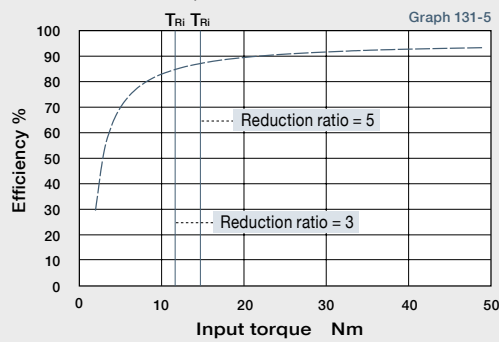

Reduction ratio = 11

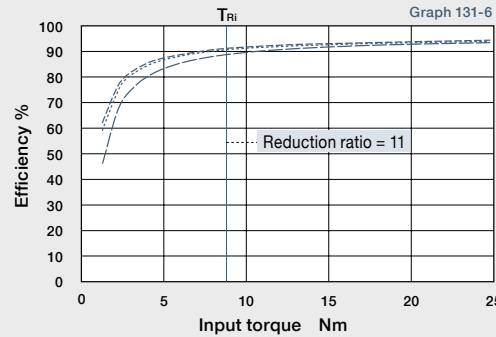

Reduction ratio = 15, 21

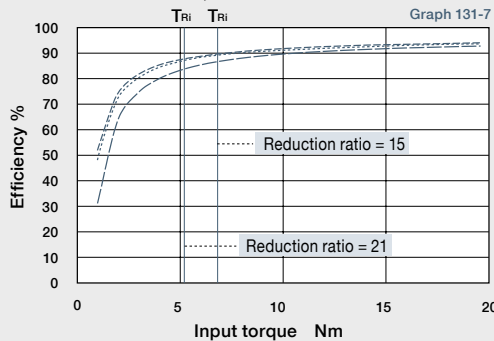

Reduction ratio = 33, 45

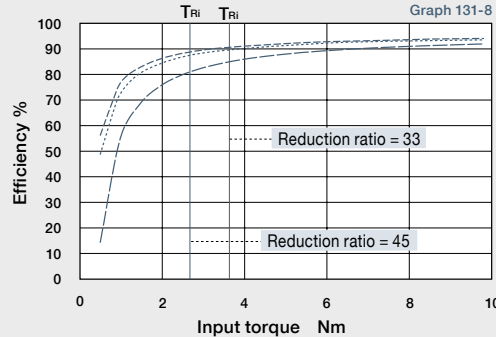

--- Gearhead (standard item) - - - - Gearhead with D bearing (double sealed) — Input Shaft T_{Ri} Input torque corresponding to output torque

*1 Only one line is shown because the difference between the gearhead and a bearing assembled on the input side is small.

Size 50 : Gearhead & Input Shaft Unit

HPG

Reduction ratio = 3, 5*2

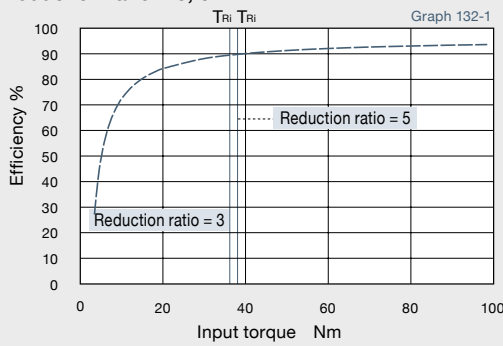

Reduction ratio = 11*2

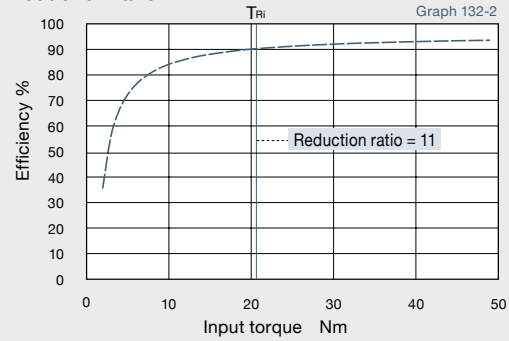

Reduction ratio = 15, 21*2

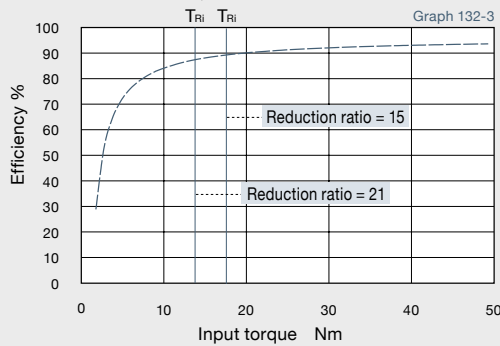

Reduction ratio = 33, 45

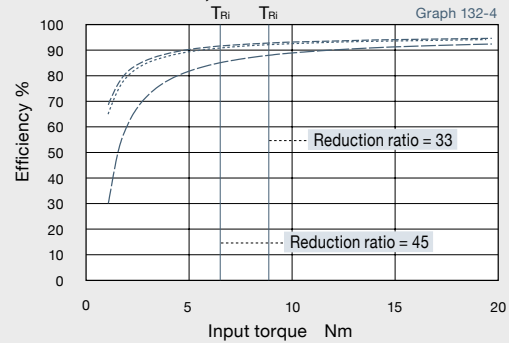

--- Gearhead (standard item) - - - - Gearhead with D bearing (double sealed) — Input Shaft T_{Ri} Input torque corresponding to output torque

*2 Only one line is shown because the difference between the gearhead and a bearing assembled on the input side is small.

Size 65 : Gearhead & Input Shaft Unit

HPG

Reduction ratio = 4, 5*3

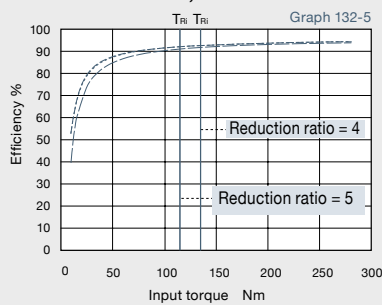

Reduction ratio = 12

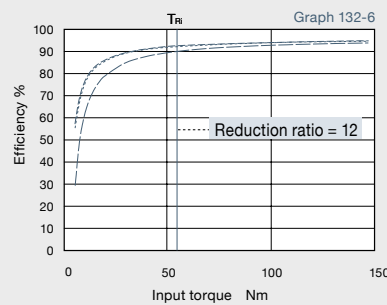

Reduction ratio = 15, 20

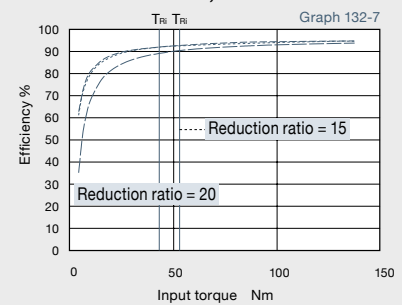

Reduction ratio = 25

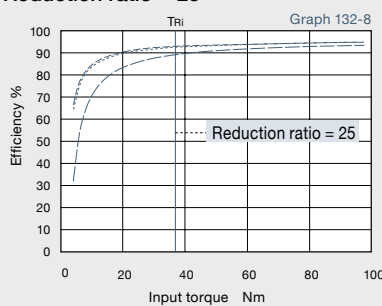

Reduction ratio = 40*3

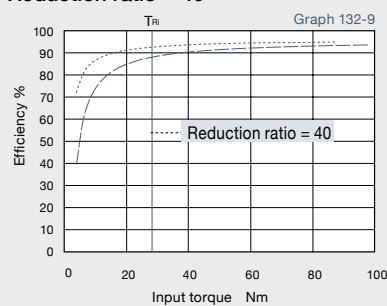

Reduction ratio = 50

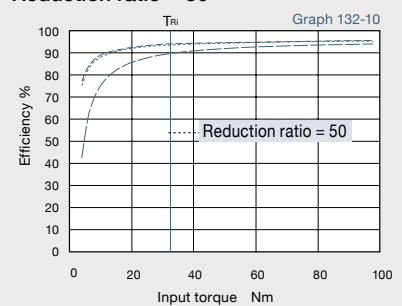

--- Gearhead (standard item) - - - - Gearhead with D bearing (double sealed) — Input Shaft T_{Ri} Input torque corresponding to output torque

*3 Only one line is shown because the difference between the gearhead and a bearing assembled on the input side is small.

Size 32 RA3 : Right Angle Gearhead

HPG

Reduction ratio = 5

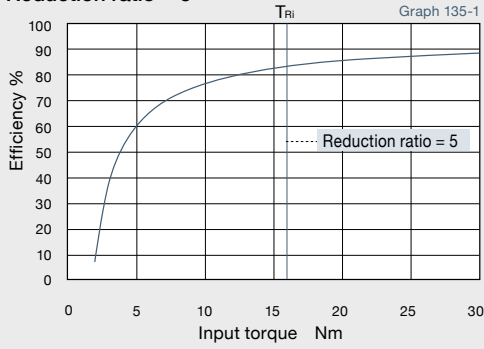

Reduction ratio = 11

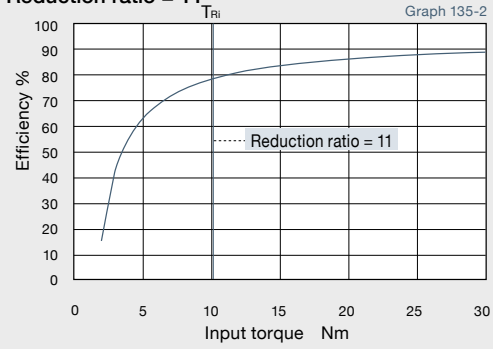

Reduction ratio = 15, 21

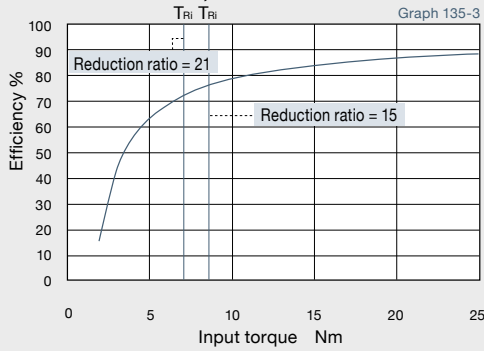

Reduction ratio = 33, 45

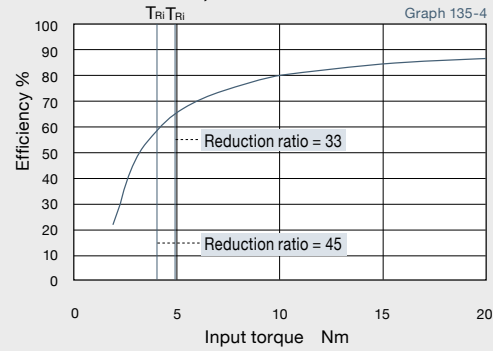

T_{Ri} Input torque corresponding to output torque

Size 50 RA3 : Right Angle Gearhead

HPG

Reduction ratio = 5

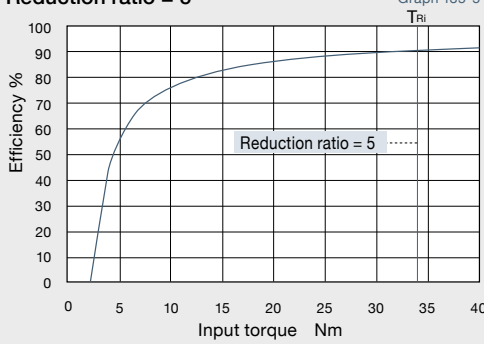

Reduction ratio = 11

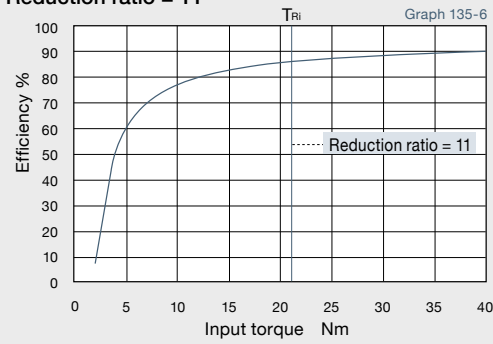

Reduction ratio = 15, 21

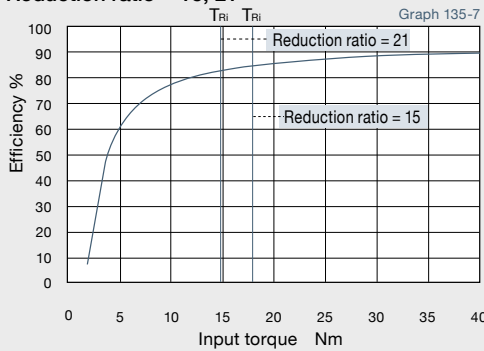

Reduction ratio = 33, 45

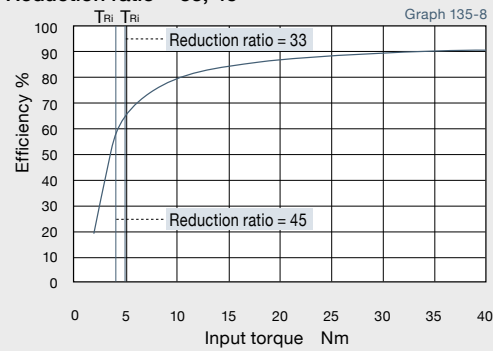

T_{Ri} Input torque corresponding to output torque

Size 50 RA5 : Right Angle Gearhead

HPG

Reduction ratio = 5

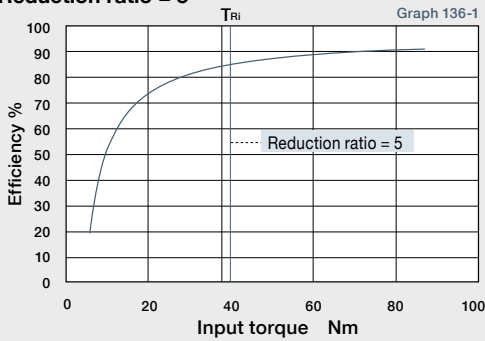

Reduction ratio = 11

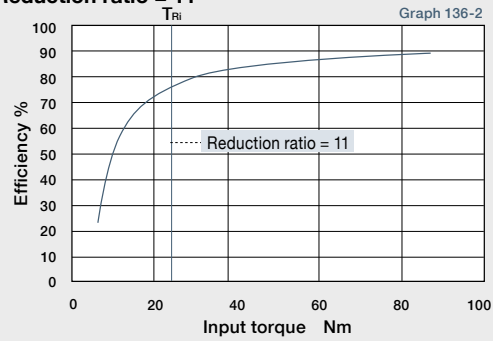

Reduction ratio = 15, 21

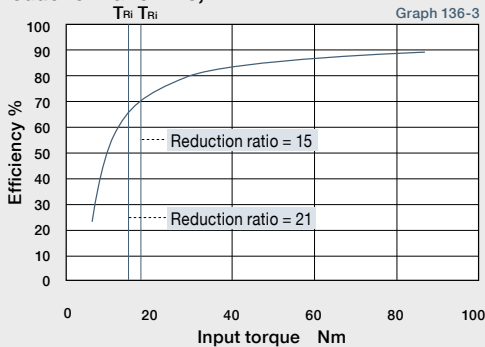

Reduction ratio = 33, 45

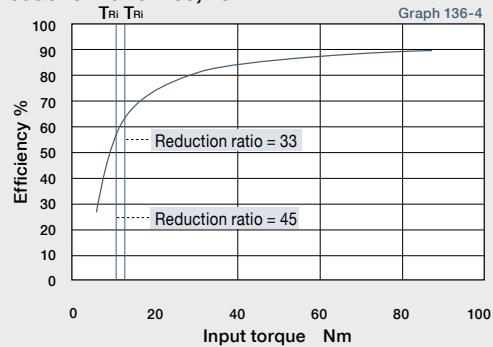

T_{Ri} Input torque corresponding to output torque

Size 65 RA5 : Right Angle Gearhead

HPG

Reduction ratio = 5

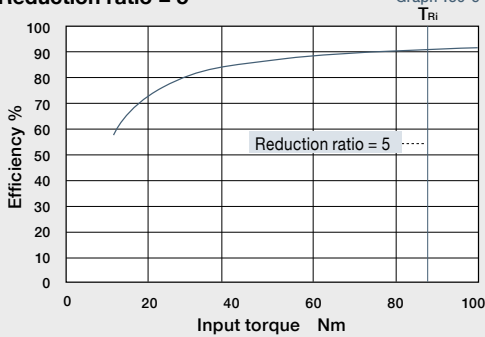

Reduction ratio = 12, 15

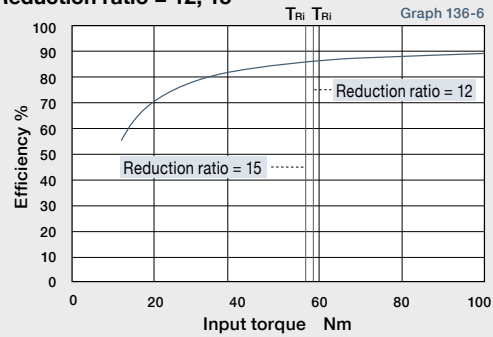

Reduction ratio = 20, 25

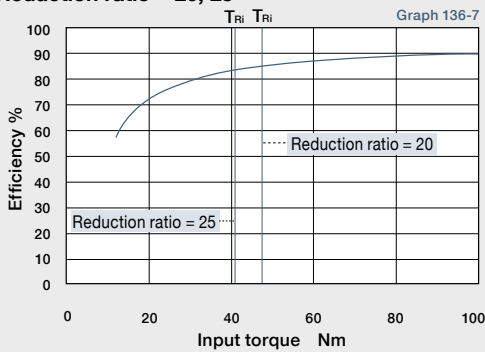

Reduction ratio = 40, 50

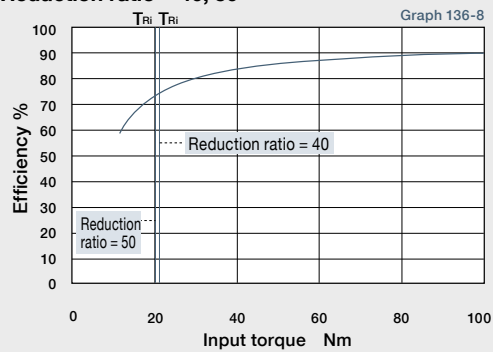

T_{Ri} Input torque corresponding to output torque

Size 11A : Gearhead

HPN

Reduction ratio = 4

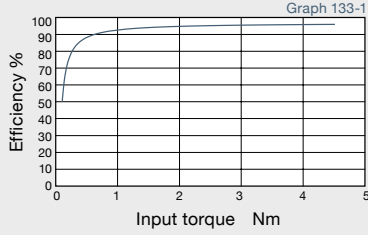

Reduction ratio = 5

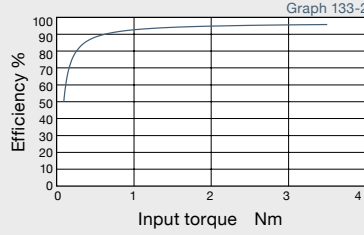

Reduction ratio = 7

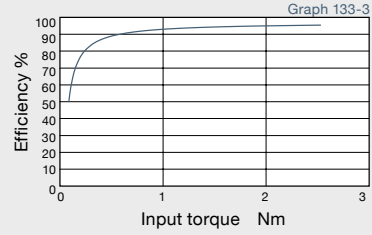

Reduction ratio = 10

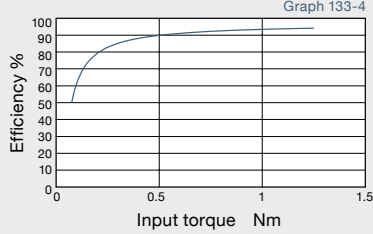

Reduction ratio = 16

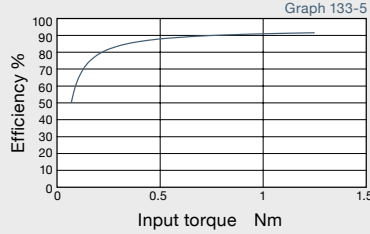

Reduction ratio = 20

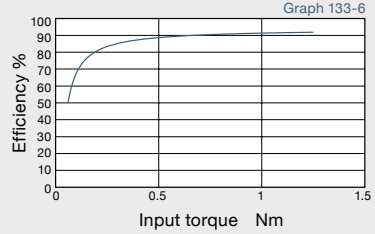

Reduction ratio = 30

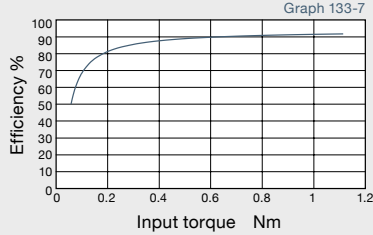

Size 14A : Gearhead

HPN

Reduction ratio = 3

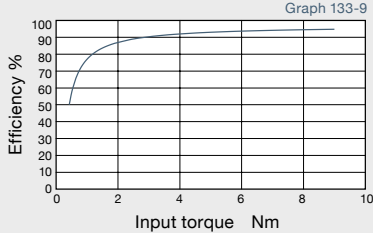

Reduction ratio = 4

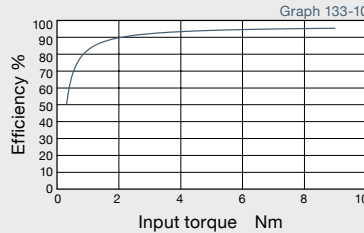

Reduction ratio = 5

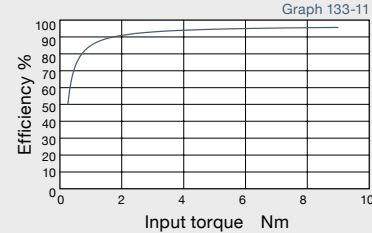

Reduction ratio = 7

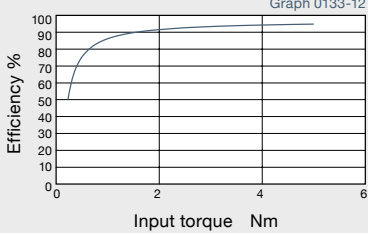

Reduction ratio = 10

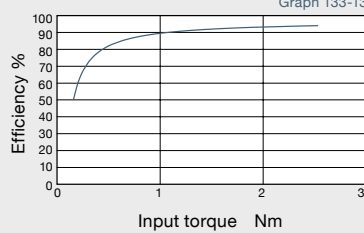

Reduction ratio = 13

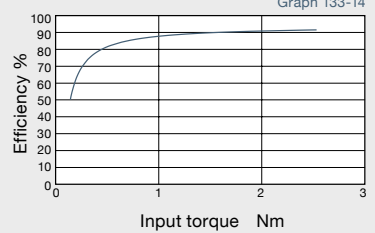

Reduction ratio = 21

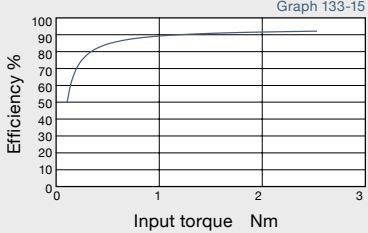

Reduction ratio = 31

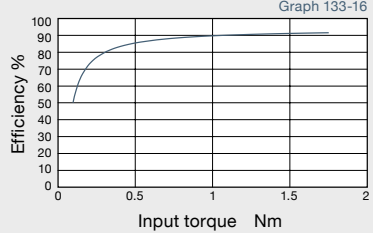

Size 20A : Gearhead

HPN

Reduction ratio = 3

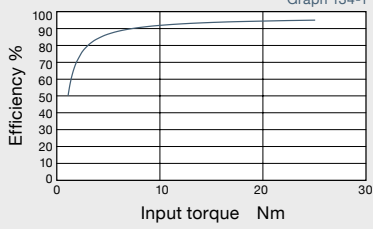

Reduction ratio = 4

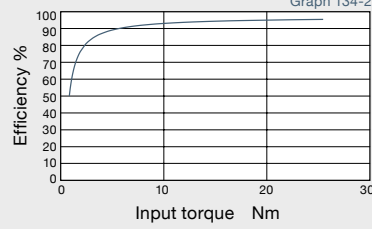

Reduction ratio = 5

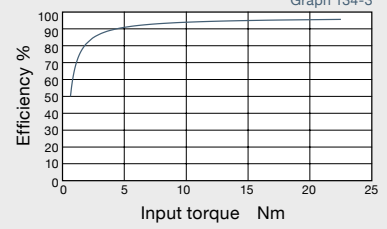

Reduction ratio = 7

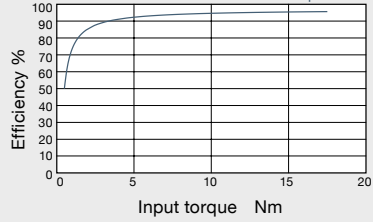

Reduction ratio = 10

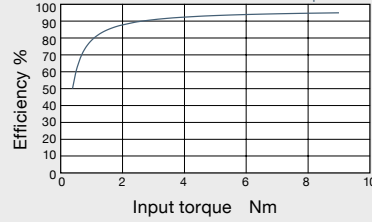

Reduction ratio = 13

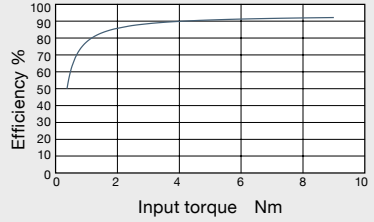

Reduction ratio = 21

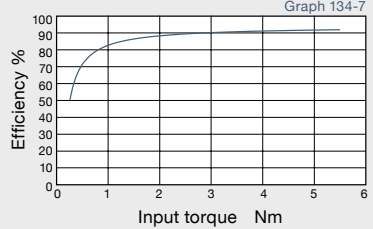

Reduction ratio = 31

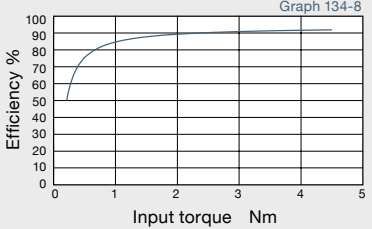

Size 32A : Gearhead

HPN

Reduction ratio = 3

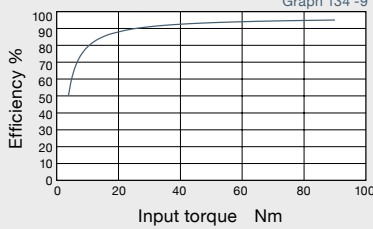

Reduction ratio = 4

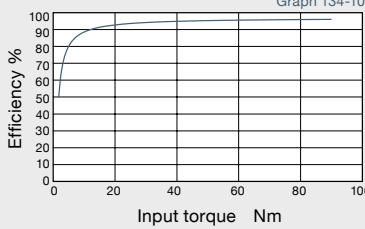

Reduction ratio = 5

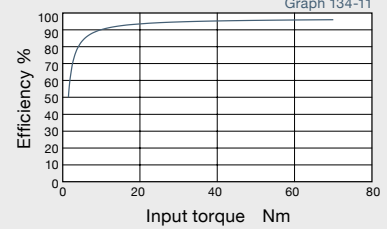

Reduction ratio = 7

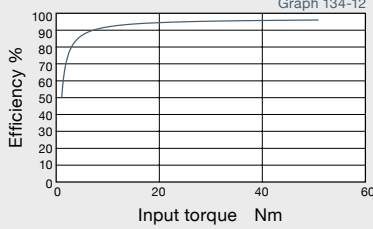

Reduction ratio = 10

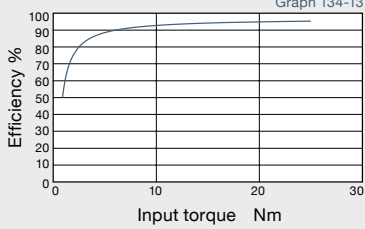

Reduction ratio = 13

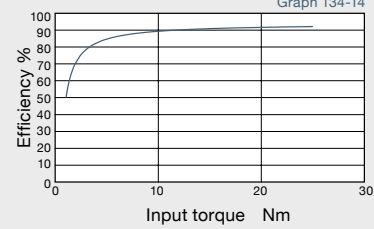

Reduction ratio = 21

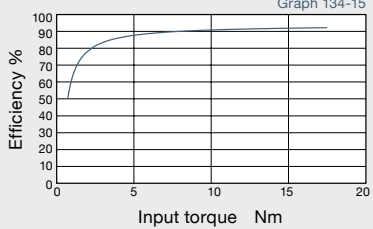

Reduction ratio = 31

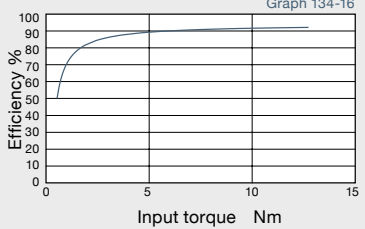

Size 40A

: Gearhead

HPN

Reduction ratio = 3

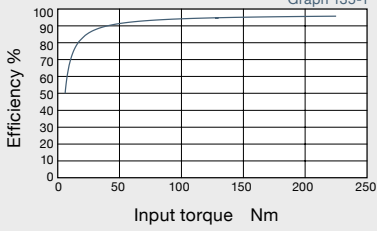

Reduction ratio = 4

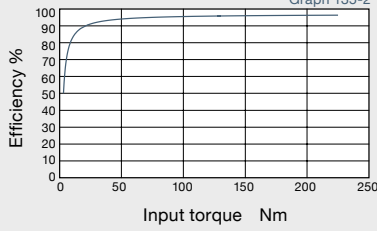

Reduction ratio = 5

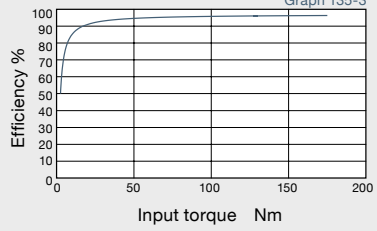

Reduction ratio = 7

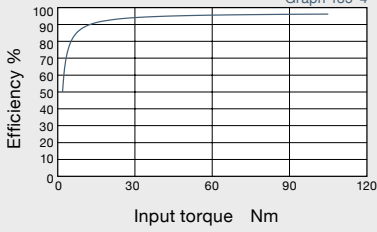

Reduction ratio = 10

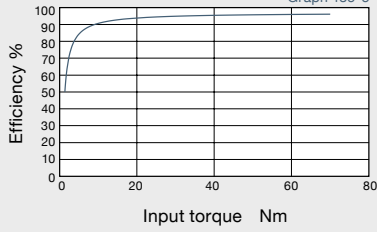

Reduction ratio = 13

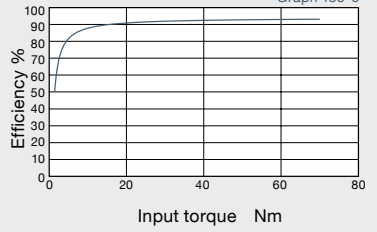

Reduction ratio = 21

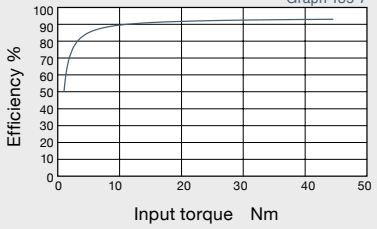

Reduction ratio = 31

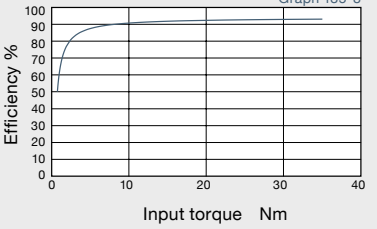

Size 25 : Hollow Shaft Unit

HPF

Reduction ratio = 11

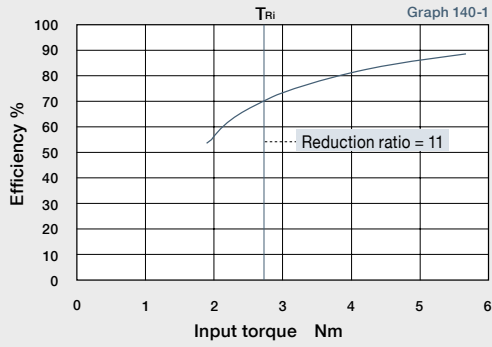

Size 32 : Hollow Shaft Unit

HPF

Reduction ratio = 11

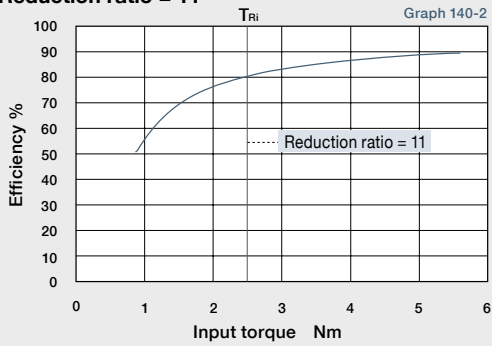

Size 14 : Gearhead

CSG-GH

CSF-GH

Reduction ratio = 50

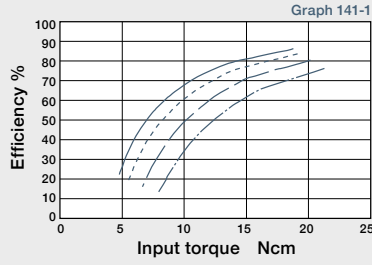

Reduction ratio = 80

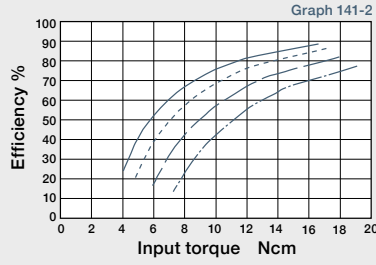

Reduction ratio = 100

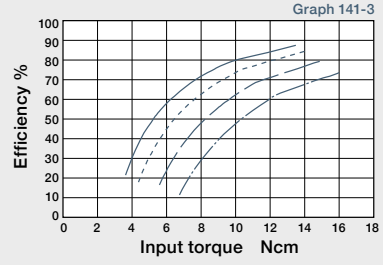

Input rotational speed — 500 rpm - - - - - 1000 rpm - · - · - 2000 rpm · · · · · 3500 rpm

Size 20 : Gearhead

CSG-GH

CSF-GH

Reduction ratio = 50

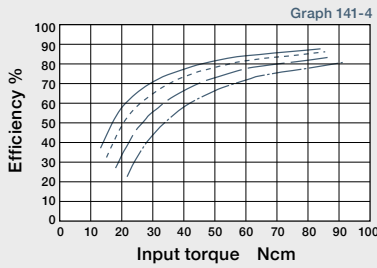

Reduction ratio = 80

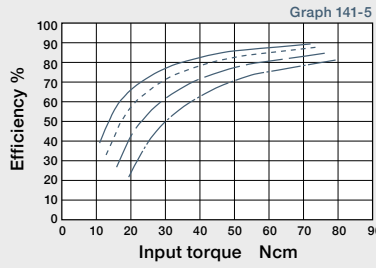

Reduction ratio = 100

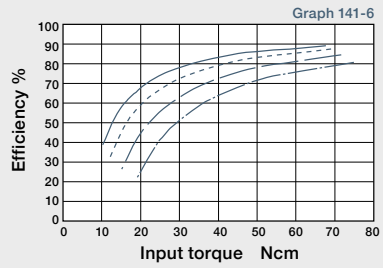

Reduction ratio = 120

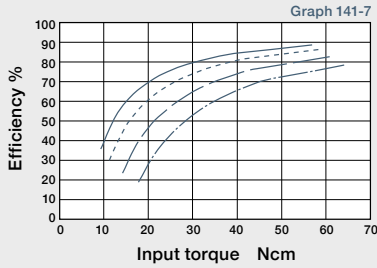

Reduction ratio = 160

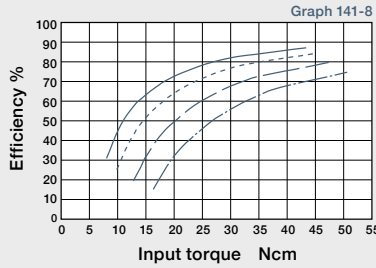

Input rotational speed — 500 rpm - - - - - 1000 rpm - · - · - 2000 rpm · · · · · 3500 rpm

Size 32 : Gearhead

CSG-GH

CSF-GH

Reduction ratio = 50

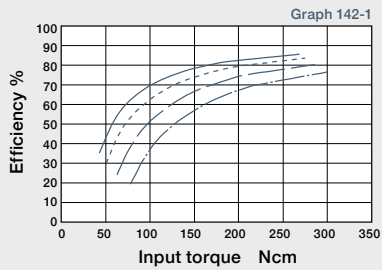

Reduction ratio = 80

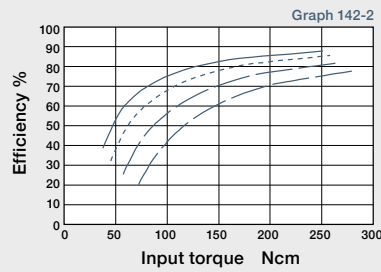

Reduction ratio = 100

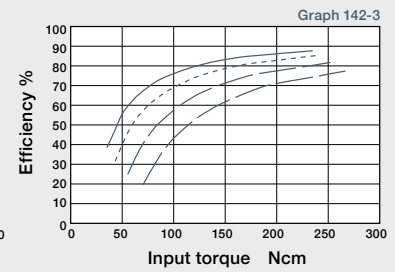

Reduction ratio = 120

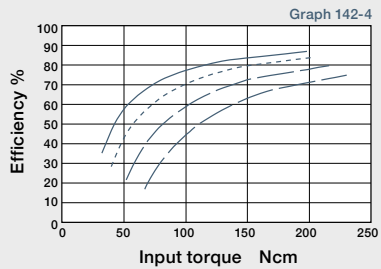

Reduction ratio = 160

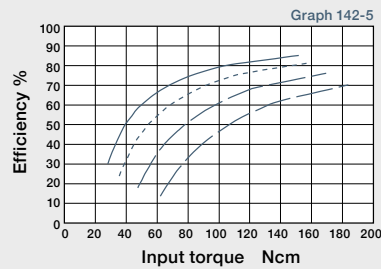

Input rotational speed — 500 rpm - - - - - 1000 rpm — 2000 rpm — 3500 rpm

Size 45 : Gearhead

CSG-GH

CSF-GH

Reduction ratio = 50

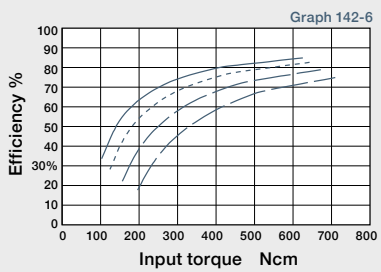

Reduction ratio = 80

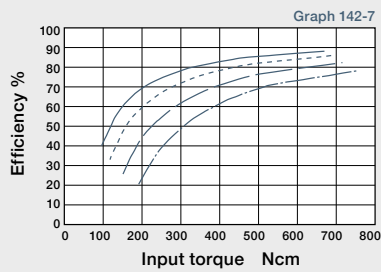

Reduction ratio = 100

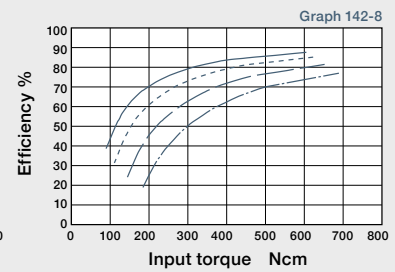

Reduction ratio = 120

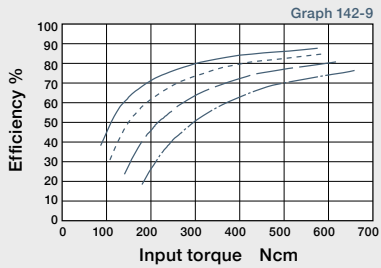

Reduction ratio = 160

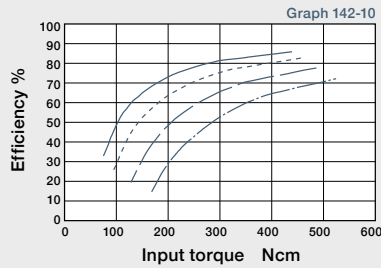

Input rotational speed — 500 rpm - - - - - 1000 rpm — 2000 rpm — 3500 rpm

Size 65

: Gearhead

CSG-GH

CSF-GH

Reduction ratio = 80

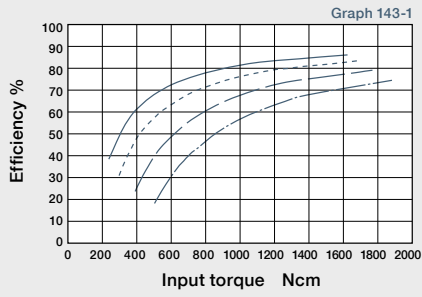

Reduction ratio = 100

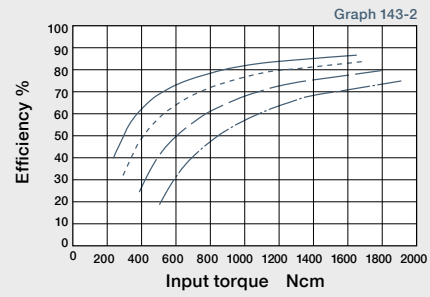

Reduction ratio = 120

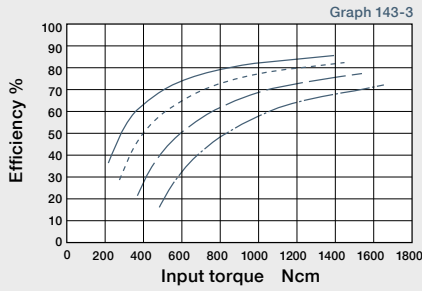

Reduction ratio = 160

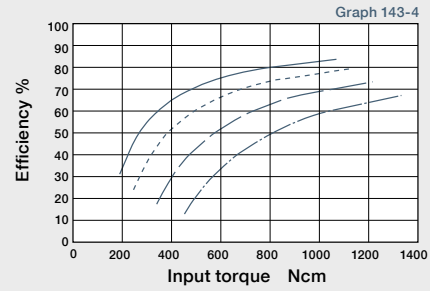

Input rotational speed — 500 rpm - - - - - 1000 rpm ——— 2000 rpm ——— 3500 rpm

Output Shaft Bearing Load Limits

HPN Series Output Shaft Load Limits are plotted below.

HPN uses deep groove ball bearings to support the output shaft. Please use the curve on the graph for the appropriate load coefficient (f_w) that represents the expected operating condition.

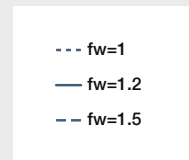
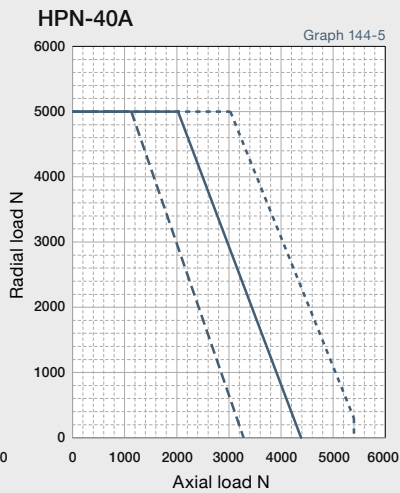
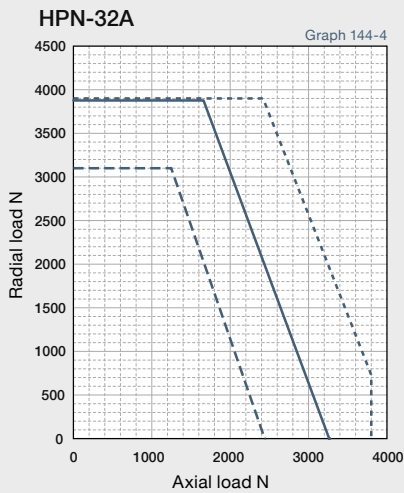
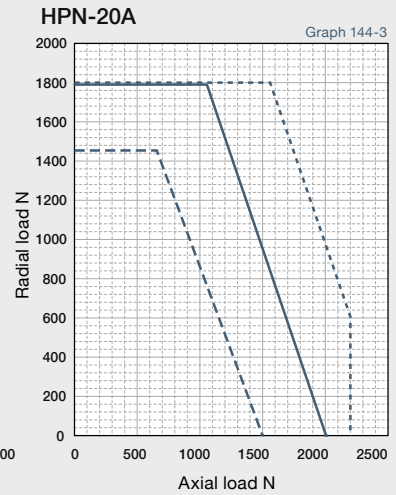
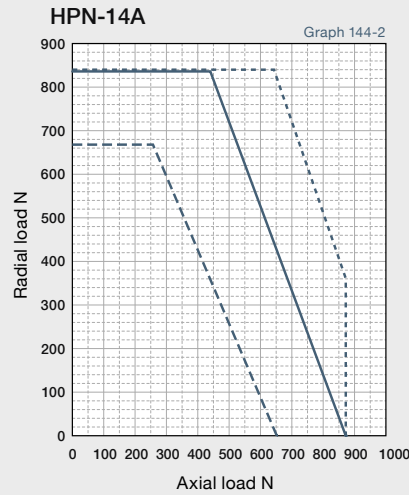
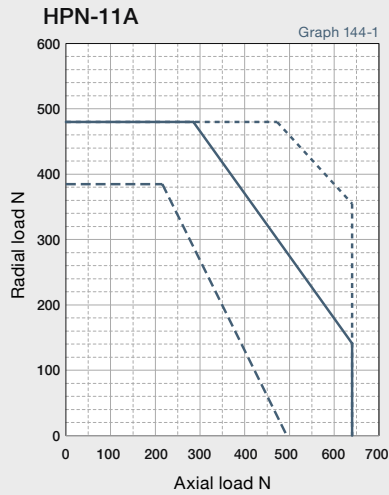

Load coefficient
 $f_w=1-1.2$ Smooth operation without impact
 $f_w=1.2-1.5$ Standard operation

Output shaft speed - 100 rpm, bearing life is based on 20,000 hours. The load-point is based on shaft center of radial load and axial load.

Output Bearing Specifications and Checking Procedure

HPGP, HPG, HPG Helical, CSF-GH, CSG-GH, HPF, and HPG-U1 are equipped with cross roller bearings. A precision cross roller bearing supports the external load (output flange). Check the maximum load, moment load, life of the bearing and static safety coefficient to maximize performance.

Checking procedure

(1) Checking the maximum moment load (M_{max})

Calculate the maximum moment load (M_{max}). ●●▶ Maximum moment load (M_{max}) ≤ Permissible moment (M_c)

(2) Checking the life

Calculate the average radial load (F_{rav}) and the average axial load (F_{aav}). ●●▶ Calculate the radial load coefficient (X) and the axial load coefficient (Y). ●●▶ Calculate the life and check it.

(3) Checking the static safety coefficient

Calculate the static equivalent radial load coefficient (P_o). ●●▶ Check the static safety coefficient. (f_s)

Specification of output bearing

HPGP/HPG Series Tables 145-1, -2 and -3 indicate the cross roller bearing specifications for in-line, right angle and input shaft gears.

Table 145-1

Size	Pitch circle	Offset amount	Basic rated load				Allowable moment load M_c^{*3}		Moment stiffness Km^{*4}	
	dp	R	Basic dynamic load rating C^{*1}		Basic static load rating Co^{*2}		Nm	Kgf·m	x10 ⁴ Nm/rad	Kgf·m/ arc min
	m	m	N	kgf	N	kgf				
11	0.0275	0.006	3116	318	4087	417	9.50	0.97	0.88	0.26
14	0.0405	0.011	5110	521	7060	720	32.3	3.30	3.0	0.90
20	0.064	0.0115	10600	1082	17300	1765	183	18.7	16.8	5.0
32	0.085	0.014	20500	2092	32800	3347	452	46.1	42.1	12.5
50	0.123	0.019	41600	4245	76000	7755	1076	110	100	29.7
65	0.170	0.023	90600	9245	148000	15102	3900	398	364	108

Table 145-2

Size	Reduction ratio	Allowable radial load ^{*5}	Allowable axial load ^{*5}
		N	N
11	5	280	430
	(9)	340	510
	21	440	660
	37	520	780
	45	550	830
14	(3)	400	600
	5	470	700
	11	600	890
	15	650	980
	21	720	1080
20	33	830	1240
	45	910	1360
	(3)	840	1250
	5	980	1460
	11	1240	1850
32	15	1360	2030
	21	1510	2250
	33	1729	2580
	45	1890	2830

* The ratio specified in parentheses is for the HPG Series.

Table 145-3

Size	Reduction ratio	Allowable radial load ^{*5}	Allowable axial load ^{*5}
		N	N
11	(3)	1630	2430
	5	1900	2830
	11	2410	3590
	15	2640	3940
	21	2920	4360
14	33	3340	4990
	45	3670	5480
	(3)	3700	5570
	5	4350	6490
	11	5500	8220
20	15	6050	9030
	21	6690	9980
	33	7660	11400
	45	8400	12500
	4	8860	13200
32	5	9470	14100
	12	12300	18300
	15	13100	19600
	20	14300	21400
	25	15300	22900
50	(40)	17600	26300
	(50)	18900	28200

* The ratio specified in parentheses is for the HPG Series.

[Note: Table 145-1, -2 and -3 Table 146-1 and -2]

*1 The basic dynamic load rating means a certain static radial load so that the basic dynamic rated life of the roller bearing is a million rotations.

*2 The basic static load rating means a static load that gives a certain level of contact stress (4kN/mm²) in the center of the contact area

CSG-GH/CSF-GH Series Table 146-1 indicates the specifications for cross roller bearing.

Table 146-1

Size	Pitch circle	Offset amount	Basic load rating				Allowable moment load Mc* ³		Moment stiffness Km* ⁴		Allowable radial load* ⁵	Allowable axial load* ⁵
	dp	R	Basic dynamic load rating C* ¹		Basic static load rating Co* ²		Nm	kgfm	×10 ⁴ Nm/rad	kgfm/ arc min	N	N
	m	m	N	kgf	N	kgf						
14	0.0405	0.011	5110	521	7060	720	27	2.76	3.0	0.89	732	1093
20	0.064	0.0115	10600	1082	17300	1765	145	14.8	17	5.0	1519	2267
32	0.085	0.014	20500	2092	32800	3347	258	26.3	42	12	2938	4385
45	0.123	0.019	41600	4245	76000	7755	797	81.3	100	30	5962	8899
65	0.170	0.0225	81600	8327	149000	15204	2156	220	323	96	11693	17454

HPF Series Table 146-2 indicates the specifications for cross roller bearing.

Table 146-2

Size	Pitch circle	Offset amount	Basic load rating				Allowable moment load Mc* ³		Moment stiffness Km* ⁴		Allowable radial load* ⁵	Allowable axial load* ⁵
	dp	R	Basic dynamic load rating C* ¹		Basic static load rating Co* ²		Nm	kgfm	×10 ⁴ Nm/rad	kgfm/ arc min	N	N
	m	m	N	kgf	N	kgf						
25	0.085	0.0153	11400	1163	20300	2071	410	41.8	37.9	11.3	1330	1990
32	0.1115	0.015	22500	2296	39900	4071	932	95	86.1	25.7	2640	3940

[Note: Table 145-1, -2 and -3 Table 146-1 and -2]

- *1 The basic dynamic load rating means a certain static radial load so that the basic dynamic rated life of the roller bearing is a million rotations.
- *2 The basic static load rating means a static load that gives a certain level of contact stress (4kN/mm²) in the center of the contact area between rolling element receiving the maximum load and orbit.
- *3 The allowable moment load is a maximum moment load applied to the bearing. Within the allowable range, basic performance is maintained and the bearing is operable. Check the bearing life based on the calculations shown on the next page.
- *4 The value of the moment stiffness is the average value.
- *5 The allowable radial load and allowable axial load are the values that satisfy the life of a speed reducer when a pure radial load or an axial load applies to the main bearing. (Lr + R = 0 mm for radial load and La = 0 mm for axial load) If a compound load applies, refer to the calculations shown on the next page.

How to calculate the maximum moment load

- HPGP
- HPG
- CSG-GH
- CSF-GH
- HPF

Maximum moment load (M_{max}) is obtained as follows.
Make sure that $M_{max} \leq M_c$.

Formula 147-1

$$M_{max} = Fr_{max}(L_r + R) + Fa_{max}La$$

Fr_{max}	Max. radial load	N (kgf)	See Fig. 147-1.
Fa_{max}	Max. axial load	N (kgf)	See Fig. 147-1.
L_r, La	—	m	See Fig. 147-1.
R	Offset amount	m	See Fig. 147-1. See "Output Bearing Specifications" of each series, p.145 & 146

Figure 147-1

External load influence diagram

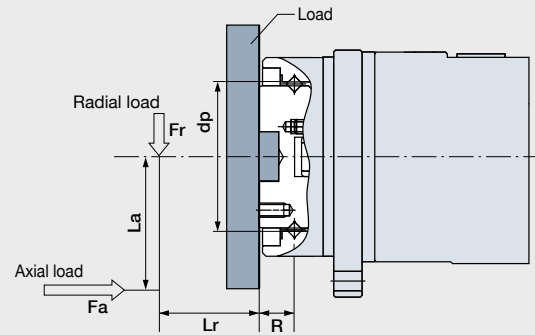

How to calculate the radial and the axial load coefficient

- HPGP
- HPG
- CSG-GH
- CSF-GH
- HPF

The radial load coefficient (X) and the axial load coefficient (Y)

Formula 147-2

Formula	X	Y
$\frac{Fa_{av}}{Fr_{av} + 2(Fr_{av}(L_r + R) + Fa_{av} \cdot La) / dp} \leq 1.5$	1	0.45
$\frac{Fa_{av}}{Fr_{av} + 2(Fr_{av}(L_r + R) + Fa_{av} \cdot La) / dp} > 1.5$	0.67	0.67

Fr_{av}	Average radial load	N (kgf)	See "How to calculate the average load below."
Fa_{av}	Average axial load	N (kgf)	See "How to calculate the average load below."
L_r, La	—	m	See Fig. 147-1.
R	Offset amount	m	See Fig. 147-1. See "Output Bearing Specifications" of each series, p. 145 & 146.
dp	Circular pitch of roller	m	See Fig. 147-1. See "Output Bearing Specifications" of each series, p. 145 & 146.

How to calculate the average load (Average radial load, average axial load, average output speed)

- HPGP
- HPG
- CSG-GH
- CSF-GH
- HPF

If the radial load and the axial load fluctuate, they should be converted into the average load to check the life of the cross roller bearing.

How to obtain the average radial load (Fr_{av}) Formula 147-3

$$Fr_{av} = \sqrt[10/3]{\frac{n_1 t_1 (|Fr_1|)^{10/3} + n_2 t_2 (|Fr_2|)^{10/3} + \dots + n_n t_n (|Fr_n|)^{10/3}}{n_1 t_1 + n_2 t_2 + \dots + n_n t_n}}$$

Note that the maximum radial load within the t_1 section is Fr_1 and the maximum radial load within the t_3 section is Fr_3 .

How to obtain the average axial load (Fa_{av}) Formula 147-4

$$Fa_{av} = \sqrt[10/3]{\frac{n_1 t_1 (|Fa_1|)^{10/3} + n_2 t_2 (|Fa_2|)^{10/3} + \dots + n_n t_n (|Fa_n|)^{10/3}}{n_1 t_1 + n_2 t_2 + \dots + n_n t_n}}$$

Note that the maximum axial load within the t_1 section is Fa_1 and the maximum axial load within the t_3 section is Fa_3 .

How to obtain the average output speed (N_{av}) Formula 147-5

$$N_{av} = \frac{n_1 t_1 + n_2 t_2 + \dots + n_n t_n}{t_1 + t_2 + \dots + t_n}$$

How to calculate the life HPGP HPG CSG-GH CSF-GH HPF

Calculate the life of the cross roller bearing using Formula 148-1. You can obtain the dynamic equivalent load (P_c) using Formula 148-2.

Formula 148-1

$$L_{10} = \frac{10^6}{60 \times N_{av}} \times \left(\frac{C}{f_w \cdot P_c} \right)^{10/3}$$

L₁₀	Life	hour	—
N_{av}	Ave. output speed	rpm	See "How to calculate the ave. load."
C	Basic dynamic load rating	N (kgf)	See "Output Bearing Specs."
P_c	Dynamic equivalent load	N (kgf)	See Formula 148-2.
f_w	Load coefficient	—	See Table 148-1.

Formula 148-2

$$P_c = X \cdot \left(Fr_{av} + \frac{2(Fr_{av}(L_r + R) + Fa_{av} \cdot La)}{dp} \right) + Y \cdot Fa_{av}$$

Fr_{av}	Average radial load	N (kgf)	See "How to calculate the ave. load."
Fa_{av}	Average axial load	N (kgf)	
dp	Pitch Circle of roller	m	See "Output Bearing Specs."
X	Radial load coefficient	—	See "How to calculate the radial load coefficient and the axial load coefficient."
Y	Axial load coefficient	—	
L_r, La	—	m	See Figure 147-1. See "External load influence diagram."
R	Offset amount	m	See Figure 147-1. See "External load influence diagram" and "Output Bearing Specs" of each series.

Load coefficient Table 148-1

Load status	f _w
During smooth operation without impact or vibration	1 to 1.2
During normal operation	1.2 to 1.5
During operation with impact or vibration	1.5 to 3

How to calculate the life during oscillating motion HPGP HPG CSG-GH CSF-GH HPF

Calculate the life of the cross roller bearing during oscillating motion by Formula 144-3.

Formula 148-3

$$L_{oc} = \frac{10^6}{60 \times n_1} \times \frac{90}{\theta} \times \left(\frac{C}{f_w \cdot P_c} \right)^{10/3}$$

L_{oc}	Rated life under oscillating motion	hour	—
n₁	No. of reciprocating oscillation per min.	cpm	—
C	Basic dynamic load rating	N (kgf)	See "Output Bearing Specs."
P_c	Dynamic equivalent load	N (kgf)	See Formula 148-2.
f_w	Load coefficient	—	See Table 148-1.
θ	Oscillating angle /2	Deg.	See Figure 148-1.

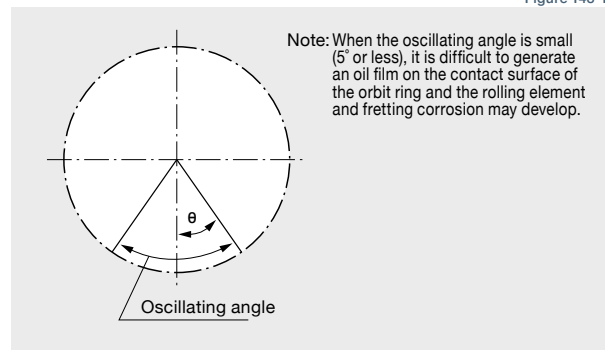

Note When it is used for a long time while the rotation speed of the output shaft is in the ultra-low operation range (0.02rpm or less), the lubrication of the bearing becomes insufficient, resulting in deterioration of the bearing or increased load in the output side. When using it in the ultra-low operation range, contact us.

How to calculate the static safety coefficient HPGP HPG CSG-GH CSF-GH HPF

In general, the basic static load rating (C_0) is considered to be the permissible limit of the static equivalent load. However, obtain the limit based on the operating and required conditions. Calculate the static safety coefficient (f_s) of the cross roller bearing using Formula 148-4.

General values under the operating condition are shown in Table 148-2. You can calculate the static equivalent load (P_0) using Formula 148-5.

Formula 148-4

$$f_s = \frac{C_0}{P_0}$$

C₀	Basic static load	N (kgf)	See "Output Bearing Specs."
P₀	Static equivalent load	N (kgf)	See Formula 148-5.

Formula 148-5

$$P_0 = Fr_{max} + \frac{2M_{max}}{dp} + 0.44Fa_{max}$$

Fr_{max}	Max. radial load	N (kgf)	
Fa_{max}	Max. axial load	N (kgf)	See "How to calculate the max. moment load."
M_{max}	Max. moment load	Nm (kgfm)	
dp	Pitch Circle	m	See "Output Bearing Specs" of each series.

Static safety coefficient Table 148-2

Load status	f _s
When high precision is required	≥ 3
When impact or vibration is expected	≥ 2
Under normal operating condition	≥ 1.5

Input Bearing Specifications and Checking Procedure

Check the maximum load and life of the bearing on the input side if the reducer is an HPG input shaft unit or an HPF hollow shaft unit.

Checking procedure

HPG

HPF

(1) Checking maximum load

Calculate:

Maximum moment load ($Mi\ max$)
Maximum axial load ($Fai\ max$)
Maximum radial load ($Fri\ max$)



Maximum moment load ($Mi\ max$) \leq Allowable moment load (Mc)
Maximum axial load ($Fai\ max$) \leq Allowable axial load (Fac)
Maximum radial load ($Fri\ max$) \leq Allowable radial load (Frc)

(2) Checking the life

Calculate:

Average moment load ($Mi\ av$)
Average axial load ($Fai\ av$)
Average input speed ($Ni\ av$)



Calculate the life and check it.

Specification of input bearing

Specification of input bearing

HPG

Table 149-1

Size	Basic load rating			
	Basic dynamic load rating Cr		Basic static load rating Cor	
	N	kgf	N	kgf
11	2700	275	1270	129
14	5800	590	3150	320
20	9700	990	5600	570
32	22500	2300	14800	1510
50	35500	3600	25100	2560
65	51000	5200	39500	4050

Table 149-2

Size	Allowable moment load Mc		Allowable axial load Fac^{*1}		Allowable radial load Frc^{*2}	
	Nm	kgfm	N	kgf	N	kgf
11	0.16	0.016	245	25	20.6	2.1
14	6.3	0.64	657	67	500	51
20	13.5	1.38	1206	123	902	92
32	44.4	4.53	3285	335	1970	201
50	96.9	9.88	5540	565	3226	329
65	210	21.4	8600	878	5267	537

Specification of input shaft bearing

HPF

Table 149-3

Size	Basic load rating			
	Basic dynamic load rating Cr		Basic static load rating Cor	
	N	kgf	N	kgf
25	14500	1480	10100	1030
32	29700	3030	20100	2050

Table 149-4

Size	Allowable moment load Mc		Allowable axial load Fac^{*1}		Allowable radial load Frc^{*3}	
	Nm	kgfm	N	kgf	N	kgf
25	10	1.02	1538	157	522	53.2
32	19	1.93	3263	333	966	98.5

[Note: Table 149-2 and 149-4]

*1 The allowable axial load is the value of an axial load applied along the axis of rotation.

*2 The allowable radial load of HPG series is the value of a radial load applied at the mid-point of the input shaft.

*3 The allowable radial load of HPG series is the value of a radial load applied to the point of 20 mm from the shaft edge (input flange edge).

Calculating maximum moment load ON input shaft

The maximum moment load ($M_{i max}$) is calculated as follows.
Check that the following formulas are established in all circumstances:

Formula 150-1

$$M_{i max} = F_{ri max} \cdot L_{ri} + F_{ai max} \cdot L_{ai}$$

$F_{ri max}$	Max. radial load	N (kgf)	See Fig. 150-1.
$F_{ai max}$	Max. axial load	N (kgf)	See Fig. 150-1.
L_{ri}, L_{ai}	-----	m	See Fig. 150-1.

$$M_{i max} \leq M_c \text{ (Allowable moment load)}$$

$$F_{ai max} \leq F_{ac} \text{ (Allowable axial load)}$$

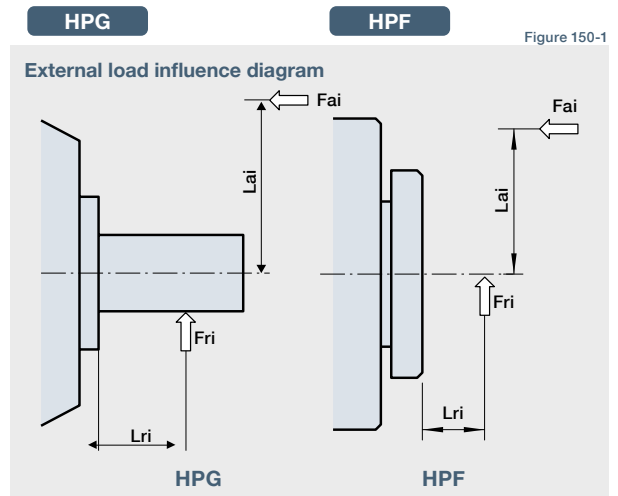

How to calculate average load (Average moment load, average axial load, average input speed)

If moment load and axial load fluctuate, they should be converted into the average load to check the life of the bearing.

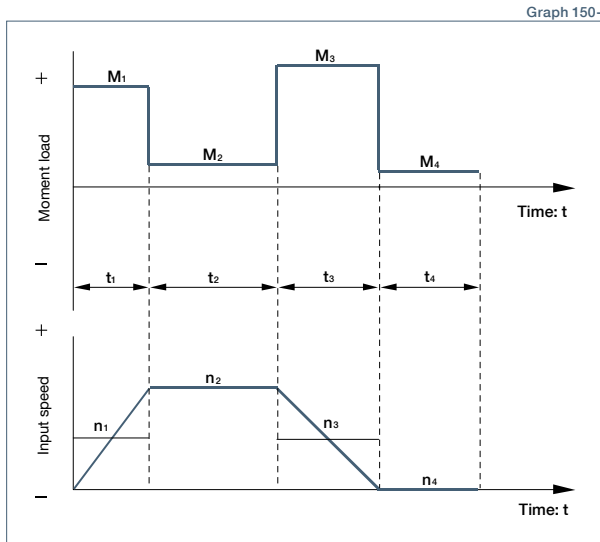

Formula 150-2

How to calculate the average moment load ($M_{i av}$)

$$M_{i av} = \sqrt[3]{\frac{n_1 t_1 (|M_{i1}|)^3 + n_2 t_2 (|M_{i2}|)^3 + \dots + n_n t_n (|M_{in}|)^3}{n_1 t_1 + n_2 t_2 + \dots + n_n t_n}}$$

Formula 150-3

How to calculate the average axial load ($F_{ai av}$)

$$F_{ai av} = \sqrt[3]{\frac{n_1 t_1 (|F_{ai1}|)^3 + n_2 t_2 (|F_{ai2}|)^3 + \dots + n_n t_n (|F_{ain}|)^3}{n_1 t_1 + n_2 t_2 + \dots + n_n t_n}}$$

Formula 150-4

How to calculate the average input speed ($N_{i av}$)

$$N_{i av} = \frac{n_1 t_1 + n_2 t_2 + \dots + n_n t_n}{t_1 + t_2 + \dots + t_n}$$

Calculating life of input bearing

Calculate the bearing life according to Calculation Formula 132-5 and check the life.

Formula 150-5

$$L_{10} = \frac{10^6}{60 \times N_{i av}} \times \left(\frac{C_r}{P_{ci}} \right)^3$$

L_{10}	Life	Hour	—
$N_{i av}$	Average input speed	rpm	See Formula 150-4
C_r	Basic dynamic load rating	N (kgf)	See Table 149-1 and -3
P_{ci}	Dynamic equivalent load	N	See Table 150-1 and -2

Table 150-1

Dynamic equivalent load		HPG
Size	P_{ci}	
11	$0.444 \times M_{i av} + 1.426 \times F_{ai av}$	
14	$0.137 \times M_{i av} + 1.232 \times F_{ai av}$	
20	$0.109 \times M_{i av} + 1.232 \times F_{ai av}$	
32	$0.071 \times M_{i av} + 1.232 \times F_{ai av}$	
50	$0.053 \times M_{i av} + 1.232 \times F_{ai av}$	
65	$0.041 \times M_{i av} + 1.232 \times F_{ai av}$	

Table 150-2

Dynamic equivalent load		HPF
Size	P_{ci}	
25	$121 \times M_{i av} + 2.7 \times F_{ai av}$	
32	$106 \times M_{i av} + 2.7 \times F_{ai av}$	

$M_{i av}$ Average moment load Nm (kgfm) See Formula 150-2
 $F_{ai av}$ Average axial load N (kgf) See Formula 150-3

Assembly

Assemble and mount your gearhead in accordance with these instructions to achieve the best performance. Be sure to use the recommended bolts and use a torque wrench to achieve the proper tightening torques as recommended in tables below.

Motor assembly procedure

HPGP
HPG
CSG-GH
CSF-GH
HPN

To properly mount the motor to the gearhead, follow the procedure outlined below, refer to figure 151-1

- (1) Turn the input shaft coupling and align the bolt head with the rubber cap hole.
- ↓
- (2) With the speed reducer in an upright position as illustrated in the figure below, slowly insert the motor shaft into the coupling of speed reducer. Slide the motor shaft without letting it drop down. If the speed reducer cannot be positioned upright, slowly insert the motor shaft into the coupling of speed reducer, then tighten the motor bolts evenly until the motor flange and gearhead flange are in full contact. Exercise care to avoid tilting the motor when inserting it into the gear head.

- (3) Tighten the input shaft coupling bolt to the recommended torque specified in the table below. The bolt(s) or screw(s) is (are) already inserted into the input coupling when delivered. Check the bolt size on the confirmation drawing provided.

Bolt tightening torque

Table 151-1

Bolt size	M3	M4	M5	M6	M8	M10	M12	
Tightening torque	Nm	2.0	4.5	9.0	15.3	37.2	73.5	128
	kgfm	0.20	0.46	0.92	1.56	3.8	7.5	13.1

Caution: Always tighten the bolts to the tightening torque specified in the table above. If the bolt is not tightened to the torque value recommended slippage of the motor shaft in the shaft coupling may occur. The bolt size will vary depending on the size of the gear and the shaft diameter of the mounted motor. Check the bolt size on the confirmation drawing provided.

Two setscrews need to be tightened on size 11. See the outline dimensions on page 22 (HPGP) and page 34 (HPG standard) and page 46 (HPG helical). Tighten the screws to the tightening torque specified below.

Table 151-2

Bolt size	M3	
Tightening torque	Nm	0.69
	kgfm	0.07

- (4) Fasten the motor to the gearhead flange with bolts.

Bolt* tightening torque

Table 151-3

Bolt size	M2.5	M3	M4	M5	M6	M8	M10	M12	
Tightening torque	Nm	0.59	1.4	3.2	6.3	10.7	26.1	51.5	89.9
	kgfm	0.06	0.14	0.32	0.64	1.09	2.66	5.25	9.17

* Recommended bolt: JIS B 1176 Hexagon socket head bolt, Strength: JIS B 1051 12.9 or higher

Caution: Be sure to tighten the bolts to the tightening torques specified in the table.

- (5) Insert the rubber cap provided. This completes the assembly. (Size 11: Fasten screws with a gasket in two places)

Figure 151-1

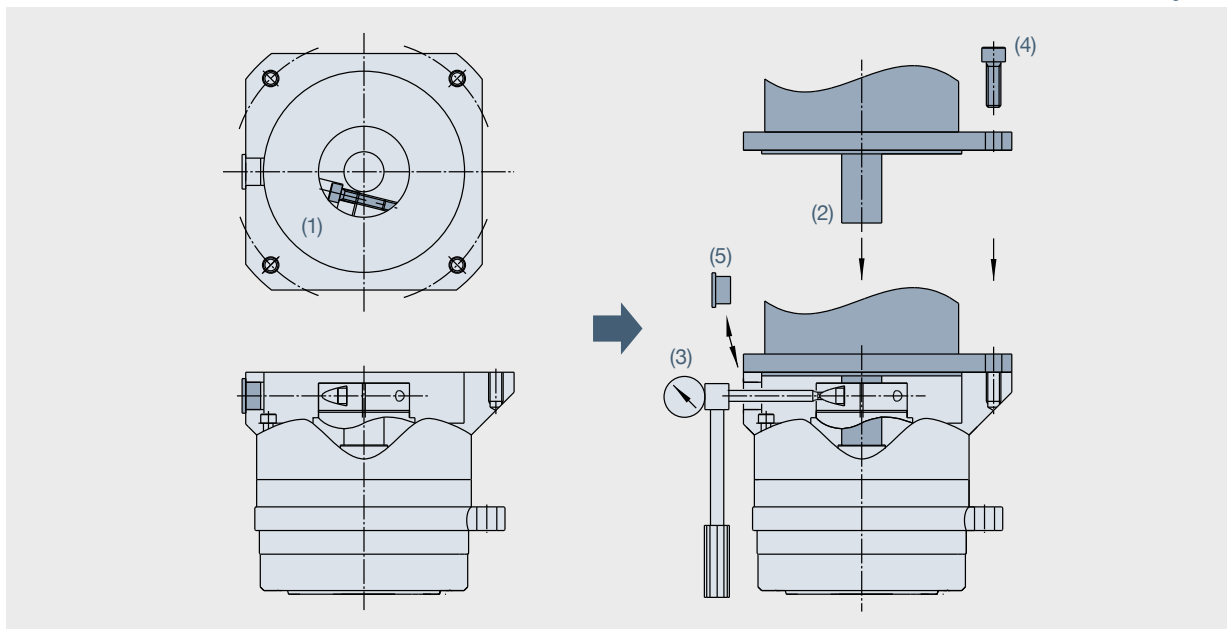

Speed reducer assembly

HPGP
HPG
CSG-GH
CSF-GH
HPF
HPN

Some right angle gearhead models weigh as much as 60 kg. No thread for an eyebolt is provided because the mounting orientation varies depending on the customer's needs. When mounting the reducer, hoist it using a sling paying extreme attention to safety.

When assembling gearheads into your equipment, check the flatness of your mounting surface and look for any burrs on tapped holes. Then fasten the flange (Part A in the diagram below) using appropriate bolts.

Bolt* tightening torque for flange (Part A in the diagram below)

Table 152-1

Size	HPN					HPGP / HPG / CSG-GH / CSF-GH						HPF		
	11	14	20	32	40	11	14	20	32	45/50	65	25	32	
Number of bolts	4	4	4	4	4	4	4	4	4	4	4	12	12	
Bolt size	M3	M5	M6	M8	M10	M3	M5	M8	M10	M12	M16	M4	M5	
Mounting PCD	mm	50	70	100	130	165	46	70	105	135	190	260	127	157
Tightening torque	Nm	1.4	6.3	10.7	26.1	51.5	1.4	6.3	26.1	51.5	103	255	4.5	9.0
	kgfm	0.14	0.64	1.09	2.66	5.26	0.14	0.64	2.66	5.25	10.5	26.0	0.46	0.92
Transmission torque	Nm	27.9	110	223	528	1063	26.3	110	428	868	2030	5180	531	1060
	kgfm	2.85	11.3	22.8	53.9	108.5	2.69	11.3	43.6	88.6	207	528	54.2	108

* Recommended bolts: JIS B 1176 "Hexagon socket head bolts." Strength classification 12.9 or higher in JIS B 1051.

Mounting the load to the output flange

Follow the specifications in the table below when mounting the load onto the output flange.

Figure 152-1

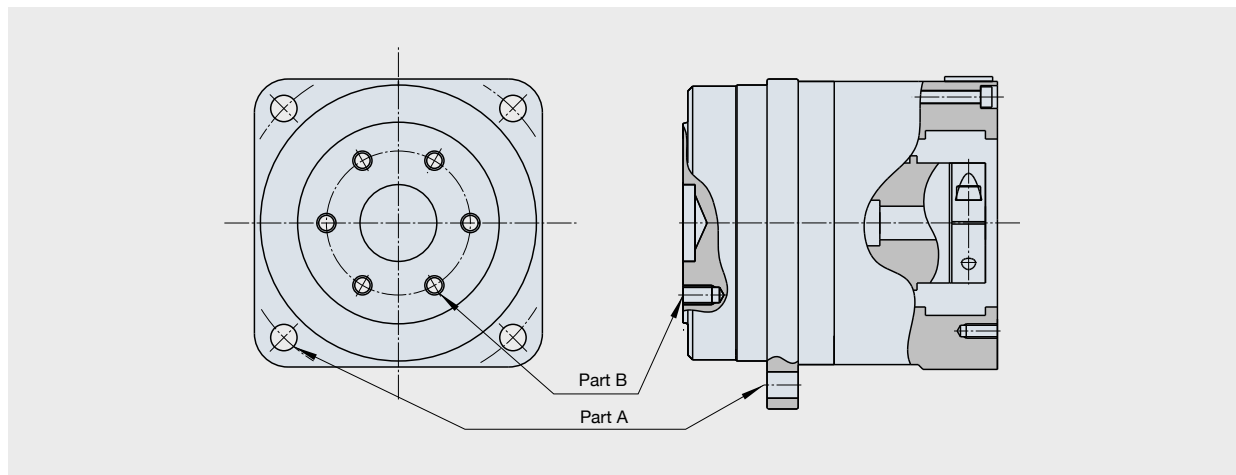

Output flange mounting specifications

Bolt* tightening torque for output flange (Part B in the Figure 152-1)

HPGP

Table 152-2

Size	11	14	20	32	50	65	
Number of bolts	4	8	8	8	8	8	
Bolt size	M4	M4	M6	M8	M12	M16	
Mounting PCD	mm	18	30	45	60	90	120
Tightening torque	Nm	4.5	4.5	15.3	37.2	128.4	319
	kgfm	0.46	0.46	1.56	3.8	13.1	32.5
Transmission torque	Nm	25.3	84	286	697	2407	5972
	kgfm	2.58	8.6	29.2	71.2	245	609

* Recommended bolts: JIS B 1176 "Hexagon socket head bolts." Strength classification 12.9 or higher in JIS B 1051.

Bolt* tightening torque for output flange (Part B in the Figure 152-1)

HPG

Table 152-3

Size	11	14	20	32	50	65	
Number of bolts	3	6	6	6	14	6	
Bolt size	M4	M4	M6	M8	M8	M16	
Mounting PCD	mm	18	30	45	60	100	120
Tightening torque	Nm	4.5	4.5	15.3	37.2	37.2	319
	kgfm	0.46	0.46	1.56	3.8	3.80	32.5
Transmission torque	Nm	19.0	63	215	524	2036	4480
	kgfm	1.9	6.5	21.9	53.4	207.8	457

* Recommended bolts: JIS B 1176 "Hexagon socket head bolts." Strength classification 12.9 or higher in JIS B 1051.

Mounting the load to the output flange

Bolt* tightening torque for output flange (Part B in Figure 152-1)

CSG-GH

Table 153-1

Size		14	20	32	45	65
Number of bolts		8	8	10	10	10
Bolt size		M4	M6	M8	M12	M16
Mounting PCD	mm	30	45	60	94	120
	Nm	4.5	15.3	37	128	319
Tightening torque	kgfm	0.46	1.56	3.8	3.1	32.5
	Nm	84	287	867	3067	7477
Transmission torque	kgfm	8.6	29.3	88.5	313	763

Bolt* tightening torque for output flange (Part B in Figure 152-1)

CSF-GH

Table 153-2

Size		14	20	32	45	65
Number of bolts		6	6	6	16	8
Bolt size		M4	M6	M8	M8	M16
Mounting PCD	mm	30	45	60	100	120
	Nm	4.5	15.3	37.2	37.2	319
Tightening torque	kgfm	0.46	1.56	3.80	3.80	32.5
	Nm	63	215	524	2326	5981
Transmission torque	kgfm	6.5	21.9	53.4	237	610

Bolt* tightening torque for output flange
(Part B in Figure 152-1)

HPF

Table 153-3

Size		25	32
Number of bolts		12	12
Bolt size		M4	M5
Mounting PCD	mm	77	100
	Nm	4.5	9.0
Tightening torque	kgfm	0.46	0.92
	Nm	322	675
Transmission torque	kgfm	32.9	68.9

* Recommended bolts: JIS B 1176 "Hexagon socket head bolts." Strength classification 12.9 or higher in JIS B 1051.

Gearheads with an output shaft

HPN

HPG

HPGP

CSG-GH

CSF-GH

HPF

Do not subject the output shaft to any impact when mounting a pulley, pinion or other parts.

An impact to the the output bearing may affect the speed reducer precision and may cause reduced life or failure.

Mechanical Tolerances

Superior mechanical precision is achieved by integrating the output flange with a high-precision cross roller bearing as a single component. The mechanical tolerances of the output shaft and mounting flange are specified below.

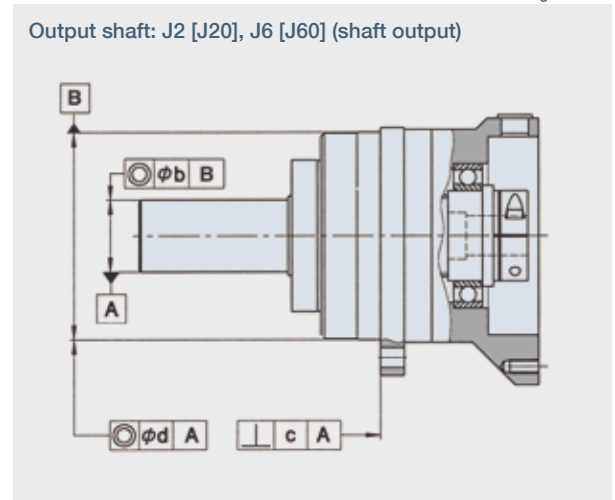
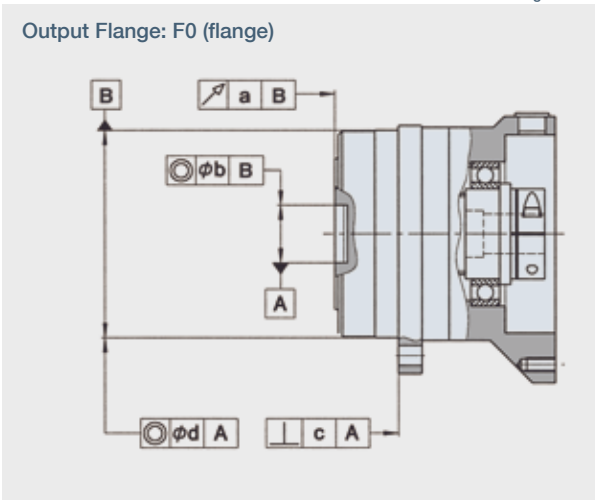

HPGP		HPG		CSG-GH		CSF-GH		
Size	Axial runout of output flange a	Radial runout of output flange pilot or output shaft b	Perpendicularity of mounting flange c	Concentricity of mounting flange d	Table 154-1			
11	0.020	0.030	0.050	0.040				
14	0.020	0.040	0.060	0.050				
20	0.020	0.040	0.060	0.050				
32	0.020	0.040	0.060	0.050				

HPGP		HPG		Table 154-2				
50	0.020	0.040	0.060	0.050				
65	0.040	0.060	0.090	0.080				

CSG-GH		CSF-GH		Table 154-3				
45	0.020	0.040	0.060	0.050				
65	0.020	0.040	0.060	0.050				

HPF		Table 154-4						
25	0.020	0.040	0.060	0.050				
32	0.020	0.040	0.060	0.050				

* T.I.R.: Total indicator reading

(T.I.R.* Unit: mm)

Lubrication

Prevention of grease and oil leakage

(Common to all models)

- Only use the recommended greases.
- Provisions for proper sealing to prevent grease leakage are incorporated into the gearheads. However, please note that some leakage may occur depending on the application or operating condition. Discuss other sealing options with our applications engineers.
- When mounting the gearhead horizontally, position the gearhead so that the rubber cap in the adapter flange is facing upwards.

(CSG/CSF-GH Series)

- Contact us when using HarmonicDrive® CSG/CSF-GH series with the output shaft facing downward (motor on top) at a constant load or rotating continuously in one direction.

Sealing

(Common to all models)

- Provisions for proper sealing to prevent grease leakage from the input shaft are incorporated into the gearhead.
- A double lip Teflon oil seal is used for the output shaft (HPGP/HPG uses a single lip seal), gaskets or o-rings are used on all mating surfaces, and non contact shielded bearings are used for the motor shaft coupling (Double sealed bearings (D type) are available as an option*). On the CSG/CSF-GH series, non contact shielded bearing and a Teflon oil seal with a spring is used.
- Material and surface: Gearbox: Aluminum, corrosion protected roller bearing steel, carbon steel (output shaft). Adapter flange: (if provided by Harmonic Drive) high-strength aluminum or carbon steel. Screws: black phosphate. The ambient environment should not subject any corrosive agents to the above mentioned material. The product provides protection class IP 54 under the provision that corrosion from the ambient atmosphere (condensation, liquids or gases) at the running surface of the output shaft seal is prevented. If necessary, the adapter flange can be sealed by means of a surface seal (e.g. Loctite 515).

* D type: Bearing with a rubber contact seal on both sides

(HPG/HPGP/HPF/HPN Series)

- Using the double sealed bearing (D type) for the HPGP/HPG series gearhead will result in a slightly lower efficiency compared to the standard product.
- An oil seal without a spring is used ON the input side of HPG series with an input shaft (HPG-1U) and HPF series hollow shaft reducer. An option for an oil seal with a spring is available for improved seal reliability, however, the efficiency will be slightly lower (available for HPF and HPG series for sizes 14 and larger).
- Do not remove the screw plug and seal cap of the HPG series right angle gearhead. Removing them may cause leakage of grease or affect the precision of the gear.

Standard Lubricants

HPG/HPGP/HPF/HPN Series

The standard lubrication for the HPG/HPGP/HPF/HPN series gearheads is grease.

All gearheads are lubricated at the factory prior to shipment and additional application of grease during assembly is not required.

The gearheads are lubricated for the life of the gear and do not require re-lubrication.

High efficiency is achieved through the unique planetary gear design and grease selection.

Lubricants

Harmonic Grease SK-2 (HPGP/HPG-14, 20, 32)
Manufacturer: Harmonic Drive Systems Inc.

Base oil: Refined mineral oil	Consistency: 265 to 295 at 25°C
Thickening agent: Lithium soap	Dropping point: 198°C
Additive: Extreme pressure agent and other	Color: Green
Standard: NLGI No. 2	

EPNOC Grease AP (N) 2 (HPGP/HPG-11, 50, 65/HPF-25, 32)
Manufacturer: Nippon Oil Co.

Base oil: Refined mineral oil	Consistency: 282 at 25°C
Thickening agent: Lithium soap	Dropping point: 200°C
Additive: Extreme pressure agent and other	Color: Light brown
Standard: NLGI No. 2	

PYRONOC UNIVERSAL 00 (HPG right angle gearhead/HPN)
Manufacturer: Nippon Oil Co.

Base oil: Refined mineral oil	Consistency: 420 at 25°C
Thickening agent: Urea	Dropping point: 250°C or higher
Standard: NLGI No. 00	Color: Light yellow

MULTEMP AC-P (HPG-X-R)
Manufacturer: KYODO YUSHI CO, LTD

Base oil: Composite hydrocarbon oil and diester	Standard: NLGI No. 2
Thickening agent: Lithium soap	Consistency: 280 at 25°C
Additive: Extreme pressure and others	Dropping point: 200°C
	Color: Black viscose

Ambient operating temperature range: -10°C to +40°C

The lubricant may deteriorate if the ambient operating temperature is outside of recommended operating range. Please contact our sales office or distributor for operation outside of the ambient operating temperature range.

The temperature rise of the gear depends upon the operating cycle, ambient temperature and heat conduction and radiation based on the customers installation of the gear. A housing surface temperature of 70°C is the maximum allowable limit.

CSG-GH/CSF-GH Series

The standard lubrication for the CGS-GH / CSF-GH series gearheads is grease. All gearheads are lubricated at the factory prior to shipment and additional application of grease during assembly is not necessary.

Lubricants

Harmonic Grease SK-1A (Size 20, 32, 45, 65)
Manufacturer: Harmonic Drive Systems Inc.

This grease has been developed exclusively for HarmonicDrive® gears and is excellent in durability and efficiency compared to commercial general-purpose grease.

Base oil: Refined mineral oil
Thickening Agent: Lithium soap
Additive: Extreme pressure agent and other
Standard: NLGI No. 2
Consistency: 265 to 295 at 25°C
Dropping point: 197°C
Color: Yellow

Harmonic Grease SK-2 (Size 14)
Manufacturer: Harmonic Drive Systems Inc.

This grease has been developed exclusively for smaller sized HarmonicDrive® gears and allows smooth wave generator rotation.

Base oil: Refined mineral oil
Thickening Agent: Lithium soap
Additive: Extreme pressure agent and other
Standard: NLGI No. 2
Consistency: 265 to 295 at 25°C
Dropping point: 198°C
Color: Green

Ambient operating temperature range: -10°C to +40°C

The lubricant may deteriorate if the ambient operating temperature is outside the recommended temperature range. Please contact our sales office or distributor for operation outside of the ambient operating temperature range.

The temperature rise of the gear depends upon the operating cycle, ambient temperature and heat conduction and radiation based on the customers installation of the gear. A housing surface temperature of 70°C is the maximum allowable limit.

When to change the grease

The life of the Harmonic Drive® gear is affected by the grease performance. The grease performance varies with temperature and deteriorates at elevated temperatures. Therefore, the grease will need to be changed sooner than usual when operating at higher temperatures. The graph on the right indicates when to change the grease based upon the temperature (when the average load torque is less than or equal to the rated output torque at 2000 rpm). Also, using the formula below, you can calculate when to change the grease when the average load torque exceeds the rated output torque (at 2000 rpm).

Formula to calculate the grease change interval when the average load torque exceeds the rated torque Formula 156-1

$$L_{GT} = L_{GTn} \times \left(\frac{T_r}{T_{av}} \right)^3$$

Formula symbols

Table 156-1

L_{GT}	Grease change interval when $T_{av} > T_r$	Input rotations	_____
L_{GTn}	Grease change interval when $T_{av} \leq T_r$	Input rotations	See Graph 156-1
T_r	Output torque at 2000 rpm	Nm, kgfm	See the "Rating table" on pages 79 & 89.
T_{av}	Average load torque	Nm, kgfm	Calculation formula: See page 104.

When to change the grease:
LGTn (when the average load torque is equal to or less than the rated output torque at 2000 rpm)

Figure 156-1

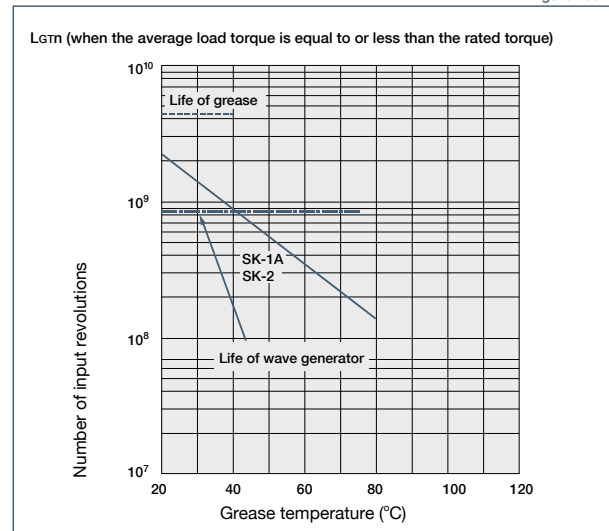

* L10 Life of wave generator bearing

Reference values for grease refill amount

Table 156-2

Size	14	20	32	45	65
Amount: g	0.8	3.2	6.6	11.6	78.6

Precautions when changing the grease

Strictly observe the following instructions when changing the grease to avoid problems such as grease leakage or increase in running torque.

- Note that the amount of grease listed in Table 156-2 is the amount used to lubricate the gear at assembly. This should be used as a reference. Do not exceed this amount when re-greasing the gearhead.
- Remove grease from the gearhead and refill it with the same quantity. The adverse effects listed above normally do not occur until the gear has been re-greased 2 times. When re-greasing 3 times or more, it is essential to remove grease (using air pressure or other means) before re-lubricating with the same amount of grease that was removed.

Warranty

Please contact us or visit our website at www.harmonicdrive.net for warranty details for your specific product.

All efforts have been made to ensure that the information in this catalog is complete and accurate. However, Harmonic Drive LLC is not liable for any errors, omissions or inaccuracies in the reported data. Harmonic Drive LLC reserves the right to change the product specifications, for any reason, without prior notice. For complete details please refer to our current Terms and Conditions posted on our website.

Disposal

When disposing of the product, disassemble it and sort the component parts by material type and dispose of the parts as industrial waste in accordance with the applicable laws and regulations. The component part materials can be classified into three categories.

- (1) Rubber parts: Oil seals, seal packings, rubber caps, seals of shielded bearings on input side (D type only)
- (2) Aluminum parts: Housings, motor flanges
- (3) Steel parts: Other parts

Trademark

HarmonicDrive® is a registered trademark of Harmonic Drive LLC.

HarmonicPlanetary® is a registered trademark of Harmonic Drive LLC.

Safety

 **Warning** : Means that improper use or handling could result in a risk of death or serious injury.

 **Caution** : Means that improper use or handling could result in personal injury or damage to property.





Application Restrictions









This product cannot be used for the following applications:





- * Space flight hardware
- * Aircraft equipment
- * Nuclear power equipment
- * Equipment and apparatus used in residential dwellings
- * Vacuum environments
- * Automotive equipment
- * Personal recreation equipment
- * Equipment that directly works on human bodies
- * Equipment for transport of humans
- * Equipment for use in a special environment
- * Medical equipment

Please consult Harmonic Drive LLC beforehand if intending to use one of our product for the aforementioned applications.

Fail-safe devices that prevent an accident must be designed into the equipment when the products are used in any equipment that could result in personal injury or damage to property in the event of product failure.

Design Precaution: Be certain to read the catalog when designing the equipment.	
 Caution	<p>Use only in the proper environment.</p> <ul style="list-style-type: none"> ● Please ensure to comply with the following environmental conditions: <ul style="list-style-type: none"> • Ambient temperature 0 to 40°C • No splashing of water or oil • Do not expose to corrosive or explosive gas • No dust such as metal powder
 Caution	<p>Install the equipment properly.</p> <ul style="list-style-type: none"> ● Carry out the assembly and installation precisely as specified in the catalog. ● Observe our recommended fastening methods (including bolts used and tightening torques). ● Operating the equipment without precise assembly can cause problems such as vibration, reduction in life, deterioration of precision and product failure.
 Caution	<p>Install the equipment with the required precision.</p> <ul style="list-style-type: none"> ● Design and assemble parts to keep all catalog recommended tolerances for installation. ● Failure to hold the recommended tolerances can cause problems such as vibration, reduction in life, deterioration of precision and product failure.
 Caution	<p>Use the specified lubricant.</p> <ul style="list-style-type: none"> ● Using other than our recommended lubricant can reduce the life of the product. Replace the lubricant as recommended. ● Gearheads are factory lubricated. Do not mix installed lubricant with other kinds of grease.

Operational Precaution: Be certain to read the catalog before operating the equipment.	
 Caution	<p>Use caution when handling the product and parts.</p> <ul style="list-style-type: none"> ● Do not hit the gear or any part with a hammer. ● If you use the equipment in a damaged condition, the gearhead may not perform to catalog specifications. It can also cause problems including product failure.
 Caution	<p>Operate within the allowable torque range.</p> <ul style="list-style-type: none"> ● Do not apply torque exceeding the momentary peak torque. Applying excess torque can cause problems such as loosened bolts, generation of backlash and product failure. ● An arm attached directly to the output shaft that strikes a solid object can damage the arm or cause the output of the gearhead to fail.
 Caution	<p>Do not alter or disassemble the product or parts.</p> <ul style="list-style-type: none"> ● Harmonic Planetary® and Harmonic Drive® products are manufactured as matched sets. Catalog ratings may not be achieved if the component parts are interchanged.
 Caution	<p>Do not disassemble the products.</p> <ul style="list-style-type: none"> ● Do not disassemble and reassemble the products. Original performance may not be achieved.
 Warning	<p>Do not use your finger to turn the gear.</p> <ul style="list-style-type: none"> ● Do not insert your finger into the gear under any circumstances. The finger may get caught in the gear causing an injury.
 Caution	<p>Stop operating the system if any abnormality occurs.</p> <ul style="list-style-type: none"> ● Shut down the system promptly if any abnormal sound or vibration is detected, the rotation has stopped, an abnormally high temperature is generated, an abnormal motor current value is observed or any other anomalies are detected. Continuing to operate the system may adversely affect the product or equipment. ● Please contact our sales office or distributor if any anomaly is detected.
 Warning	<p>Large sizes (45, 50 and 65) are heavy. Use caution when handling.</p> <ul style="list-style-type: none"> ● They are heavy and may cause a lower-back injury or an injury if dropped on a hand or foot. Wear protective shoes and back support when handling the product.
 Caution	<ul style="list-style-type: none"> ● Rust-proofing was applied before shipping. However, please note that rusting may occur depending on the customers' storage environment. ● Although black oxide finish is applied to some of our products, it does not guarantee that rust will not form.

Handling Lubricant	
 Warning	<p>Precautions on handling lubricants</p> <ul style="list-style-type: none"> ● Lubricant in the eye can cause inflammation. Wear protective glasses to prevent it from getting in your eye. ● Lubricant coming in contact with the skin can cause inflammation. Wear protective gloves when you handle the lubricant to prevent it from contacting your skin. ● Do not ingest (to avoid diarrhea and vomiting). ● Use caution when opening the container. There may be sharp edges that can cut your hand. Wear protective gloves. ● Keep lubricant out of reach of children.
 Caution	<p>Disposal of waste oil and containers</p> <ul style="list-style-type: none"> ● Follow all applicable laws regarding waste disposal. Contact your distributor if you are unsure how to properly dispose of the material. ● Do not apply pressure to an empty container. The container may explode. ● Do not weld, heat, drill or cut the container. This may cause residual oil to ignite or cause an explosion.
 Warning	<p>First-aid</p> <ul style="list-style-type: none"> ● Inhalation: Remove exposed person to fresh air if adverse effects are observed. ● Ingestion: Seek immediate medical attention and do not induce vomiting unless directed by medical personnel. ● Eyes: Flush immediately with water for at least 15 minutes. Get immediate medical attention. ● Skin: Wash with soap and water. Get medical attention if irritation develops.
 Caution	<p>Storage</p> <ul style="list-style-type: none"> ● Tightly seal the container after use. Store in a cool, dry, dark place. Keep away from open flames and high temperatures.
 Caution	<p>Disposal</p> <p>Please dispose of as industrial waste.</p> <ul style="list-style-type: none"> ● Please dispose of the products as industrial waste when their useful life is over.

Harmonic Drive LLC

Boston US Headquarters

247 Lynnfield Street
Peabody, MA 01960

New York Sales Office

100 Motor Parkway
Suite 116
Hauppauge, NY 11788

California Sales Office

333 W. San Carlos Street
Suite 1070
San Jose, CA 95110

Chicago Sales Office

137 N. Oak Park Ave., Suite 410
Oak Park, IL 60301

T: 800.921.3332

T: 978.532.1800

F: 978.532.9406

www.HarmonicDrive.net

Group Companies

Harmonic Drive Systems, Inc.
6-25-3 Minami-Ohi, Shinagawa-ku
Tokyo 141-0013, Japan

Harmonic Drive AG
Hoenbergstrasse, 14, D-6555
Limburg/Lahn Germany

Harmonic Drive® and HarmonicPlanetary® are registered trademarks and Quick Connect is a trademark of Harmonic Drive LLC. All other trademarks are property of their respective owners.



Sold & Serviced by:

 **ELECTROMATE**

Toll Free Phone: (877) SERV098
Toll Free Fax: (877) SERV099

www.electromate.com
sales@electromate.com

Rev 12-16