

HarmonicDrive®

FHA IP65 480V Rotary Actuator

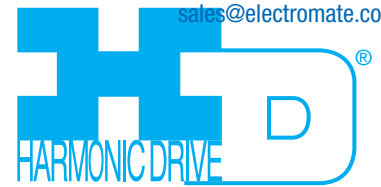

Harmonic Drive® FHA series actuators are now available with IP65 rating and with an additional voltage option of 480VAC.

New! FHA-C Series servo actuators are now available with IP65 protection. Four sizes are available: 17, 25, 32 and 40. The IP65 rated FHA-C actuator is ideal for harsh environments. With IP65 and 480V, the FHA actuator is well suited for machine tool, packaging, and wash-down applications.

These rotary servo actuators utilize Harmonic Drive® precision gears combined with a performance matched brushless servo motor. Encoder options now include EnDat® & HIPERFACE®. The FHA has a low-profile form factor and features a hollow-output shaft. This hollow shaft feature may be used to pass cables, tubing or lasers through the axis of rotation.

The FHA series is designed to operate with a wide range of third-party servo drives including Bosch, Mitsubishi, Siemens, and Kollmorgen.

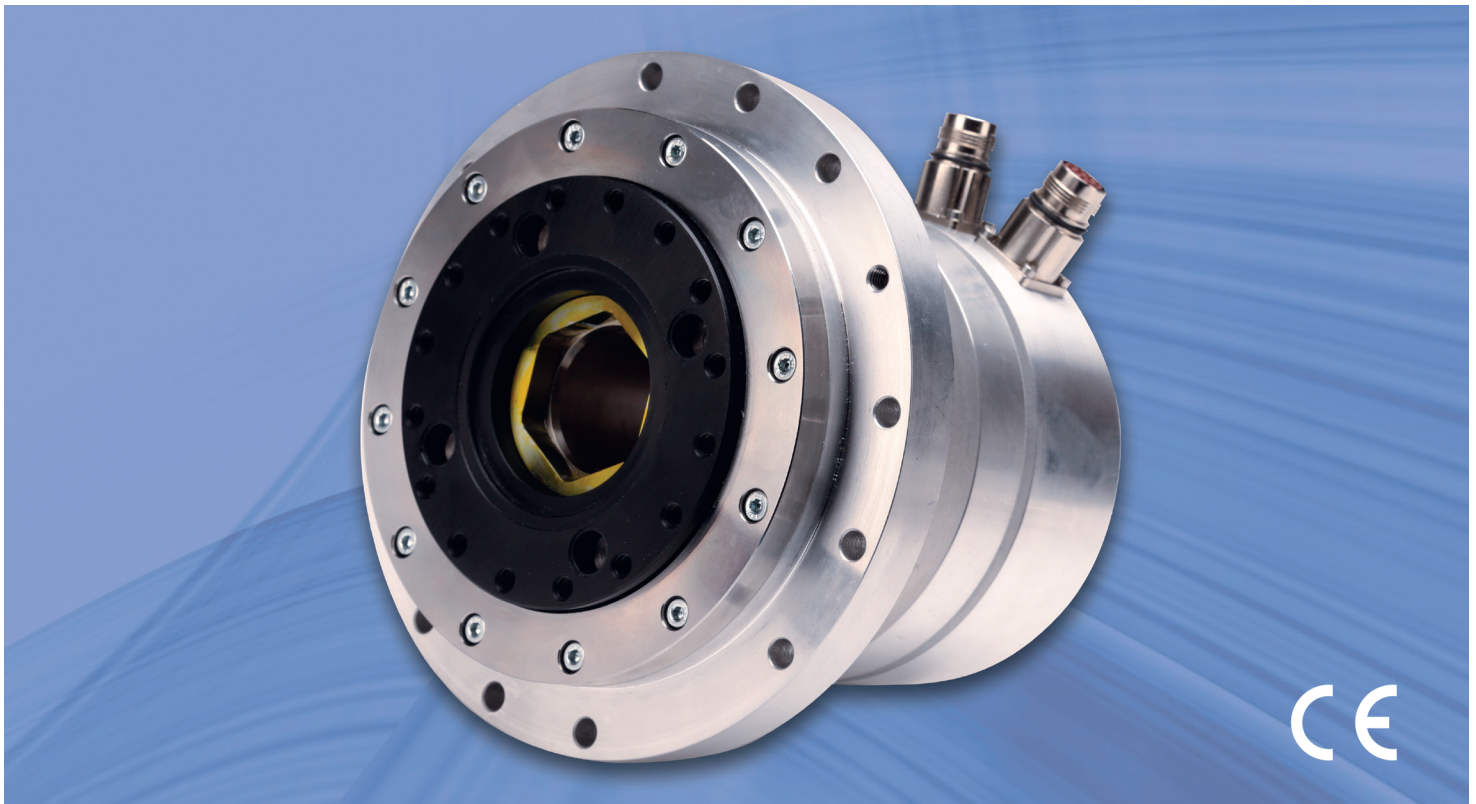

Features

- IP65 Rating
- 480VAC*
- EnDat® & HIPERFACE® Encoder Protocols
- DESINA style flex rated cables

* Contact us for additional voltage options.

Options

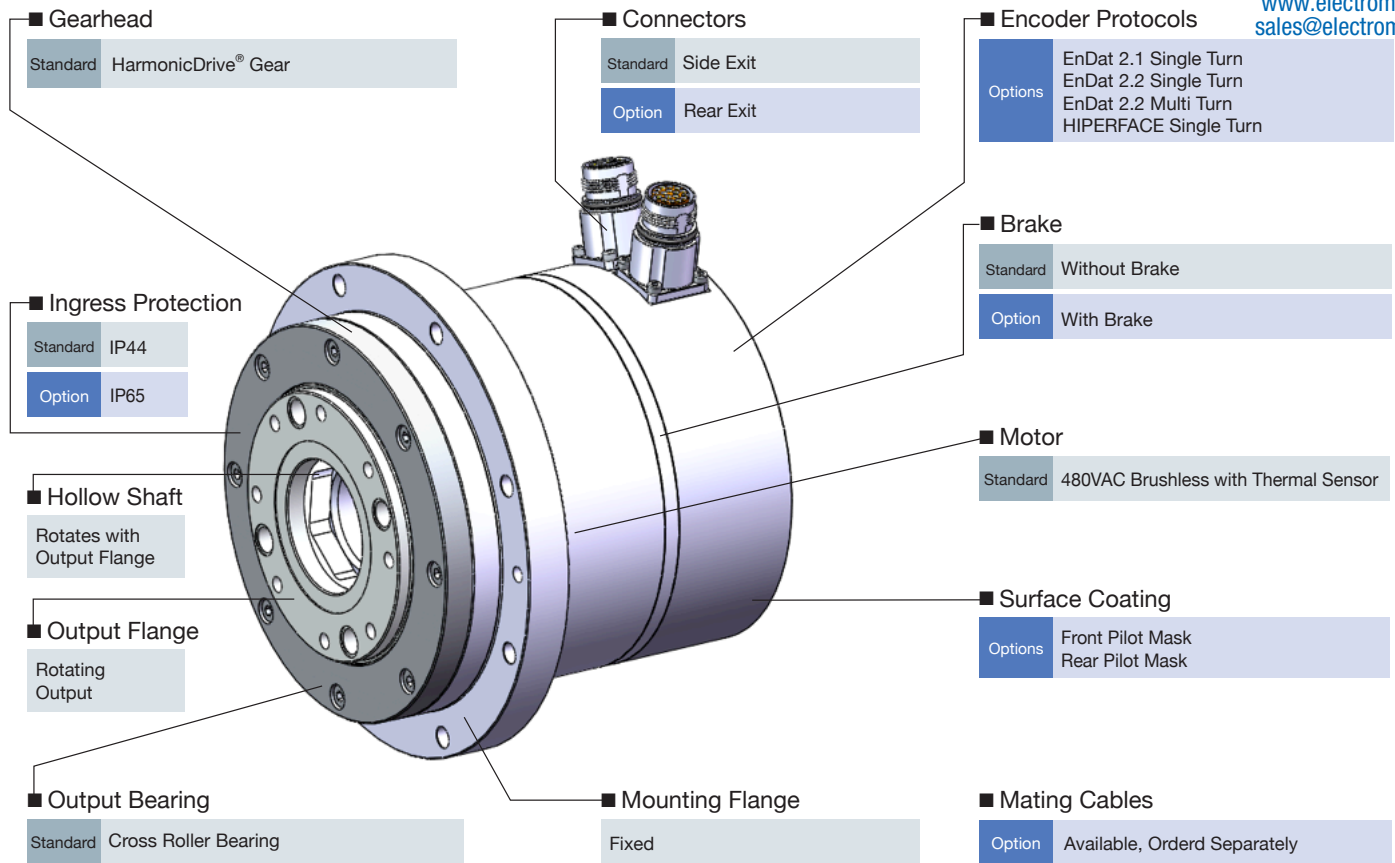

Ordering Code

Series	Size	Design	Ratio	Winding Voltage	Brake	Motor Feedback	Option
FHA	17	C	50	H ¹	B	SE032SC	KP
(1)	(2)	(3)	(4)	(5)	(6)	(7)	(8)

(2) Size	(3) Design	(4) Ratio			(5) Winding Voltage	
17	C	50	100	160	H	680VDC ¹
25						
32						
40						

(7) Motor Feedback	Protocol	Type
SE032SC	EnDat2.1 with Sin-Cos	Single Turn Absolute
SE19b22	EnDat2.2 (Full Digital)	Single Turn Absolute
ME19b22	EnDat2.2 (Full Digital)	Battery Buffered Multi Turn Absolute
SH064SC	HIPERFACE	Single Turn Absolute

(6) Brake Option	
Blank	Without Brake
B	With Brake

(8) Connector and IP65 Option	
S	Connector Side Exit (Standard)
K	Connector Rear Exit
P	IP65 ²
Q F	Front Pilot Mounting
Q B	Back Pilot Mounting
T	Temperature Sensing Provided over EnDat 2.2

¹ Contact us for voltage options.

² Blank = Standard IP44

Mechanical Accuracy

	FHA-17C	FHA-25C	FHA-32C	FHA-40C
1. Axial run-out of output flange	0.010 (0.00039)	0.012 (0.00047)	0.012 (0.00047)	0.014 (0.00047)
2. Radial run-out of output flange	0.010 (0.00039)	0.012 (0.00047)	0.012 (0.00047)	0.014 (0.00047)
3. Parallelism of output flange and mounting flange	0.040 (0.000157)	0.050 (0.000197)	0.050 (0.000197)	0.060 (0.000197)
4. Concentricity of output flange to mounting pilot	0.040 (0.000157)	0.050 (0.000197)	0.050 (0.000197)	0.060 (0.000197)

Note: All values are T.I.R. (Total Indicator Reading).

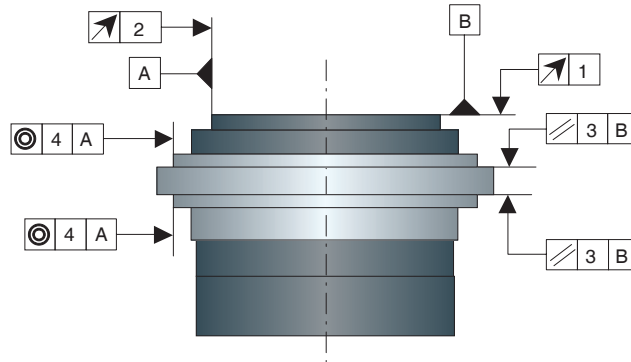

Positioning Accuracy

One-Way Positioning Accuracy

The one-way positioning accuracy is defined as the maximum positional difference between the commanded position and the actual stop position when a series of positioning moves are performed in the same rotation direction. (Refer to JIS B-6201-1987).

The FHA-C actuator incorporates a Harmonic Drive gear which inherently has high rotational position accuracy. Because of the gearing's high ratio, any rotational error at the input (i.e. motor shaft position error or motor feedback error) is reduced by a factor of the ratio (1/ratio) and typically becomes negligible at the output. Therefore most of the error is represented by the transmission error of the Harmonic Drive gear itself.

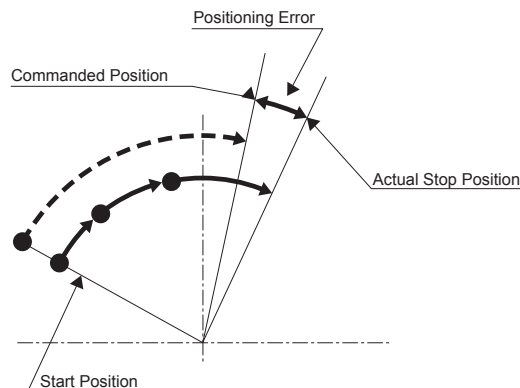

The one-way positioning accuracy is shown in the table below:

Unit: arc-sec

Ratio \ Model	FHA-17C	FHA-25C	FHA-32C	FHA-40C
50:1	60	40	40	40
100:1, 160:1	40	30	30	30

■ Specifications

(Bus voltage 680VDC)

Item	Model	Symbol	FHA-17C-H			FHA-25C-H			FHA-32C-H			FHA-40C-H			
			50	100	160	50	100	160	50	100	160	50	100	160	
Maximum Torque	N•m	TM	39	57	64	151	233	261	281	398	453	500	686	823	
Maximum Current	A _{rms}	IM	1.4	1.1	0.8	3.9	3	2.2	6.5	4.7	3.5	9.3	6.4	5.0	
Continuous Torque	N•m	TC	15	23	23.2	40	72	90	60	153.5	240	90	234	400	
Continuous Current	A _{rms}	IC	0.65	0.55	0.45	1.3	1.3	1.25	2	2	1.9	2.4	2.4	2.4	
Maximum Speed	rpm	NM	96	48	30	90	45	28.1	80	40	25	70	35	21.9	
Torque Constant	N•m/A _{rms}	KT	37	75	120	42	86	138	49	100	160	59	120	193	
Motor EMF Constant (Line-Line)	V _{rms} /(krpm)	V _{EMF}	50			57			67			80			
	V _{rms} /(rad/s)		0.48			0.55			0.64			0.77			
Phase Resistance (20°C, Line-Line)	Ω	R	64			22.4			7.8			5.6			
Phase Inductance (Line-Line)	mH	L	42			20			9.8			11.2			
Number of Pole Pairs	p	P	6			6			6			6			
Allowable Axial Load	kN	LA	9.8			14.7			24.5			39.2			
Allowable Radial Load	kN	LR	2.9			4.9			9.5			14.7			
Allowable Moment Load	Nm	LM	188			370			530			690			
Moment Stiffness	N•m/rad		220 x 10 ³			490 x 10 ³			790 x 10 ³			1400 x 10 ³			
One-Way Positional Accuracy	arc-sec		60	40	40	40	30	30	40	30	30	40	30	30	
Feedback Type ^{*1}			Single-turn absolute (EnDat and HIPERFACE) Multi-turn absolute (EnDat)			Single-turn absolute (EnDat and HIPERFACE) Multi-turn absolute (EnDat)			Single-turn absolute (EnDat and HIPERFACE) Multi-turn absolute (EnDat)			Single-turn absolute (EnDat and HIPERFACE) Multi-turn absolute (EnDat)			
Mass	kg	M	3.3			4.6			6.8			10.8			
Mass (with brake)			3.7			5.4			7.7			12.8			
Motor Inertia (without brake) ^{*2}	EnDat	kg•m ²	J _A	1.37			3.95			7.63			19.3		
	HIPERFACE			1.44			3.65			7.33			19.3		
Motor Inertia (with brake) ^{*2}	EnDat			1.66			4.84			9.00			21.9		
	HIPERFACE			1.73			4.54			8.69			21.9		

The table shows typical values.

*1 Refer to the manual for details.

*2 Inertia shown in this table is at input side. To convert to output side, multiply the inertia by (ratio)²

Outline Dimensions

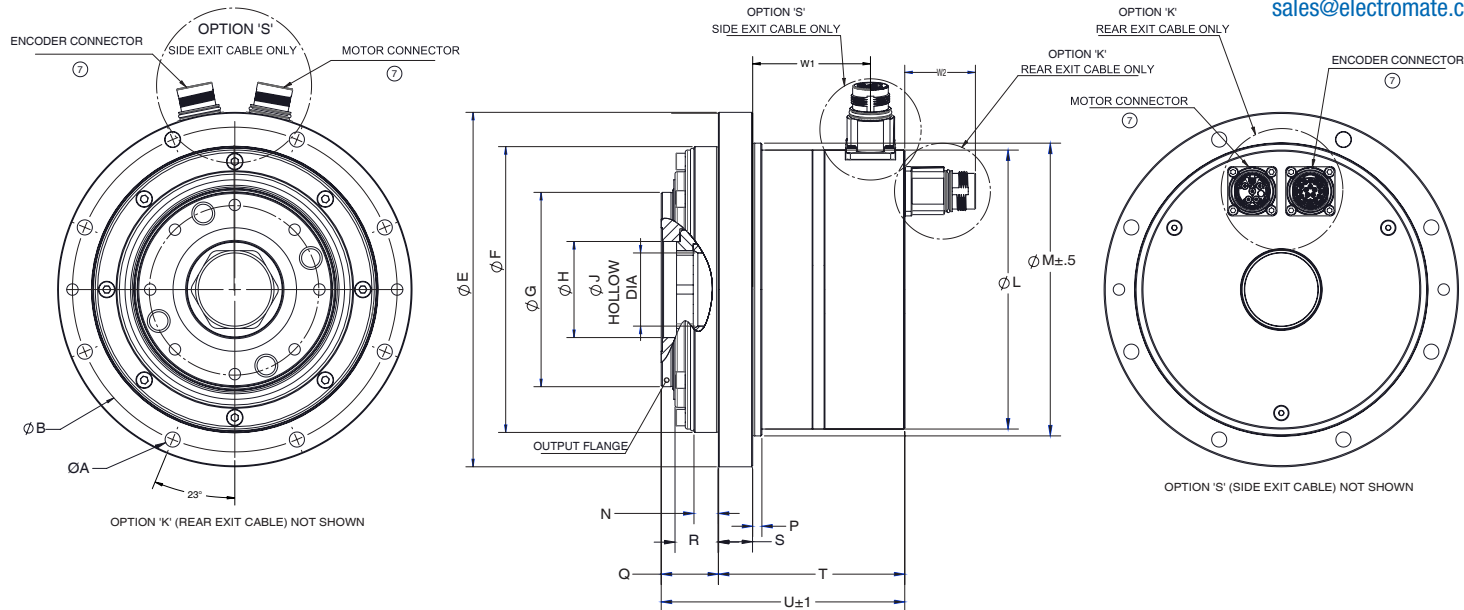

Dimensions

Item	Model	FHA-17C-H	FHA-25C-H	FHA-32C-H	FHA-40C-H
A		6-ø5.5-5.7	8-ø6.6-7.0	12-ø6.6-7.0	8-ø11-11.4
øB		118	142	162	208
øC		60	74	95	112
D		6-M5	8-M6	16-M6	8-M10
		Depth 8	Depth 10	Depth 12	Depth 15
øE		128	155	175	230
øF h7 ¹		105	125	140	185
øG h7		70	85	105	130
øH H7		25	42	60	60
ØJ +/-1		18	32	35	43
øL		106	123	140	163
		113 ⁸			
øM ² ±.5		108	128	148	185
N		6.6	10.7	7.7	11.1
P		4	4	4	8
Q		21	25	22	30
R		15.5	20	17	23
		16.7 ³	20.5 ³	17.6 ³	21.1 ³
S		12	15	18	22
T		84.5	81.5	107	113.8
		100 ⁴	107.5 ⁴	133 ⁴	134.8 ⁴
U		105.5	106.5	129	143.8
		121 ⁴	132.5 ⁴	155 ⁴	164.8 ⁴
W1 ⁵		49	52	71	71.7
		64 ⁴	77 ⁴	97 ⁴	92.7 ⁴
W2 ⁶		31	31	31	31

1) For option "Q" Tolerance is +/- .5. 2) For option "Q" tolerance is h7. 3) With option "P" IP65 output seal. 4) With brake. 5) Option "S" side connectors only. 6) Option "K" rear connectors only. 7) Connector positions are swapped for SH064SC encoder option. 8) Dimension for SH064SC option only.

■ Operating Range

FHA-17C-50-H

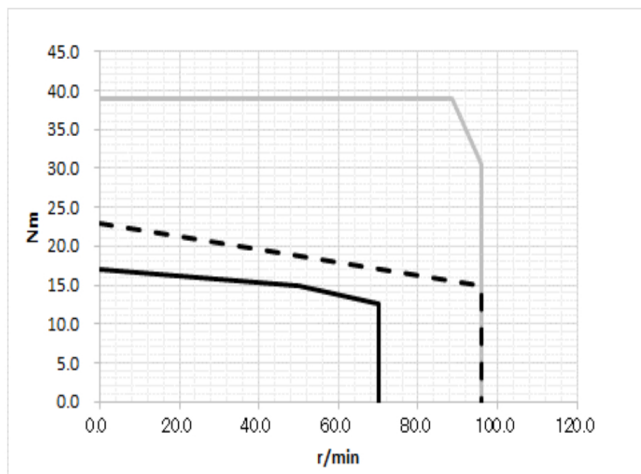

FHA-25C-50-H

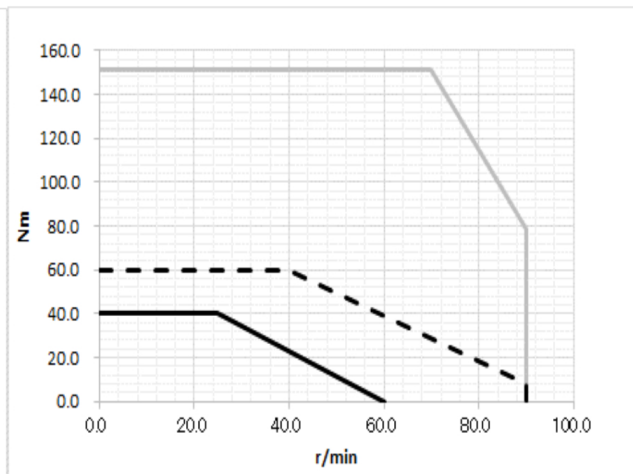

FHA-17C-100-H

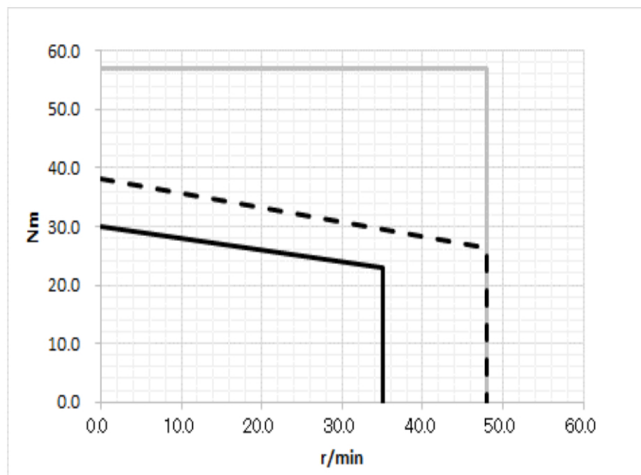

FHA-25C-100-H

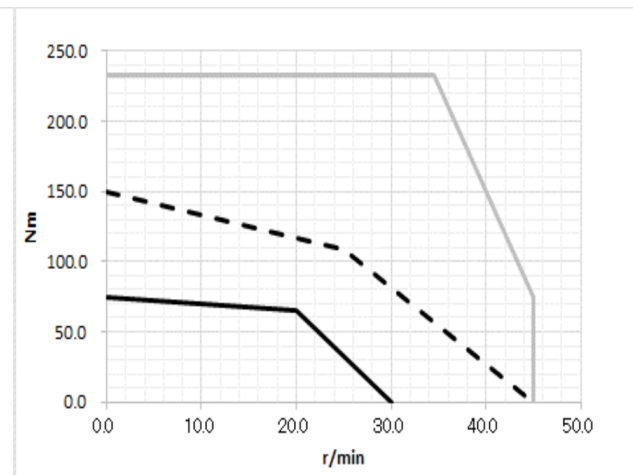

FHA-17C-160-H

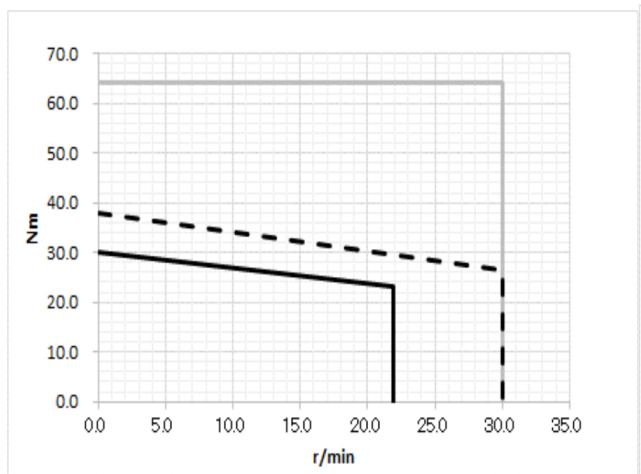

FHA-25C-160-H

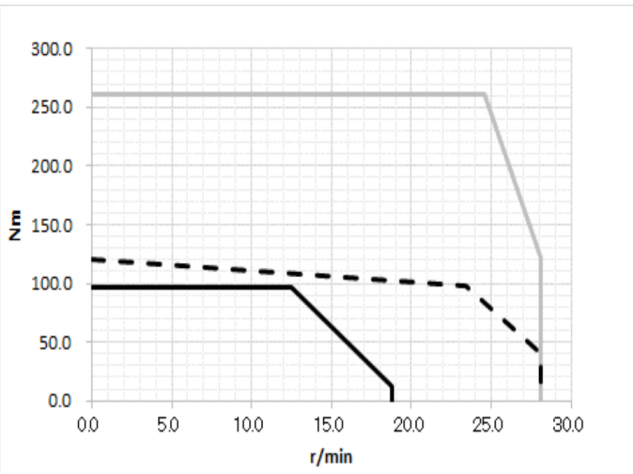

Instantaneous maximum
 50% duty
 Continuous

■ Operating Range

FHA-32C-50-H

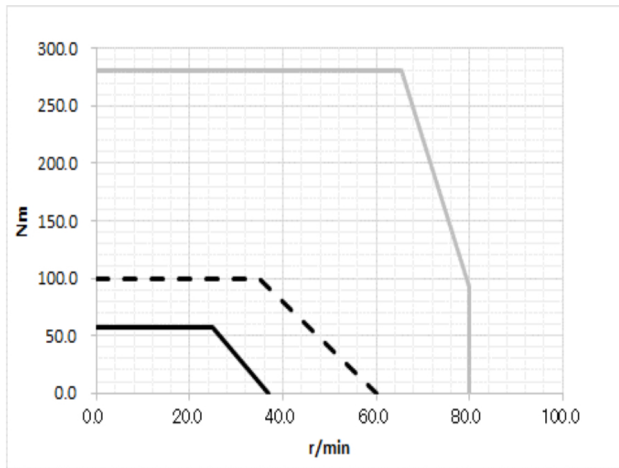

FHA-40C-50-H

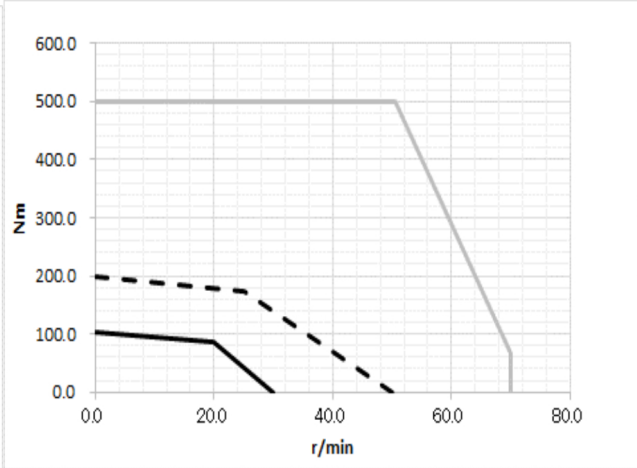

FHA-32C-100-H

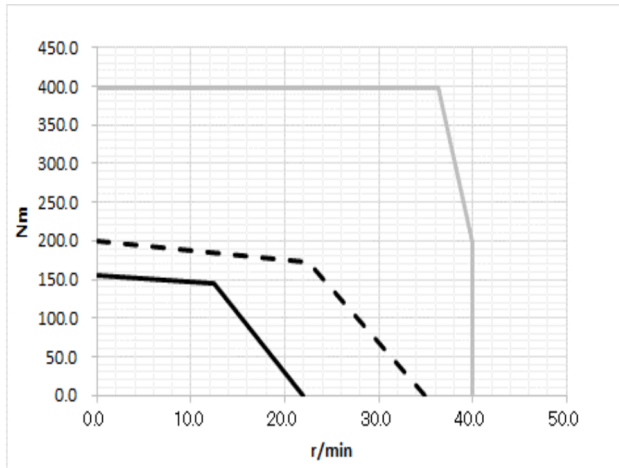

FHA-40C-100-H

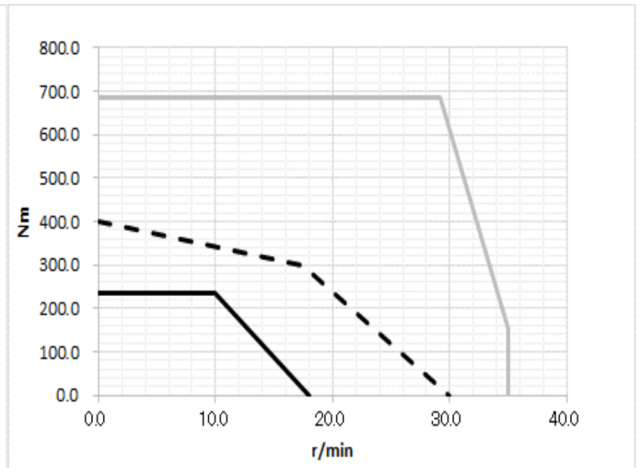

FHA-32C-160-H

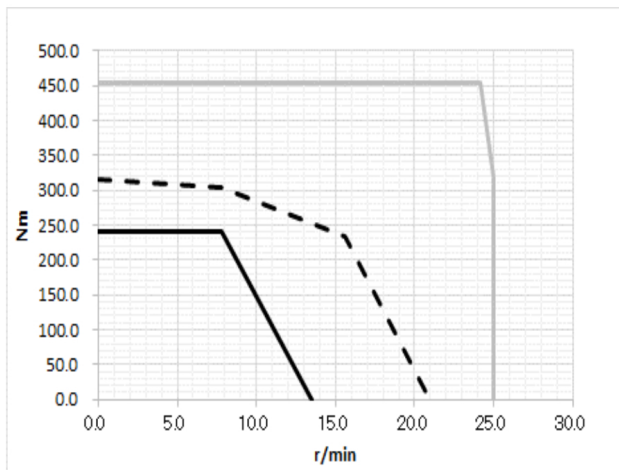

FHA-40C-160-H

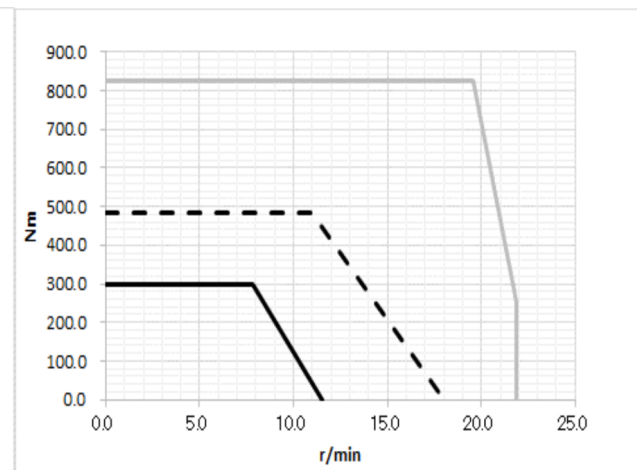

Instantaneous maximum
 50% duty
 Continuous

Motor Wiring M17 Male Connector

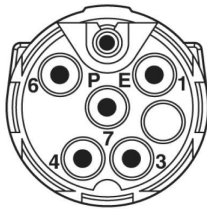

Pin#	Color	Signal Name
1	BLK1	Motor U
3	BLK	Brake 24VDC (No polarity)
4	WHT	Brake 24VDC (No polarity)
6	BLK2	Motor V
7	BLK3	Motor W
PE	GRN/YEL	PE

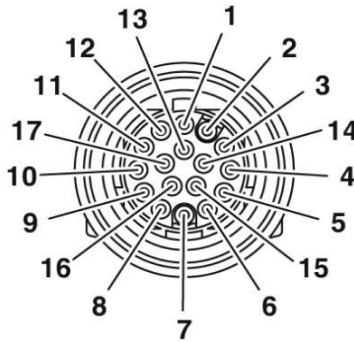

Encoder Feedback M17 Male Connector

Encoder Wiring

Pin#	Mating Cable	Standard Encoder Wiring				Option T Encoder Wiring	
		1590658-ZZ*	1590658-ZZ*	1590658-ZZ*	1590658-ZZ*	1590658-ZZ*	1590658-ZZ*
	Color	SE19b22	SE032SC	ME19b22	SH064SC	SE19b22	ME19b22
1	YEL	-	A+	-	+COS	-	-
2	GRN	-	A-	-	REFCOS	-	-
3	RED	DATA+	DATA+	DATA+	DATA+	DATA+	DATA+
4		-	-	-	-	-	-
5	BLU	CLOCK+	CLOCK+	CLOCK+	-	CLOCK+	CLOCK+
6		-	-	-	-	-	-
7	BRN/BLU	U _p return 0V	U _p return 0V	U _p Return 0V	GND(0V)	U _p return 0V	U _p Return 0V
8	GRN/BLK	Thermal sensor+	Thermal sensor+	Thermal sensor+	Thermal sensor+	-	-
9	GRN/RED	Thermal sensor-	Thermal sensor-	Thermal sensor-	Thermal sensor-	-	-
10	BRN/RED	U _p (5V)	U _p (5V)	U _p (5V)	U _p (12V)	U _p (5V)	U _p (5V)
11	BLK	-	B+	-	+SIN	-	-
12	BRN	-	B-	-	REFSIN	-	-
13	ORG2	DATA-	DATA-	DATA-	DATA -	DATA-	DATA-
14	WHT/BLK	CLOCK-	CLOCK-	CLOCK-	-	CLOCK-	CLOCK-
15	BRN/GRY	Sensor 0V	Sensor 0V	Ubat Return	-	Sensor 0V	Ubat Return
16	BRN/YEL	Sensor Up	Sensor Up	Ubat	-	Sensor Up	Ubat
17	SHIELD	SHIELD	SHIELD	SHIELD	SHIELD	SHIELD	SHIELD

*ZZ = cable length 02 = 2m, 05=5m, 10=10m. Additional lengths are available.

Mating Cable Type: M17

Length [m]	Cable Assembly Part Number	
	Motor	Feedback
2	1590657-02	1590658-02
5	1590657-05	1590658-05
10	1590657-10	1590658-10

Please contact us for additional lengths or for a custom cable or a cable for a specific drive.