

Description	Power Range	
<p>The AB50A100 PWM servo drive is designed to drive brushless and brushed type DC motors at a high switching frequency. A single red/green LED indicates operating status. The drive is fully protected against over-voltage, under-voltage, over-current, over-heating and short-circuits across motor, ground and power leads. Furthermore, the drive can interface with digital controllers or be used stand-alone, and requires only a single unregulated DC power supply. Loop gain, current limit, input gain and offset can be adjusted using 14-turn potentiometers. The offset adjusting potentiometer can also be used as an on-board input signal for testing purposes. This drive can use quadrature encoder inputs, Hall Sensors, or a tachometer for velocity control.</p> <p>See Part Numbering Information on last page of datasheet for additional ordering options. The hardware installation manual for the analog drive family is available for download at <a href="http://www.a-m-c.com">www.a-m-c.com</a>.</p>	Peak Current	
	50 A	
	Continuous Current	25 A
	Supply Voltage	20 - 80 VDC



**Features**

- ▲ Four Quadrant Regenerative Operation
- ▲ DIP Switch Selectable Modes
- ▲ DIP Switch Configurable Loop Tuning
- ▲ DIP Switch Configurable Current Scaling
- ▲ DIP Switch Configurable Tachometer Scaling
- ▲ Selectable Inhibit Logic
- ▲ High Switching Frequency
- ▲ Digital Fault Output Monitor
- ▲ On-Board Test Potentiometer
- ▲ Offset Adjustment Potentiometer
- ▲ Adjustable Input Gain
- ▲ Selectable 120/60 Hall Commutation Phasing
- ▲ Encoder Velocity Mode
- ▲ Hall Velocity Mode
- ▲ Velocity Monitor Output
- ▲ Current Monitor Output
- ▲ Drive Status LED

**MODES OF OPERATION**

- Current
- Encoder Velocity
- Hall Velocity
- Tachometer Velocity
- Duty Cycle (Open Loop)

**COMMAND SOURCE**

- ±10 V Analog

**FEEDBACK SUPPORTED**

- Hall Sensors
- Incremental Encoder
- Tachometer (±60VDC)

**COMPLIANCES & AGENCY APPROVALS**

- UL
- cUL
- CE Class A (LVD)
- CE Class A (EMC)
- RoHS II

**BLOCK DIAGRAM AND AGENCY APPROVALS**

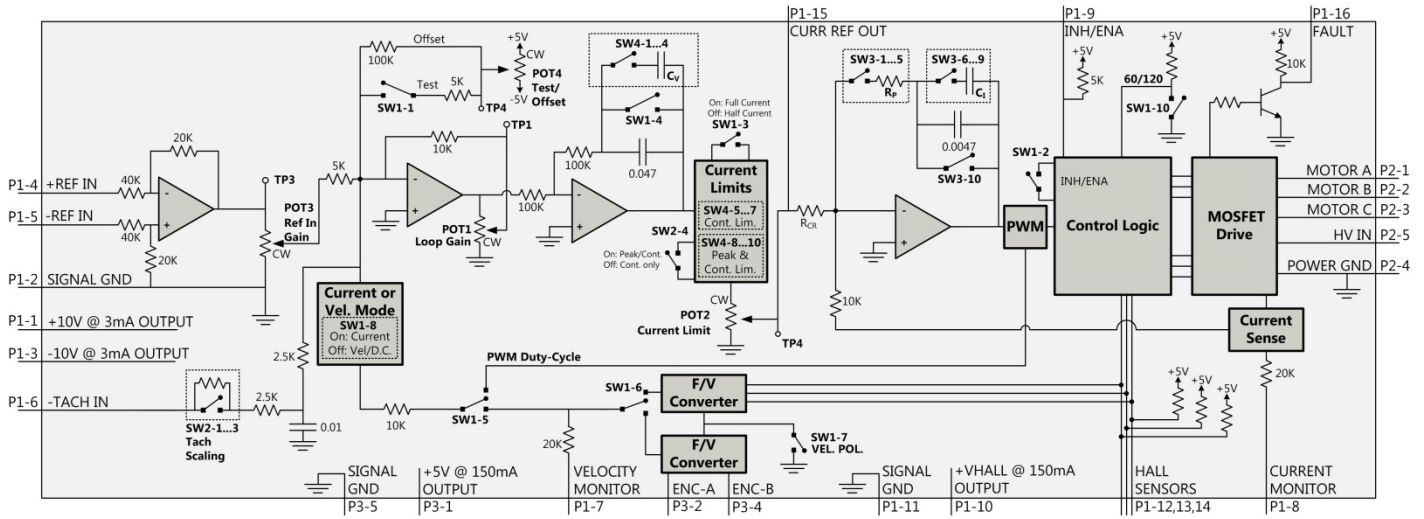

Mode	SW1-4	SW1-5	SW1-6	SW1-8	Encoder	Tachometer
Current Mode	ON	OFF	OFF	ON	Not Connected	Not Connected
Duty Cycle Mode	OFF	ON	OFF	OFF	Not Connected	Not Connected
Encoder Velocity Mode	OFF	OFF	OFF	OFF	Connected	Not Connected
Hall Velocity Mode	OFF	OFF	ON	OFF	Not Connected	Not Connected
Tachometer Velocity Mode	OFF	OFF	OFF	OFF	Not Connected	Connected

LED Behavior	Color	Function
Green	Normal Operation	
Red	Fault Condition	

Default mode is Current Mode, with maximum current settings.  
Recommended potentiometer setting for Current Mode is:  
Pot 1 = Full CCW, Pot 2 = Full CW, Pot 3 = Full CW.

**Information on Approvals and Compliances**

	US and Canadian safety compliance with UL 61800-5-1, the industrial standard for adjustable speed electrical power drive systems. UL registered under file number E140173. Note that machine components compliant with UL are considered UL registered as opposed to UL listed as would be the case for commercial products.
	Compliant with European EMC Directive 2004/108/EC on Electromagnetic Compatibility (specifically EN 61000-6-4:2007/A1:2011 for Emissions, Class A and EN 61000-6-2:2005 for Immunity, Performance Criteria A). LVD requirements of Directive 2006/95/EC (specifically, EN 60204-1:2006/A1:2009, a Low Voltage Directive to protect users from electrical shock).
	The RoHS II Directive 2011/65/EU restricts the use of certain substances including lead, mercury, cadmium, hexavalent chromium and halogenated flame retardants PBB and PBDE in electronic equipment.

Sold & Serviced By:



Toll Free Phone (877) SERV098  
Toll Free Fax (877) SERV099  
www.electromate.com  
sales@electromate.com

**SPECIFICATIONS**

		<b>Power Specifications</b>	
Description	Units	Value	
DC Supply Voltage Range	VDC	20 - 80	
DC Bus Over Voltage Limit	VDC	88	
DC Bus Under Voltage Limit	VDC	15	
Maximum Peak Output Current <sup>1</sup>	A	50	
Maximum Continuous Output Current	A	25	
Maximum Continuous Output Power at Continuous Current	W	1900	
Maximum Power Dissipation at Continuous Current	W	100	
Minimum Load Inductance (Line-To-Line) <sup>2</sup>	μH	200	
Internal Bus Capacitance <sup>3</sup>	μF	75	
Low Voltage Supply Outputs	-	±10 VDC (3 mA), +6 VDC (30 mA), +5 VDC (50 mA)	
Switching Frequency	kHz	24	
		<b>Control Specifications</b>	
Description	Units	Value	
Command Sources	-	±10 V Analog	
Feedback Supported	-	Hall Sensors, Incremental Encoder, Tachometer (±60 VDC)	
Commutation Methods	-	Trapezoidal	
Modes of Operation	-	Current, Encoder Velocity, Hall Velocity, Tachometer Velocity, Duty Cycle (Open Loop)	
Motors Supported	-	Three Phase (Brushless), Single Phase (Brushed, Voice Coil, Inductive Load)	
Hardware Protection	-	Over-Current, Over-Temperature, Over-Voltage, Under-Voltage, Short-Circuit (Phase-Phase & Phase-Ground)	
Primary I/O Logic Level	-	5V TTL	
		<b>Mechanical Specifications</b>	
Description	Units	Value	
Agency Approvals	-	CE Class A (EMC), CE Class A (LVD), cUL, RoHS II, UL	
Size (H x W x D)	mm (in)	186.7 x 108.8 x 26.9 (7.35 x 4.28 x 1.10)	
Weight	g (oz)	518 (18.27)	
Heatsink (Base) Temperature Range <sup>4</sup>	°C (°F)	0 - 65 (32 - 149)	
Storage Temperature Range	°C (°F)	-40 - 85 (-40 - 185)	
Form Factor	-	Panel Mount	
P1 Connector	-	16-pin, 2.54 mm spaced, friction lock header	
P2 Connector	-	5-port, 11.10 mm spaced, screw terminal	
P3 Connector	-	5-pin, 2.54 mm spaced, friction lock header	

**Notes**

1. Maximum duration of peak current is ~2 seconds. Peak RMS value must not exceed continuous current rating of the drive.
2. Lower inductance is acceptable for bus voltages well below maximum. Use external inductance to meet requirements.
3. Minimum additional 470 μF / 100 V external electrolytic capacitor between High Voltage and Power Ground is recommended.
4. Additional cooling and/or heatsink may be required to achieve rated performance.

Sold & Serviced By:



Toll Free Phone (877) SERV098

Toll Free Fax (877) SERV099

www.electromate.com

sales@electromate.com

**PIN FUNCTIONS**

P1 - Signal Connector			
Pin	Name	Description / Notes	I/O
1	+10V 3mA OUT	±10 V @ 3 mA low power supply for customer use. Short circuit protected. Reference ground common with signal ground.	O
2	SIGNAL GND		GND
3	-10V 3mA OUT		O
4	+REF IN	Differential Reference Input (±10 V Operating Range, ±15 V Maximum Input)	I
5	-REF IN		I
6	-TACH IN		I
7	VEL MONITOR OUT	Velocity Monitor. Analog output proportional to motor speed. In Encoder Velocity mode, output is proportional to the encoder line frequency. Encoder Velocity scaling is 22 kHz/V. In Hall Velocity mode, output is proportional to the Hall frequency. Hall Velocity scaling is 100 Hz/V.	O
8	CURR MONITOR OUT	Current Monitor. Analog output signal proportional to the actual current output. Scaling is 8.05 A/V by default but may be reduced by half this value by setting DIP switch SW1-3 to OFF (see Hardware Settings section below). Measure relative to power ground.	O
9	INHIBIT / ENABLE	TTL level (+5 V) inhibit/enable input. Pull to ground to inhibit drive (SW1-2 ON). Pull to ground to enable drive (SW1-2 OFF). Inhibit turns off all power devices.	I
10	+V HALL 30mA OUT	Low Power Supply For Hall Sensors (+5 V). Internally connected to P3-1. Total current available from P1-10 and P3-1 is 150mA. Referenced to signal ground. Short circuit protected.	O
11	GND	Signal Ground	GND
12	HALL 1	Single-ended Hall/Commutation Sensor Inputs (+5 V logic level)	I
13	HALL 2		I
14	HALL 3		I
15	CURR REF OUT	Measures the command signal to the internal current-loop. This pin has a maximum output of ±7.25 V when the drive outputs maximum peak current. Measure relative to power ground.	O
16	FAULT OUT	TTL level (+5 V) output becomes high when power devices are disabled due to at least one of the following conditions: inhibit, invalid Hall state, output short circuit, over voltage, under voltage, over temperature, power-up reset.	O

P2 - Power Connector			
Pin	Name	Description / Notes	I/O
1	A	Motor Phase A	O
2	B	Motor Phase B	O
3	C	Motor Phase C	O
4	POWER GND	Power Ground (Common With Signal Ground)	PGND
5	HIGH VOLTAGE	DC Power Input. An external electrolytic capacitor connected between High Voltage and Power Ground as close to the drive as possible is recommended (at least 470 μF / 100 V).	I

P3 - Feedback Connector			
Pin	Name	Description / Notes	I/O
1	+5V	Low Power Supply For Encoder (+5 V). Internally connected to P1-10. Total current available from P3-1 and P1-10 is 150mA. Referenced to signal ground. Short circuit protected.	O
2	CHANNEL A	Single-ended encoder channel A input. +5 V logic level.	I
3	NC	Not Connected (Reserved)	-
4	CHANNEL B	Single-ended encoder channel B input. +5 V logic level.	I
5	SIGNAL GND	Signal Ground	SGND

Sold & Serviced By:



Toll Free Phone (877) SERV098

Toll Free Fax (877) SERV099

www.electromate.com

sales@electromate.com

**HARDWARE SETTINGS**

**Configuration Switch Functions**

SW1	Description	Setting	
		On	Off
1	Test/Offset. Switches the function of the Test/Offset pot between an on-board command input for testing or a command offset adjustment. OFF by default.	Test	Offset
2	Inhibit logic. Sets the logic level of inhibit pins.	Drive Inhibit is active low	Drive Inhibit is active high
3	Current scaling. When OFF, increases sensitivity of current sense thus reducing both peak and continuous current limit by 50%. The scaling of the current monitor output signal becomes ½ its ordinary value when this switch is OFF.	Full-current	Half-current
4	Outer loop integration. Activates or deactivates integration. ON, by default, for current mode and OFF for other modes.	Inactive	Active
5	Mode selection. See mode selection table below.	-	-
6		-	-
7	Velocity feedback polarity. Changes the polarity of the internal feedback signal and the velocity monitor output signal. This may be required to prevent a motor run-away condition.	Standard	Inverted
8	Mode selection. See mode selection table below.	-	-
9	Reserved	-	-
10	60/120 degree commutation phasing setting	120 degrees	60 degrees

Mode Selection Table

	SW1-4	SW1-5	SW1-6	SW1-8	Tachometer
CURRENT	ON	OFF	OFF	ON	Not Connected
DUTY CYCLE	OFF	ON	OFF	OFF	Not Connected
ENCODER VELOCITY	OFF	OFF	OFF	OFF	Not Connected
HALL VELOCITY	OFF	OFF	ON	OFF	Not Connected
TACHOMETER VELOCITY	OFF	OFF	OFF	OFF	Connected

(Note: Drive cover must be removed to access SW2)

SW2	Description	Setting	
		On	Off
1	Tachometer Input Voltage Scaling. Adjusts the maximum range of the tachometer input.	Max tachometer input values from 5V to 61V. See Maximum Tachometer Input Voltage Table below.	
2			
3			
4	Configures the drive to output either peak and continuous current values, or continuous current only.	Peak and Continuous Current	Continuous Current Only

Maximum Tachometer Input Voltage Table

Default switch settings are shaded.

Switch	Maximum Tachometer Input Voltage (±VDC)							
	61	53	45	37	29	21	13	5
SW2-1	OFF	ON	OFF	ON	OFF	ON	OFF	ON
SW2-2	OFF	OFF	ON	ON	OFF	OFF	ON	ON
SW2-3	OFF	OFF	OFF	OFF	ON	ON	ON	ON

Sold & Serviced By:



Toll Free Phone (877) SERV098

Toll Free Fax (877) SERV099

www.electromate.com

sales@electromate.com

(Note: Drive cover must be removed to access SW4)

SW4	Description	Setting
1	Advanced Tuning (Velocity Loop Integrator Capacitance)	See SW4 table in Loop Tuning Switch Functions section for switch settings and corresponding capacitance values.
2		
3		
4		
5	Continuous Current Scaling. Configures the drive to set the continuous current limit at a percentage of the drive peak current limit.	See Continuous Current Scaling Table below for switch settings and corresponding values.
6		
7		
8	Peak and Continuous Current Scaling. Adjusts both the peak and continuous drive current limits.	See Peak and Continuous Current Scaling Table below for switch settings and corresponding values.
9		
10		

*Continuous Current Scaling Table*

Default switch settings are shaded.

Switch	Continuous Current Scaling (% of Peak Current)							
	50	43.6	37.6	31.6	25.6	19.7	13.7	7.75
SW4-5	OFF	ON	OFF	ON	OFF	ON	OFF	ON
SW4-6	OFF	OFF	ON	ON	OFF	OFF	ON	ON
SW4-7	OFF	OFF	OFF	OFF	ON	ON	ON	ON

*Peak and Continuous Current Scaling Table*

Default switch settings are shaded.

Switch	Peak and Continuous Current Scaling* ( $A_{peak}$ )							
	50	43.63	38.60	34.61	31.37	28.67	26.40	24.47
SW4-8	OFF	ON	OFF	ON	OFF	ON	OFF	ON
SW4-9	OFF	OFF	ON	ON	OFF	OFF	ON	ON
SW4-10	OFF	OFF	OFF	OFF	ON	ON	ON	ON

\*Note: By default, the continuous current limit will be half of the peak value. However, DIP Switches SW4-5, 6, and 7 can set the continuous limit to a lesser percentage of the peak value.

**Potentiometer Functions**

Potentiometer	Description	Turning CW
1	Loop gain adjustment for duty cycle / velocity modes. Turn this pot fully CCW in current mode.	Increases gain
2	Current limit. It adjusts both continuous and peak current limit while maintaining their ratio.	Increases limit
3	Reference gain. Adjusts the ratio between input signal and output variables (voltage, current, or velocity).	Increases gain
4	Offset / Test. Used to adjust any imbalance in the input signal or in the amplifier. Can also be used as an on-board signal source for testing purposes.	Adjusts offset in negative direction

Note: Potentiometers are approximately linear and have 12 active turns with 1 inactive turn on each end. Test points are provided on the drive PCB near each potentiometer to measure the potentiometer value.

**Loop Tuning Switch Functions**

In general, the drive will not need to be further tuned beyond the default configuration. However, for applications requiring more precise tuning, DIP switches can be used to adjust the current and velocity loop tuning values. Some general rules of thumb to follow when tuning the drive are:

- A larger resistor value will increase the proportional gain, and therefore create a faster response time.
- A larger capacitor value will increase the integration time, and therefore create a slower response time.

Proper tuning will require careful observation of the loop response on a digital oscilloscope to find optimal DIP switch settings for the specific application.

**(Note: Drive cover must be removed to access SW3 and SW4)**

SW3 DIP switches add additional resistance and capacitance to the current loop tuning circuitry. SW3 switches 1-5 add additional series resistance to the current loop gain resistor, and SW3 switches 6-10 add additional parallel capacitance to the current loop integrator capacitor. The resulting capacitance and resistance values are given in the tables below along with the appropriate DIP switch settings. The default switch settings are shaded in the SW3 tables below.

SW3																
Switch	Current Loop Proportional Gain Resistance Options (kΩ)															
	10	26	42	58	74	91	107	123	135	151	167	183	199	216	232	248
SW3-1	ON	OFF	ON	OFF	ON	OFF	ON	OFF	ON	OFF	ON	OFF	ON	OFF	ON	OFF
SW3-2	ON	ON	OFF	OFF	ON	ON	OFF	OFF	ON	ON	OFF	OFF	ON	ON	OFF	OFF
SW3-3	ON	ON	ON	ON	OFF	OFF	OFF	OFF	ON	ON	ON	ON	OFF	OFF	OFF	OFF
SW3-4	ON	ON	ON	ON	ON	ON	ON	ON	OFF	OFF	OFF	OFF	OFF	OFF	OFF	OFF
SW3-5	ON	ON	ON	ON	ON	ON	ON	ON	ON	ON	ON	ON	ON	ON	ON	ON
<b>Switch (continued)</b>	<b>260</b>	<b>276</b>	<b>292</b>	<b>308</b>	<b>324</b>	<b>341</b>	<b>357</b>	<b>373</b>	<b>385</b>	<b>401</b>	<b>417</b>	<b>433</b>	<b>449</b>	<b>466</b>	<b>482</b>	<b>498</b>
SW3-1	ON	OFF	ON	OFF	ON	OFF	ON	OFF	ON	OFF	ON	OFF	ON	OFF	ON	OFF
SW3-2	ON	ON	OFF	OFF	ON	ON	OFF	OFF	ON	ON	OFF	OFF	ON	ON	OFF	OFF
SW3-3	ON	ON	ON	ON	OFF	OFF	OFF	OFF	ON	ON	ON	ON	OFF	OFF	OFF	OFF
SW3-4	ON	ON	ON	ON	ON	ON	ON	ON	OFF	OFF	OFF	OFF	OFF	OFF	OFF	OFF
SW3-5	OFF	OFF	OFF	OFF	OFF	OFF	OFF	OFF	OFF	OFF	OFF	OFF	OFF	OFF	OFF	OFF

SW3																	
Switch	Current Loop Integrator Capacitance Options (μF)																
	.0047	.0169	.0314	.0436	.0564	.0686	.0831	.0953	.1094	.1216	.1361	.1483	.1611	.1733	.1878	.2000	SHORT
SW3-6	OFF	ON	OFF	ON	OFF	ON	OFF	ON	OFF	ON	OFF	ON	OFF	ON	OFF	ON	ON
SW3-7	OFF	OFF	ON	ON	OFF	OFF	ON	ON	OFF	OFF	ON	ON	OFF	OFF	ON	ON	ON
SW3-8	OFF	OFF	OFF	OFF	ON	ON	ON	ON	OFF	OFF	OFF	OFF	ON	ON	ON	ON	ON
SW3-9	OFF	OFF	OFF	OFF	OFF	OFF	OFF	OFF	ON	ON	ON	ON	ON	ON	ON	ON	ON
SW3-10	OFF	OFF	OFF	OFF	OFF	OFF	OFF	OFF	OFF	OFF	OFF	OFF	OFF	OFF	OFF	OFF	ON

SW4 DIP switches 1-4 add additional parallel capacitance to the velocity loop integrator capacitor. The resulting capacitance values are given in the table below along with the appropriate DIP switch settings. The default switch settings are shaded in the SW4 table below.

SW4																
Switch	Velocity Loop Integrator Capacitance Options (μF)															
	0.047	0.147	0.294	0.421	0.544	0.671	0.791	0.918	1.047	1.194	1.341	1.468	1.591	1.718	1.838	1.965
SW4-1	OFF	ON	OFF	ON	OFF	ON	OFF	ON	OFF	ON	OFF	ON	OFF	ON	OFF	ON
SW4-2	OFF	OFF	ON	ON	OFF	OFF	ON	ON	OFF	OFF	ON	ON	OFF	OFF	ON	ON
SW4-3	OFF	OFF	OFF	OFF	ON	ON	ON	ON	OFF	OFF	OFF	OFF	ON	ON	ON	ON
SW4-4	OFF	OFF	OFF	OFF	OFF	OFF	OFF	OFF	ON	ON	ON	ON	ON	ON	ON	ON

Note: The velocity loop integrator capacitor can be shorted entirely by setting SW1-4 to ON.

**MECHANICAL INFORMATION**

**P1 - Signal Connector**

Connector Information	16-pin, 2.54 mm spaced, friction lock header	
Mating Connector	Details	Molex: P/N 22-01-3167 (connector) and P/N 08-50-0114 (insert terminals)
	Included with Drive	Yes

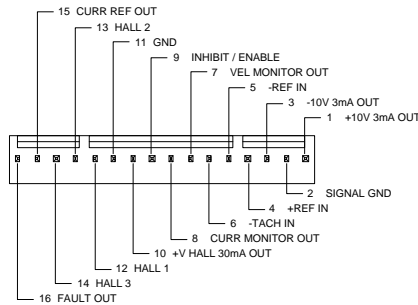

**P2 - Power Connector**

Connector Information	5-port, 11.10 mm spaced, screw terminal	
Mating Connector	Details	N/A
	Included with Drive	N/A

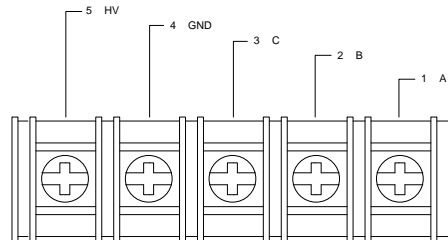

**P3 - Feedback Connector**

Connector Information	5-pin, 2.54 mm spaced, friction lock header	
Mating Connector	Details	Molex: P/N 22-01-3057 (connector) and P/N 08-50-0114 (insert terminals)
	Included with Drive	Yes

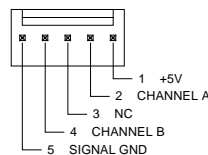

Sold & Serviced By:



Toll Free Phone (877) SERV098

Toll Free Fax (877) SERV099

[www.electromate.com](http://www.electromate.com)

[sales@electromate.com](mailto:sales@electromate.com)



**MOUNTING DIMENSIONS**

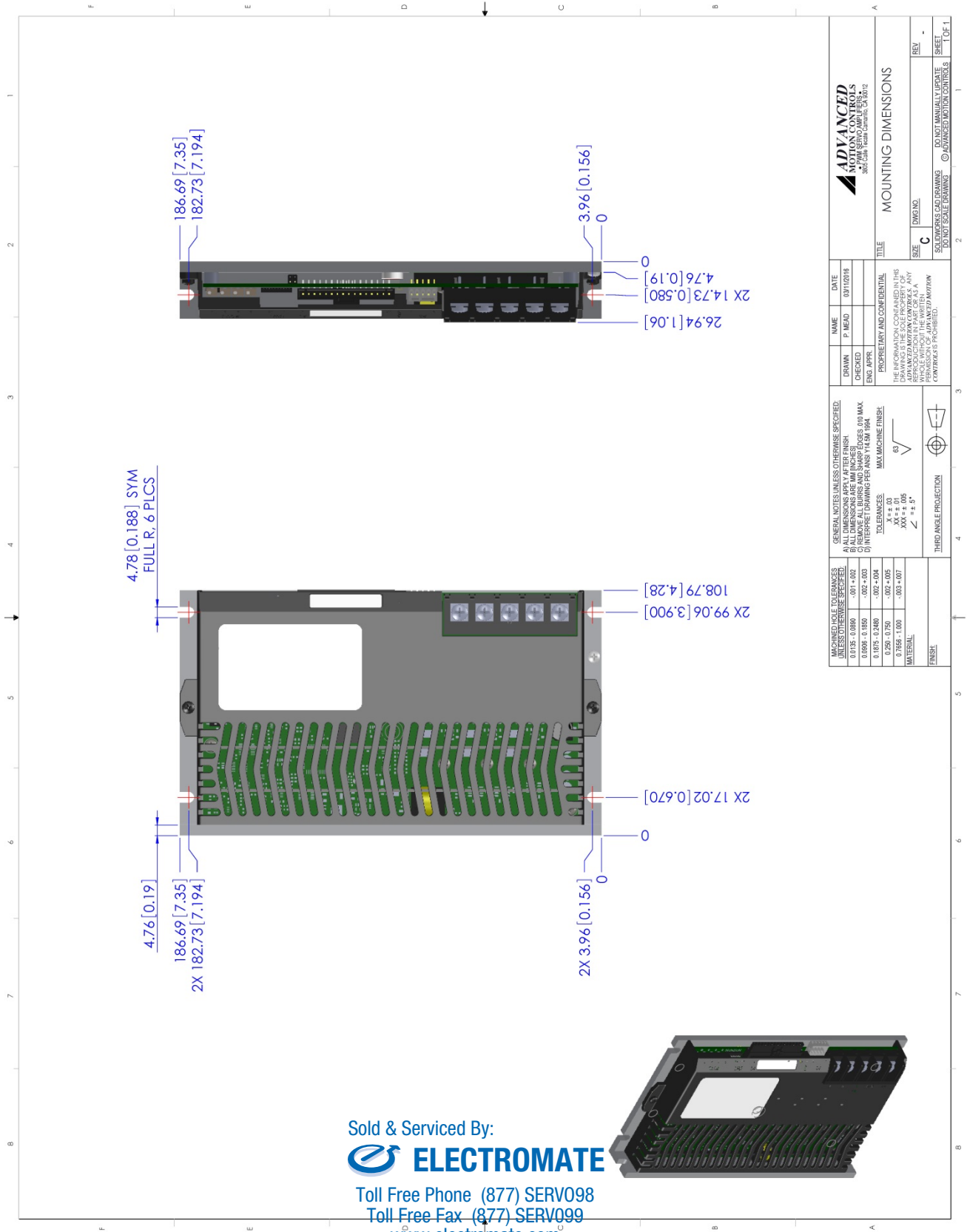

<b>ADVANCED</b> MOTION CONTROLS 380 Glen Vista Center, CA 95012		<b>TITLE</b> MOUNTING DIMENSIONS	
<b>NAME</b> P. HEAD 03/11/2018	<b>DATE</b> 03/11/2018	<b>SIZE</b> C	<b>REV.</b> -
<b>DRAWN</b> 	<b>CHECKED</b> 	<b>DWG. NO.</b> 	<b>SHEET</b> 
<b>ENG. APPR.</b> 	<b>PROPRIETARY AND CONFIDENTIAL</b> THE INFORMATION CONTAINED IN THIS DRAWING IS THE SOLE PROPERTY OF ADVANCED MOTION CONTROLS. NO REPRODUCTION OR TRANSMISSION OF ANY PART OF THIS DRAWING WITHOUT THE WRITTEN PERMISSION OF ADVANCED MOTION CONTROLS IS PROHIBITED.	<b>SOLIDWORKS CAD DRAWING</b> DO NOT MANUALLY UPDATE DO NOT SCALE DRAWING	<b>ADVANCED MOTION CONTROLS</b> © ADVANCED MOTION CONTROLS
<b>MACHINED HOLE TOLERANCES (UNLESS OTHERWISE SPECIFIED):</b> 0.175 - 0.0000    -0.01 + 0.02 0.006 - 0.1850    -0.02 + 0.03 0.175 - 0.2480    -0.02 + 0.04 0.250 - 0.7500    -0.02 + 0.05 0.750 - 1.0000    -0.03 + 0.07	<b>GENERAL NOTES UNLESS OTHERWISE SPECIFIED:</b> A ALL DIMENSIONS APPLY AFTER FINISH B REMOVE ALL BURRS AND SHARP EDGES 0.015 MAX C INTERPRET DRAWING PER ANSI Y14.5M 1994 D TOLERANCES: * * * * *    MAX MACHINE FINISH ** * * *    83 *** * *    106 **** *    126 *****    150 ∠    ± 0.5°	<b>THIRD ANGLE PROJECTION</b>	<b>FINISH</b>

Sold & Serviced By:  
  
 Toll Free Phone (877) SERV098  
 Toll Free Fax (877) SERV099  
 www.electromate.com  
 sales@electromate.com

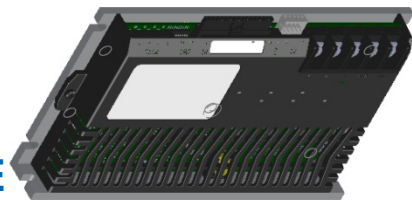

**PART NUMBERING INFORMATION**

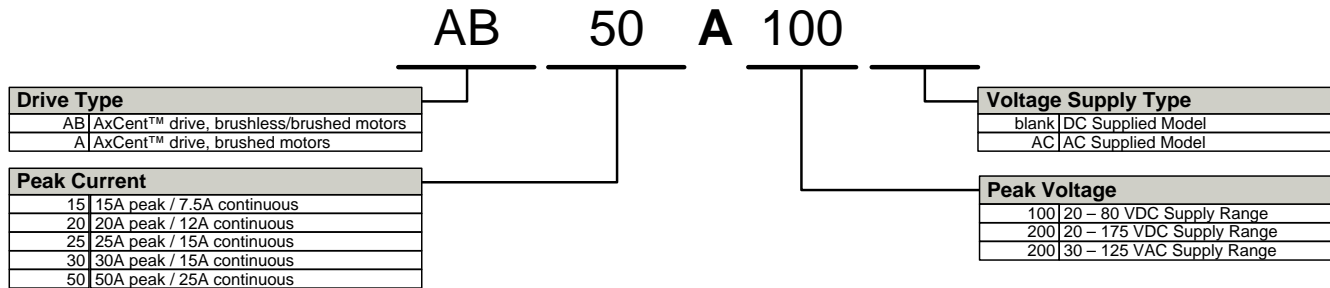

ADVANCED Motion Controls analog series of servo drives are available in many configurations. Note that not all possible part number combinations are offered as standard drives. All models listed in the selection tables of the website are readily available, standard product offerings.

ADVANCED Motion Controls also has the capability to promptly develop and deliver specified products for OEMs with volume requests. Our Applications and Engineering Departments will work closely with your design team through all stages of development in order to provide the best servo drive solution for your system. Equipped with on-site manufacturing for quick-turn customs capabilities, ADVANCED Motion Controls utilizes our years of engineering and manufacturing expertise to decrease your costs and time-to-market while increasing system quality and reliability.

**Examples of Modifications and Customized Products**

- ▲ Integration of Drive into Motor Housing
- ▲ Mount OEM PCB onto Drive Without Cables
- ▲ Multi-axis Configuration for Compact System
- ▲ Custom PCB and Baseplate for Optimized Footprint
- ▲ RTV/Epoxy Components for High Vibration
- ▲ OEM Specified Connectors for Instant Compatibility
- ▲ OEM Specified Silkscreen for Custom Appearance
- ▲ Increased Thermal Limits for High Temp. Operation
- ▲ Integrate OEM Circuitry onto Drive PCB
- ▲ Custom Control Loop Tuned to Motor Characteristics
- ▲ Custom I/O Interface for System Compatibility
- ▲ Preset Switches and Pots to Reduce User Setup
- ▲ Optimized Switching Frequency
- ▲ Ramped Velocity Command for Smooth Acceleration
- ▲ Remove Unused Features to Reduce OEM Cost
- ▲ Application Specific Current and Voltage Limits

Feel free to contact Applications Engineering for further information and details.

**Available Accessories**

ADVANCED Motion Controls offers a variety of accessories designed to facilitate drive integration into a servo system. Visit [www.a-m-c.com](http://www.a-m-c.com) to see which accessories will assist with your application design and implementation.

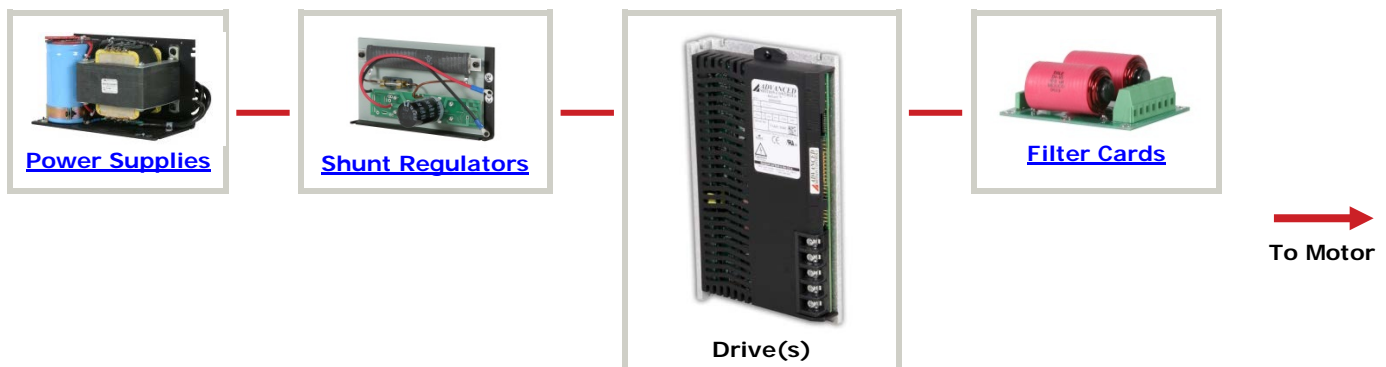

Sold & Serviced By:



Toll Free Phone (877) SERV098

Toll Free Fax (877) SERV099

[www.electromate.com](http://www.electromate.com)

[sales@electromate.com](mailto:sales@electromate.com)