

FT 25-R(L)A

Miniature distance sensors

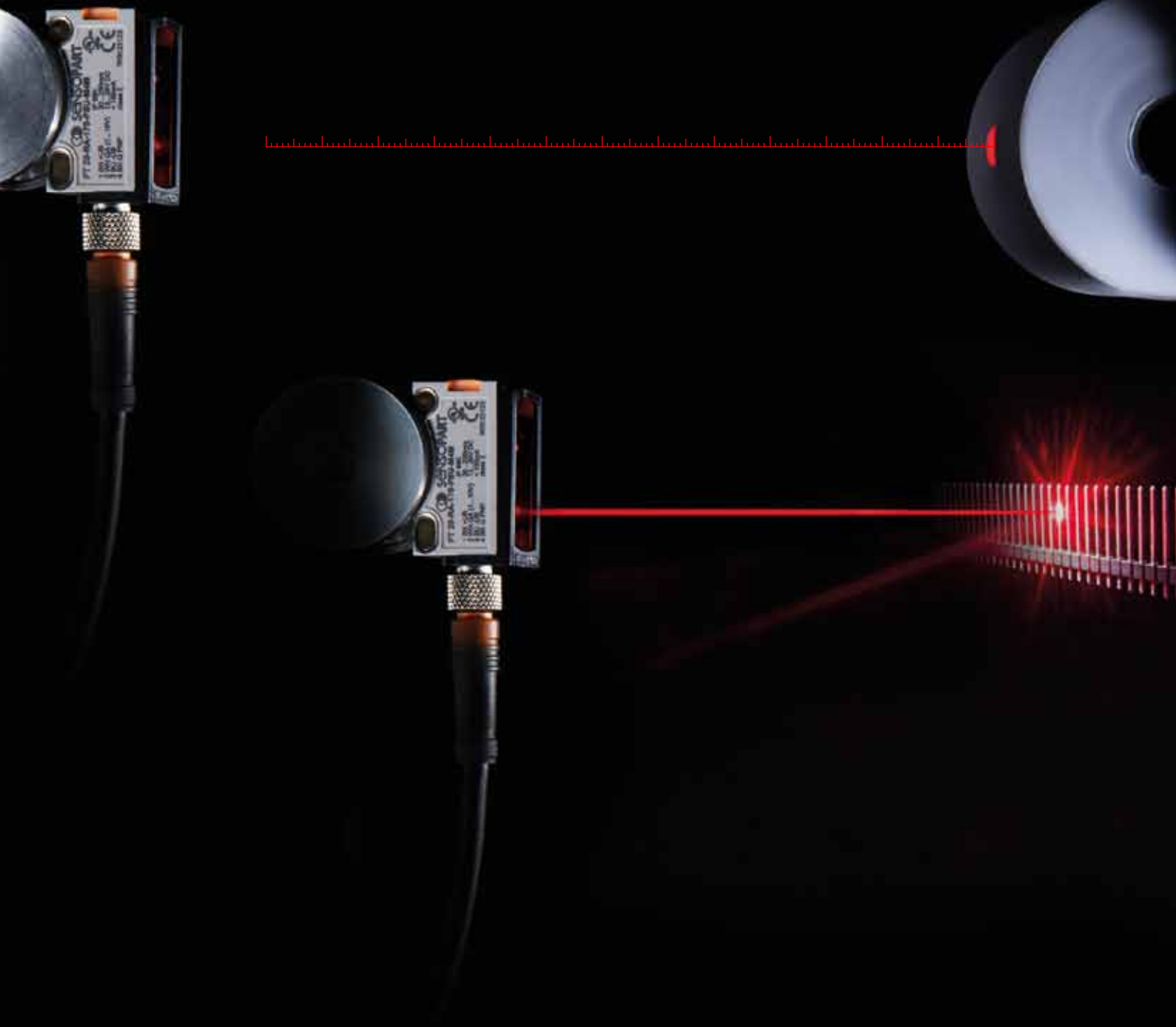

FT 25 – optical short-range distance sensors

The compact class for measurement and regulatory tasks



 made in Germany



FT 25-R(L)A for dancer roll regulation

The precise control of the FT 25-R(L)A ensures a constant tension of the paper roll during unwinding.

TYPICAL FT 25-R(L)A

- Operating range: 20...80 mm / 20...100 mm / 30...200 mm
- Distance sensor with 1 ... 10V analogue output
- Easily integratable ultra-compact ABS housing: 34 x 12 x 20 mm
- High precision and high repeatability – especially for control tasks
- Resolution: from 0.12 mm
- Two adjustable switching points as window mode for 2-point control
- Teach-in operation



In a miniature housing

The FT 25-R(L)A is also suitable for limited installation spaces thanks to its compact dimensions of 34 x 12 x 20 mm.

In addition to its analogue voltage output the small distance sensors also have a switching output and offer the possibility of defining a switching window by means of two switching points. Thanks to their easy operation, these sensors are particularly suitable for simple measurement and regulatory tasks at distances of up to 200 mm. Our laser and LED variants cover a very broad range of applications.

Key applications:

- Dancer roll regulation, sag monitoring (LED / laser)
- Determining the roll diameter of an unwinding machine (LED / laser)
- Stacking height measurement, double layer detection and height measurements in the wood processing, packaging- and handling industry (LED / laser)
- Distance measurement and positioning on robot grippers in „pick & place“ applications (LED / laser)
- Small part measurement, e.g. O-rings and electronic components (laser)
- Measurement on multicoloured and high-contrast objects, e.g. packages (laser)

FT 25-R(L)A – Product Overview			
	Operating range	Special features	Page
FT 25-RLA	20 ... 100 mm	Laser, small housing	8
FT 25-RA	20 ... 80 mm / 30 ... 200 mm	Small housing with long range	10

FT 25-RLA

Precise miniature laser distance sensor



The FT 25-RLA inspects the presence and thickness of sealing rings. The MBD F25ST2 dovetail bracket ensures easy mounting and adjustment.

TYPICAL FT 25-RLA

- Smallest laser distance sensor of its kind
- Small laser light spot for reliable measurement of small objects
- Low weight - suitable for robotic applications
- High repeatability for precise control tasks on nearly all surfaces
- Full eye safety thanks to laser class 1
- High flexibility due to large measurement ranges

Distance measurement using triangulation

The measurement principle of optical triangulation is suitable for the precise determination of distances at close range. With the help of special receiver optics and a position-sensitive detector (e.g. a photodiode line), the sensor can determine the object distance regardless of its reflectivity (see illustration below). The colour and surface properties (e.g. highly reflective) thus have practically no effect on measurement accuracy.

The FT 25-R(L)A distance sensors provide a signal proportional to the distance, transmitted via the analogue output (1 ... 10 V). Additionally, an arbitrary switching window is adjustable within the measuring range (via the teach-in button). The output of the two switching points is supplied at the digital switching output.

The triangulation process: with the help of a line-shaped position-sensitive detector; the distance sensor measures the distance to the object regardless of the amount of light reflected.

The light reflected back from the object (P_1) hits the line at point P_1' . The sensor determines the distance signal from this. The light correspondingly hits the detector at a different point (P_2) at object distance P_2 .

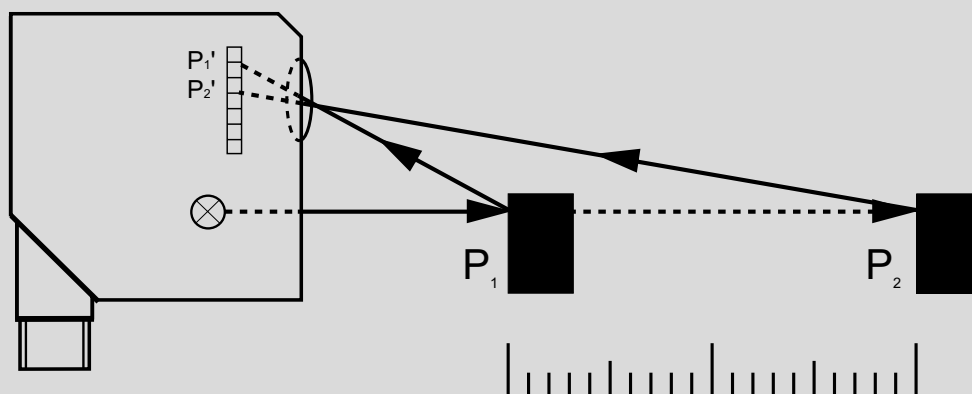



Dancer roll regulation and sag monitoring

Due to its high repeatability, the **FT 25-R(L)A distance sensor** accurately detects the change of position of the dancer roll. This ensures a precise control of the unwinding.

- Precise determination of dancer roll position for active traction force regulation of the web being wound
- Reliable detection regardless of the target object's surface properties
- Short response time for rapid processes
- Measurement ranges up to 200 mm
- Analogue and switching output for precise two-step control tasks

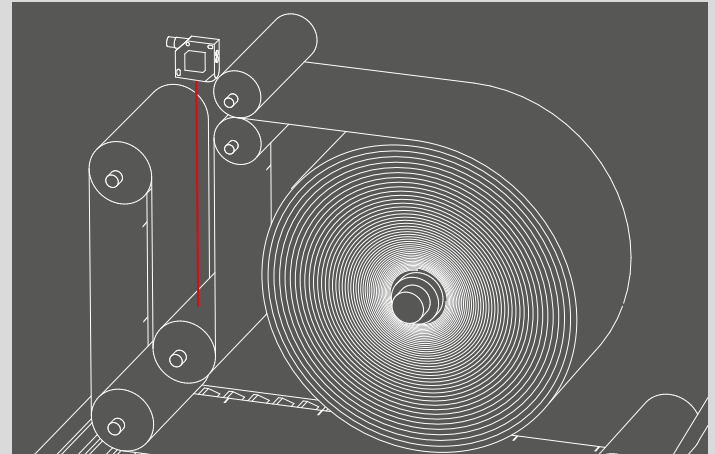

Determining the roll diameter of an unwinding machine

The **FT 25-R(L)A distance sensor** precisely determines the diameter of the unwinding machine to provide an early information for an upcoming roll change.

- Small housing for easy integration
- High accuracy regardless of target object's surface properties
- Short response time

Further key applications of the FT 25-R(L)A include:

- Stacking height measurement, double layer detection and height measurements in the wood processing, packaging- and handling industry
- Distance measurement and positioning on robot grippers at „pick & place“ applications

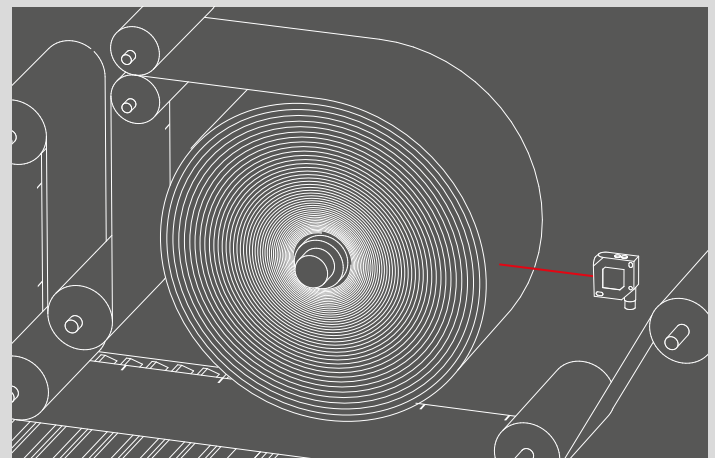

FT 25-RLA

Miniature laser distance sensor



PRODUCT HIGHLIGHTS

- Small laser light spot for reliable distance measurement of small objects part detection
- Miniature housing and low weight - suitable for robotic applications
- High linearity and high repeatability for precise control tasks
- Invertible analogue characteristic
- Window mode e.g. for two-step controls separately adjustable

Optical data		Functions	
Measurement range	20 ... 100 mm ¹	Indicator LED, green	Operating voltage indicator
Resolution	0.12 mm (12-bit)	Indicator LED, yellow	Switching output indicator
Linearity	± 0.25 mm ²	Measurement range adjustment	Via Teach-in button
Repeatability	< 0.25 mm ^{2,3}	Adjustment possibilities	Analogue measurement range Q _A
Type of light	Laser, red, 650 nm		Invertible analogue characteristic
Light spot size	See diagram		Switching output Q (window mode)
Laser class (DIN EN 60825-1:2008-5)	1		N.O. / N.C. and Auto-Detect / NPN / PNP via teach-in button
		Default settings	See Table
Electrical data		Mechanical data	
Operating voltage, +U _B	13 ... 30V DC	Dimensions	34 x 20 x 12 mm
No-load current, I ₀	≤ 30 mA	Enclosure rating	IP 67 / IP 69K ⁵
Output current, I _{e Q}	≤ 100 mA	Material, housing	ABS
Protective circuits	Reverse-polarity protection, U _B / short-circuit protection (Q)	Material, front screen	PMMA
Protection Class	2	Type of connection	See Selection Table
Power On Delay	< 300 ms	Ambient temperature: operation	-20 ... +60 °C ⁶
Switching output, Q	Auto-Detect (NPN / PNP) ⁴	Ambient temperature: storage	-20 ... +80 °C
Output function	N.O. / N.C.	Weight (metal plug device)	10 g
Max. capacitive load Q	10 nF	Resistance to vibrations and impacts	EN 60947-5-2
Switching frequency, f (ti/tp 1:1) Q	≤ 1000 Hz		
Response time Q	500 μs		
Analogue output Q _A	1 ... 10V / max. 3 mA		
Response time Q _A	3.4 ms		
Warm-up time	10 min.		
Temperature drift	< 0.1 mm/K		

¹ Reference material: 6...90 % reflectivity ² Reference material, 18 % reflectivity ³ At 6 σ, at constant ambient conditions, typ. values see diagram ⁴ Auto-Detect: Automatic selection of PNP or NPN by the sensor; PNP or NPN can be fixed ⁵ With connected IP 67 / IP 69K plug ⁶ UL: -20°C...+50 °C

Measurement range	Analogue output	Switching output	Type of connection	Part number	Article number
20 ... 100 mm	1 ... 10V	Auto-Detect	Metal plug, M8x1, 4-pin	FT 25-RLA-80-PNSU-M4M	604-41010

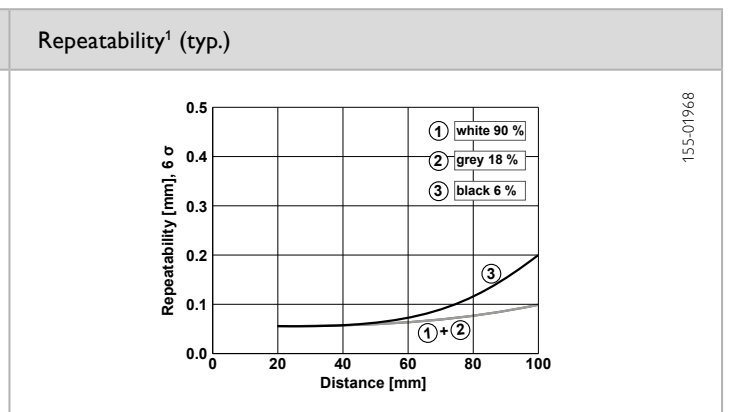
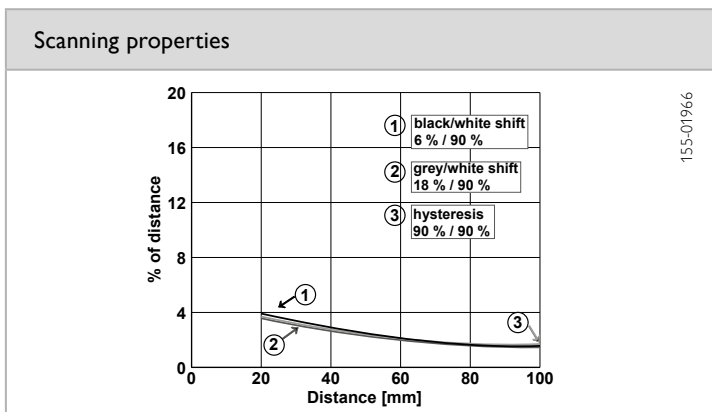
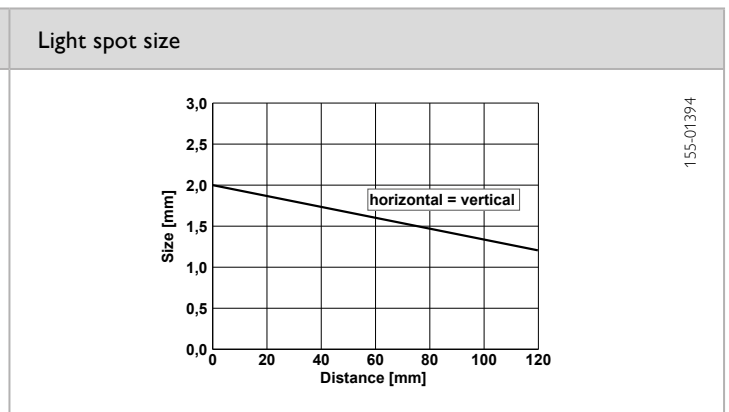
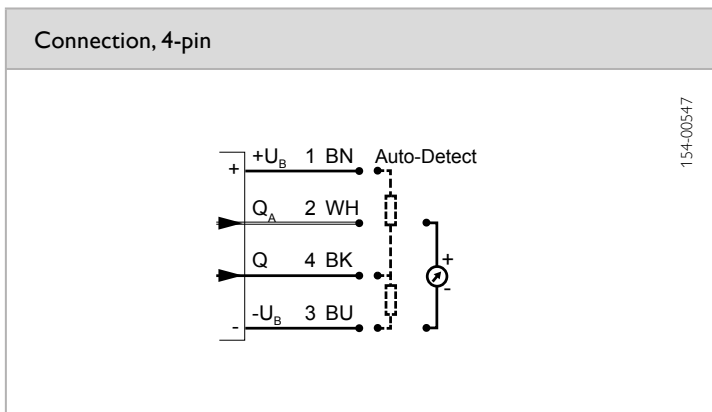
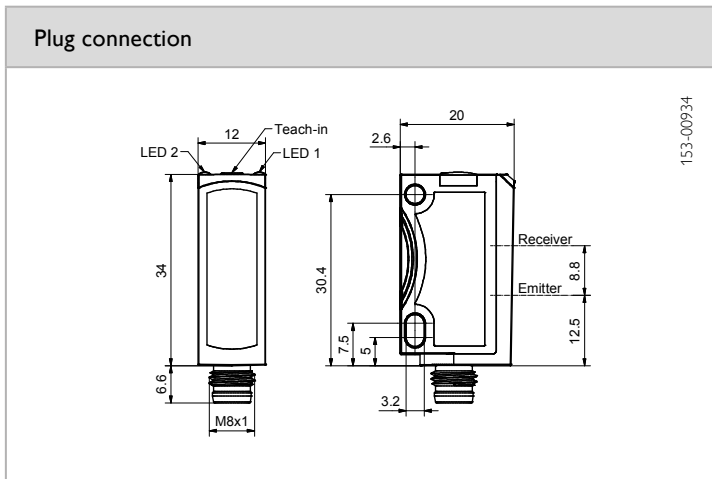

¹ At constant ambient conditions

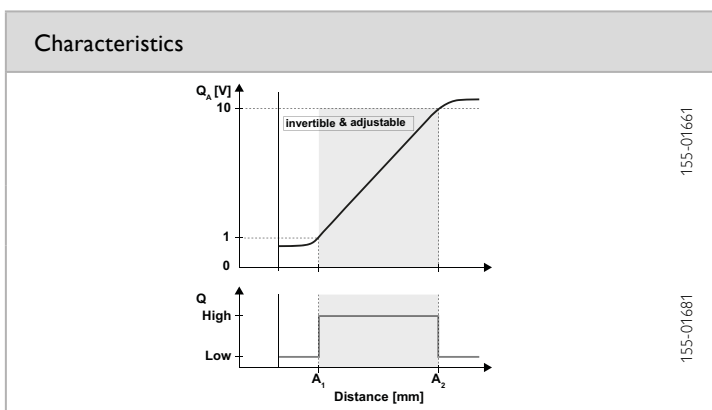

Default settings

Analogue output Q_A (1 ... 10V)	20 ... 100 mm
Switching output Q (A1 ... A2), N.O.	20 ... 100 mm

FT 25 RA

Miniature distance sensor



PRODUCT HIGHLIGHTS

- Miniature housing with measurement ranges up to 200 mm for an easy integration and high flexibility
- High linearity and high repeatability for precise control tasks
- Almost surface independent detection on homogeneous object surfaces
- Invertible analogue characteristic
- Window mode e.g. for two-step controls separately adjustable

Optical data		Functions	
Measurement range	20 ... 80 mm ¹	30 ... 200 mm ¹	Indicator LED, green
Resolution	0,12 mm	0,68 mm	Indicator LED, yellow
Linearity	± 0.4 mm ²	± 2 mm ²	Measurement range adjustment
Repeatability	< 0.4 mm ^{2,3}	< 1 mm ^{2,3}	Adjustment possibilities
Type of light	LED, red, 632 nm	LED, red, 632 nm	Default settings
			Operating voltage indicator
			Switching output indicator
			Via Teach-in button
			Analogue measurement range Q _A
			Invertible analogue characteristic
			Switching output Q (window mode)
			N.O./N.C. via teach-in button
			See Table
Electrical data		Mechanical data	
Operating voltage, +U _B	13 ... 30V DC	Dimensions	34 x 20 x 12 mm
No-load current, I ₀	≤ 30 mA	Enclosure rating	IP 67 / IP69 K ⁴
Output current, I _{e Q}	≤ 100 mA	Material, housing	ABS
Protective circuits	Reverse-polarity protection, U _B / short-circuit protection (Q)	Material, front screen	PMMA
Protection Class	2	Type of connection	(See Selection Table)
Time to readiness	< 300 ms	Ambient temperature: operation	-20 ... +60 °C ⁵
Switching output, Q	PNP/NPN (See Selection Table)	Ambient temperature: storage	-20 ... +80 °C
Output function	N.O./N.C.	Weight (plug device)	10 g
Max. capacitive load Q	10 nF	Resistance to vibrations and impacts	EN 60947-5-2
Switching frequency, f (ti/tp 1:1) Q	≤ 1000 Hz		
Response time Q	500 μs		
Analogue output Q _A	1 ... 10V / max. 3 mA		
Response time Q _A	400 μs (FT 25-RA-60)		
	3.4 μs (FT 25-RA-170)		
Warm-up time	10 min.		
Temperature drift	< 0.1 mm/K (FT 25-RA-60)		
	< 0.2 mm/K (FT 25-RA-170)		

¹ Reference material: 6...90 % reflectivity, ² Reference material grey, 18 % reflectivity, ³ at constant ambient conditions.





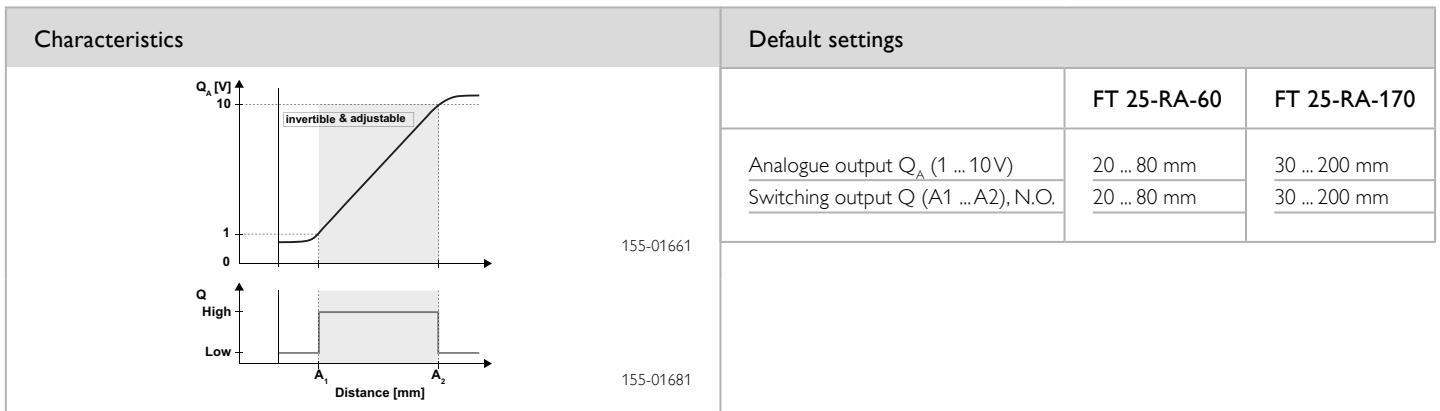
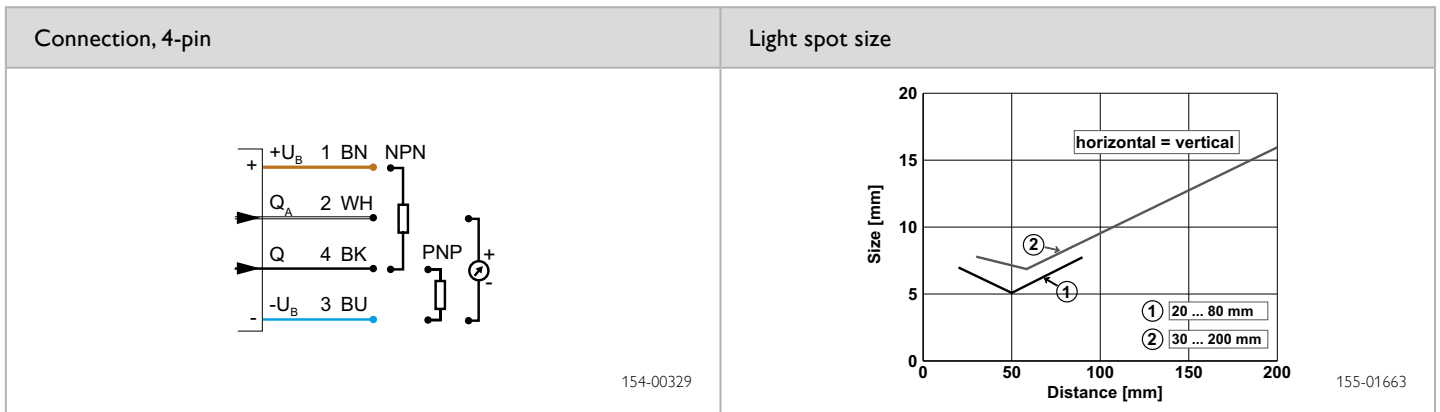
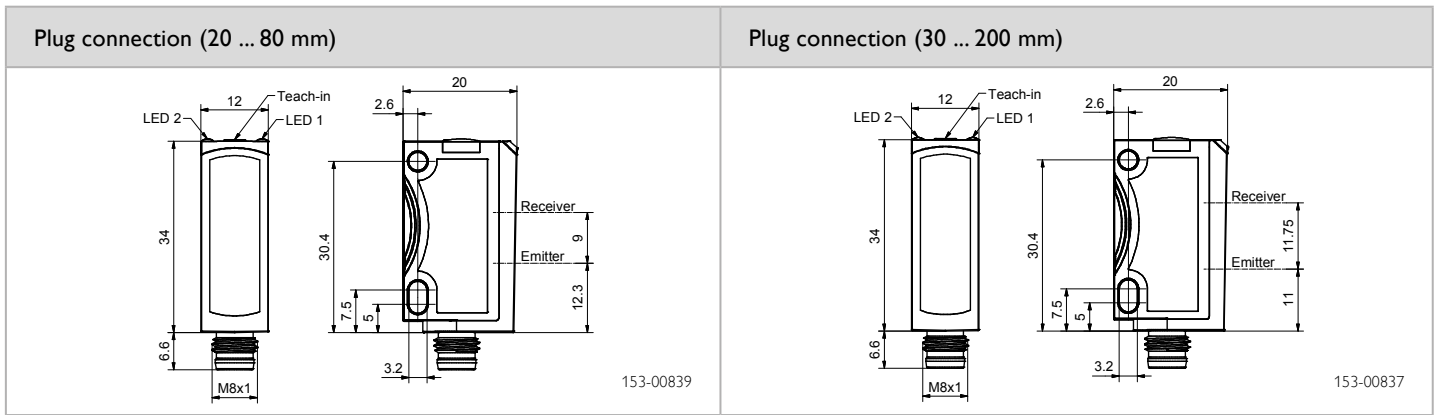



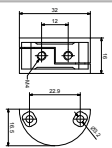
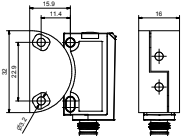

⁴ with connected IP 67 / IP 69K plug, ⁵ UL: -20°C...+50 °C

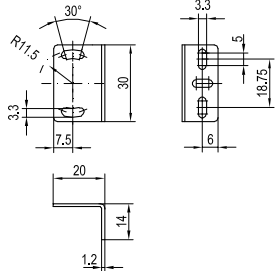

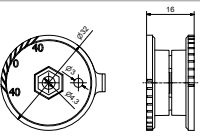
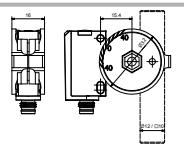

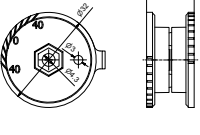
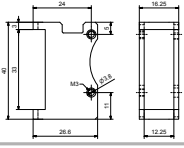

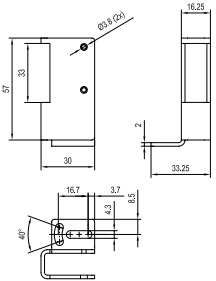

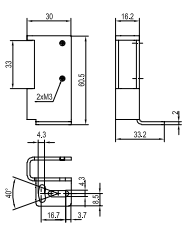

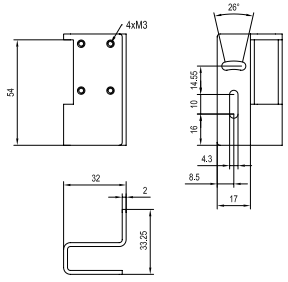
Measurement range	Analogue output	Switching output	Type of connection	Part number	Article number
20 ... 80 mm	1 ... 10V	PNP	Metal plug, M8x1, 4-pin	FT 25 RA-60-PSU-M4M	604-41000
20 ... 80 mm	1 ... 10V	NPN	Metal plug, M8x1, 4-pin	FT 25 RA-60-NSU-M4M	604-41001
30 ... 200 mm	1 ... 10V	PNP	Metal plug, M8x1, 4-pin	FT 25 RA-170-PSU-M4M	604-41002
30 ... 200 mm	1 ... 10V	NPN	Metal plug, M8x1, 4-pin	FT 25 RA-170-NSU-M4M	604-41003

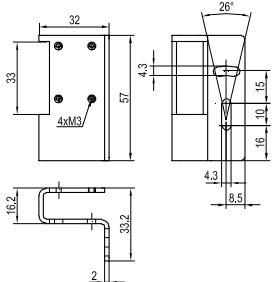

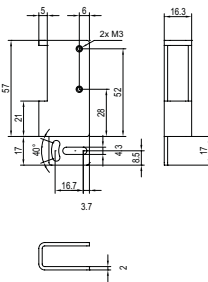
Accessories

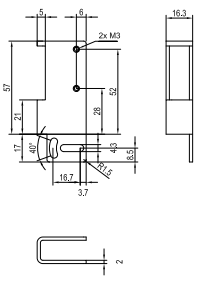
Brackets

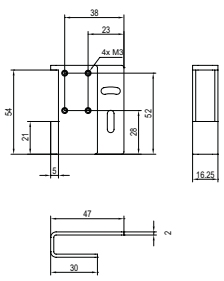
Brackets for F 25 series			
	 <p>153-00945</p>	<p>Part number / Article number</p> <p>Description</p>	<p>MBD F 25 / 661-01000</p> <p>Dovetail clamp mounting, adjustable $\pm 15^\circ$, with screws</p> <p>Material: anodised aluminium</p>
	 <p>153-00946</p>	<p>Suitable for</p>	<p>F 25</p>
	 <p>153-00241</p>	<p>Part number / Article number</p> <p>Description</p>	<p>MS F 20 / 558-41000</p> <p>Mounting bracket with screws</p> <p>1x retaining strip</p> <p>Material: nickel-plated steel</p>
	<p>Suitable for</p>	<p>F 20</p> <p>F 25</p> <p>UT 20</p> <p>FL 20</p>	
	 <p>153-01155</p>	<p>Part number / Article number</p> <p>Description</p>	<p>MBD F 25ST2 / 661-01005</p> <p>Clamping bracket for $\varnothing 12$ mm mounting rod and 10 x 10 mm square profile, with M4 screw and M3 nut</p> <p>Material: die-cast zinc</p>
	 <p>153-01156</p>	<p>Suitable for</p>	<p>F 25</p>
	 <p>153-01155</p>	<p>Part number / Article number</p> <p>Description</p>	<p>Set: MBD F 25STP / 661-01004</p> <p>Clamping bracket for $\varnothing 12$ mm mounting rod and 10 x 10 mm square profile, with protective casing, M4 screw, M4 thumbscrew, M4 nut, 2x M3 screw</p> <p>Material: die-cast zinc</p> <p>Casing Material: stainless steel V2A</p>
	 <p>153-01163</p>	<p>Suitable for</p>	<p>F 25</p>
	 <p>153-01017</p>	<p>Part number / Article number</p> <p>Description</p>	<p>MSP F 20-11 / 558-41006</p> <p>Protective sensor angle bracket with screws, very robust</p> <p>Material: stainless steel V2A</p>
	<p>Suitable for</p>	<p>F 20 UT 20-150</p> <p>F 25 UT 20-S150</p> <p>FL 20 UT 20-240</p>	
	 <p>153-00296</p>	<p>Part number / Article number</p> <p>Description</p>	<p>MSP F 20-1 / 558-41004</p> <p>Protective sensor angle bracket with screws, very robust</p> <p>Material: stainless steel V2A</p>
	<p>Suitable for</p>	<p>F 20</p> <p>F 25</p> <p>UT 20</p> <p>FL 20</p>	

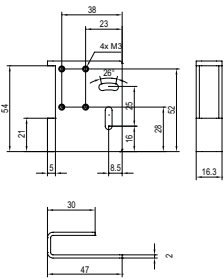
Brackets for F 25 series			
	 <p style="text-align: right;">153-00908</p>	<p>Part number / Article number</p> <p>Description</p> <p>Suitable for</p>	<p>MSP F 20-23 / 558-41011</p> <p>Protective sensor angle bracket with screws, very robust Material: stainless steel V2A</p> <p>F 20 F 25 UT 20 FL 20</p>
	 <p style="text-align: right;">153-00297</p>	<p>Part number / Article number</p> <p>Description</p> <p>Suitable for</p>	<p>MSP F 20-2 / 558-41005</p> <p>Protective sensor angle bracket with screws, very robust Material: stainless steel V2A</p> <p>F 20 UT 20-150 F 25 UT 20-S150 FL 20 UT 20-240</p>
	 <p style="text-align: right;">153-00973</p>	<p>Part number / Article number</p> <p>Description</p> <p>Suitable for</p>	<p>MSP F 20-13 / 558-41008</p> <p>Protective sensor angle bracket with screws, very robust Material: stainless steel V2A</p> <p>F 20 UT 20-150 F 25 UT 20-S150 FL 20 UT 20-240</p>
	 <p style="text-align: right;">153-00972</p>	<p>Part number / Article number</p> <p>Description</p> <p>Suitable for</p>	<p>MSP F 20-12 / 558-41007</p> <p>Protective sensor angle bracket with screws, very robust Material: stainless steel V2A</p> <p>F 20 UT 20-150 F 25 UT 20-S150 FL 20 UT 20-240</p>
	 <p style="text-align: right;">153-00974</p>	<p>Part number / Article number</p> <p>Description</p> <p>Suitable for</p>	<p>MSP F 20-21 / 558-41009</p> <p>Protective sensor angle bracket with screws, very robust Material: stainless steel V2A</p> <p>F 20 UT 20-150 F 25 UT 20-S150 FL 20 UT 20-240</p>
	 <p style="text-align: right;">153-00975</p>	<p>Part number / Article number</p> <p>Description</p> <p>Suitable for</p>	<p>MSP F 20-22 / 558-41010</p> <p>Protective sensor angle bracket with screws, very robust Material: stainless steel V2A</p> <p>F 20 UT 20-150 F 25 UT 20-S150 FL 20 UT 20-240</p>

Accessories

Cables



Part number	Article number	Description
M8, 4-pin		
K4-2m-G-PUR	902-50801	2 m, straight, PUR, suitable for drag chains
K4-5m-G-PUR	902-51617	5 m, straight, PUR, suitable for drag chains
K4-10m-G-PUR	902-51610	10 m, straight, PUR, suitable for drag chains
K4-2m-W-PUR	902-50803	2 m, 90°, PUR, suitable for drag chains
K4-5m-W-PUR	902-51618	5 m, 90°, PUR, suitable for drag chains
K4-10m-W-PUR	902-51629	10 m, 90°, PUR, suitable for drag chains
K4-2m-W-PL-PUR	902-51642	2 m, 90°, PUR, with indicator LED
K4-5m-W-PL-PUR	902-51643	5 m, 90°, PUR, with indicator LED
CM4 FG-E-5m-PVC	902-50221	5 m, straight, PVC, with hex nut SW 9 stainless steel (IP 69K), suitable for drag chains
CM4 FW-E-5m-PVC	902-50222	5 m, 90°, PVC, with hex nut SW 9 stainless steel (IP 69K), suitable for drag chains



>> To the digital catalogue

You can very easily call up this catalogue with your smart phone – using the code opposite.

Sensors



VISOR®

*SensoPart sets new standards for industrial sensors with the optoelectronic sensors of the **F 10**, **F 25** and **F 55** series: all three housing sizes share excellent optical performance data, very precisely adjustable background suppression, intuitive and comfortable operation, and excellent quality – made in Germany. And our application-specific pre-configured – and thus immediately usable – all-in-one solutions in the **VISOR®** series show what is now possible in the vision segment.*

We look ahead.

Yesterday, today and in the future.

 **SENSOPART**



“We gauge ourselves not by what is possible today, but by our vision of what can be achieved” – this has been our motto since the foundation of Sensopart in 1994. Our goal is to always be a step ahead and to be able to offer our customers the most innovative sensor for industrial automation.

With our easy to integrate VISOR® Vision sensors and our compact laser sensors with an amazing background suppression made in Germany, we stick up to this motto.

Get ready – we still have a lot of ideas for the future.

SENSOR TECHNOLOGY

- Light barriers
- Proximity switches
- Laser sensors
- Miniature sensors
- Distance sensors
- Colour sensors
- Contrast sensors
- Anti-collision sensors
- Slot sensors
- Fibre-optic amplifiers
- Inductive sensors
- Capacitive sensors
- Ultrasonic sensors

VISION

- Vision sensors
- Smart cameras
- Vision systems
- Object detection
- Object measurement
- Colour detection
- Code reading
- Lighting
- Lenses

Sold & Serviced By:



Canadian and International Sales

ELECTROMATE

877-737-8698

sales@electromate.com

www.electromate.com

U.S. Sales

SERVO2GO.com

877-378-0240

sales@servo2go.com

www.servo2go.com