



## P7000 Selection Guide

# P7000 Microstepping Drives



*Helping you build a better machine, faster.*



*Helping you build a better machine, faster.*

## Danaher Motion -

Helping you build a better machine, faster

Danaher Corporation combined over 30 industry-leading brands such as Kollmorgen, Thomson, Dover, Pacific Scientific, Portescap, Neff, Seidel and Bautz to establish a customer-focused motion control manufacturing company called Danaher Motion. We offer this powerful set of integrated motion control technologies under the Danaher Motion and Thomson brand names. We are a \$1B+ global motion control leader, unique in our ability to marshal decades of application experience and technical innovation to help you build better machines, faster.

Danaher Motion defines high standards of quality, innovation and technology. We enable improved machine performance and reliability while controlling costs. Our global manufacturing footprint, rapid customization and prototyping capabilities drive quick lead times. Unmatched application experience and design expertise empowers you to commission machines faster.

Consider your options in today's market for a motion control partner. Select Danaher Motion and join a team with over 6000 employees, over 60 years of application experience and 2000+ distributor locations around the globe. Danaher Motion serves industries as diverse as semiconductor, aerospace and defense, electric vehicle systems, packaging, printing, medical and robotics. We offer an unparalleled depth and breadth of motion control product solutions through a worldwide service and support infrastructure, field service engineers and support teams available when and where you need them.

## The Danaher Business System -

Building sustainable competitive advantage into your business

The Danaher Business System (DBS) was established to increase the value we bring to customers. It is a mature and successful set of tools we use daily to continually improve manufacturing operations and product development processes. DBS is based on the principles of Kaizen which continuously and aggressively eliminate waste in every aspect of our business. DBS focuses the entire organization on achieving breakthrough results that create competitive advantages in quality, delivery and performance – advantages that are passed on to you. Through these advantages Danaher Motion is able to provide you faster times to market as well as unsurpassed product selection, service, reliability and productivity.

## Local Support Around the Globe



## New Name, Established Brands

Danaher Motion's wide range of motion control systems and components offer customers an unprecedented choice in selecting the right solution for their particular application requirements. Our product innovations have been improving the efficiency and productivity of complex manufacturing operations for over 60 years in industries as diverse as semiconductor, aerospace and defense, mobile-off-highway, packaging, medical and robotics.

Danaher Motion's growing family of leading motion control products tells only half the story. With a worldwide service and support infrastructure, our field service engineers and support teams are available when you need them. It is part of the Danaher Corporation's unrelenting focus on you, our customer. That's why more and more design engineers are turning to Danaher Motion to meet their motion control requirements.



## P7000 Drives and Step Motors - Choices without compromise.

Our new P7000 Stepper Drives and motors provide you servo-like system performance with the cost and simplicity of a stepper solution. System selection couldn't be easier. Choose from a select set of optimized motor drive combinations with the wide range of standard motor features you come to expect.

Looking for a little more performance?

The P7000 Stepper Drive bring you a unique level of system smoothness, functionality, high-speed performance and innovation unmatched in the industry.

## Continuous Improvement – It's the Danaher Way

At Danaher, we are passionate about continually improving our operations to bring increasing value to our customers. The Danaher Business System (DBS) helps us improve the efficiency of our manufacturing and product development processes. DBS is a team-based approach based on the principles of Kaizen that lets us continuously and aggressively eliminate waste in every aspect of our business operations. The DBS focuses our entire organization on achieving breakthrough results that create competitive advantage in quality, delivery and performance – advantages that we pass on to you, our customer.

Whatever your motion control requirements may be, Danaher Motion has a solution that is right for you. Our unsurpassed product selection and service means faster time to market, higher reliability and increased productivity. Let the experts at Danaher Motion put a world of motion control solutions at your fingertips.

Helping you build a better machine, *faster*.

## P7000 Introduction

# P7000 Stepper Drives

Danaher Motion introduces the P7000 Series Stepper Drives. Previously unheard of stepper features allow the P7000 to provide true servo-like performance at a fraction of the cost.

The P7000 Stepper Drives are the next generation of Danaher Motion's line of digital step motor controls. They bring you a unique level of system smoothness, functionality, high-speed performance and innovation unmatched in the industry.

Available for AC and DC operation, the compact P7000 is designed to power Danaher Motion step motors with appropriate electrical characteristics (see page 5). The AC drive has an input voltage of 120 or 240 Vac and the P7000 DC drive is rated for 20-75 Vdc. Its unique features make it an ideal solution for single or multi-axis applications that require high-speed performance or low speed smoothness.

Like all of Danaher Motion's step motor drives the P7000 series includes optically isolated step and direction inputs. The drives are configured by either on-board switches, or via the P7000 Tools. A full line of standard stepper motors can be set up with the on-board switches. P7000 Tools is also perfect with standard Pacific Scientific stepper motors and alternative motor types or ones with a unique winding. There are a number of advanced features offered in the P7000 systems making it the best choice to meet your application requirements.

- Motor Stall Detection without feedback for use with selected step motors
- Multistep™ translates coarse input steps to smooth output micro-steps to the stepper motor
- Motor Wave Shape Tuning for ultra smooth low speed operation
- Mid-Band Anti-Resonance Control
- Idle Current Adjustment
- Optional Indexer (-PN model)
- Optional Modbus Communications (-R4 model)



## P7000 Stepper Drives (cont'd)

### Stall Detection

Detects a stalled motor without the use of expensive external sensors or feedback. Reduces system cost by up to 30%.

### Multistep™

Also known as auto-smoothing. The P7000 drive accepts full step pulse commands from the indexer and inserts fine micro-steps to smooth coarse low speed motion. This allows you to significantly upgrade machine performance without having to redesign machine control architecture.

### Auto-Tuning

Advanced current auto-tuning techniques provide outstanding low-speed smoothness. The P7000 senses the motor's characteristics and automatically fine tunes itself to meet your high-performance needs. This reduces installation and set-up time.

### Mid-Band Anti-Resonance Control

Reduces negative effects of mechanical resonance, allowing you to get more out of a smaller motor and virtually eliminating nuisance stalls and machine downtime.

### Current Reduction

If you do not require the motor's full torque to hold a load at rest, you can select the right amount of current (torque) to reduce motor heating and power consumption. This increases the life of the system.

### Dynamic Smoothing

Quasi-S-curve algorithm reduces jerk, especially upon acceleration. Increases mechanical life of machine and reduces energy consumption.

### Intelligent Indexing Option (-PN)

Wizard-like P7000 helps you to develop and link motion tasks such as homing and conditional and unconditional indexing. You can be up-and-running quickly.

### Modbus RTU Compatible

The Intelligent Indexing option (-PN) supports ModBus RTU to control motion with an external interface device. External interfaces make controlling motion simple for machine operators.

### P7000 Tools

The position node option allows you to configure up to 63 absolute or relative moves. You can specify the moves' distance, acceleration, velocity, and deceleration rates, or simply specify the distance and total time for the move – P7000 will perform the calculations automatically.

## Features and Benefits

- Open Loop Stall Detect (OLSD) allows detection of stalled motor without the need of expensive external sensors or feedback. Saves up to 30% of system cost.
- Multi-Stepping™ allows low-resolution full step input pulses to be converted to smooth micro stepping commands increasing low-speed performance of your machine.
- Dynamic Smoothing™ rounds the edges of the move profile (Quasi-S curve). Minimizes jerk during acceleration increasing the mechanical life of your machine.
- Xtreme Smoothing™ eliminates the effects of the motor's natural resonance frequencies. Provides more usable torque throughout the speed range. Get more from a smaller motor instead of spending extra money on an over-sized motor.
- Anti-Resonance feature provides optimum torque and nulls midrange instability.
- Programmable jog function with dual speed settings.
- Step and Direction (-SD) mode and optional Indexing (-PN) available. Indexing mode allows 63 independent moves.
- Current reduction modes with programmable time and reduction amount increases motor life and decreases machine downtime.

## P7000 Features

# Features and Benefits (cont'd)

- Nine programmable inputs allow Jog+, Jog-, Jog Speed, End-of-Travel (EOT+, EOT-), Move Select, Soft Reset, Start Move, Start/Stop Move, Stop Move, On Edge and Home.
- Fault Output and one user-configurable output 5-24 VDC.
- All I/O user configurable to active high or active low operation 5-24 VDC.
- Compact size reduces panel space.
- Agency approvals UL recognized 508C, type R file #E137798, CE compliant, EMC standard EN61800-3 and safety EN50178.
- Flash Firmware for field upgrades.
- Diagnostic LEDs provide easy drive diagnostics.
- RS232 Standard (Both P70360 and P70530).
- RS485 ModBus RTU (slave) Option (P70360 Only) -R4 option.
- Configurable software for custom applications.

Specifications	Units	P70530	P70360
Input Voltage Range	Volts	20 - 75 VDC	120 or 240 VAC
Continuous Current	Amps rms	5	2.5
Microstep Peak Current	Amps peak	7.1	3.5
Dedicated Inputs*	-	+/-Enable, +/- Step & Dir* 5 VDC TTL	+/-Enable, +/- Step & Dir* 5 VDC TTL
Programmable Inputs*	-	9 Configurable, Optically Isolated* 5-24 VDC Sinking or Sourcing	9 Configurable, Optically Isolated* 5-24 VDC Sinking or Sourcing
Fault Output, user-configurable output	-	Open collector 5-24 VDC	Open collector 5-24 VDC
Idle Current Reduction	Integer	Settable 0-100%	Settable 0-100%
Step Resolution	-	200-50000 steps/rev	200-50000 steps/rev
Package Size	W x D x H Inches (mm)	1.14 x 4.4 x 4.2 (29 x 111 x 107)	2.06 x 5.2 x 6.7 (52.3 x 132 x 170)
Ambient Temperature	Degrees C	0-45	0-45
Max Chassis Temperature	Degrees C	70	70
Motor Frames	-	Nema 17, 23, 34, 42	Nema 23, 34, 42
Max Shaft Power	Watts	300	525
Speed Range	Revs/Second	0-50	0-50
Recommended Motor Inductance Range	mH	2-15	50-200 (320 VDC BUS) 7-30 (160 VDC BUS)

\* Step and Direction inputs need current limiting resistor over 5 V, the Enable does not See Reference Guide and Installation Guide for details.



P7000 DC Modular Drives - P70530

# Danaher Motion P70530 Microstepping drives are... Modular, Functional and Flexible

### Modular

The Danaher Motion P70530 DC stepper drive is modular to support a broad range of requirements. Its compact bookshelf style footprint is ideally suited for multi axis applications. It's common to use a single power supply as the source for multiple drives.

### Functional and Flexible

The drive is designed to power 2-phase NEMA 17–42 frame motors with appropriate electrical characteristics (see pg. 5). Regardless of brand, it can be configured to get the optimum power out of the motor. With a wide input voltage range of 20-75 VDC the P70530 is ideally suited to meet your application requirements.

The drive can be set up using on-board selector switches or via the software utility provided, P7000Tools. Current settings, Auto-Smoothing, Motor Wave Shaping, Mid-Band Anti-Resonance and current reduction are all selected through the switch settings. P7000Tools includes a Graphical User Interface to allow set-up for custom windings, third party motors, fine tuning and system archive and duplication.

The P70530 is offered in two standard versions. The P70530-SD is designed with a conventional step and direction interface. Dedicated inputs are available for Jog+/-, enable and Step/direction control. The user provides the pulse train to rotate the motor. The P70530-PN adds a position node indexing capability to the base drive. This allows the user to program up to 63 independent moves.



Agency Approval  
CUL, CE



## P70530 Outline/Dimensions [mm (in.)]

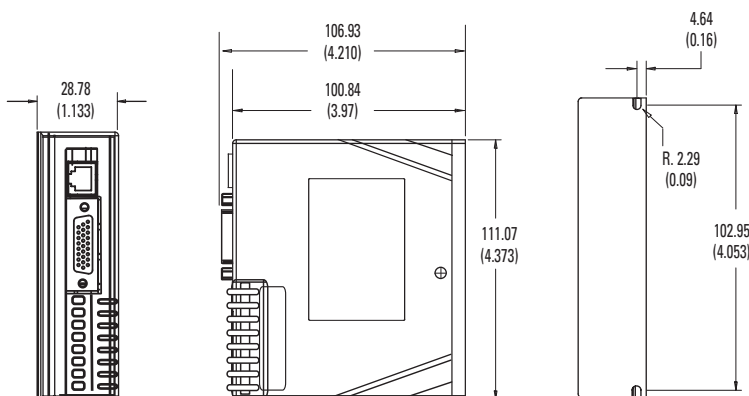

# P70530 Wiring Diagram

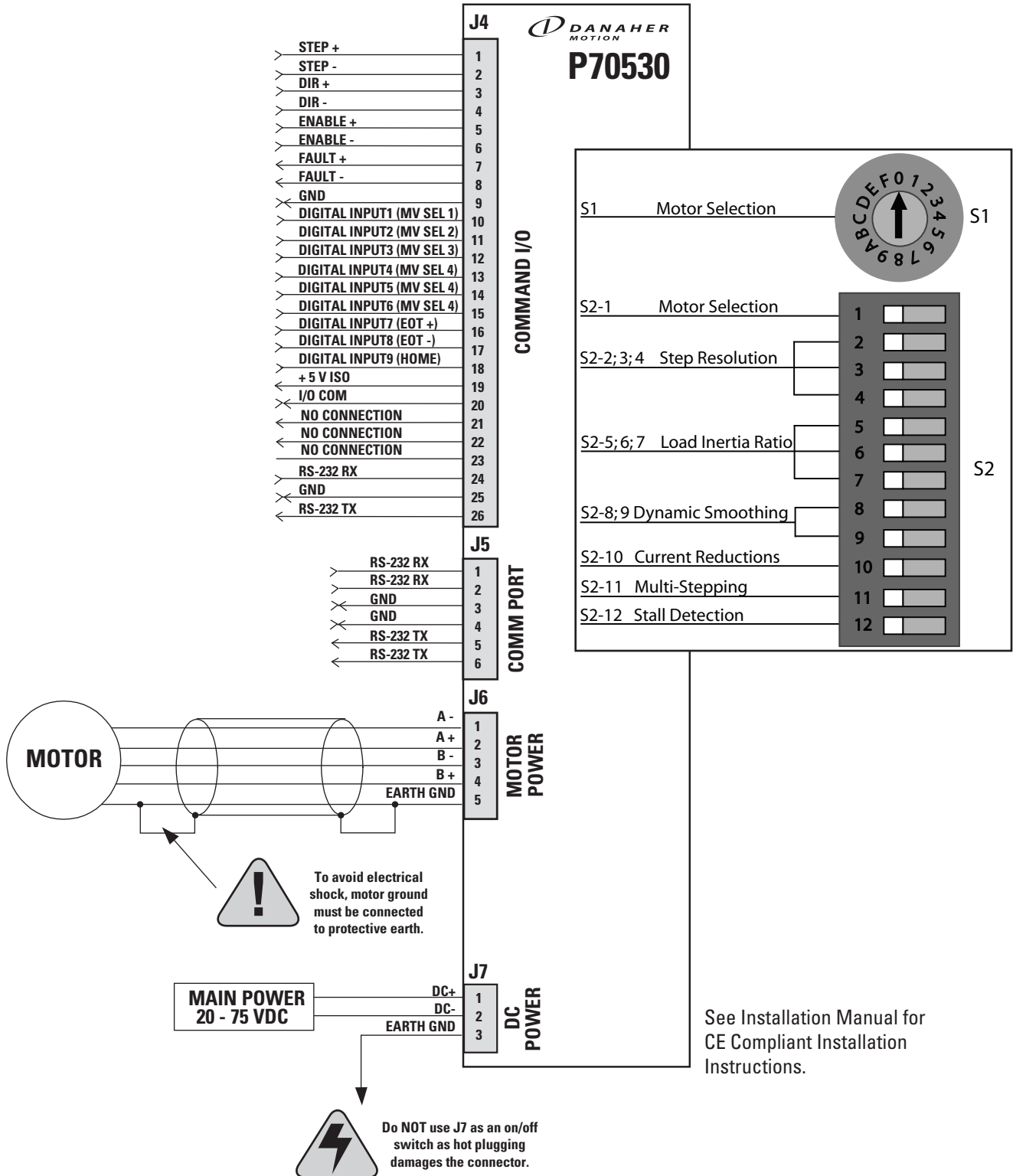



P7000 AC Packaged Drives - P70360

# Danaher Motion P70360 Microstepping drives are... Packaged, Functional and Flexible

### Packaged

The Danaher Motion P70360 AC stepper drive is a packaged drive including an integral power supply. The P70360 AC step drive is compact yet loaded with power. With a standard input voltage of 120 or 240 VAC, this product is a perfect choice to apply anywhere throughout the world.

### Functional and Flexible

The drive is designed to power 2-phase NEMA 23-42 frame motors with appropriate electrical characteristics (see page 5). Regardless of brand, it can be configured to get the optimum power out of the motor. The P70360 accepts either a 120 or 240 VAC single-phase power source in the same package.

The drive can be set up using on-board selector switches or via the software utility provided, P7000Tools. Current settings, Auto-Smoothing, Motor Wave Shaping, Mid-Band Anti-Resonance and current reduction are all selected through the switch settings. P7000Tools includes a Graphical User Interface to allow set-up for custom windings, third party motors, fine tuning and system archive and duplication.

The P70360 is offered in three standard versions. The P70360-SD is designed with a conventional step and direction interface. Dedicated inputs are available for Jog+/-, enable and Step/direction control. The user provides the pulse train to rotate the motor. The P70360-PN adds a position node indexing capability to the base drive. This allows the user to program up to 63 independent moves. The P70360-R4 adds ModBus RTU (slave) capability which supports the use of an external interface device.



Agency Approval  
CUL, CE



## P70360 Outline/Dimensions [mm (in.)]

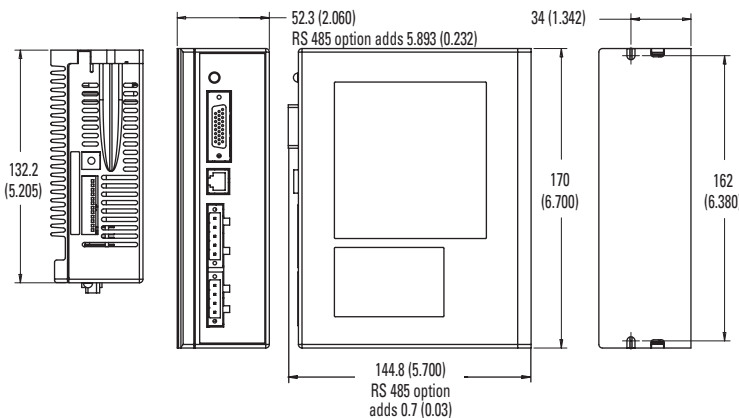

# P70360 Wiring Diagram

See Installation Manual for CE Compliant Installation Instructions.

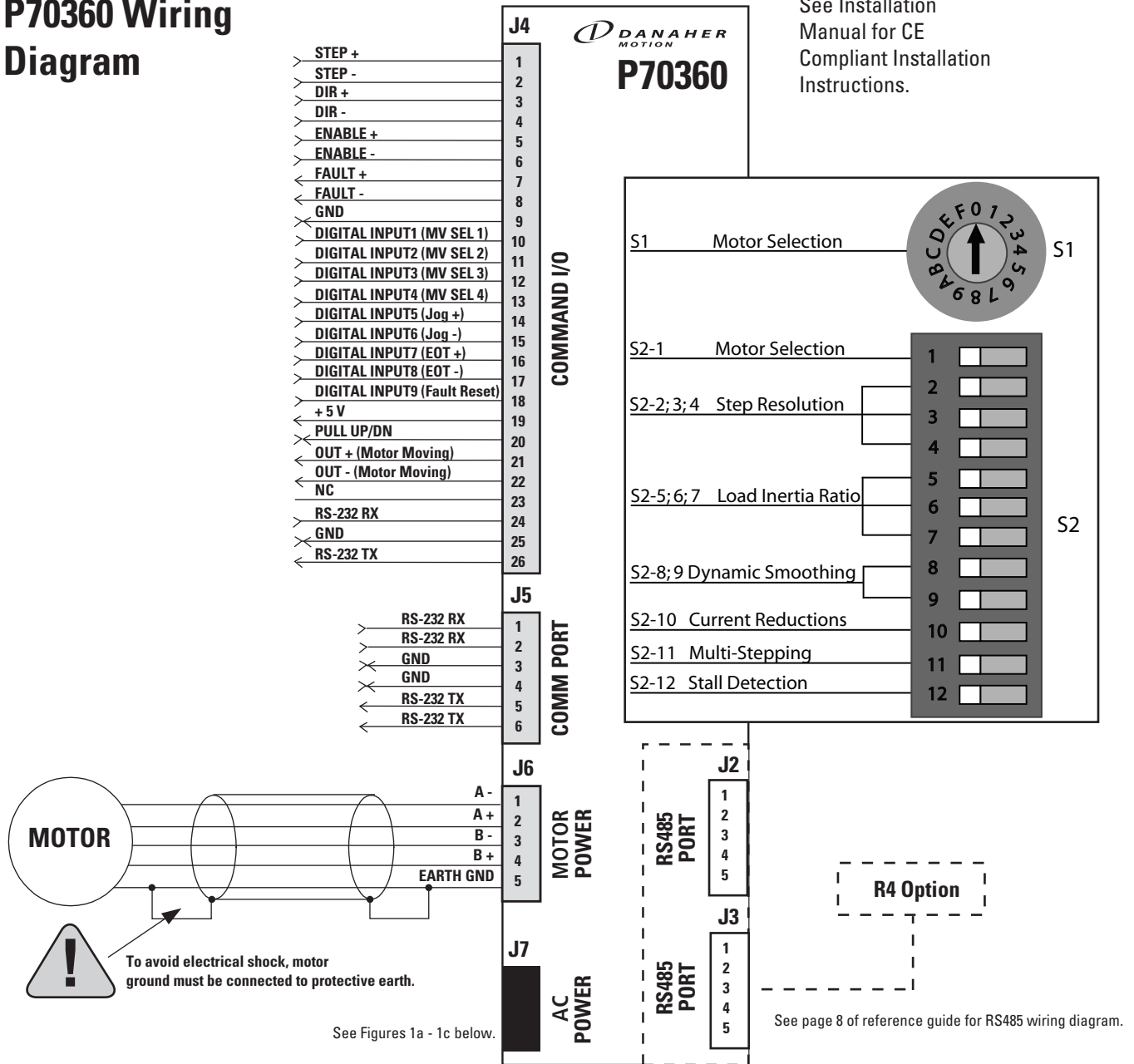

Figure 1a: Connection for a 320 VDC bus using 240 VAC.

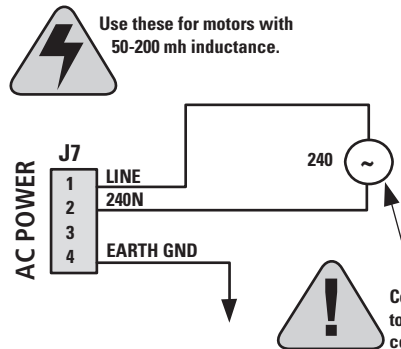

Figure 1b: Connection for a 320 VDC bus using 120 VAC.

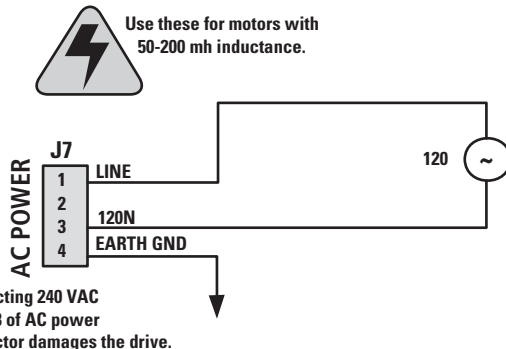
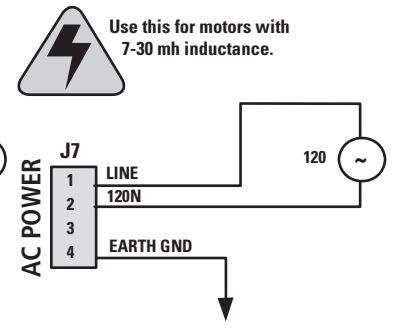

Figure 1c: Connection for a 160 VDC bus.



# P7000Tools

Our P7000Tools utility makes it easy to get your system up and running. In fact, we believe it is so intuitive that you don't even need a manual. Just run the software and the Set Up Wizard will help you along.

## P7000 Set Up Wizard

The wizard quickly guides you through the mechanical configuration, drive mode, I/O settings, and indexing programs (-PN).

- First you select the drive type.

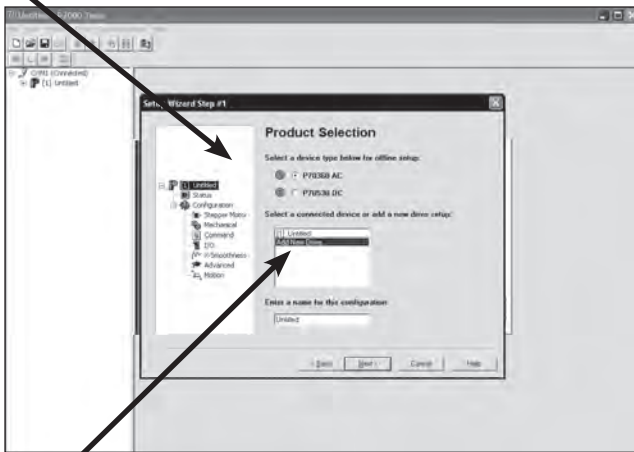

- Click on "Add New Drive" to select drive model.

- Then select your motor.

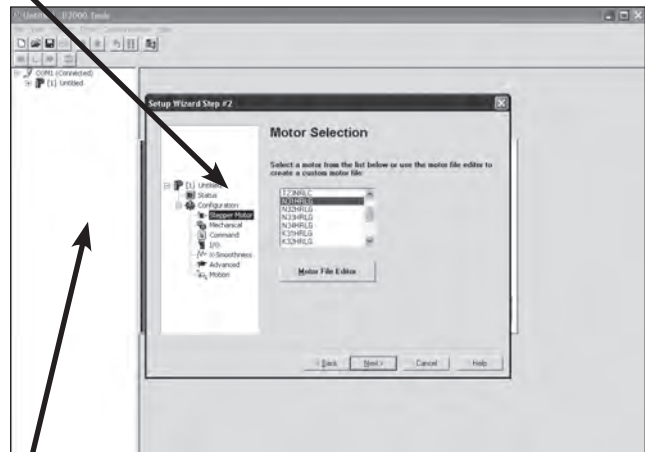

- The cursor highlights the subfolder being updated.

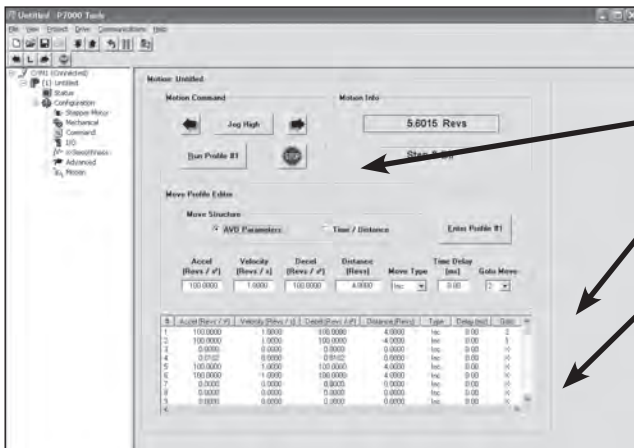

### P7000 Tools Makes Complex Set-Up/Programming Very Straight Forward

- Jog the motor with a click of your mouse.
- Simple moves can be chained together to form complex motion.
- Program up to 63 discrete move profiles.

## Step Motor Outline Dimensions

### T-SERIES NEMA 23 HIGH TORQUE MOTORS

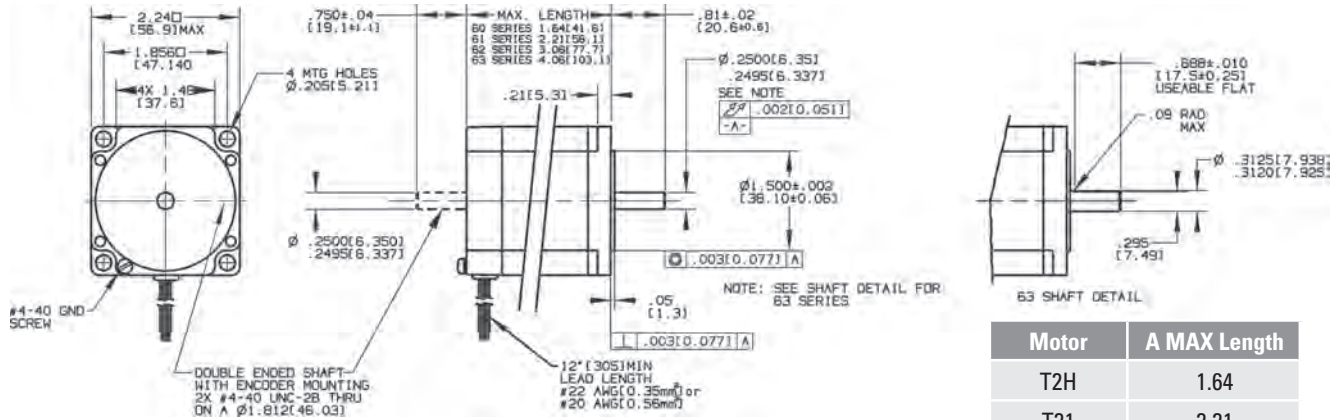

Motor	A MAX Length
T2H	1.64
T21	2.21
T22	3.06
T23	4.06

### K SERIES NEMA 34 HIGH TORQUE MOTORS

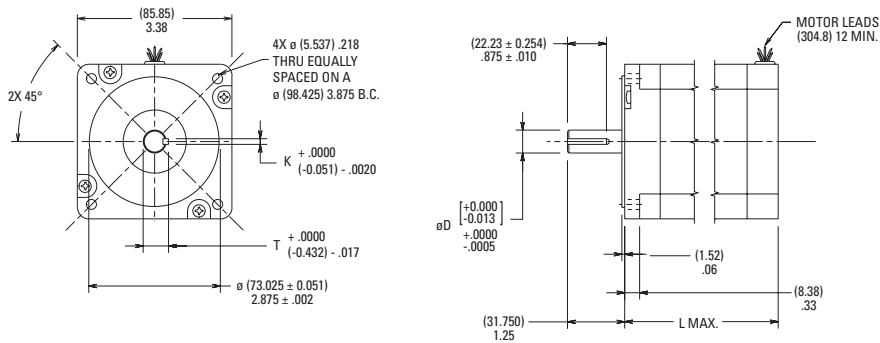

Motor	D	K	T	L MAX
31HR	0.5	0.125	0.555	3.13
32HR	0.5	0.125	0.555	4.65
33HR	0.625	0.1875	0.705	6.17
34HR	0.625	0.1875	0.705	7.68

### K SERIES NEMA 42 HIGH TORQUE MOTORS

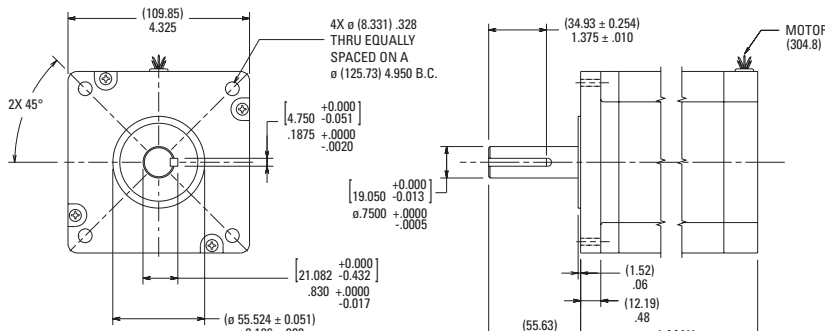

Motor	L MAX Length
41HR	5.2
42HR	7.22

Step Motor Outline Dimensions

CT-SERIES NEMA 17 HIGH TORQUE MOTORS

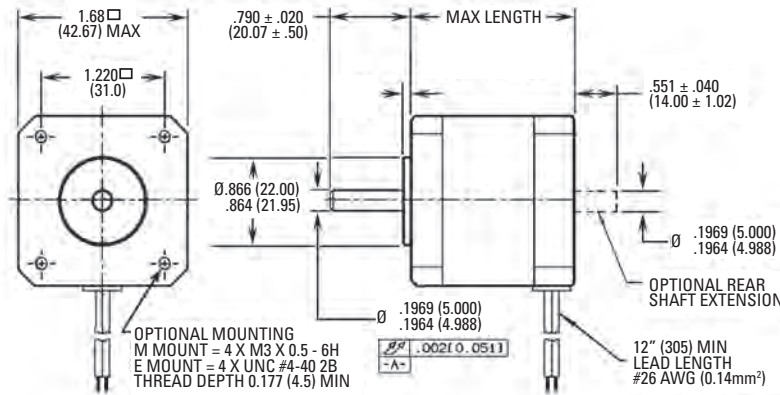

Motor	MAX Length
CT10	1.37
CT11	1.61
CT12	1.92

CT-SERIES NEMA 23 HIGH TORQUE MOTORS

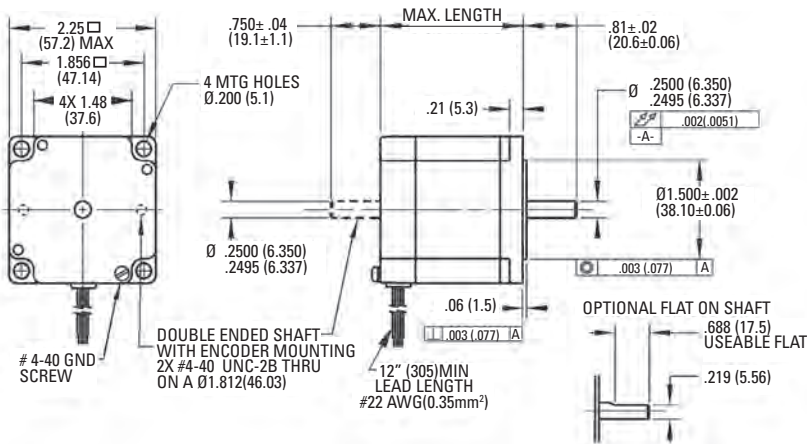

Motor	MAX Length
CT20	1.62
CT21	2.13
CT22	3.32

CT-SERIES NEMA 34 HIGH TORQUE MOTORS

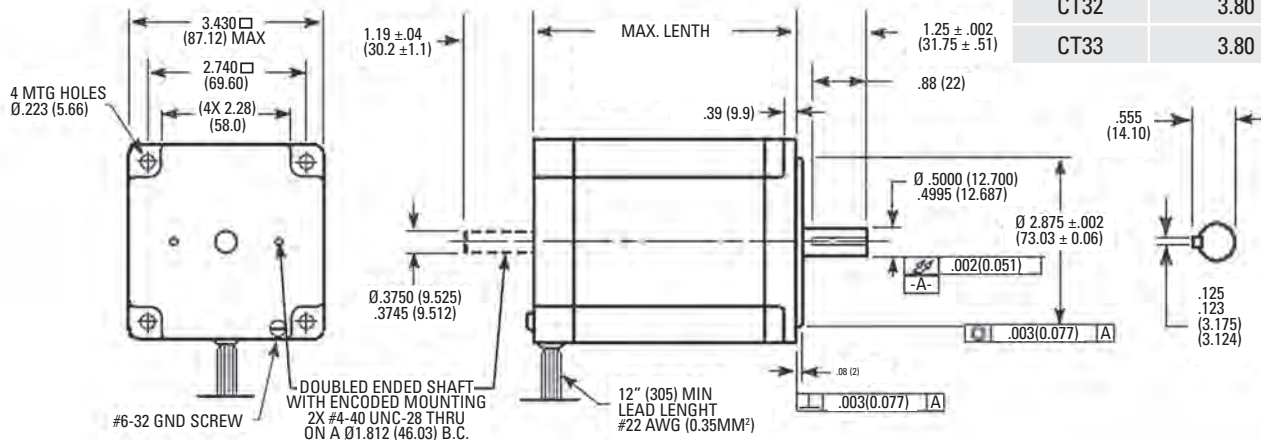

Motor	MAX Length
CT31	2.54
CT32	3.80
CT33	3.80

## DC System Performance Curves

# Nema 17 - CT Series

Below are speed-torque curves for the most popular Danaher Motion motors. Many additional motors and variants are available. Contact Danaher Motion for details.

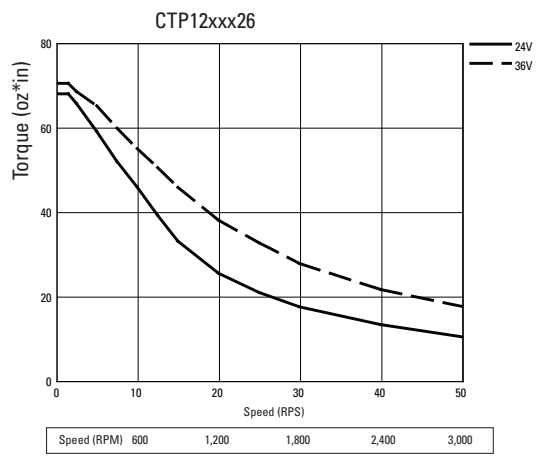
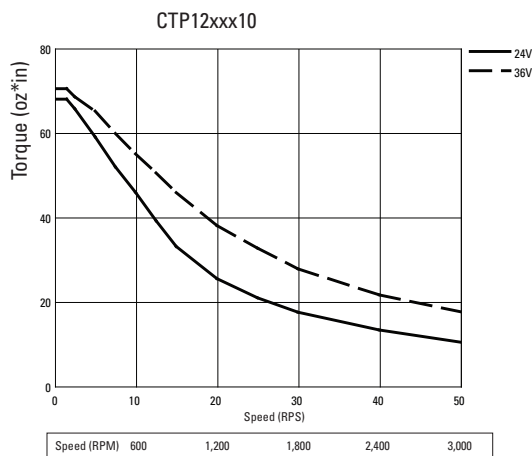
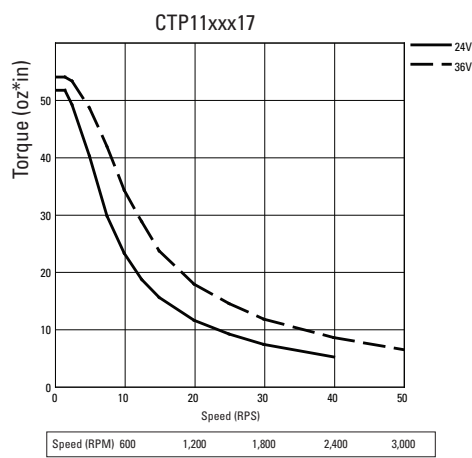
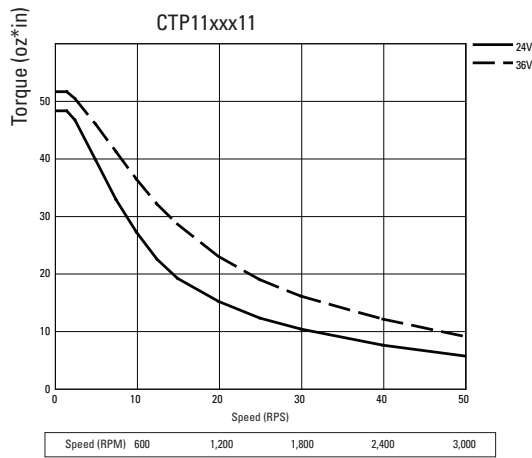
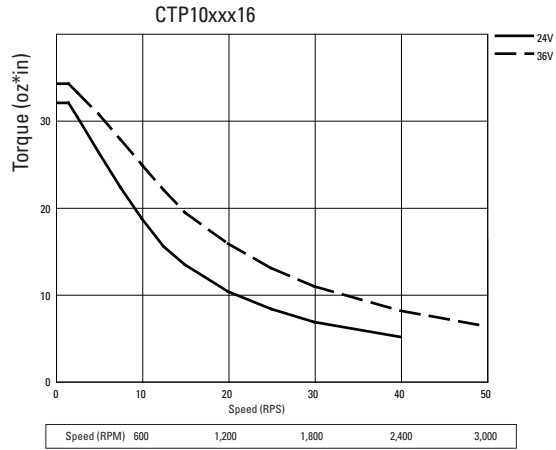
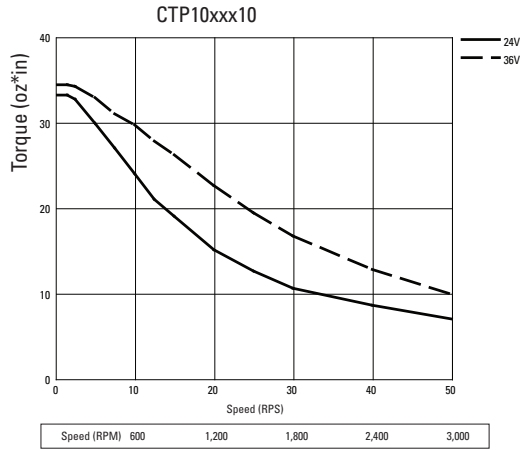



DC System Performance Curves

# Nema 23 - CT Series

Below are speed-torque curves for the most popular Danaher Motion motors. Many additional motors and variants are available. Contact Danaher Motion for details.

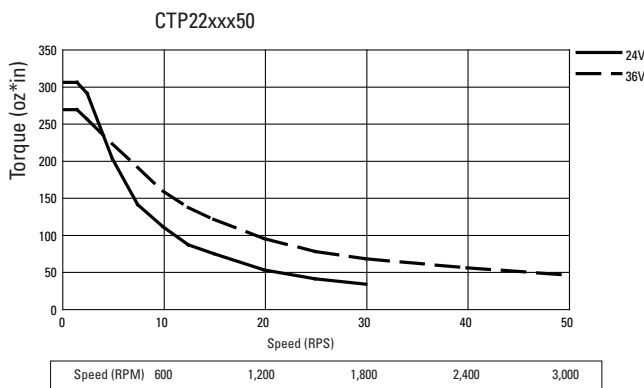
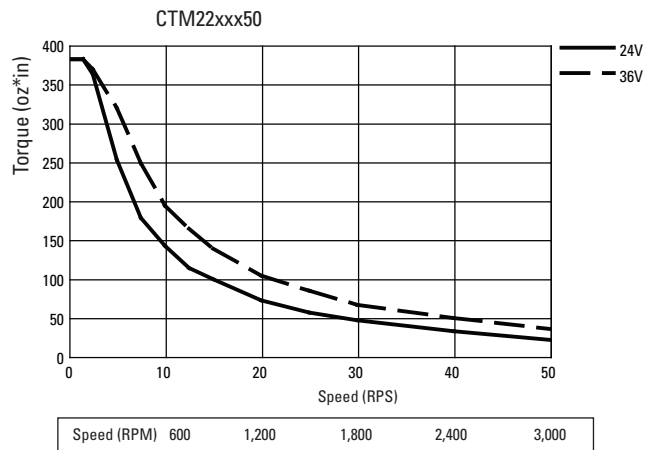
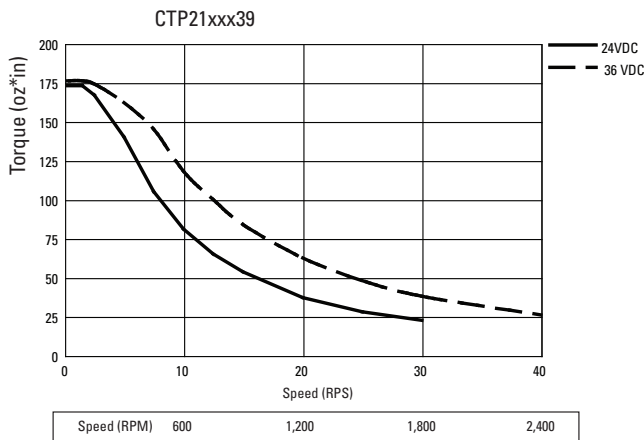
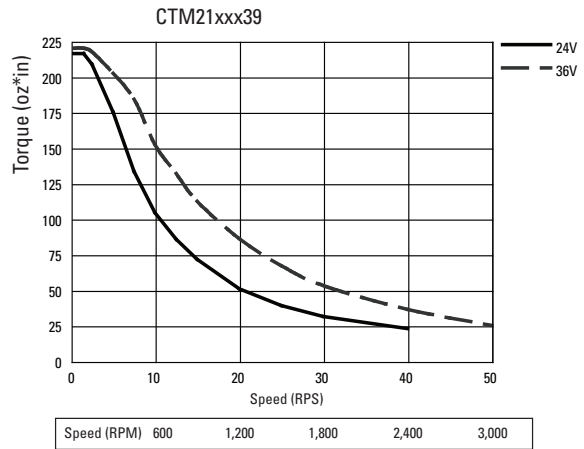
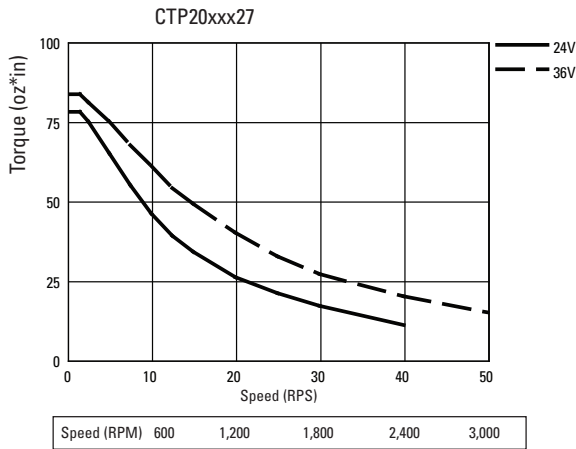

## DC System Performance Curves

# Nema 34 - CT Series

Below are speed-torque curves for the most popular Danaher Motion motors. Many additional motors and variants are available. Contact Danaher Motion for details.

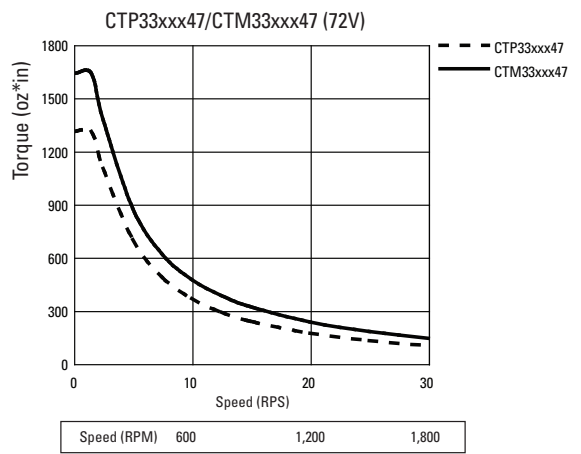
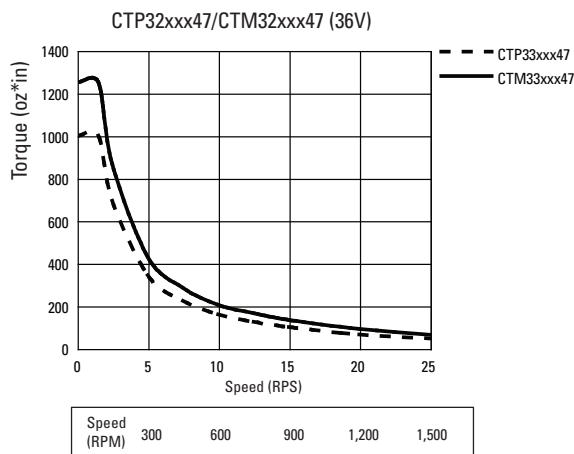
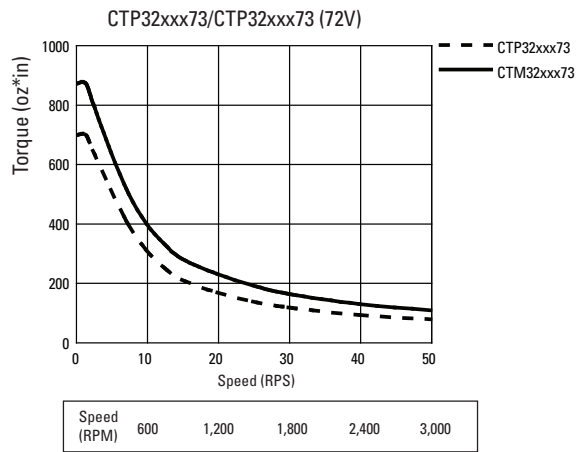
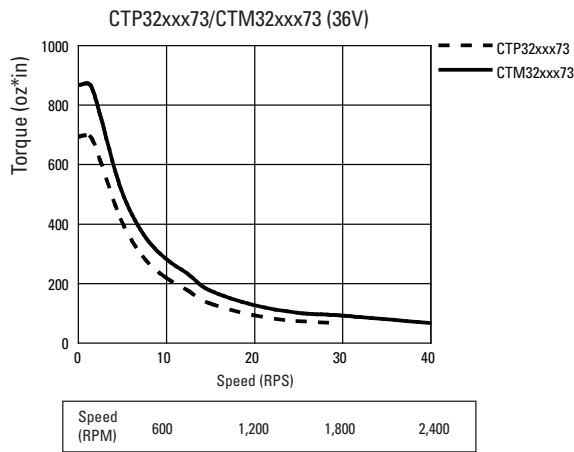
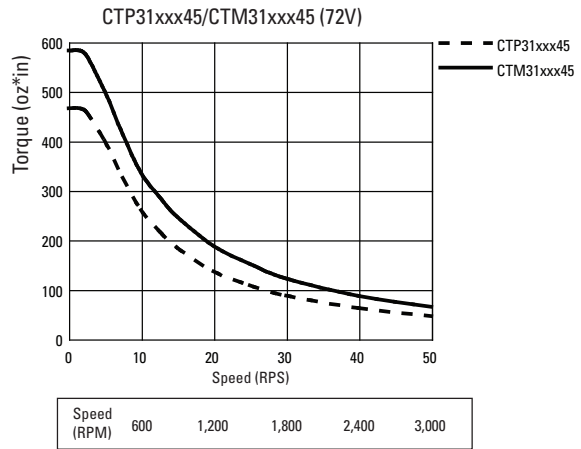
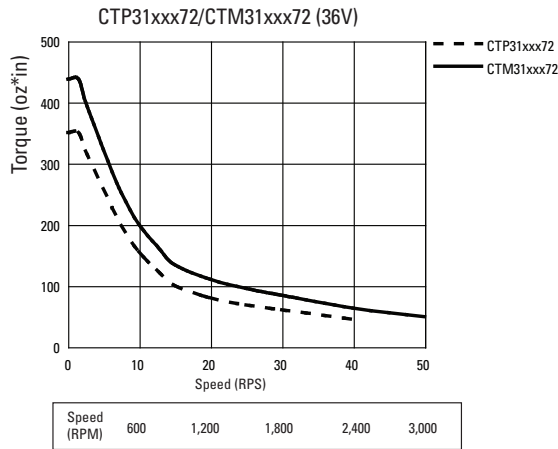

DC System Performance Curves

## Nema 34 - K Series

Below are speed-torque curves for the most popular Danaher Motion motors. Many additional motors and variants are available. Contact Danaher Motion for details.

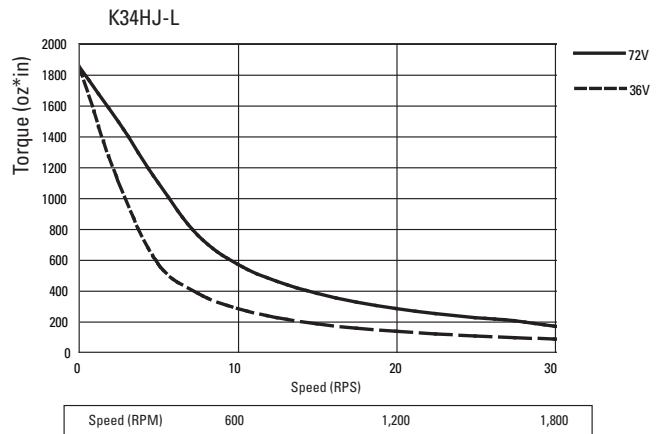
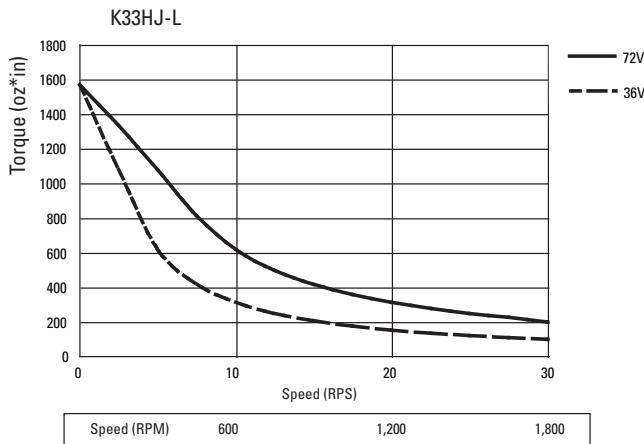
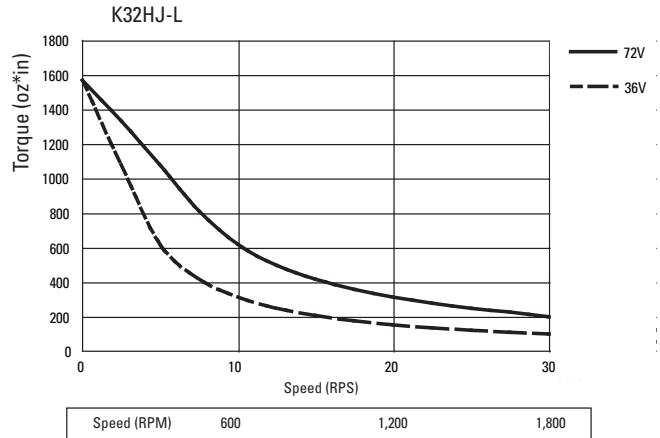
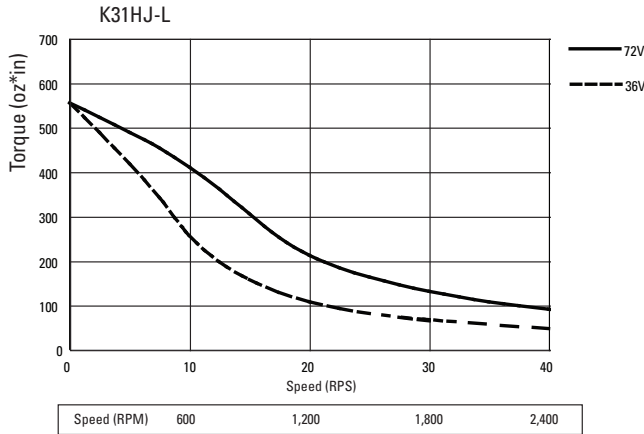

## Nema 42 - K Series

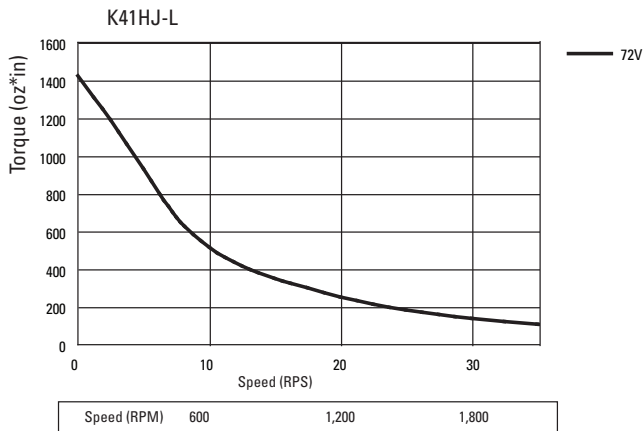

## AC System Performance Curves

### Nema 23 -CT Series

Below are speed-torque curves for the most popular Danaher Motion motors. Many additional motors and variants are available. Contact Danaher Motion for details.

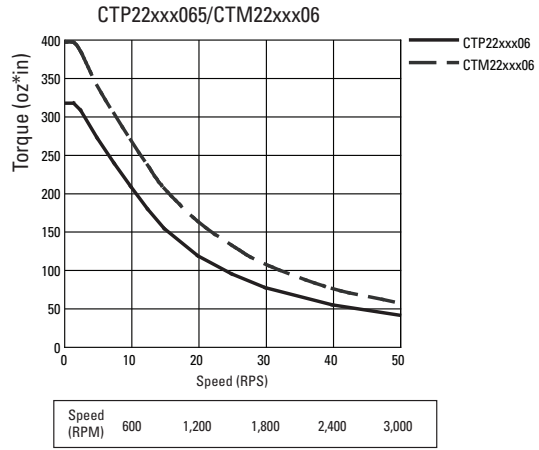
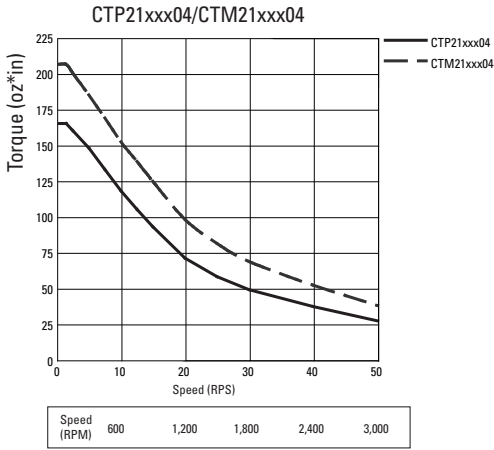

### Nema 34 -CT Series

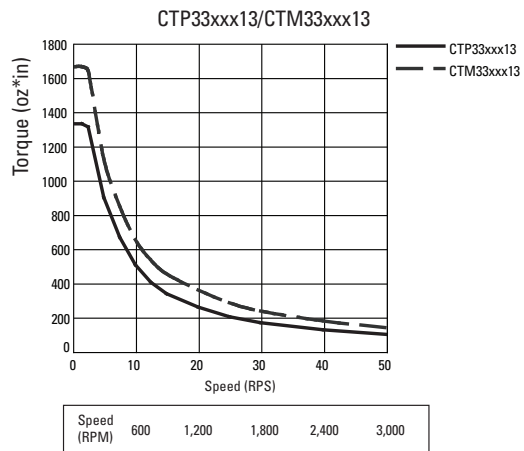
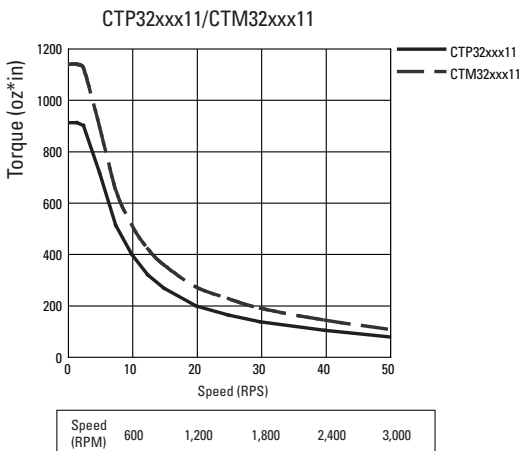
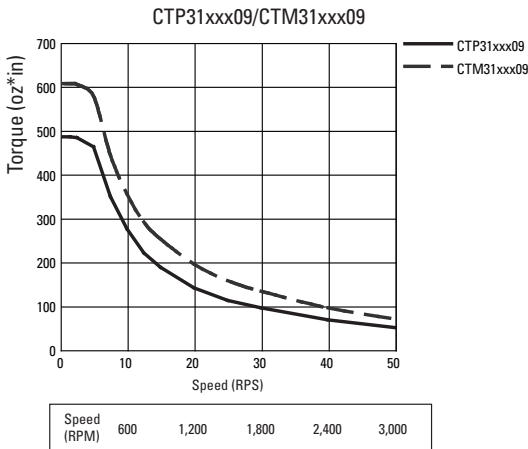

AC System Performance Curves

## Nema 34 - K Series

Below are speed-torque curves for the most popular Danaher Motion motors. Many additional motors and variants are available. Contact Danaher Motion for details.

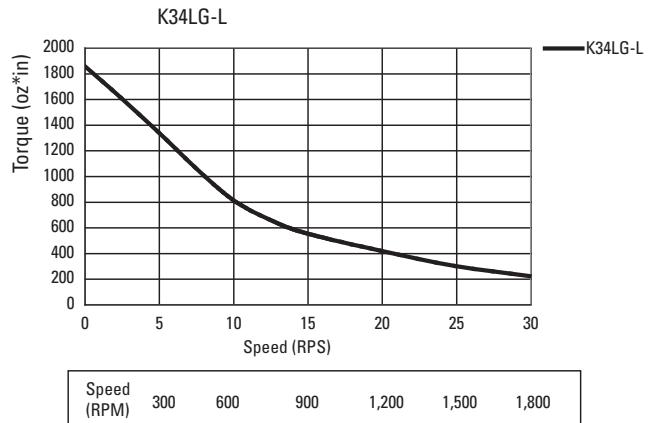
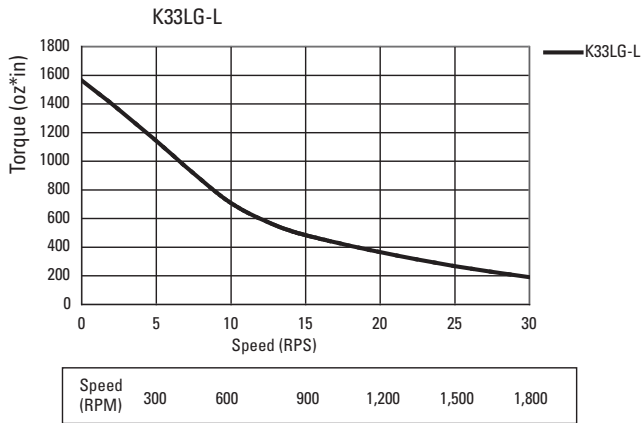
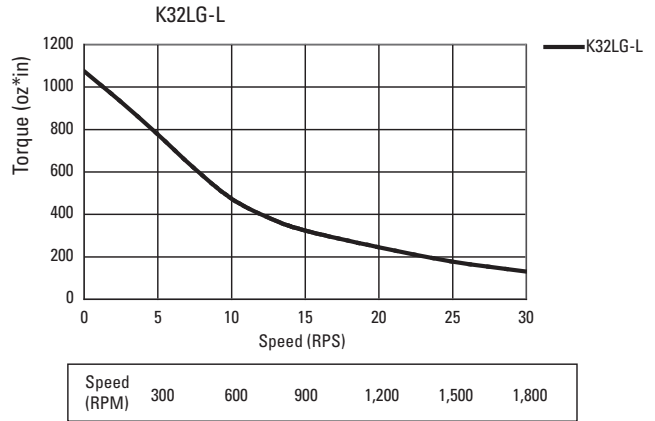
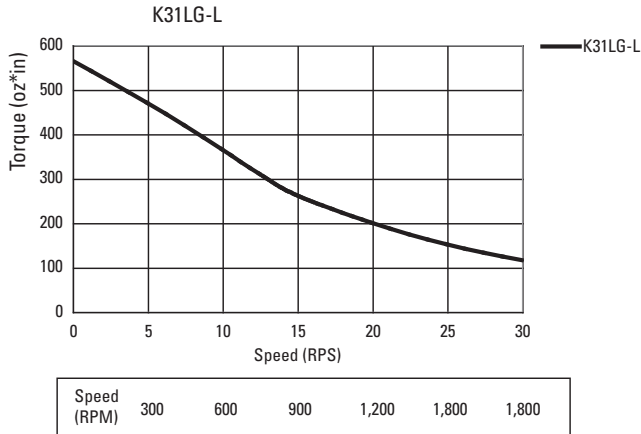

## Nema 42 - K Series

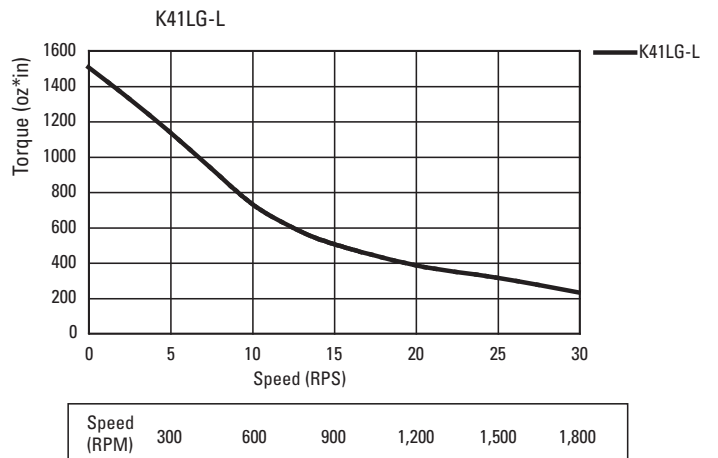
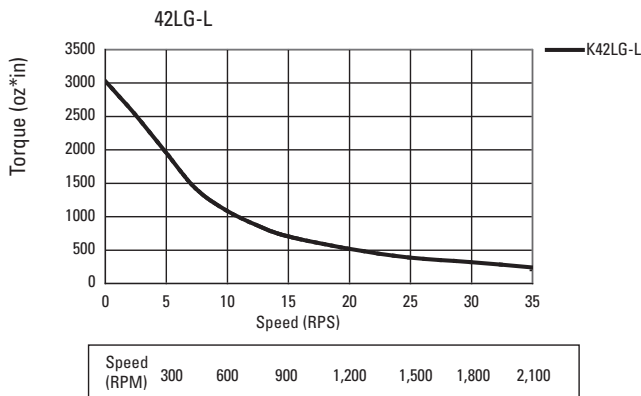

## P7000 Motor Selection Guide

	Configuration	P70530			P70360
		24V	36V	72V	320V
<b>CT Series</b>		N/A	X	X	
	CTP10xxx10	N/A	X	X	
	CTP11xxx17	N/A	X	X	
	CTP11xxx11	N/A	X	X	
	CTP12xxx26	N/A	X	X	
	CTP12xxx10	N/A	X	X	
	<b>Nema 23</b>				
	CTP20xxx27	N/A	X	X	
	CTP20xxx17	N/A	X	X	X
	CTP21xxx39	N/A	X	X	
	CTP21xxx25	N/A	X	X	X
	CTP21xxx15	N/A			X
	CTP22xxx50	N/A	X	X	
	CTP22xxx31	N/A	X	X	X
	CTP21xxx04	N/A			X
	CTP22xxx06	N/A			X
	<b>Nema 34</b>				
	CTP31xxx72	N/A		X	
	CTP31xxx28	N/A		X	X
	CTP31xxx45	N/A			X
	CTP31xxx09	N/A			X
CTP32xxx73	N/A		X	X	
CTP32xxx46	N/A			X	
CTP32xxx11	N/A			X	
CTP33xxx47	N/A		X	X	
CTP33xxx75	N/A			X	
CTP33xxx13	N/A			X	
<b>Enhanced CT Series</b>	<b>Nema 23</b>				
	CTM21xxx39	N/A	X	X	
	CTM21xxx25	N/A	X	X	X
	CTM21xxx15	N/A			X
	CTM22xxx50	N/A	X	X	
	CTM22xxx31	N/A	X	X	X
	CTM21xxx04	N/A			X
	CTM22xxx06	N/A			X
	<b>Nema 34</b>				
	CTM31xxx72	N/A		X	
	CTM31xxx28	N/A		X	X
	CTM31xxx45	N/A			X
	CTM31xxx09	N/A			X
	CTM32xxx73	N/A		X	X
	CTM32xxx46	N/A			X
CTM32xxx11	N/A			X	
CTM33xxx47	N/A		X	X	
CTM33xxx75	N/A			X	
CTM33xxx13	N/A			X	
<b>K Series</b>	<b>Nema 34</b>				
	K31xxxJ	Parallel		X	X
	K32xxxJ	Parallel		X	X
	K33xxxJ	Parallel		X	X
	K34xxxJ	Parallel		X	X
	K31xxxG	Series			X
	K32xxxG	Series			X
	K33xxxG	Series			X
	K34xxxG	Series			X
	<b>Nema 42</b>				
	K41xxxJ	Parallel		X	X
	K41xxxG	Series			X
	K42xxxG	Series			X

Note: If using a system above or below the specific voltage listed, please consult Danaher Motion.



P7000 Ordering and Product Information

# P7000 Model Number Scheme

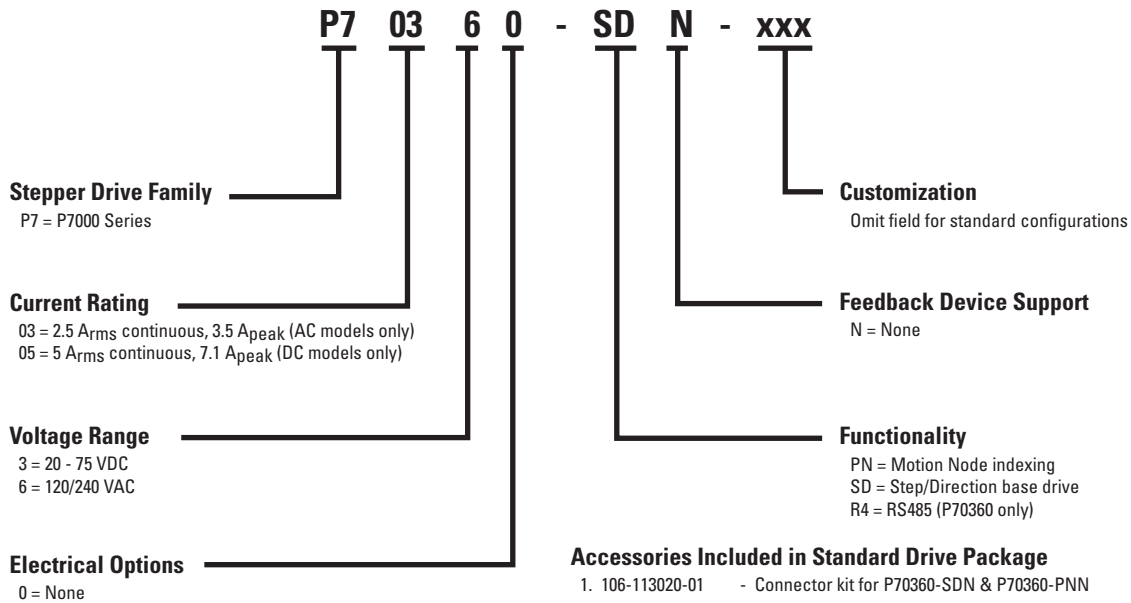

### Accessories Included in Standard Drive Package

- 106-113020-01 - Connector kit for P70360-SDN & P70360-PNN
- 106-111020-01 - Connector kit for P70530-SDN & P70530-PNN

### Accessories Not Included in Standard Drive Package

- 768-026902-01 - Terminal Block adaptor for I/O connector
- P7S2-232-9D - RS232 serial communication cable (DB-9 to Mod Jack) - 6 feet

Figure 2:  
Part Number  
768-026902-01

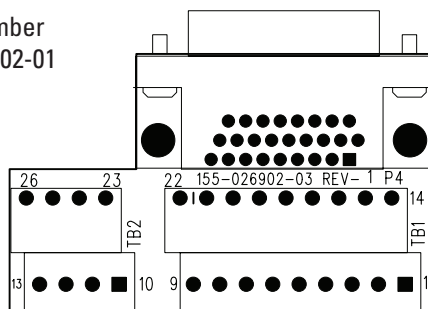

### NOTES:

- PERMANENTLY MARK PIN NUMBERS ON TERMINAL BLOCKS TB1 AND TB2 AS SHOWN.

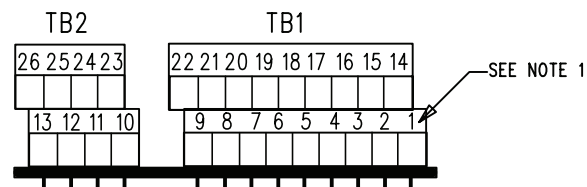

External power supplies available. Contact factory for selection assistance.

## Find Additional P7000 Product Information

DanaherMotion.com offers many new tools to help serve your needs. We've developed an intuitive Web-based system to increase your knowledge of motion control, search our vast product selection by product attribute (using our New Product Advisors), and easily locate your nearest Danaher Motion distributor or Sales office.

Visit [www.DanaherMotion.com](http://www.DanaherMotion.com) for more information and see our latest tools.



