



JVL...integration in motion

Industrial Ethernet expansion modules for MAC Motor[®]s



JVL is one of the leading companies in the field of integrated servo and stepper motors. JVL has set the goal of being the world leader in industrial Ethernet for integrated motors with the widest range of Industrial Ethernet communications for its range of Integrated Servo and Stepper motors. JVL has gained a high level of know-how and technological

expertise and can with this expansion module present a very smart way of using several Ethernet communications with only one expansion module you can choose between EtherCAT, Ethernet/IP, Profinet IO, Modbus TCP, Powerlink and Sercos III. The Industrial Ethernet module from JVL fits into the complete range of integrated servo motors from 50 W







to 3000 W, and is a versatile module which has the ability to be upgraded with other protocols or newer versions of the same protocol at any time. Because of the upgradeability, the JVL Industrial Ethernet module is also 'future proof' as newer versions of the protocols will always fit into the design.

Protocol key features

	Available	MacTalk over Ethernet	Synchroniza-tion	Drive profile	Further protocols
EtherCAT	✓	✓	✓	✓	SDO, CoE-Emcy
Ethernet/IP	✓	✓	Planned	Planned	DLR, DHCP, ACD
Profinet	✓	✓	Planned	Planned	RTC class 1-3, RTA, DCP, CL-RCP, LLDP, SNMP, MRP client
Powerlink	✓	Planned	Planned	Planned	-
Modbus TCP	✓	✓	-	-	DHCP
Sercos III	Planned	Planned	Planned	Planned	-



Ethernet modules for JVL MAC servo motors





	EtherCAT	Ethernet/IP	PROFINET IO	SERCOS III	Modbus TCP	Powerlink
						
Hardware	MAC00-EC4	MAC00-EI4	MAC00-EP4	MAC00-ES4	MAC00-ES4	MAC00-EL4
Available	Yes	Yes	Yes	Planned	yes	Yes
Application Protocol	CANopen (DS301+DSP402)	CIP	Profinet IO	SERCOS I/II	Modbus	CANOPEN
Company	Beckhoff	Rockwell	Siemens	Bosch Rexroth		B&R
MacTalk over Ethernet	Yes	Yes	Yes	Planned	Yes	Planned
Transport Protocol	EtherCAT EtherCAT/UDP	TCP/IP, UDP/IP	TCP/IP, UDP/IP, Profinet RT		TCP/IP	Powerlink V2
Synchronization	DC, 32bit	Planned	Planned	Planned	-	Planned
Drive profile	CiA402	Planned	Planned	Planned	-	Planned
Network Minimum cycle time	<50 μ S	2 mS	1 mS	250 μ S	~2mS	<200 μ S
Module Minimum cycle time ²⁾	360 μ S at 1/1 ¹⁾ 500 μ S at 5/5 605 μ S at 8/8 ¹⁾	1mS	1 ms at 5/5 1,2 ms at 8/8		1 reg. 1mS 10 reg. 4mS	360 μ S at 1/1 500 μ S at 5/5 605 μ S at 8/8 ¹⁾
Address Range	65535	65535	65535	65535	65535	256
Max. Baudrate	EtherNet 100Mbit/s	EtherNet 100Mbit/s	EtherNet 100Mbit/s	EtherNet 100Mbit/s	EtherNet 100Mbit/s	EtherNet 100Mbit/s
Network topology	Line, Ring, Star, Tree	Switches routers wireless	Switches routers wireless	Line, Ring	Switches routers wireless	Line, Star, Tree
Standards	IEC61158, IEC/ PAS 62407, IEC61784-3, ISO15745-4	IEC 61158/ IEC61784/ ODVA EtherNet/ IP standard	IEC 61158/ IEC61784	IEC 61491 merged into IEC61158	IEC 61158 and IEC61784	IEC 61158, EPG (Ether- Net Powerlink standardization Group)
Further supported protocols	SDO, CoE	DHCP, ACD, DLR	RTC class 1-3, RTA, DCP, CL-RCP,LLDP, SNMP, MRP client		DHCP	
User org.	ETG	ODVA	Profibus Int	Sercos North America, Sercos International	Modbus Org.	EPG

¹⁾ Reading 1 register and writing to 1 register or 5 and 5.

²⁾ Only applicable for MAC400-MAC3000, for MAC050-141 please look in the manual.



Summary of the available Industrial Ethernet protocols from JVL

	<p>EtherCAT is an open real-time Ethernet Master/Slave network developed by Beckhoff. Today, it is an open standard, managed by the EtherCAT technology group.</p> <p>EtherCAT sets new limits for real-time performance since it processes 1000 distributed I/O in 30 μs or 100 axis in 100 μs using twisted pair or fiber optic cable. Regarding topology, EtherCAT supports a simple low cost line structure, a tree structure, daisy chaining or drop lines – no expensive infrastructure components are required. Alternatively the classic more expensive switched star topology can be used.</p>
	<p>The Industrial Ethernet Protocol (Ethernet/IP) was originally developed by Rockwell Automation and is now managed by the Open DeviceNet Vendors Association (ODVA). It is an already well established Industrial Ethernet communication system with good Real-Time capabilities.</p> <p>EtherNet/IP is standardized in the International standard IEC 61158 and Ethernet/IP devices are certified by ODVA for interoperability and conformance.</p> <p>EtherNet/IP extends commercial off-the-shelf Ethernet to the Common Industrial Protocol (CIP) – the same upper-layer protocol and object model found in DeviceNet and ControlNet.</p> <p>CIP allows Ethernet/IP and DeviceNet system integrators and users to apply the same objects and profiles for plug-and-play interoperability among devices from multiple vendors and in multiple sub-nets. Combined, DeviceNet, ControlNet and Ethernet/IP promote transparency from sensors to the enterprise software.</p>
	<p>PROFINET is the innovative open standard for Industrial Ethernet, development by Siemens and the Profibus User Organization (PNO).</p> <p>With PROFINET, solutions can be implemented for factory and process automation, for safety applications, and for the entire range of drive technology right up to clock-synchronized motion control.</p> <p>PROFINET is standardized in IEC 61158 and IEC 61784. Profinet products are certified by the PNO user organization, guaranteeing worldwide compatibility.</p>
	<p>Modbus was originally developed by Modicon and today, it is managed by the Modbus-IDA User Organization.</p> <p>Modbus is an open Master/Slave application protocol, that can be used on several different physical Layers. Modbus is an application-layer messaging protocol, positioned at level 7 of the OSI model. It provides client/server communication between devices connected on different types of buses or networks.</p>
	<p>Ethernet POWERLINK® is a proven technology, working in real applications worldwide. It embraces standard Ethernet technology and infrastructure, uses standard CAT5 shielded cabling and does not compromise standard Ethernet frames in order to achieve its results. Ethernet POWERLINK® operates as a protected segment by design, and connects to a none-deterministic Ethernet network via a gateway.</p> <p>Unlike standard Ethernet, the Slot Communication Network Management ensures that only one node is accessing the network at a time. The schedule is divided into an isochronous phase and an asynchronous phase. During the isochronous phase, time-critical data is transferred, while the asynchronous phase provides bandwidth for the transmission of data that is not time-critical. Ethernet POWERLINK® applies the same protocol technology as CANopen. It defines SDOs (Service Data Objects), PDOs (Process Data Objects) and the Object Dictionary structure to manage the parameters.</p>

Block diagram for MAC00-Ex4 & Ex41 Ethernet module

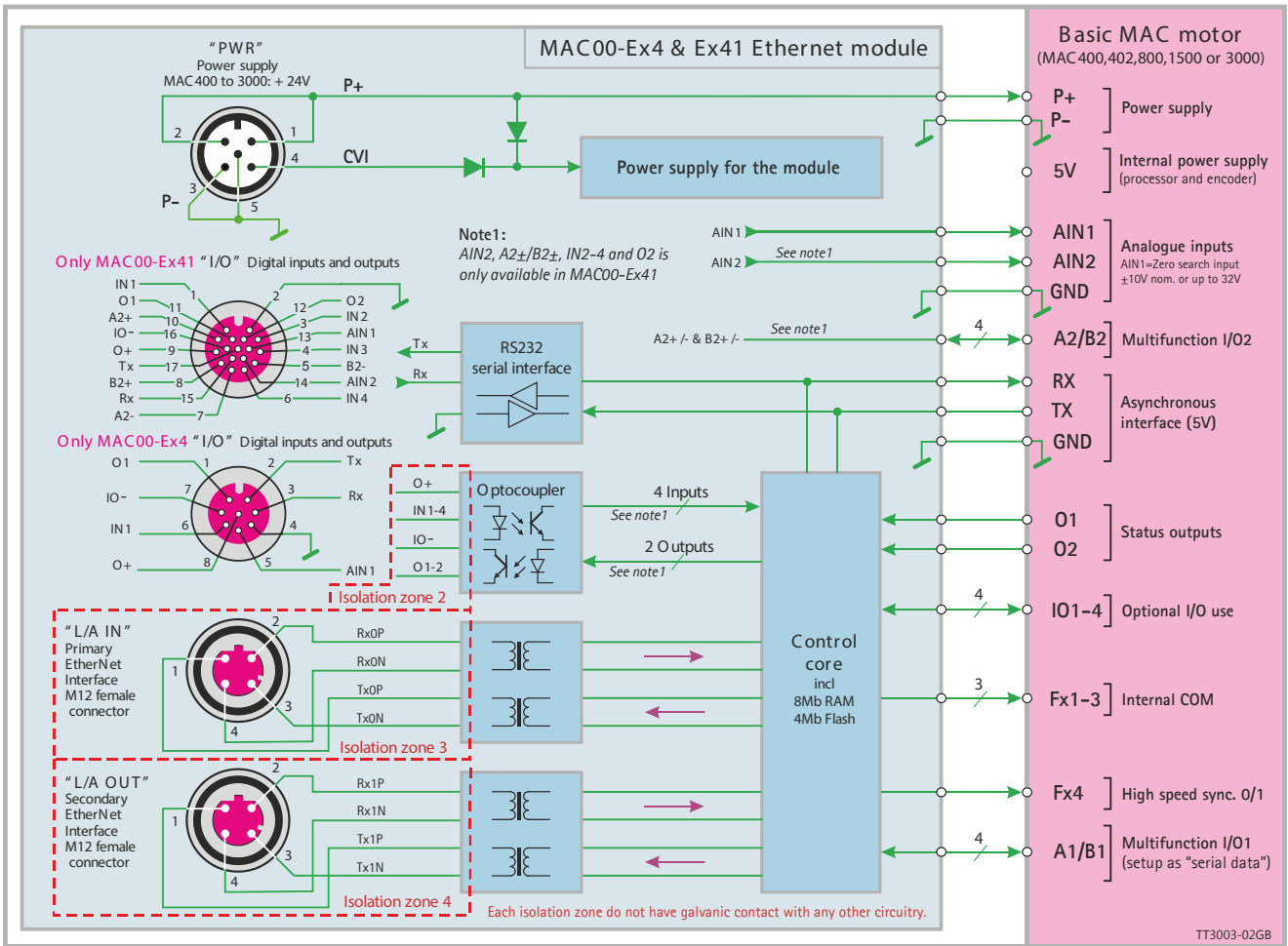

Features not available when module is mounted in a MAC050-MAC141:

- Synchronization not possible.
- The AIN2 and Multifunction I/O 2 are not available.

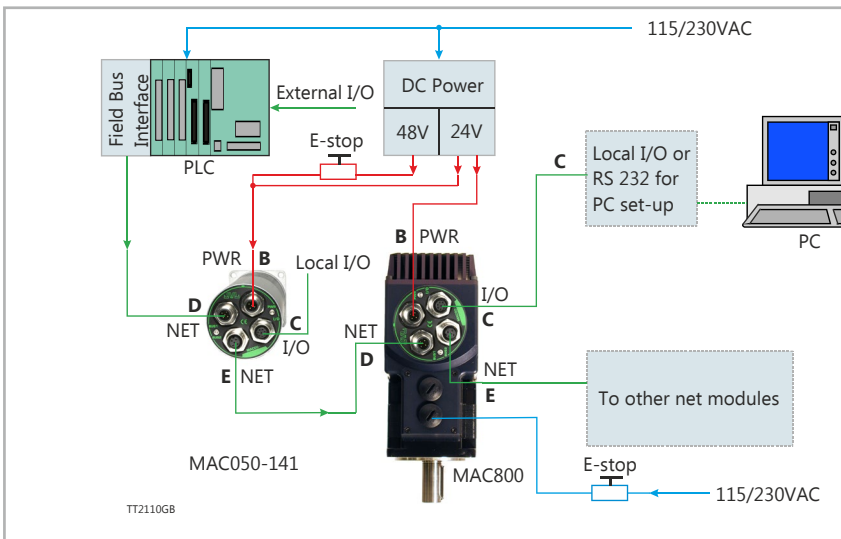

Two MAC motors in a network

Did you know that...

The communication with 100 servo axes only takes 100 μs. During this time, all axes are provided with set values and control data and report their actual position and status. The distributed clock technique enables the axes to be synchronized with a deviation of significantly less than 1 microsecond.

Technical specifications

Absolute maximum rating

Description	Min	Typ	Max	Absolute Max	Unit
CV Current@ 24VDC ¹⁾		150	250		mA
Voltage O+	10		30	32	VDC
Voltage P+	12		48	50	VDC
Control Voltage CV	12		48	50	VDC
Input	4.5		28	32	VDC
Input Impedance		4.7			kOhms
Input current @24V		5.1			mA
Analoque input ²⁾	-10		10	32	VDC
Output	0		30	32	VDC
Output current			15		mA

¹⁾ Only expansion module. Remember to add the current for the basic motor
²⁾ Resolution 11bit+sign for MAC400-3000 and 9bit+sign for MAC050-MAC141

Easy start with sample code

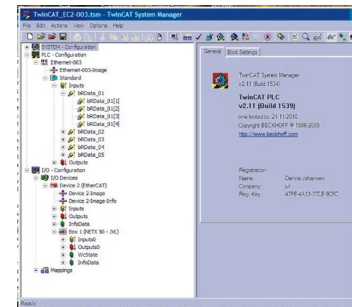

At no additional cost, sample codes for all available protocols for the most used PLC vendors, can be downloaded from www.jvl.dk in the Downloads / Software section of the website. The examples are made for specific PLC and JVL motor types but can easily be converted to other motors and/or PLC's.

PA0190 IO gateway for MAC motor and MIS motor with 17 pin connetor

PA0190 is an IO gateway for the MAC-motor and the MISmotor with 17pin M12 connectors. It can be MACmotor Industrial Ethernet modules MAC00-Ex41 and MIS34x/MIL34x motor with 17pin M12 connector. The gateway splits the 17 pin connector into 4pcs M12 connectors with different functions:

- RS232 (MAC) or RS485 (MIS) serial interface.
- I1-4 + O1-2 + AIN1-2 (MAC) or IO1-8 (MIS) for local input/output/zero search switch or limit sensors.
- RS422 signal for eg external encoder.
- 17 pin if some of the signals should be directed to the control cabinet.



Thereby can local machine IO be connected directly to the integrated motor without passing through the control cabinet. The gateway are a perfect solution for harsh industrial environments. Fully molded and assembled

with M12 connectors it is IP67 compliant to resist the most extreme conditions. It enables cabinet installations to be shifted into the field for operation in tough environment such as high humidity or hazardous areas.



Easy installation with M12 connector

The JVL Industrial Ethernet expansion module is equipped with 2 Ethernet connectors and a built-in switch, enabling line topology without any extra (expensive) hardware. The module has several LEDs, enabling technicians and operators to get a quick status overview. There are also opto-isolated digital I/Os embedded in the module, enabling control of extra sensors etc

without external I/O modules. This minimizes the number of devices on the net and also reduces cable costs. All connectors are rugged M12 connectors suitable for the rough conditions in industrial environments. The connectors are with 4, 5 and 8 pins, and optional 17 pins in the extended I/O version. To ease installation there is two Ethernet connectors, one for

Input and one for Output. Furthermore, all registers in the JVL MAC motor are accessible via the Ethernet connection, thereby enabling complete control of motor configuration and motion. The JVL module is very easy to use and configure via a predefined setup, and is easy to alter using the JVL Mac-Talk application software.

Motor Connector Description

		M12 Connector	1	2	3	4	5	6	7	8	
Up link to master	EtherNet	<p>4 pin Female «D»</p>	TX0_P	RX0_P	TX0_N	RX0_N					
	Cable Color code		Brown/White	Blue/White	Brown	Blue					
Down link to other slave	EtherNet	<p>4 pin Female «D»</p>	TX1_P	RX1_P	TX1_N	RX1_N					
	Cable Color code		Brown/White	Blue/White	Brown	Blue					
PWR (Power supply)	EtherNet	<p>5 pin Male</p>	P+ (12-48VDC)	P+ (12-48VDC)	P- (GND)	CV control voltage	P- (GND)				
	Cable Color code		Brown	White	Blue	Black	Grey				
I/O	EtherNet	<p>8 pin Female</p>	OUT1 or A2+	Tx (RS232)	Rx (RS232)	GND (RS232)	AIN1	IN1 or B2-	IO-GND or B2+	OUT+ or A2-	
	Cable Color code		White	Brown	Green	Yellow	Grey	Pink	Blue	Red	
I/O	EtherNet	M12 Connector	1	2	3	4	5	6	7	8	9 ¹⁾
		M12 Female 17 pin	IN1	GND	IN2	IN3	B2-	IN4	A2-	B2+	Out+
	Cable Color code	<p>17 pin Female</p>	Brown	Blue	White	Green	Pink	Yellow	Black	Grey	Red
			10	11	12	13	14	15	16	17	
	EtherNet		A2+	O1	O2	AIN1	AIN2	RS232: RX	IO-	RS232: TX	
Cable Color code		Violet	Grey/pink	Red/blue	White/green	Brown/green	White/yellow	Yellow/brown	White/grey		

¹⁾ Output 1 and 2 supply input . DO NOT connect >30V to this terminal!



Hardware overview

Expansion module MAC00-Ex4 and Ex41 front plate
Neutral module for all the Ethernet protocols
(MAC00-Ex4 shown)

Module status indicators.

L/A IN
Primary Ethernet channel M12 - 4pin female (D-coded) and LED for showing activity.

L/A OUT
Secondary Ethernet channel M12 - 4pin female Ethernet coded (D coded) Used when module is daisy chained

MAC Address
Each module is having its own unique MAC address used to identify it on the Ethernet network. The MAC address can also be read electronically

PWR
Power supply connector M12 - 5pin male and Green LED for indicating power applied

I/O
I/O's and RS232 interface
MAC00-Ex4 (basic version) M12 - 8pin female
1 digital input and 1 digital output, 1 analogue input
MAC00-Ex41 (ext. version) M12 - 17pin female
4 digital inputs and 2 digital outputs, 2 analogue input
2 RS485 channels

Serial number
Each module have its own unique serial number which can be used for determine hardware version etc.

TT3038-01GB

The standard expansion module MAC00-Ex4 is equipped with 1 analogue input, 1 digital input and 1 digital output. With the extended I/O version MAC00-Ex41, is used a 17 pin

I/O connector where 4 digital inputs, 2 digital outputs, 2 analogue inputs and a RS422/RS485 multifunction I/O are available. The digital I/O's on both module types are galvanic isolated.

Contact JVL if other configurations are required. For OEM use, a solution with customer specified connectors can be delivered.

Industrial Ethernet expansion module with 17pin M12 connectors. MAC00-Ex41

Features:

- 17 pin M12 connector for IO. Total 4x M12
- Control and setup through Ether-CAT
- EtherCAT input and output. Switch built-in
- For built-in PLC with (MAC400-3000) or HWI for MAC050-141 etc.
- 4 digital inputs for enable, limit etc.
- 2 digital opto-isolated outputs up to 15mA for In Position, Error etc.
- 2 analogue inputs for zero search or adjustment etc.
- RS422 for encoder or pulse/direction IO
- Protection IP67
- RS232 interface



Cables and accessories

Description M12 IP67 (Standard cable with shield)	Connector	Type code
RS232 programming cable	I/O	RS232-M12-1-5-8
Power cable	PWR	WI1000-M12F5VxxN ¹⁾
IO cable	I/O	WI1000-M12F8VxxN ¹⁾
BUS cable, D-Code, 4 pin	BUS1	WI1004-M12M4SxxR ¹⁾
Protection cap for M12 male	BUS1/BUS2	WI1000-M12MCAP1
Protection cap for M12 female	BUS2 or I/O	WI1000-M12FCAP1
Connector 5 pin female straight solder terminals	PWR	WI1008-M12F5SSC
Connector 4 pin Male straight presslock, D-Code	BUS1/BUS2	WI1048-M12M4TRI
17 pin I/O cable	I/O	WI1009-M12M17T05N
EtherNet cable with RJ45 and M12 4 pin D-Code	BUS1	WI1046-M12M4S05NRJ45
M12 cable 1m 4p Male to 4p Male 180° Ethernet	BUS1	WI1046-M12M4TM4TxxR ²⁾
IO gateway for MACmotor and MISmotor with 17 pin M12 connectors.	I/O	PA0190
24VDC/75W Power Supply for I/O		PSU24-075

1) The cable is available in 5, 15 or 20 meter (flying leads)

2) The cable is Available in 1 or 5 meter



JVL Industri Elektronik A/S
 Blokken 42
 DK-3460 Birkerød, Denmark
 Tel.: +45 4582 4440
 E-mail: jvl@jvl.dk www.jvl.dk

JVL Deutschland
 Tel.: +49 7121 137 7260
 E-mail: jan.tausend@jvl.dk
 www.jvl drives.de

JVL USA
 Tel.: +1 513/877-3134
 E-mail: mfisher@jvlusa.com
 www.jvlusa.com

JVL Turkey
 Tel.: +90 216 3891644
 email: ozkan.ozel@jvl.dk
 www.jvl.dk

Ordering information

MAC00-EX41

Motor Type
AC-brushless serie

Expansion module

TT1547-01

4: 8pin I/O connector
 41: Extended I/O version
 with 17 pin I/O connector

Ethernet protocol:
 EI: Ethernet IP
 EC: EhterCAT
 EP: Profinet
 ES: Sercos III
 EM: Modbus TCP
 EL: Powerlink

