

- Slider Type
- Mini
- Standard
- Controllers Integrated
- Rod Type
- Mini
- Standard
- Controllers Integrated

X-SEL

Program controller
For RCS2 series







- Table/Arm /FlatType
- Mini
- Standard
- Gripper/ Rotary Type
- Linear Servo Type
- Cleanroom Type
- Splash-Proof

- Controllers
- PMEC /AMEC
- PSEP /ASEP
- ROBO NET
- ERC2
- PCON
- ACON
- SCON
- PSEL
- ASEL
- SSEL
- XSEL

List of models

Multiaxial program controller for operating RCS2 Series actuators. Up to 6 axes can be simultaneously controlled.

Type	J	K	P	Q
Name	Compact Type	General Purpose Type	Large-Capacity Type	Large-Capacity Type (Safety Category Compliant)
External View				
Description	Compact, low-cost type ideal for operating low-output actuators	Standard type offering excellent expandability	Large-capacity type capable of controlling up to six axes or 2,400W	Large-capacity type conforming to safety category 4
Maximum number of control axes	4-axis		6-axis	
Number of positions	3,000 positions		20,000 positions	
Total Number of Connectable W	800W	1600W	2400W	
Power Supply	Single-phase AC100V/Single-phase AC200V		Single-phase AC200V/3-phase AC200V	
Safety Category	B		B	Category 4 compatible
Safety Rating	-	-	CE	CE, ANSI

(*1) The maximum output for 1 shaft during vertical operation is limited to 600W.

(*2) Axis 5 and axis 6 cannot control the RCS2-RA7/SRA7 series.

- Pulse Motor
- Servo Motor (24V)
- Servo Motor (200V)
- Linear Servo Motor

587 XSEL

Sold & Serviced By: **ELECTROMATE**

Toll Free Phone (877) SERV098
Toll Free Fax (877) SERV099
www.electromate.com
sales@electromate.com

System configuration

J (small) / K (general) / KE (CE type)

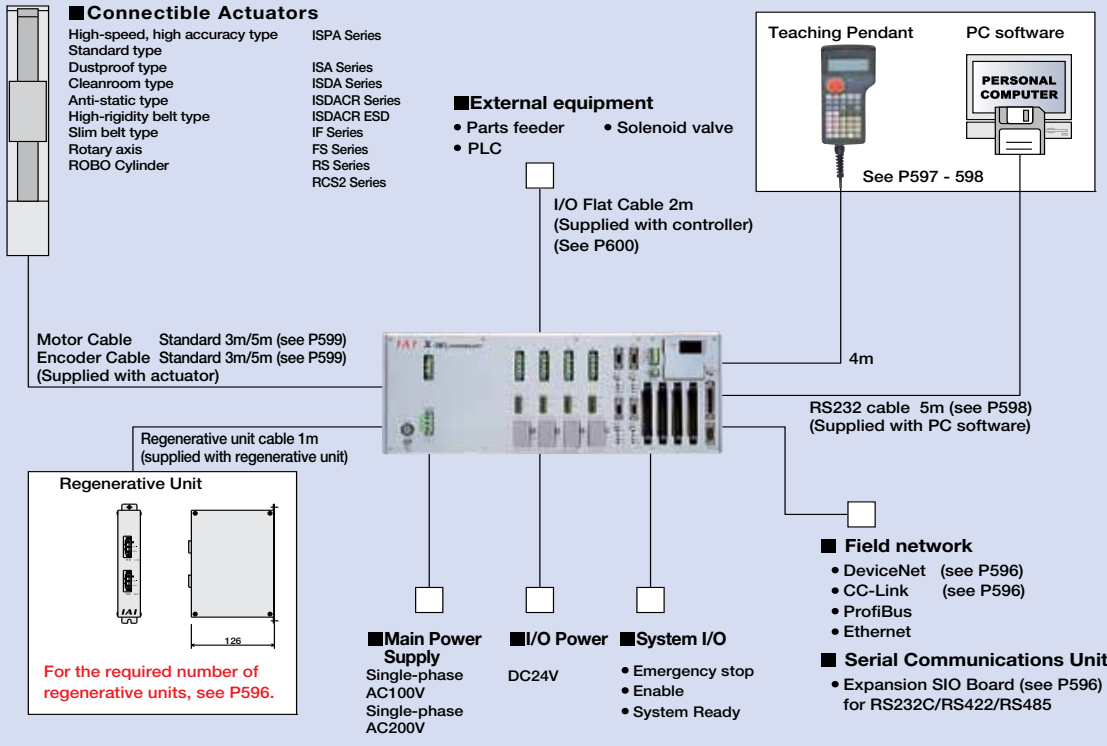

P (high-capacity type) / Q (high-capacity global type)

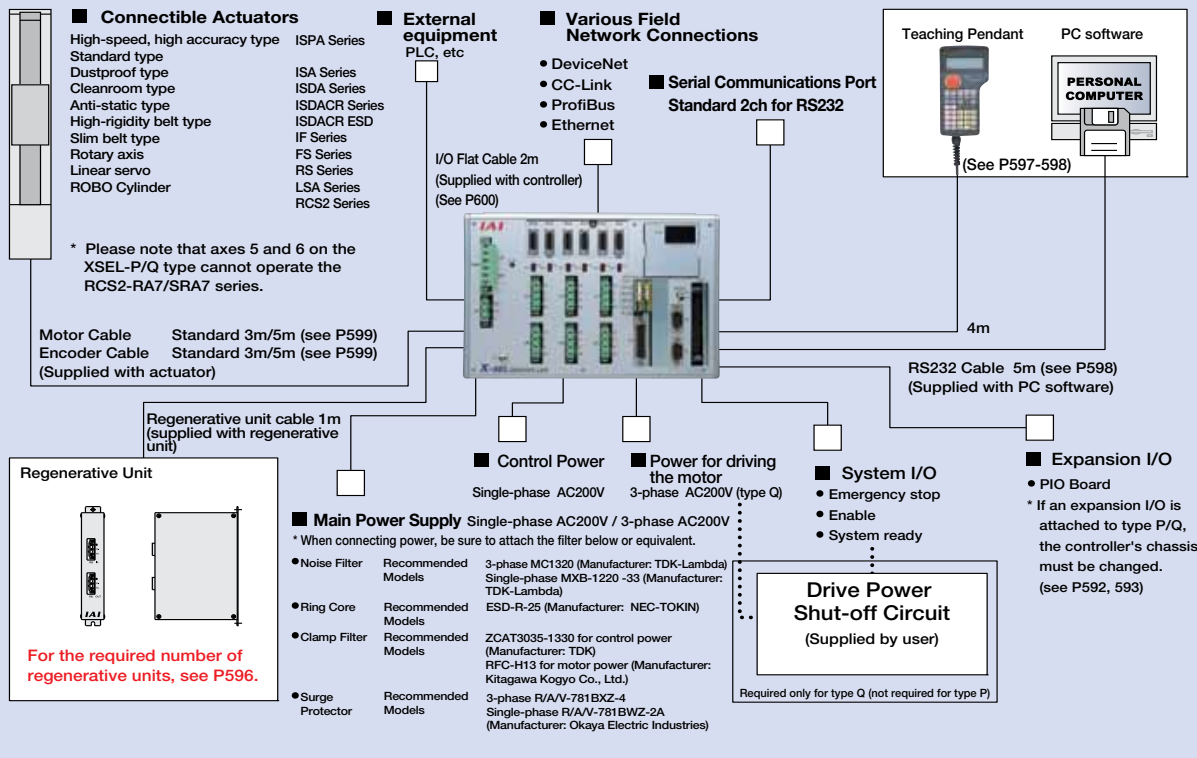

589 XSEL

Sold & Serviced By:

ELECTROMATE
Toll Free Phone (877) SERV098
Toll Free Fax (877) SERV099
www.electromate.com
sales@electromate.com

- Slider Type
- Mini
- Standard
- Controllers Integrated
- Pod Type
- Mini
- Standard
- Controllers Integrated
- Table/Arm /FlatType
- Mini
- Standard
- Gripper/ Rotary Type
- Linear Servo Type
- Cleanroom Type
- Splash-Proof
- Controllers
- PMEC /AMEC
- PSEP /ASEP
- ROBO NET
- ERC2
- PCON
- ACON
- SCON
- PSEL
- ASEL
- SSEL
- XSEL
- Pulse Motor
- Servo Motor (24V)
- Servo Motor (200V)
- Linear Servo Motor

I/O wiring drawing

Input section External input specification (NPN specification)

Item	Specifications
Input voltage	DC24V ±10%
Input current	7mA / circuit
ON/OFF voltage	ON Voltage... Min DC16.0V / OFF Voltage... Max DC5.0V
Isolation method	Photocoupler
Externally Connected Equipment	(1) Non-Voltage Contact (Minimum load around DC5V, 1mA) (2) Photoelectric Proximity Sensor (NPN Type) (3) PLC Transistor Output (Open Collector Type) (4) PLC Contact Output (Minimum Load approx. DC5V, 1mA)

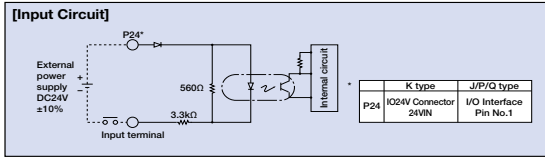

Input section External input specification (PNP specification)

Item	Specifications
Input voltage	DC24V ±10%
Input current	7mA / circuit
ON/OFF voltage	ON Voltage... Min DC8V / OFF Voltage... Max DC19V
Isolation method	Photocoupler
Externally Connected Equipment	(1) Non-Voltage Contact (Minimum load around DC5V, 1mA) (2) Photoelectric Proximity Sensor (PNP Type) (3) PLC Transistor Output (Open Collector Type) (4) PLC Contact Output (Minimum Load approx. DC5V, 1mA)

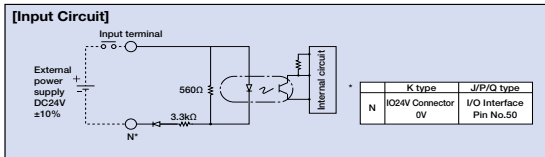

Output section External input specification (NPN specification)

Item	Specifications
Load Voltage	DC24V
Max. load current	100mA / point 400 mA
Leak current	Peak (Total Current)
Isolation method	Max 0.1mA / point
Externally Connected Equipment	Photocoupler
Equipment	(1) Miniature Relay, (2) PLC Input Unit

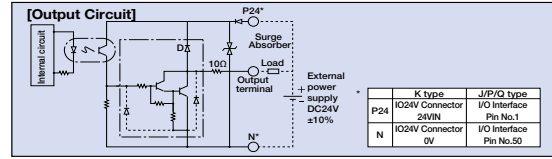

Output section External input specification (PNP specification)

Item	Specifications
Load Voltage	DC24V
Max. load current	100mA / 1 point 400mA / 8 port (Note)
Leak current	Max 0.1mA / point
Isolation method	Photocoupler
Externally Connected Equipment	(1) Miniature Relay, (2) PLC Input Unit

(Note) 400mA is the maximum total load current for each set of the eight ports from output port No. 300. (The maximum total current output for output port No. 300+n to No. 300+n+7 must be 400mA, where n = 0 or a multiple of eight.)

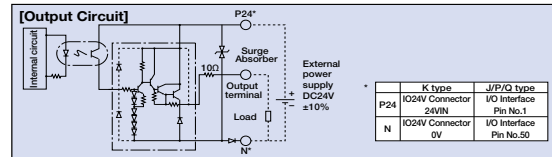

I/O Signal table

Standard I/O Signal Table (when N1 or P1 is selected)

Pin No.	Classification	Port No.	Standard Settings
1		—	(J/P/Q type: 24V connection / K type: NC)
2		000	Program start
3		001	General Purpose Input
4		002	General Purpose Input
5		003	General Purpose Input
6		004	General Purpose Input
7		005	General Purpose Input
8		006	General Purpose Input
9		007	Program Specification (PRG No. 1)
10		008	Program Specification (PRG No. 2)
11		009	Program Specification (PRG No. 4)
12		010	Program Specification (PRG No. 8)
13		011	Program Specification (PRG No. 10)
14		012	Program Specification (PRG No. 20)
15		013	Program Specification (PRG No. 40)
16	Input	014	General Purpose Input
17		015	General Purpose Input
18		016	General Purpose Input
19		017	General Purpose Input
20		018	General Purpose Input
21		019	General Purpose Input
22		020	General Purpose Input
23		021	General Purpose Input
24		022	General Purpose Input
25		023	General Purpose Input
26		024	General Purpose Input
27		025	General Purpose Input
28		026	General Purpose Input
29		027	General Purpose Input
30	028	General Purpose Input	
31	029	General Purpose Input	
32	030	General Purpose Input	
33	031	General Purpose Input	
34	300	Alarm Output	
35	301	Ready Output	
36	302	Emergency Stop Output	
37	303	General Purpose Output	
38	304	General Purpose Output	
39	305	General Purpose Output	
40	306	General Purpose Output	
41	307	General Purpose Output	
42	308	General Purpose Output	
43	309	General Purpose Output	
44	310	General Purpose Output	
45	311	General Purpose Output	
46	312	General Purpose Output	
47	313	General Purpose Output	
48	314	General Purpose Output	
49	315	General Purpose Output	
50		—	(J/P/Q type: 0V connection/K type: NC)

Extension I/O Signal Table (when N1 or P1 is selected)

Pin No.	Classification	Standard Settings
1		(J/P/Q type: 24V connection / K type: NC)
2	Input	General Purpose Input
3		General Purpose Input
4		General Purpose Input
5		General Purpose Input
6		General Purpose Input
7		General Purpose Input
8		General Purpose Input
9		General Purpose Input
10		General Purpose Input
11		General Purpose Input
12		General Purpose Input
13		General Purpose Input
14		General Purpose Input
15		General Purpose Input
16		General Purpose Input
17		General Purpose Input
18		General Purpose Input
19		General Purpose Input
20		General Purpose Input
21		General Purpose Input
22		General Purpose Input
23		General Purpose Input
24		General Purpose Input
25		General Purpose Input
26		General Purpose Input
27		General Purpose Input
28		General Purpose Input
29		General Purpose Input
30		General Purpose Input
31		General Purpose Input
32		General Purpose Input
33	General Purpose Input	
34	General Purpose Output	
35	General Purpose Output	
36	General Purpose Output	
37	General Purpose Output	
38	General Purpose Output	
39	General Purpose Output	
40	General Purpose Output	
41	General Purpose Output	
42	General Purpose Output	
43	General Purpose Output	
44	General Purpose Output	
45	General Purpose Output	
46	General Purpose Output	
47	General Purpose Output	
48	General Purpose Output	
49	General Purpose Output	
50		(J/P/Q type: 0V connection/K type: NC)

Extension I/O Signal Table (when N2 or P2 is selected)

Pin No.	Classification	Standard Settings
1		(J/P/Q type: 24V connection / K type: NC)
2	Input	General Purpose Input
3		General Purpose Input
4		General Purpose Input
5		General Purpose Input
6		General Purpose Input
7		General Purpose Input
8		General Purpose Input
9		General Purpose Input
10		General Purpose Input
11		General Purpose Input
12		General Purpose Input
13		General Purpose Input
14		General Purpose Input
15		General Purpose Input
16		General Purpose Input
17		General Purpose Input
18		General Purpose Output
19		General Purpose Output
20		General Purpose Output
21		General Purpose Output
22		General Purpose Output
23		General Purpose Output
24		General Purpose Output
25		General Purpose Output
26		General Purpose Output
27		General Purpose Output
28		General Purpose Output
29		General Purpose Output
30		General Purpose Output
31		General Purpose Output
32		General Purpose Output
33	General Purpose Output	
34	General Purpose Output	
35	General Purpose Output	
36	General Purpose Output	
37	General Purpose Output	
38	General Purpose Output	
39	General Purpose Output	
40	General Purpose Output	
41	General Purpose Output	
42	General Purpose Output	
43	General Purpose Output	
44	General Purpose Output	
45	General Purpose Output	
46	General Purpose Output	
47	General Purpose Output	
48	General Purpose Output	
49	General Purpose Output	
50		(J/P/Q type: 0V connection/K type: NC)

Slider Type

Mini

Standard

Controllers Integrated

Pcd Type

Mini

Standard

Controllers Integrated

Table/Arm /FlatType

Mini

Standard

Gripper/ Rotary Type

Linear Servo Type

Cleanroom Type

Splash-Proof

Controllers

PMEC /AMEC

PSEP /ASEP

ROBO NET

ERC2

PCON

ACON

SCON

PSEL

ASEL

SSEL

XSEL

Pulse Motor

Servo Motor (24V)

Servo Motor (200V)

Linear Servo Motor

Table of specifications

J (Compact) / K (General Purpose)

Item	Description												
	J (Compact) Type						K (General Purpose) Type / KE (CE Compatible) Type						
Controller Series, Type	J (Compact) Type / K (General Purpose) Type / KE (CE Compatible) Type												
Connecting actuator	RCS2 / ISA / ISPA / ISP / ISDA / ISDACR / ISPDACR / IF / FS / RS												
Compatible Motor Output (W)	20 / 30 / 60 / 100 / 150 / 200 / 300 / 400 / 600 / 750												
Number of control axes	1-axis	2-axis	3-axis	4-axis	1-axis	2-axis	3-axis	4-axis					
Maximum Connected Axes Output (W)	Max. 800 (When power supply voltage is 200V) Max. 400 (When power supply voltage is 100V)						800	Max. 1600 (When power supply voltage is 200V) Max. 800 (When power supply voltage is 100V)					
Input Voltage	100V Specification: Single-phase AC100 to 115V 200V Specification: Single-phase AC200 to 230V												
Motor Power Input	±10%												
Power Supply Frequency	50Hz/60Hz												
Power Supply Capacity	Max 1670VA		Max 1720VA	Max 1810VA	Max 1670VA	Max 3120VA	Max 3220VA	Max 3310VA					
Position detection method	Incremental Encoder (Serial encoder) Absolute encoder with a rotational data backup (Serial encoder)												
Speed setting	1mm/sec and up, the maximum depends on actuator specifications												
Acceleration setting	0.01G and up, the maximum depends on the actuator												
Programming language	Super SEL language												
Number of programs	64 Programs												
Number of program steps	6,000 Steps (total)												
Number of multi-tasking programs	16 Programs												
Number of Positions	3,000 positions												
Data memory device	FLASH ROM+SRAM Battery Backup												
Data input method	Teaching pendant or PC software												
Standard Input/Output	32 points (total of dedicated inputs + general-purpose inputs) / 16 points (total of dedicated outputs + general-purpose outputs)												
Expansion Input/Output	None	48 points per unit (1 more unit can be installed)						48 points per unit (3 more units can be installed)					
Serial communications function	Teaching Port (25-pin D-sub) Standard Equipment						Teaching Pendant+ Expansion SIO Board Installable (optional)						
Other Input/Output	System I/O (Emergency Stop Input, Enable Input, System Ready Output)												
Protection function	Motor overcurrent, Motor driver temperature check, Overload check, Encoder open-circuit check soft limit over, system error, battery error, etc.												
Ambient Operating Temp./Humidity	Temperature 0 to 40°C, Humidity 30 to 85%												
Ambient atmosphere	Free from corrosive gases. In particular, there shall be no significant dust.												
Weight	2.6kg	3.3kg	5.0kg	6.0kg	7.0kg								
Accessory	I/O Flat Cable												

P (Large-Capacity Standard Type) / Q (Large-Capacity Global Type)

Item	Description												
	P (Standard) Type						Q (Global) Type						
Controller Series, Type	P (Standard) Type / Q (Global) Type												
Connecting actuator	RCS2 / ISA / ISPA / ISP / ISDA / ISDACR / ISPDACR / IF / FS / RS / LSA												
Compatible Motor Output	20 / 30 / 60 / 100 / 150 / 200 / 300 / 400 / 600 / 750												
Number of Controlled Axes	1-axis	2-axis	3-axis	4-axis	5-axis	6-axis	1-axis	2-axis	3-axis	4-axis	5-axis	6-axis	
Maximum Connected Axes Output (W)	Max 2400W (The single-phase AC200V specification is 1600W)												
Control Power Input	Single-phase AC170V to AC253V						Single-phase AC170V to AC253V						
Motor Power Input	Single-phase/3-phase AC180V to AC253V						Single-phase/3-phase AC180V to AC253V						
Power Supply Frequency	50 / 60Hz												
Insulation Resistance	10MΩ or more (between the power-supply terminal and I/O terminals, and between all external terminals and case, at 500VDC)												
Withstand Voltage	AC1500V (1 minute)						AC1500V (1 minute)						
Power Supply Capacity (*1)	Max 1744VA	Max 3266VA	Max 4787VA	Max 4878VA	Max 4931VA	Max 4998VA	Max 1744VA	Max 3266VA	Max 4787VA	Max 4878VA	Max 4931VA	Max 4998VA	
Position detection method	Incremental Encoder (Serial encoder) Absolute encoder with a rotational data backup (Serial encoder)												
Safety Circuit Configuration	Redundancy not supported						Double Redundant Enabled						
Drive Source Breaker System	Internal cutoff relay						External Safety Circuit						
Enable Input	B Contact Input (Internal Power Supply Model)						B Contact Input (External Power Supply Model, Double Redundant)						
Speed setting	1mm/sec and up, the maximum depends on actuator specifications												
Acceleration/Deceleration Setting	0.01G and up, the maximum depends on the actuator												
Programming language	Super SEL language												
Number of programs	128 Programs												
Number of program steps	9999 Steps (total)												
Number of multi-tasking programs	16 Programs												
Number of Positions	20,000 Positions (Total)												
Data memory device	FLASH ROM+SRAM Battery Backup												
Data input method	Teaching pendant or PC software												
Standard Input/Output	48-point I/O PIO Board (NPN/PNP), 96-point I/O PIO Board (NPN/PNP), 1 board can be installed												
Expansion Input/Output	48-point I/O PIO Board (NPN/PNP), 96-point I/O PIO Board (NPN/PNP), Up to 3 boards can be installed												
Serial communications function	Teaching Pendant (25-pin D-sub) Port + 2ch RS232C Port (9-pin D-sub x 2)												
Protection function	Motor overcurrent, overload, motor driver temperature check, overload check encoder open-circuit check, soft limit over, system error, battery error, etc.												
Ambient Operating Temp. Humidity, Atmosphere	0 to 40°C, 10 to 95% (non-condensing). Free from corrosive gases. In particular, there shall be no significant dust.												
Weight (*2)	5.2kg				5.7kg				4.5kg				5kg
Accessory	I/O Flat Cable												

*1 When the connected axes represent the maximum wattage.

*2 Including the absolute-data backup battery, brake mechanism and expansion I/O box.

591 XSEL

External Dimensions

■ J (Compact) Type / K (General Purpose) Type

	1-axis specification	2-axis specification	3/4-axis specification	Side View
J type (Compact Type)				
	1/2-axis specification		3/4-axis specification	
K type (General Purpose Type)				

■ P (high-capacity standard type) / Q (high-capacity global type)

The XSEL-P/Q types have different shapes and dimensions in accordance with the controller specifications (encoder type, with/without brake, and with/without I/O expansion).
The 4 layouts below are available. Confirm dimensions to match the desired type and number of axes.

Caution
The specifications of the single phase 200V in Q type is the exterior dimension of P type.

[P Type]

		Basic Layout (Incremental Specification)	With brake/absolute unit	Basic Layout + I/O expansion base	With brake/absolute unit + I/O expansion base	Side View
Controllers Specifications	Encoder	Incremental	Absolute	Incremental	Absolute	
	Brake	None	Yes	None	Yes	
	I/O	Standard only	Standard only	Standard + Expansion	Standard + Expansion	
Single phase Specifications	1 to 4 axis Specifications					
	5 to 6 axis Specifications					
3 phases Specifications	1 to 4 axis Specifications					
	5 to 6 axis Specifications					

- Slider Type
- Mini
- Standard
- Controllers Integrated
- Pcd Type
- Mini
- Standard
- Controllers Integrated
- Table/Arm /FlatType
- Mini
- Standard
- Gripper/ Rotary Type
- Linear Servo Type
- Cleanroom Type
- Splash-Proo
- Controllers**
- PMEC /AMEC
- PSEP /ASEP
- ROBO NET
- ERC2
- PCON
- ACON
- SCON
- PSEL
- ASEL
- SSEL
- XSEL**
- Pulse Motor
- Servo Motor (24V)
- Servo Motor (200V)
- Linear Servo Motor

External dimensional drawing

[Q Type]

		Basic Layout (Incremental Specification)	With brake/absolute unit	Basic Layout + I/O expansion base	With brake/absolute unit + I/O expansion base	Side View
Controllers Specifications	Encoder	Incremental	Absolute	Incremental	Absolute	
	Brake	None	Yes	None	Yes	
	I/O	Standard only	Standard only	Standard + Expansion	Standard + Expansion	
Single phase Specifications	1 to 4 axis Specifications					<p>Battery Box (Applies to ABS model)</p>
	5 to 6 axis Specifications					
3 phase Specifications	1 to 4 axis Specifications					
	5 to 6 axis Specifications					

593 XSEL

Sold & Serviced By:

ELECTROMATE

Toll Free Phone (877) SERV098

Toll Free Fax (877) SERV099

www.electromate.com

sales@electromate.com

Pulse Motor

Servo Motor
(24V)

Servo Motor
(200V)

Linear
Servo Motor

Slider
Type

Mini

Standard

Controllers
Integrated

Rod
Type

Mini

Standard

Controllers
Integrated

Table/Arm
/FlatType

Mini

Standard

Gripper/
Rotary Type

Linear Servo
Type

Cleanroom
Type

Splash-Proof

Controllers

PMEC
/AMEC

PSEP
/ASEP

ROBO
NET

ERC2

PCON

ACON

SCON

PSEL

ASEL

SSEL

XSEL

Part Names

J type (Compact)

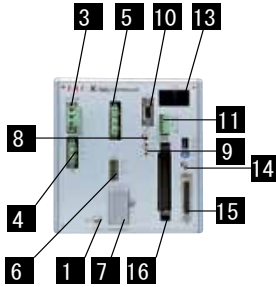

K type (General)

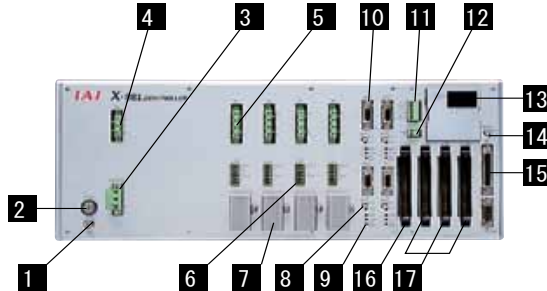

1 FG Connection Terminal

A terminal for connecting to the FG terminal on the enclosure. The PE of the AC input are connected to the enclosure inside the controller.

2 Fuse Holder (K Type only)

This is the single-pole fuse holder for overcurrent protection in the AC input.

3 Main Power Input Connector

This connector is for the AC100/200V single-phase input.

4 Regeneration Resistance Unit Connector

This connector is for the regenerative resistance unit (optional/REU-1) that is connected when there is insufficient capacity with the built-in regenerative resistor for high-acceleration/high-loads, etc.

5 Motor Cable Connector

A connector for the motor power-supply cable of the actuator.

6 Actuator Sensor Input Connector

A connector for axis sensors such as LS, CREEP and OT.

7 Absolute-data backup battery

This is the encoder backup battery unit when an absolute encoder is used. This battery is not connected for a non-absolute axis.

8 Brake Release Switch (Brake-equipped specification only)

Locking toggle switch for releasing the axis brake. Pull the switch forward and then tilt it up or down. Set the switch to the top position (RLS) to forcibly release the brake, or to the bottom position (NOM) to have the brake automatically controlled by the controller.

9 Axis Driver Status LED

This LED is for monitoring the operating status of the driver CPU that controls the motor drive. Features the following three LEDs..

Name	Color	Function description
ALM	Orange	Indicates when an error has been detected by the driver.
SVON	Green	Indicates that the servo is ON and the motor is driven.
BATT ALM	Orange	Indicates low absolute battery charge.

10 Encoder sensor cable connector

15-pin D-sub connector for the actuator encoder cable.

11 System I/O Connector

A connector for three input/output points including two inputs used to for the controller operation, and one system status output.

Name		
EMG	Emergency stop input	ON=operation enabled, OFF=emergency stop
ENB	Safety Gate Input	ON=operation enabled, OFF=servo OFF
RDY	System Ready Relay Output	This signal outputs the status of this controller. Cascade connection is supported. Short=ready, Open=not ready

12 I/O 24V Power Connector (K Type only)

16, **17** This connector is for supplying external I/O power to the insulator when DIs and DOs are installed in the I/O boards.

13 Panel Window

This window has a 4-digit, 7-segment LED and five LED lamps showing the system status.

14 Mode switch

This is a locking toggle switch for designating the controller operating mode. Pull the switch forward and then tilt it up or down.

The top position indicates the MANU (manual operation) mode, while the bottom position indicates the AUTO (automatic operation) mode. Teaching can only be performed in manual operation, and automatic operation using external I/Os is not possible in the MANU mode.

15 Teaching Connector

This is a 25-pin D-sub connector for connecting a teaching pendant or PC cable to enter programmed positions.

16 Standard I/O Slot (Slot 1)

A 32-point input / 16-point output PIO board is installed as standard equipment.

17 Expansion I/O Slots (Slot 2, Slot 3, Slot 4)

Install an expansion I/O board. (Option)

- Slider Type
- Mini
- Standard
- Controllers Integrated
- Pcd Type
- Mini
- Standard
- Controllers Integrated
- Table/Arm /FlatType
- Mini
- Standard
- Gripper/ Rotary Type
- Linear Servo Type
- Cleanroom Type
- Splash-Prod
- Controllers
- PMEC /AMEC
- PSEP /ASEP
- ROBO NET
- ERC2
- PCON
- ACON
- SCON
- PSEL
- ASEL
- SSEL
- XSEL
- Pulse Motor
- Servo Motor (24V)
- Servo Motor (200V)
- Linear Servo Motor

Part Names

Type P (Standard 4-axis)

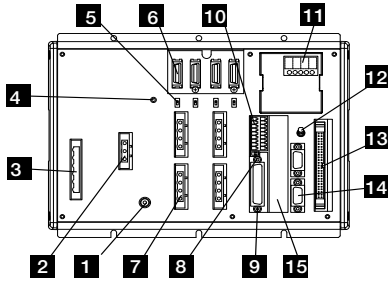

1 FG Connection Terminal

A terminal for connecting to the FG terminal on the enclosure. The PE of the AC input are connected to the enclosure inside the controller.

2 External regeneration unit connector

A connector for the regenerative resistor that must be connected when the built-in regenerative resistor alone does not offer sufficient capacity in high-acceleration/ high-load operation, etc. Whether or not an external regenerative resistor is necessary depends on the conditions of your specific application such as the axis configuration.

3 AC Power Input Connector

AC200V 3-phase input connector. It consists of six terminals including motor power-supply, control power-supply and PE terminals. Standard equipment only includes a terminal block.

Due to risk of electrical shock, do not touch this connector while power is supplied.

4 Control Power Monitor LED

A green light illuminates while the control power supply is properly generating internal controller power.

5 Enable/Disable Switch for Absolute Battery

This switch is for enabling/disabling the encoder backup using the absolute data backup battery. The encoder backup has been disabled prior to shipment. After connecting the encoder/axis-sensor cables, turn on the power, and then set this switch to the top position.

6 Encoder/Axis Sensor Connector

A connector for axis sensors such as LS, CREEP and OT. *: LS, CREEP, and OT are options.

7 Motor connector

A connector for driving the motor in the actuator.

8 Teaching Pendant Type Selection Switch

This switch is for selecting the type of teaching pendant to connect to the teaching connector. Switch between an IAI standard teaching pendant and the ANSI-compatible teaching pendant. Operate the switch on the front face of the board in accordance with the teaching pendant used.

9 Teaching Connector

The teaching interface is used for connecting the IAI teaching pendant or the software on a PC to operate and configure the system, etc.

10 System I/O connector

A connector for managing the safety operation functions of the controllers. Controllers of the global specification let you configure a safety circuit conforming to safety categories of up to 4 using this connector and an external safety circuit.

11 Panel Window

This window consists of a 4-digit, 7-segment LED and five LED lamps showing the system status.

Type Q (Absolute brake unit + expansion base, 6-axis)

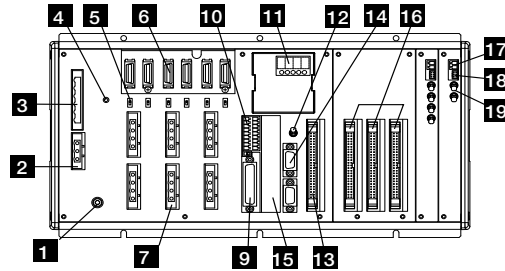

Description of five LEDs

Name	Status when LED is lit
RDY	CPU Ready (programs can be run)
ALM	CPU Power (System Down Level Error) CPU Hardware Problem
EMG	Emergency stop status, CPU hardware problem, or power system hardware problem
PSE	Power supply hardware problem
CLK	System clock problem

12 Mode switch

This is a locking toggle switch for designating the controller operating mode. Pull the switch forward and then tilt it up or down. The top position indicates the MANU (manual operation) mode, while the bottom position indicates the AUTO (automatic operation) mode. Teaching can only be performed in manual operation, and automatic operation using external I/Os is not possible in the MANU mode.

13 Standard I/O connector

50-pin flat connector structure, comprised of 32 input / 16 output DIOs.

Overview of Standard I/O Interface Specifications

Item	Details
Connector Name	I/O
Applicable connector	50-Pins, Flat Connector
Power Supply	Power is supplied through connector pins No. 1 and No. 50.
Input	32 points (including general-purpose and dedicated inputs)
Output	16 points (including general-purpose and dedicated inputs)
Connected to	External PLC, sensors, etc.

14 General-purpose RS232C Port Connector

This port is for connecting general-purpose RS232C equipment. (2-channels are available)

15 Field network board slot

A slot that accepts a fieldbus interface module.

16 Expansion I/O Board (optional)

Slots that accept optional expansion I/O boards.

17 Brake Power Input Connector

A power input connector for driving the actuator brake. DC 24V must be supplied externally. If this power supply is not provided, the actuator brake cannot be released. Be certain that power is supplied to the brake-equipped axis. Use a shielded cable for the brake power cable, and connect the shielding on the 24V power supply side.

18 Brake Release Switch Connector

A connector for the switch that releases the actuator brake externally to the controller. Shorting the COM terminal and BKML* terminal of this connector will release the brake. Use this method if you wish to manually operate the actuator after the controller has experienced a power failure or malfunction.

19 Brake Switch

Locking toggle switch for releasing the axis brake. Pull the switch forward and then tilt it up or down. Setting it to the top position (RLS side) forcibly releases the brake, while setting it to the bottom position (NOM side) causes the controller to automatically control the brake.

595 XSEL

- Slider Type
- Mini
- Standard
- Controllers Integrated
- Pod Type
- Mini
- Standard
- Controllers Integrated
- Table/Arm /FlatType
- Mini
- Standard
- Gripper/ Rotary Type
- Linear Servo Type
- Cleanroom Type
- Splash-Proof
- Controllers
- PMEC /AMEC
- PSEP /ASEP
- ROBO NET
- ERC2
- PCON
- ACON
- SCON
- PSEL
- ASEL
- SSEL
- XSEL
- Pulse Motor
- Servo Motor (24V)
- Servo Motor (200V)
- Linear Servo Motor

Option

Regenerative Resistance Unit

Model **REU-1**

Details

This unit converts to heat the regenerative current produced when the motor decelerates. Although the controller has a built-in regenerative resistor, its capacity may not be enough if the axis is positioned vertically and the load is large. In this case, one or more regenerative units will be required. (Refer to the table at right)

Specifications

Item	Specifications
Main Unit dimensions	W34mm x H195mm x D126mm
Main Unit Weight	900g
Built-in regenerative resistor	220Ω 80W
Accessory	Controller Connection Cable (Model No. CB-ST-REU010) 1m

Installation Standards

Determined by the total motor capacity of vertical axes connected.

Horizontal Application

Number of connecting units	P/Q Type	J Type	K Type
0 pc	to 100W	to 200W	to 800W
1 pc	to 600W	to 800W	to 1200W
2 pc	to 1200W	-	to 1600W
3 pc	to 1800W	-	-
4 pc	to 2400W	-	-

Vertical Application

Number of connecting units	P/Q Type	J Type	K Type
0 pc	to 100W	to 200W	to 400W
1 pc	to 600W	to 600W	to 800W
2 pc	to 1000W	to 800W	to 1200W
3 pc	to 1400W	-	When exceeding 1200W, please contact IAL.
4 pc	to 2000W	-	
5 pc	to 2400W	-	

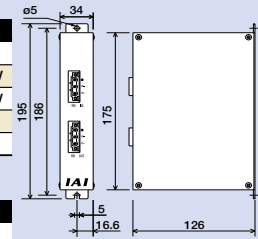

Absolute Data Retention Battery (For XSEL-J/K/KE/KT/KET)

Model **IA-XAB-BT**

Features

A battery that retains the data stored in an absolute type controller.
Replace when the controller battery alarm illuminates.

Packaging

1 Unit (One battery is required for each axis. Specify a quantity for the number of axes used.)



Absolute Data Retention Battery (For XSEL-P/Q)

Model **AB-5**

Features

Absolute data retention battery for operating actuators under absolute specification.



Expansion PIO Board

Details

An optional board for adding I/O (input/output) points. With the general-purpose and large-capacity types, up to three expansion PIO boards can be installed in the expansion slots. (With the compact types, only one expansion PIO board can be installed in the expansion slot, provided that the controller is of 3 or 4-axis specification.)

Expansion SIO Board (General-Purpose Type)

Model/Specifications

IA-105-X-MW-A (for RS232C connection) (Board + joint cables (1), 2 included)
IA-105-X-MW-B (for RS422 connection) (Board + joint cables (2), 1 included)
IA-105-X-MW-C (for RS485 connection) (Board + joint cables (2), 1 included)

Details

Board for serial communications with external equipment. This board has two port channels and implements three communication modes using the supplied joint cable(s).

Joint cable ① Model: CB-ST-232J001

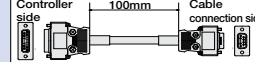

Wiring Diagram

XM2D-1501			XM2A-0901		
Wire	Color	Signal No.	No.Signal	Color	Wire
Orange/Black dot	SD	1	3	SD	Orange/Black dot
Light Gray/Black dot	RD	2	2	RD	Orange/Black dot
Light Gray/Red dot	RS	3	7	RS	Light Gray/Black dot
White/Black dot	CS	4	3	CS	Light Gray/Red dot
White/Black dot	ER	5	4	ER	White/Black dot
White/Red dot	DR	6	8	DR	White/Red dot
Yellow/Black dot	SG	7	5	SG	Yellow/Black dot
		8	1		
		9	9		
		10			
		11			
		12			
		13			
		14			
		15			

* Please provide your own cable to connect to the external equipment

Joint cable ② Model: CB-ST-422J010



Wiring Diagram

XM2D-1501		
Wire	Color	Signal No.
Orange/Black dot	RD+	1
Orange/Red dot	RD-	2
White/Black dot	TRW+	3
Light Gray/Black dot	TRW-	4
Light Gray/Red dot	SD+	5
		6
		7
		8
		9
		10
Orange/Black dot	RD+	11
Orange/Red dot	RD-	12
White/Black dot	TRW+	13
Light Gray/Black dot	TRW-	14
Light Gray/Red dot	SD+	15

* Use by connecting to a terminal block, etc.

DeviceNet Connection Board

A board for connecting the XSEL controller to DeviceNet.

Item	Specifications			
Number of I/O Points	1 board, 256 input points / 256 output points *Only 1 can be installed			
Communication Standard	Interface module certified under DeviceNet 2.0 (certification to be obtained)			
	Group 2 Only Server			
Communication specifications	Insulated node operating on network power supply			
	Master-Slave connection	Bit strobe		
Communication Rate	500k/250k/125kbps (Selectable by DIP switch)			
	Communication Rate	Maximum network length	Maximum branch length	Total branch length
	500 kbps	100m	6m	39m
250 kbps	250m	78m		
125 kbps	500m	156m		
(Note) When a large DeviceNet cable is used				
Communication Power Supply	24VDC (supplied from DeviceNet)			
Low Current Communication Power Supply	60mA or higher			
Number of Reserved Nodes	1 node			
Connector	MSTBA2.5/5-G.08AUM by Phoenix Contact (*1)			

(*1) The connector on the cable (SMSTB2.5/5-ST-5.08AU by Phoenix Contact) is a standard accessory.

CC-Link Connection Board

A board for connecting the XSEL controller to CC-Link.

Item	Specifications					
Number of I/O Points	1 board, 256 input points / 256 output points *Only 1 can be installed					
Communication Standard	CC-Link Ver1.10 (certified)					
Communication Rate	10M/5M/2.5M/625k/156kbps (switched using a rotary switch)					
Communication method	Broadcast polling method					
Asynchronous	Frame synchronization method					
Encoding Format	NRZI					
Transmission path type	Bus Format (EIA RS485 Compliant)					
Transmission Format	HDLC Compliant					
Error control method	CRC (X ¹⁶ +X ¹² +X ⁵ +1)					
Number of Reserved Stations	1 to 3 Stations (Remote Device Stations)					
Communication cable length	Communication Rate (bps)	10M	5M	2.5M	625k	156k
	Communication cable length	100	160	400	900	1200
Connector (Controller-side)	MSTBA2.5/5-G.08AUM by Phoenix Contact (*1)					

(*1) The connector on the cable (SMSTB2.5/5-ST-5.08AU by Phoenix Contact) is a standard accessory.

- Slider Type
- Mini
- Standard
- Controllers Integrated
- Fcd Type
- Mini
- Standard
- Controllers Integrated
- Table/Arm /FlatType
- Mini
- Standard
- Gripper/ Rotary Type
- Linear Servo Type
- Cleanroom Type
- Splash-Proof
- Controllers
- PMEC /AMEC
- PSEP /ASEP
- ROBO NET
- ERC2
- PCON
- ACON
- SCON
- PSEL
- ASEL
- SSEL
- XSEL
- Pulse Motor
- Servo Motor (24V)
- Servo Motor (200V)
- Linear Servo Motor

Part Names

Teaching Pendant

Model IA-T-X (standard)

Dimensions

IA-T-XD (with deadman switch)

- Features**
- A teaching device that has program/position input, test operation, monitoring function, etc.
 - Interactive, easy to operate.
 - For higher safety, a deadman switch version is also available.

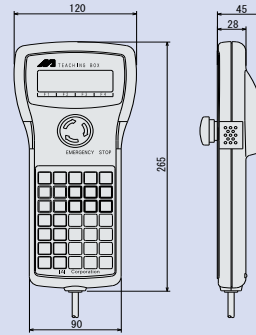

Specifications

Item	Specifications
Ambient Operating Temp./Humidity	Temperature 0 to 40°C, Humidity: 85 %RH or lower
Ambient Operating atmosphere	Free from corrosive gases. In particular, there shall be no significant powder dust.
Weight	Approx. 650g
Cable Length	4m
Indication	20 characters x 4 lines LCD display

Note:

- * Versions older than 1.13 cannot be used with XSEL-P/Q.
- * Versions older than 1.08 cannot be used with SCARA.

ANSI standard / CE mark compatible teaching pendant (dedicated to general purpose type)

Model SEL-T

Dimensions

SEL-TD (Corresponding to ANSI)

SEL-TG (Corresponding to safety category)

- Features**
- Splash-proof type that corresponds to protection level IP54. Improved operability with separate keys for different functions. In addition, SEL-TD / SEL-TG has a 3-position enable switch and corresponds to ANSI standard.

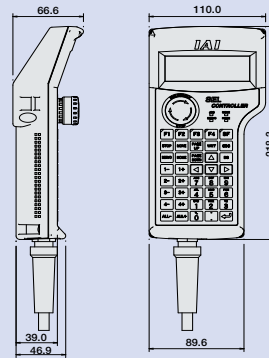

Specifications

Item	Specifications
Ambient Operating Temp./Humidity	Temperature: 0 to 40°C Humidity: 30 to 85%RH or lower (non-condensing)
Protection mechanism	IP54 (Cable connector excluded)
Weight	400g or lower (Cable connector excluded)
Cable Length	5m
Indication	32 characters x 8 lines LCD display
Safety Rating	CE mark, ANSI standard (*)

(*) only SEL-TD / SEL-TG corresponds to ANSI standard.

Teaching pendant controller correspondence table

		IA-T-X	IA-T-XD	SEL-T	SEL-TD	SEL-TG
		Standard	With a deadman switch	Standard	Safety Category Compliant	Safety Category Compliant
Program Controllers	PSEL/ASEL/SSEL	○ (Note 1)	○ (Note 1)	○ (Note 1)	○ (Note 1)	○
	XSEL-J	○	○	×	×	○ (Note 2)
	XSEL-K	○	○	○	○	○
	XSEL-P	○	○	○	○	○
	XSEL-Q	×	×	○	○	○
	XSEL-KT	○	○	○	○	○
	XSEL-KE	○	○	○	○	○
	XSEL-JX	○	○	×	×	○ (Note 2)
	XSEL-KX	○	○	○	○	○
	XSEL-PX	○	○	○	○	○
XSEL-QX	×	×	○	○	○	

* ○ corresponds to safety category B to 4.

○ does not correspond to safety category, but connection is available.

(Note 1) To connect to PSEL/ASEL/SSEL, a conversion cable is necessary.

(Note 2) To connect SEL-TG to the XSEL-J/JX controller, DC24V needs to be applied to TP adaptor.

SEL-TG wiring drawing

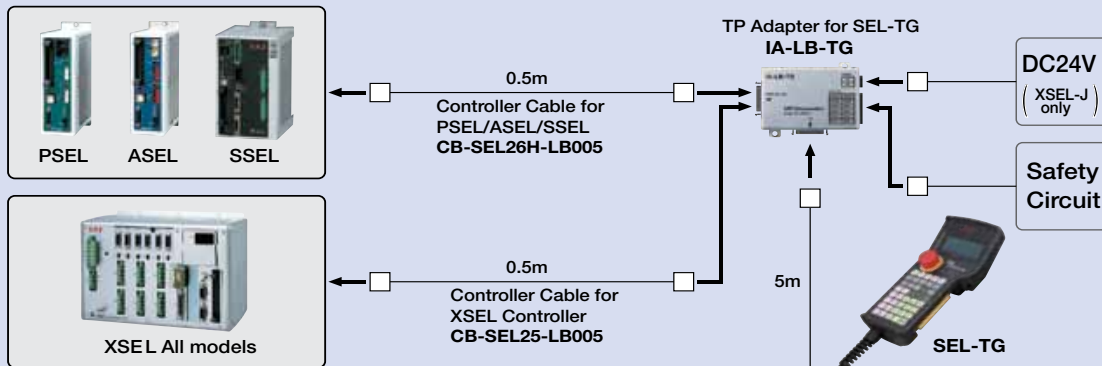

597

XSEL

PC software (Windows dedicated)

Model IA-101-X-MW (DOS/V ver.)

Note:
 * Versions older than 3.0.0 cannot be used with XSEL-P/Q.
 * Versions older than 2.0.0 cannot be used with SCARA.
 * Please use IA-101-XA-MW for safety category 4-compliant controller.

Features A startup support software program offering program/position input function, test operation function, monitoring function, and more.
 The functions needed for debugging have been enhanced to help reduce the startup time.

Details Software (CD-ROM)
 (Corresponding to Windows98, NT, 2000, ME, and XP)
 PC connecting cable 5m + Emergency stop box (Model: CB-ST-E1MW050-EB)

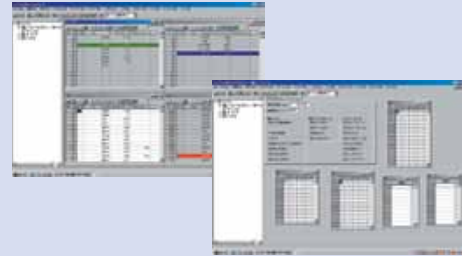

PC connecting cable single unit (Model: CB-ST-E1MW050)

Note:
 When ordering a separate replacement PC cable, the model number for cable only is CB-ST-E1MW050, and for cable with emergency stop box is CB-ST-E1MW050-EB.

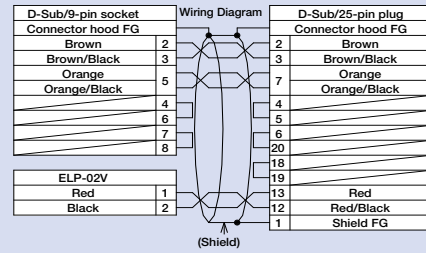
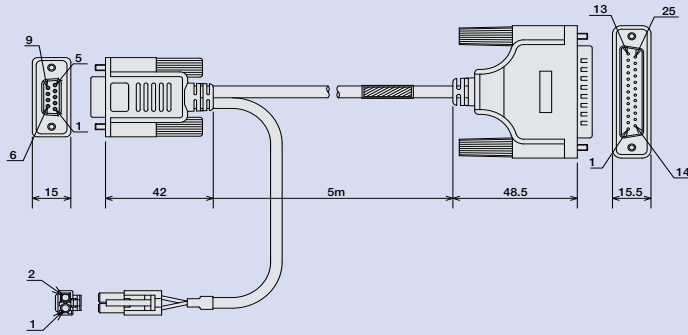

Safety Category 4-compatible PC Software

Model IA-101-XA-MW (DOS/V version)

Features A startup support software program offering program/position input function, test operation function, monitoring function, and more.
 The functions needed for debugging have been enhanced to help reduce the startup time.
 PC connecting cable is compatible to safety category 4 by duplicating the emergency stop circuits.

Details Software (CD-ROM)
 (Accessory) * Corresponding to Windows98, NT, 2000, ME, and XP
 PC connecting cable 5m + Emergency stop box (Model: CB-ST-A1MW050-EB)

Dimensions PC connecting cable (Model: CB-ST-A1MW050)

* Cannot be used with XSEL-J/JX/K/KE/KX/P/PX

Note:
 When ordering a separate replacement PC cable, the model number for cable only is CB-ST-A1MW050, and for cable with emergency stop box is CB-ST-A1MW050-EB.

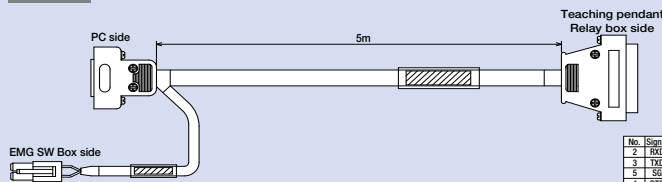

No.	Signal	Color	Wires
2	RXD	Red/Blue	
3	TXD	Gray/Pink	0.25sq
5	SS	Purple/Black	
4	DTR	(short circuit)	0.3sq
6	USB	(short circuit)	
7	RTS	(short circuit)	0.3sq
8	CTS	(short circuit)	
	(Shield)	Connect to case	

No.	Signal	Color	Wires
1	SW1 (NC1)EM2	White	
2	SW1 (NC2)EM1	Brown	0.25sq
3	SW1 (NC1)EM1	Green	
4	SW1 (NC2)EM2	Yellow	

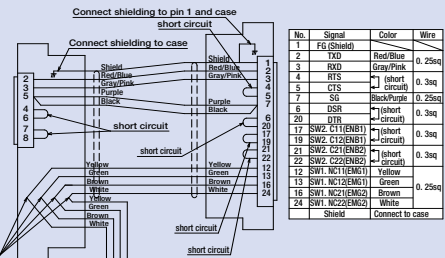

USB-compatible PC software

Model IA-101-X-USBMW

Features Software available by PC USB port by connecting a USB conversion adaptor to a RS232C cable.

Details Software (CD-ROM)
 * Corresponding to Windows98, NT, 2000, ME, and XP
 PC connecting cable 5m + Emergency stop box + USB conversion adaptor + USB cable 3m

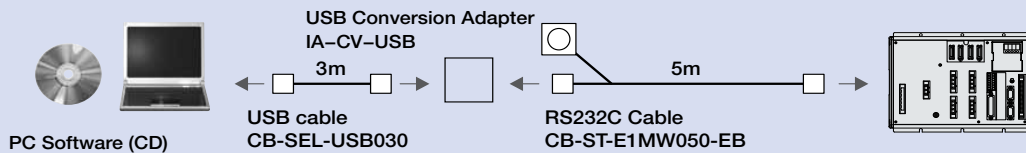

- Slider Type
- Mini
- Standard
- Controllers Integrated
- Pcd Type
- Mini
- Standard
- Controllers Integrated
- Table/Arm /FlatType
- Mini
- Standard
- Gripper/ Rotary Type
- Linear Servo Type
- Cleanroom Type
- Splash-Proof
- Controllers
- PMEC /AMEC
- PSEP /ASEP
- ROBO NET
- ERC2
- PCON
- ACON
- SCON
- PSEL
- ASEL
- SSEL
- XSEL
- Pulse Motor
- Servo Motor (24V)
- Servo Motor (200V)
- Linear Servo Motor

Spare Parts

When you need spare parts after purchasing the product, such as when replacing a cable, refer to the list of models below.

Motor cable/Motor robot cable

Model **CB-RCC-MA** □□□□ / **CB-RCC-MA** □□□□ **-RB**

* Enter the cable length (L) into □□□□. Compatible to a maximum of 20 meters.
Ex.: 080 = 8 m

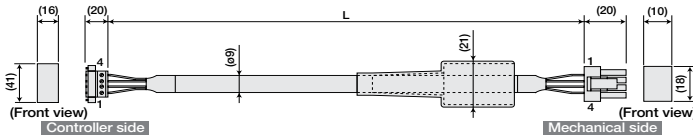

Wire	Signal	No.	No.	Signal	Wire
0.75sq	PE	1	1	U	0.75sq (crimped)
	U	2	2	V	
	V	3	3	W	
	W	4	4	PE	

Min. bend radius $r = 50$ mm or larger (when movable type is used)
* Only the robot cable is to be used in a cable track

Encoder cable/Encoder robot cable (for XSEL-J/K)

Model **CB-RCBC-PA** □□□□ / **CB-RCBC-PA** □□□□ **-RB**

* Enter the cable length (L) into □□□□. Compatible to a maximum of 15 meters.
Ex.: 080 = 8 m

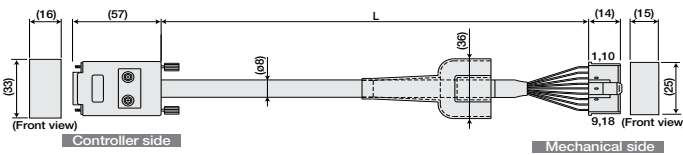

Wire	Signal	No.	No.	Signal	Wire
0.15sq (crimped)	A/U	1	1	A/U	0.15sq (crimped)
	A/U	2	2	A/U	
	B/V	3	3	B/V	
	B/V	4	4	B/V	
	Z/W	5	5	Z/W	
	Z/W	6	6	Z/W	
	SD	7	7	-	
	SD	8	8	-	
	BAT+	9	9	FG	
	BAT-	10	10	SD	
	VCC	11	11	SD	
	GND	12	12	BAT+	
	BK-	13	13	BAT-	
	BK+	14	14	VCC	
	-	15	15	GND	
-	16	16	-		
-	17	17	BK-		
-	18	18	BK+		

The shield is connected to the hood by a clamp.
Ground wire and shield braiding

Min. bend radius $r = 50$ mm or larger (when movable type is used)
* Only the robot cable is to be used in a cable track

Encoder cable/Encoder robot cable (for XSEL-P/Q)

Model **CB-RCS2-PA** □□□□ / **CB-X3-PA** □□□□

* Enter the cable length (L) into □□□□. Compatible to a maximum of 20 meters.
Ex.: 080 = 8 m

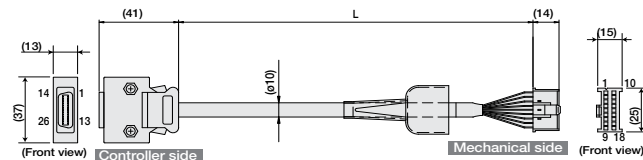

Wire	Color	Signal	No.	No.	Signal	Color	Wire
AWG26 (twisted)	-	-	10	1	A	Pink	AWG26 (crimped)
	-	E2W	12	2	A	Purple	
	Gray/White	BV	13	3	B	White	
	Brown/White	LS	26	4	B	Black/Red	
	-	GREEP	25	5	Z	Orange/White	
	-	OT	24	6	Z	Green/White	
	-	RSW	23	7	LS+	Brown/White	
	-	RSW	9	8	-	-	
	-	-	16	9	FG	Ground	
	-	-	19	10	SD	Blue	
	Pink	A+	1	11	SD	Orange	
	Purple	A-	2	12	BAT+	Black	
	White	B+	3	13	BAT-	Yellow	
	Black/Red	B-	4	14	VCC	Green	
	Orange/White	Z+	5	15	GND	Brown	
	Green/White	Z-	6	16	LS-	Gray/White	
	Blue	SRD+	7	17	BK-	Gray	
	Orange	SRD-	8	18	BK+	Red	
	Black	BAT+	14	-	-	-	
	Yellow	BAT-	15	-	-	-	
	Brown	GND	17	-	-	-	
	Gray	BK-	20	-	-	-	
Red	BK+	21	-	-	-		
-	-	22	-	-	-		

The shield is connected to the hood by a clamp.
Ground wire and shield braiding

Min. bend radius $r = 50$ mm or larger (when movable type is used)
* Only the robot cable is to be used in a cable track

599 XSEL

Spare Parts

Rotary Dedicated Encoder Cable / Encoder Robot Cable

Model **CB-RCS2-PLA** / **CB-X2-PLA**

* Enter the cable length (L) into . Compatible to a maximum of 30 meters.
Ex.: 080 = 8 m

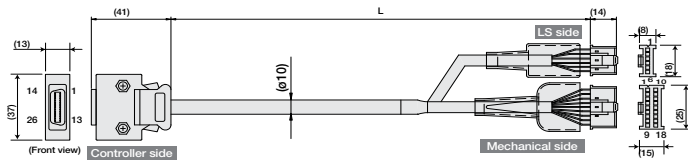

Min. bend radius $r = 50$ mm or larger (when movable type is used)
* Only the robot cable is to be used in a cable track

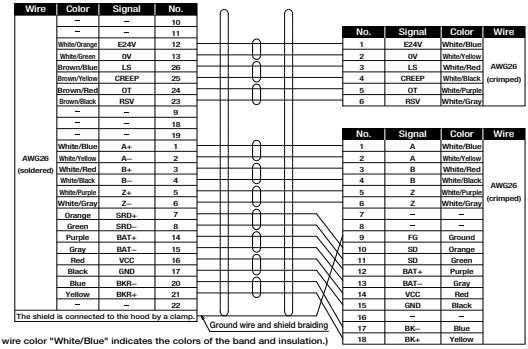

Encoder cable (when using a XSEL-J/K type a homing sensor is used)

Model **CB-RCBC-PLA**

* Enter the cable length (L) into . Compatible to a maximum of 20 meters.
Ex.: 080 = 8 m

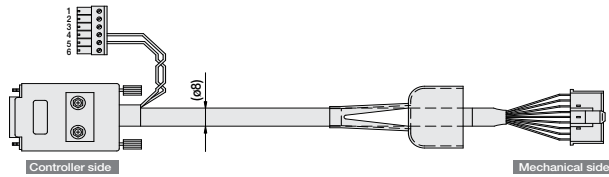

*This cable is a standard type.

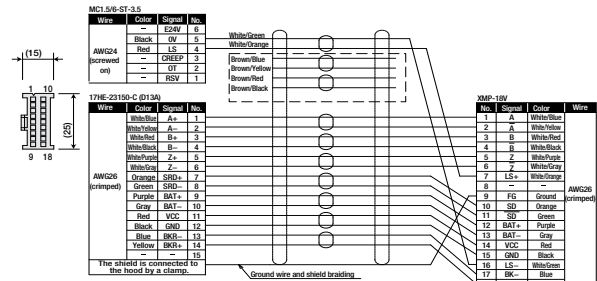

I/O flat cable (for XSEL-J/K/P/Q)

Model **CB-X-PIO**

* Enter the cable length (L) into . Compatible to a maximum of 10 meters.
Ex.: 080 = 8 m

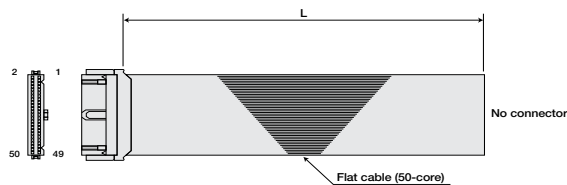

XSEL 600

- Slider Type
- Mini
- Standard
- Controllers Integrated
- Fcd Type
- Mini
- Standard
- Controllers Integrated
- Table/Arm /FlatType
- Mini
- Standard
- Gripper/ Rotary Type
- Linear Servo Type
- Cleanroom Type
- Splash-Proof
- Controllers
- PMEC /AMEC
- PSEP /ASEP
- ROBO NET
- ERC2
- PCON
- ACON
- SCON
- PSEL
- ASEL
- SSEL
- XSEL
- Pulse Motor
- Servo Motor (24V)
- Servo Motor (200V)
- Linear Servo Motor