

Cleanroom Type



Cleanroom Type

ERC3CR
RCP4CR
RCP2CR

RCACR
RCS3CR
RCS2CR

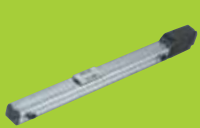

ERC3CR-SA5C

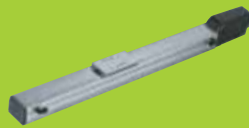

ERC3CR-SA7C



RCP4CR-SA5C



RCP4CR-SA6C



RCP4CR-SA7C

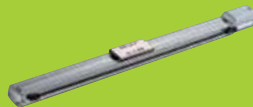

RCP2CR-SS7C

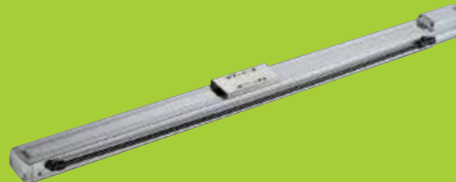

RCP2CR-SS8C

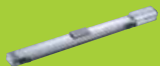

RCACR/RCS2CR
-SA4C



RCACR/RCS2CR
-SA5C

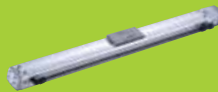

RCACR/RCS2CR
-SA5D



RCS2CR-SA6C

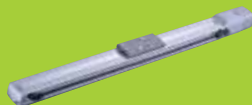

RCS2CR-SS7C

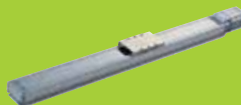

RCS3CR-SA8C

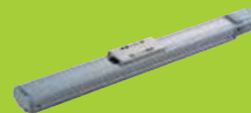

RCS3CR-SS8C

443 Cleanroom Type

ERC3CR series Pulse Motor Type	Slider Type	50mm Width	ERC3CR-SA5C	445
		73mm Width	ERC3CR-SA7C	447

RCP4CR series Pulse Motor Type	Slider Type, Coupled	52mm Width	RCP4CR-SA5C	449
		58mm Width	RCP4CR-SA6C	451
		73mm Width	RCP4CR-SA7C	453

RCP2CR series Pulse Motor Type	Slider Type, Coupled	Steel Base	60mm Width	RCP2CR-SS7C	455	
			80mm Width	RCP2CR-SS8C	457	
	Gripper Type	High-Speed Type	80mm Width	RCP2CR-HS8C	459	
			Mini Slider Type	42mm Width	RCP2CR-GRSS	461
			Mini Lever Type	42mm Width	RCP2CR-GRLS	463

RCACR series 24 Servo Motor Type	Slider Type, Coupled	Aluminum Base	40mm Width	RCACR-SA4C	465
			52mm Width	RCACR-SA5C	467
			58mm Width	RCACR-SA6C	469
	Slider Type, Built-in	Aluminum Base	52mm Width	RCACR-SA5D	471
			58mm Width	RCACR-SA6D	473

RCS3CR series 200V Servo Motor Type	Slider Type, Coupled	Aluminum Base	80mm Width	RCS3CR-SA8C	475
		Steel Base	80mm Width	RCS3CR-SS8C	477

RCS2CR series 200V Servo Motor Type	Slider Type, Coupled	Aluminum Base	40mm Width	RCS2CR-SA4C	479	
			52mm Width	RCS2CR-SA5C	481	
			58mm Width	RCS2CR-SA6C	483	
			73mm Width	RCS2CR-SA7C	485	
	Slider Type, Built-in	Steel Base	60mm Width	RCS2CR-SS7C	487	
			Aluminum Base	52mm Width	RCS2CR-SA5D	489
				58mm Width	RCS2CR-SA6D	491

Slider Type

Mini

Standard

Controllers Integrated

Rod Type

Mini

Standard

Controllers Integrated

Table/Arm/Flat Type

Mini

Standard

Gripper/Rotary Type

Linear Servo Type

Cleanroom Type

Splash-Proof Type

Pulse Motor

Servo Motor (24V)

Servo Motor (200V)

Linear Servo Motor

ERC3CR-SA5C

Cleanroom ROBO Cylinder, Slider Type, Coupled, Actuator Width 50mm, Pulse Motor, Controller-Integrated

Model Specification Items	ERC3CR	SA5C	I	42P	<input type="checkbox"/>	<input type="checkbox"/>	<input type="checkbox"/>	<input type="checkbox"/>	<input type="checkbox"/>	<input type="checkbox"/>
	Series	Type	Encoder type	Motor type	Lead	Stroke	I/O type	Cable length	Controller type	Options
			I: Incremental specification	42□: Pulse motor	20: 20mm 12: 12mm 6: 6mm 3: 3mm	50: 50mm ? : 800: 800mm (50mm pitch increments)	NP: PIO (NPN) type PN: PIO (PNP) type SE: SIO type PLN: Pulse-train (NPN) type PLP: Pulse-train (PNP) type	N: None P: 1m S: 3m M: 5m X□□: Custom Length	CN: CON type MC: MEC type	See Options below.

* See page Pre-47 for details on the model descriptions.

RoHS

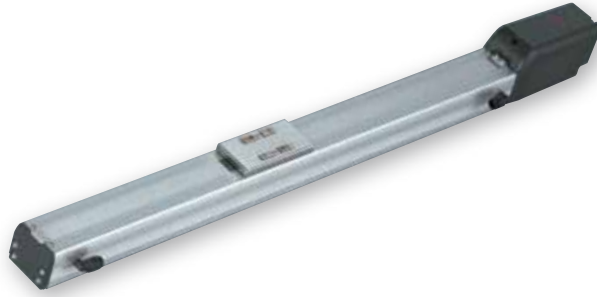

Technical References Appendix P.5

POINT
Notes on selection

- (1) If the high-output setting is enabled (factory default), the duty must be limited. (Refer to page A-95.) If the high-output setting is disabled, the payload and maximum speed become lower, but the actuator can be used at a duty of 100%. Refer to the operation manual for information on how to change the high-output setting.
- (2) Refer to page A-99 for the payload at each speed/acceleration when the high-output setting is enabled.

Speed vs. Load Capacity

Due to the characteristics of the pulse motor, the ERC3 series' load capacity decreases at high speeds. In the table below, check if your desired speed and load capacity are supported.

The values below are based on operation at 0.3 G.

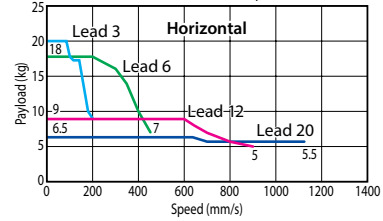

The values below are based on operation at 0.3 G.

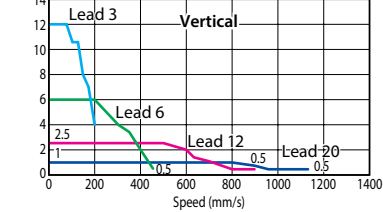

High-output setting enabled (Factory default)

Actuator Specifications (High-output Setting Enabled)

Lead and Payload

(Note 1) Take caution that the maximum payload decreases as the speed increases.

Model number	Lead (mm)	Maximum payload (Note 1)		Stroke (mm)
		Horizontal (kg)	Vertical (kg)	
ERC3CR-SA5C-I-42P-20-①-②-③-④	20	6.5	1	50~800 (every 50mm)
ERC3CR-SA5C-I-42P-12-①-②-③-④	12	9	2.5	
ERC3CR-SA5C-I-42P-6-①-②-③-④	6	18	6	
ERC3CR-SA5C-I-42P-3-①-②-③-④	3	20	12	

Code explanation ① Stroke ② I/O type ③ Cable length ④ Options

Stroke and Max. Speed/Suction Volume by Lead

Stroke Lead	50~450 (every 50mm)	500 (mm)	550 (mm)	600 (mm)	650 (mm)	700 (mm)	750 (mm)	800 (mm)	Suction amount (NL/min)
20	1120	1045	900	785	690	610	80		
12	900	795	665	570	490	425	375	330	50
6	450	395	335	285	245	215	185	165	30
3	225	195	165	140	120	105	90	80	15

* The values of lead 3 apply when acceleration is at 0.1G.

(Unit: mm/s)

① Stroke

Stroke (mm)	Standard price	Stroke (mm)	Standard price
50	—	450	—
100	—	500	—
150	—	550	—
200	—	600	—
250	—	650	—
300	—	700	—
350	—	750	—
400	—	800	—

③ Cable Length

Type	Cable symbol	Standard price	
		PIO type	SIO type
Standard (Robot Cables)	P (1m)	—	—
	S (3m)	—	—
	M (5m)	—	—
Special length	X06 (6m) ~ X10 (10m)	—	—

* See page 586 for cables for maintenance.

④ Options

Name	Option code	See page	Standard price
Brake	B	→ A-42	—
Non-motor end specification	NM	→ A-52	—
Vacuum port on opposite side	VR	→ A-58	—
Simple absolute specification	ABU	→ A-42	— (*)

(*) If the simple absolute specification is selected, the separately sold PIO converter of simple absolute specification (with battery) is required and the SIO type of ERC3 must be selected.

Actuator Specifications

Item	Description
Drive system	Ball screw, ø10mm, rolled C10
Positioning repeatability (*1)	± 0.02mm [± 0.03mm]
Lost motion	0.1mm or less
Allowable static load moment	Ma: 18.6 N·m, Mb: 26.6 N·m, Mc: 47.5 N·m
Allowable dynamic load moment (*2)	Ma: 4.9 N·m, Mb: 6.8 N·m, Mc: 11.7 N·m
Overhang load length	Ma direction: 150mm or less Mb/Mc directions: 150mm or less
Cleanliness	Class 10 (0.1µm)
Ambient operating temperature/humidity	0 to 40°C, 85% RH max. (Non-condensing)

(*1) The specification in [] applies when the lead is 20mm.

(*2) Based on 5,000 km of traveling life.

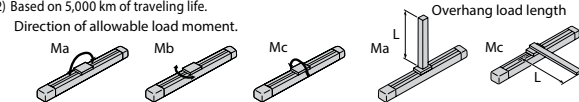

445 ERC3CR-SA5C

Dimensional Drawings

For Special Orders Appendix P.15

- (*1) Connect the power & I/O cable. See page 586 for details on cables.
SE: Stroke End
ME: Mechanical End
- (*2) The slider moves to the ME during home return, so pay attention to possible contact with surrounding structures.
- (*3) Reference position is used when calculating the Ma and Mc moments.

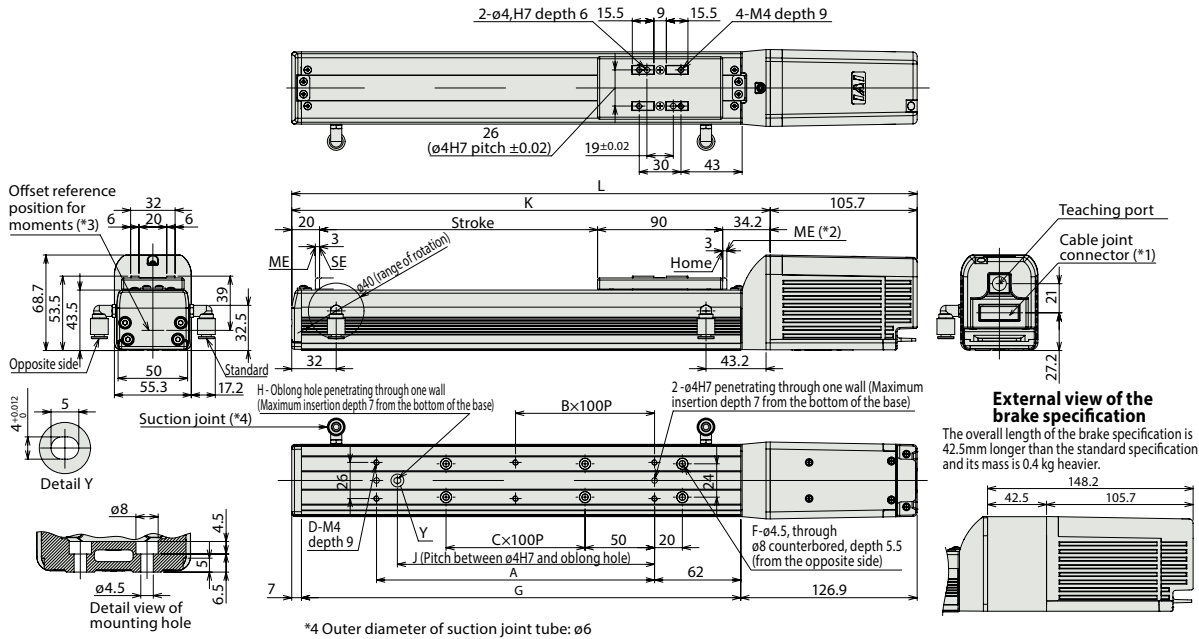

*4 Outer diameter of suction joint tube: $\phi 6$

Dimensions and Weight by Stroke

Stroke	50	100	150	200	250	300	350	400	450	500	550	600	650	700	750	800
L	299.9	349.9	399.9	449.9	499.9	549.9	599.9	649.9	699.9	749.9	799.9	849.9	899.9	949.9	999.9	1049.9
A	73	100	100	200	200	300	300	400	400	500	500	600	600	700	700	800
B	0	0	0	1	1	2	2	3	3	4	4	5	5	6	6	7
C	0	0	1	1	2	2	3	3	4	4	5	5	6	6	7	7
D	4	4	4	6	6	8	8	10	10	12	12	14	14	16	16	18
F	4	4	6	6	6	8	10	10	12	12	14	14	16	16	18	18
G	166	216	266	316	366	416	466	516	566	616	666	716	766	816	866	916
H	0	1	1	1	1	1	1	1	1	1	1	1	1	1	1	1
J	0	85	85	185	185	285	285	385	385	485	485	585	585	685	685	785
K	194.2	244.2	294.2	344.2	394.2	442.2	494.2	544.2	594.2	644.2	694.2	744.2	794.2	844.2	894.2	944.2
Weight (kg)	1.6	1.8	2.0	2.1	2.3	2.5	2.6	2.8	3.0	3.1	3.3	3.5	3.6	3.8	4.0	4.1

Controllers (Built into the Actuator)

I/O type

With the ERC3 series, one of the following five types of built-in controllers can be selected depending on the external input/output (I/O) type. Select the type that meets your purpose.

Name	External view	Model number	Features	Maximum number of positioning points	Input power	Power-supply capacity	Standard price	Reference page
PIO type (NPN specification)		ERC3CR-SA5C-I-42P-□-□-NP-□-□	Simple control type accommodating up to 16 positioning points	16 points	DC24V	High-output setting enabled: 3.5A rated 4.2A max. High-output setting disabled: 2.2A	—	→ P577
PIO type (PNP specification)		ERC3CR-SA5C-I-42P-□-□-PN-□-□	I/O type supporting inputs/outputs of the PNP specification often used overseas	16 points				
SIO type		ERC3CR-SA5C-I-42P-□-□-SE-□-□	High-function type accommodating up to 512 positioning points (PIO converter is used)	512 points				
Pulse-train type (NPN specification)		ERC3CR-SA5C-I-42P-□-□-PLN-□-□	Pulse-train input type supporting the NPN specification	—				
Pulse-train type (PNP specification)		ERC3CR-SA5C-I-42P-□-□-PLP-□-□	Pulse-train input type supporting the PNP specification	—				

IAI

ERC3CR-SA5C

446

Sold & Serviced By:

ELECTROMATE

Toll Free Phone (877) SERV098

Toll Free Fax (877) SERV099

www.electromate.com

sales@electromate.com

Slider Type

Mini

Standard

Controllers Integrated

Rod Type

Mini

Standard

Controllers Integrated

Table/ Arm/ Flat Type

Mini

Standard

Gripper/ Rotary Type

Linear Servo Type

Clean-room Type

Splash-Proof Type

Pulse Motor

Servo Motor (24V)

Servo Motor (200V)

Linear Servo Motor

ERC3CR-SA7C

Cleanroom ROBO Cylinder, Slider Type, Coupled, Actuator Width 73mm, Pulse Motor, Controller-Integrated

Model Specification Items	ERC3CR-SA7C	I	56P							
	Series	Type	Encoder type	Motor type	Lead	Stroke	I/O type	Cable length	Controller type	Options
			I: Incremental specification	56□: Pulse motor	24: 24mm 16: 16mm 8: 8mm 4: 4mm	50: 50mm ? 800: 800mm (50mm pitch increments)	NP: PIO (NPN) type PN: PIO (PNP) type SE: SIO type PLN: Pulse-train (NPN) type PLP: Pulse-train (PNP) type	N: None P: 1m S: 3m M: 5m X□□: Custom Length	CN: CON type MC: MEC type	See Options below.

* See page Pre-47 for details on the model descriptions.



Technical References Appendix P.5

POINT Notes on selection

(1) If the high-output setting is enabled (factory default), the duty must be limited. (Refer to page A-95.) If the high-output setting is disabled, the payload and maximum speed become lower, but the actuator can be used at a duty of 100%. Refer to the operation manual for information on how to change the high-output setting.
 (2) Refer to page A-99 for the payload at each speed/acceleration when the high-output setting is enabled.

Speed vs. Load Capacity

Due to the characteristics of the pulse motor, the ERC3 series' load capacity decreases at high speeds. In the table below, check if your desired speed and load capacity are supported.

The values below are based on operation at 0.3 G.

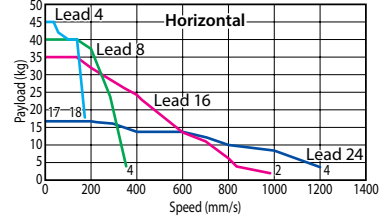

The values below are based on operation at 0.3 G.

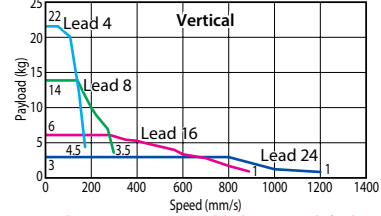

High-output setting enabled (Factory default)

Actuator Specifications (High-output Setting Enabled)

Lead and Payload

(Note 1) Take caution that the maximum payload decreases as the speed increases.

Model number	Lead (mm)	Maximum payload (Note 1)		Stroke (mm)
		Horizontal (kg)	Vertical (kg)	
ERC3CR-SA7C-I-56P-24-①-②-③-④	24	17	3	50~800 (every 50mm)
ERC3CR-SA7C-I-56P-16-①-②-③-④	16	35	6	
ERC3CR-SA7C-I-56P-8-①-②-③-④	8	40	14	
ERC3CR-SA7C-I-56P-4-①-②-③-④	4	45	22	

Code explanation ① Stroke ② I/O type ③ Cable length ④ Options

Stroke and Max. Speed/Suction Volume by Lead

(Unit: mm/s)

Stroke Lead	50~550 (everymm)	600 (mm)	650 (mm)	700 (mm)	750 (mm)	800 (mm)	Suction amount (NL/min)
24	1200	1155	1010	890	790	90	
16	980 <840>	865 <840>	750	655	580	70	
8	490	430	375	325	290	40	
4	210	185	160	145	125	30	

* The values enclosed in < > apply to vertical settings.

* The values of lead 8 and lead 4 apply when acceleration is at 0.1G.

① Stroke

Stroke (mm)	Standard price	Stroke (mm)	Standard price
50	—	450	—
100	—	500	—
150	—	550	—
200	—	600	—
250	—	650	—
300	—	700	—
350	—	750	—
400	—	800	—

③ Cable Length

Type	Cable symbol	Standard price	
		PIO type	SIO type
Standard (Robot Cables)	P (1m)	—	—
	S (3m)	—	—
	M (5m)	—	—
Special length	X06 (6m) ~ X10 (10m)	—	—

* See page 586 for cables for maintenance.

④ Options

Name	Option code	See page	Standard price
Brake	B	→ A-42	—
Non-motor end specification	NM	→ A-52	—
Vacuum port on opposite side	VR	→ A-58	—
Simple absolute specification	ABU	→ A-42	— (*)

(*) If the simple absolute specification is selected, the separately sold PIO converter of simple absolute specification (with battery) is required and the SIO type of ERC3 must be selected.

Actuator Specifications

Item	Description
Drive system	Ball screw, ø12mm, rolled C10
Positioning repeatability (*1)	± 0.02mm [± 0.03mm]
Lost motion	0.1mm or less
Allowable static load moment	Ma: 50.4 N·m, Mb: 71.9 N·m, Mc: 138.0 N·m
Allowable dynamic load moment (*2)	Ma: 13.9 N·m, Mb: 19.9 N·m, Mc: 38.3 N·m
Overhang load length	Ma direction: 230mm or less Mb/Mc directions: 230mm or less
Cleanliness	Class 10 (0.1µm)
Ambient operating temperature/humidity	0 to 40°C, 85% RH max. (Non-condensing)

(*1) The specification in [] applies when the lead is 24mm.

(*2) Based on 5,000 km of traveling life.

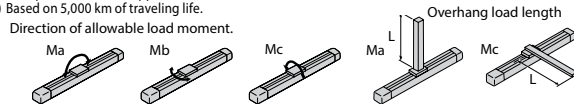

447 ERC3CR-SA7C

For Special Orders Appendix P.15

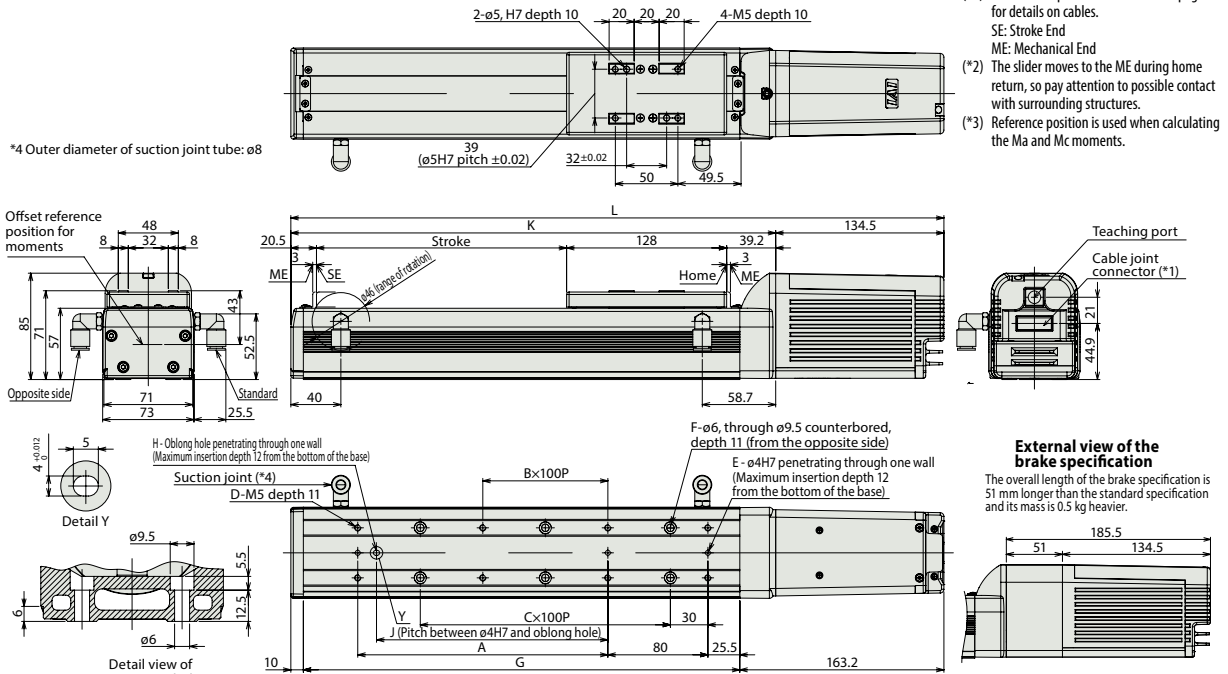

- (*1) Connect the power & I/O cable. See page 586 for details on cables.
SE: Stroke End
ME: Mechanical End
- (*2) The slider moves to the ME during home return, so pay attention to possible contact with surrounding structures.
- (*3) Reference position is used when calculating the Ma and Mc moments.

■ Dimensions and Weight by Stroke

Stroke	50	100	150	200	250	300	350	400	450	500	550	600	650	700	750	800
L	372.2	422.2	472.2	522.2	572.2	622.2	672.2	722.2	772.2	822.2	872.2	922.2	972.2	1022.2	1072.2	1122.2
A	0	100	100	200	200	300	300	400	400	500	500	600	600	700	700	800
B	0	0	0	1	1	2	2	3	3	4	4	5	5	6	6	7
C	1	1	2	2	3	3	4	4	5	5	6	6	7	7	8	8
D	4	6	6	8	8	10	10	12	12	14	14	16	16	18	18	20
E	2	3	3	3	3	3	3	3	3	3	3	3	3	3	3	3
F	4	4	6	6	8	8	10	10	12	12	14	14	16	16	18	18
G	199	249	299	349	399	449	499	549	599	649	699	749	799	849	899	949
H	0	1	1	1	1	1	1	1	1	1	1	1	1	1	1	1
J	0	85	85	185	185	285	285	385	385	485	485	585	585	685	685	785
K	237.7	287.7	337.7	387.7	437.7	487.7	537.7	587.7	637.7	687.7	737.7	787.7	837.7	887.7	937.7	987.7
Weight (kg)	3.6	3.9	4.1	4.4	4.7	4.9	5.2	5.5	6.0	6.0	6.3	6.5	6.8	7.1	7.3	7.6

Controllers (Built into the Actuator)

◎I/O type
With the ERC3 series, one of the following five types of built-in controllers can be selected depending on the external input/output (I/O) type. Select the type that meets your purpose.

Name	External view	Model number	Features	Maximum number of positioning points	Input power	Power-supply capacity	Standard price	Reference page
PIO type (NPN specification)		ERC3CR-SA7C-I-56P-□-□-NP-□-□	Simple control type accommodating up to 16 positioning points	16 points	DC24V	High-output setting enabled: 3.5A rated 4.2A max. High-output setting disabled: 2.2A	—	→ P577
PIO type (PNP specification)		ERC3CR-SA7C-I-56P-□-□-PN-□-□	I/O type supporting inputs/outputs of the PNP specification often used overseas	16 points				
SIO type		ERC3CR-SA7C-I-56P-□-□-SE-□-□	High-function type accommodating up to 512 positioning points (PIO converter is used)	512 points				
Pulse-train type (NPN specification)		ERC3CR-SA7C-I-56P-□-□-PLN-□-□	Pulse-train input type supporting the NPN specification	—				
Pulse-train type (PNP specification)		ERC3CR-SA7C-I-56P-□-□-PLP-□-□	Pulse-train input type supporting the PNP specification	—				



ERC3CR-SA7C 448

- Slider Type
- Mini
- Standard
- Controllers Integrated
- Rod Type
- Mini
- Standard
- Controllers Integrated
- Table/Arm/Flat Type
- Mini
- Standard
- Gripper/Rotary Type
- Linear Servo Type
- Clean-room Type
- Splash-Proof Type
- Pulse Motor
- Servo Motor (24V)
- Servo Motor (200V)
- Linear Servo Motor

RCP4CR-SA5C

Cleanroom ROBO Cylinder, Slider Type, Coupled, Actuator Width 52mm, 24-V Pulse Motor

Model Specification Items: **RCP4CR** — **SA5C** — **I** — **42P** — — — **P3** — —

Series — Type — Encoder type — Motor type — Lead — Stroke — Applicable controller — Cable length — Options

I: Incremental specification 42P: Pulse motor, size 42□ 20: 20mm 50: 50mm P3: PCON-CA N: None See Options below.
 12: 12mm 800: 800mm (50mm pitch increments) MSEP-C P: 1m S: 3m M: 5m X□□: Custom length
 6: 6mm 3: 3mm R□□: Robot cable

* See page Pre-47 for details on the model descriptions.



Technical References Appendix P.5

- POINT** Notes on selection
- The maximum payload is the value when operated at 0.3G (0.2G with some models) acceleration. The upper limit of acceleration is 1 G (*). Note that raising the acceleration causes the payload to drop.
 (*): The specific value varies depending on the connected controller and actuator lead. For details, refer to "Selection References" on page A-100, A-102.
 - Take note that the maximum payload and maximum speed vary depending on the controller connected to the RCP4. (Refer to the actuator specifications below.)
 - See page A-71 for details on push motion.

Speed vs. Load Capacity

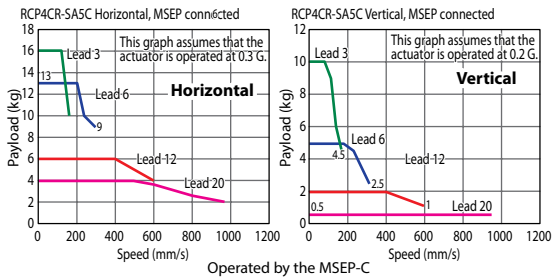
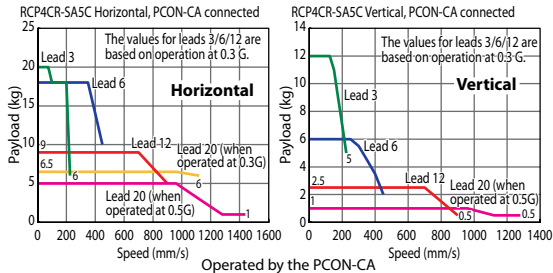

Actuator Specifications

Lead and Payload

(*) When operated at 0.2 G

Model number	Lead (mm)	Connected controller	Maximum payload		Stroke (mm)
			Horizontal (kg)	Vertical (kg)	
RCP4CR-SA5C-I-42P-20-①-P3-②-③	20	PCON-CA	6.5	1	50~800 (every 50mm)
		MSEP-C	4	0.5 (*)	
RCP4CR-SA5C-I-42P-12-①-P3-②-③	12	PCON-CA	9	2.5	
		MSEP-C	6	2	
RCP4CR-SA5C-I-42P-6-①-P3-②-③	6	PCON-CA	18	6	
		MSEP-C	13	5	
RCP4CR-SA5C-I-42P-3-①-P3-②-③	3	PCON-CA	20	12	
		MSEP-C	16	10	

Code explanation ① Stroke ② Cable length ③ Options *See page A-71 for details on push motion.

Stroke and Max. Speed/Suction Volume by Lead

Lead (mm)	Connected controller	50~450 (every 50mm)	500 (mm)	550 (mm)	600 (mm)	650 (mm)	700 (mm)	750 (mm)	800 (mm)	Suction amount (Nl/min)
20	PCON-CA	1440 <1280>	1225	1045	900	785	690	610	80	
	MSEP-C	960		900	785	690	610	80		
12	PCON-CA	900	795	665	570	490	425	375	330	
	MSEP-C	600	490	425	375	330	300	265	230	
6	PCON-CA	450	395	335	285	245	215	185	165	
	MSEP-C	300	285	245	215	185	165	145	125	
3	PCON-CA	225	195	165	140	120	105	90	80	
	MSEP-C	150	140	120	105	90	80	70	60	

The values in < > apply when the actuator is used vertically. (unit: mm/s)

① Stroke

Stroke (mm)	Standard price	Stroke (mm)	Standard price
50	—	450	—
100	—	500	—
150	—	550	—
200	—	600	—
250	—	650	—
300	—	700	—
350	—	750	—
400	—	800	—

② Cable Length

Type	Cable symbol	Standard price
Standard	P (1m)	—
	S (3m)	—
	M (5m)	—
Special length	X06 (6m) ~ X10 (10m)	—
	X11 (11m) ~ X15 (15m)	—
	X16 (16m) ~ X20 (20m)	—
	R01 (1m) ~ R03 (3m)	—
Robot Cable	R04 (4m) ~ R05 (5m)	—
	R06 (6m) ~ R10 (10m)	—
	R11 (11m) ~ R15 (15m)	—
	R16 (16m) ~ R20 (20m)	—
	R21 (21m) ~ R25 (25m)	—

* See page A-59 for cables for maintenance.

③ Options

Name	Option code	See page	Standard price
Brake	B	→ A-42	—
Optional cable exit direction (top)	CJT	→ A-42	—
Optional cable exit direction (right)	CJR	→ A-42	—
Optional cable exit direction (left)	CJL	→ A-42	—
Optional cable exit direction (bottom)	CJB	→ A-42	—
Non-motor end specification	NM	→ A-52	—
Vacuum port on opposite side	VR	→ A-58	—

Actuator Specifications

Item	Description
Drive system	Ball screw, ø10mm, rolled C10
Positioning repeatability (*1)	±0.02mm [±0.03mm]
Lost motion	0.1mm or less
Base	Material: Aluminum with white alumite treated
Allowable dynamic moment (*2)	Ma: 4.9 N-m, Mb: 6.8 N-m, Mc: 11.7 N-m
Allowable overhang	150mm or less in Ma, Mb and Mc directions
Grease	Low dust generation grease (urea grease) is used for both ball screws and guides.
Cleanness	Class 10 (0.1µm)
Ambient operating temperature/humidity	0 to 40°C, 85% RH or less (Non-condensing)

(*1) The value at lead 20 is shown in []. (*2) Based on 5,000 km of traveling life.

449

RCP4CR-SA5C

RCP4CR-SA6C

Cleanroom ROBO Cylinder, Slider Type, Coupled, Actuator Width 58mm, 24-V Pulse Motor

Model Specification Items

RCP4CR — **SA6C** — **I** — **42P** — — — **P3** — —

Series — Type — Encoder type — Motor type — Lead — Stroke — Applicable controller — Cable length — Options

I: Incremental specification 42P: Pulse motor, size 42□ 20: 20mm 50: 50mm P3: PCON-CA N: None See Options below.
 12: 12mm 6: 6mm MSEP-C P: 1m S: 3m M: 5m X□□: Custom length
 3: 3mm 800: 800mm (50mm pitch increments) R□□: Robot cable

* See page Pre-47 for details on the model descriptions.



Technical References **Appendix P.5**

- POINT** Notes on selection
- The maximum payload is the value when operated at 0.3G (0.2G with some models) acceleration. The upper limit of acceleration is 1 G (*). Note that raising the acceleration causes the payload to drop.
 (*): The specific value varies depending on the connected controller and actuator lead. For details, refer to "Selection References" on page A-100, A-102.
 - Take note that the maximum payload and maximum speed vary depending on the controller connected to the RCP4. (Refer to the actuator specifications below.)
 - See page A-71 for details on push motion.

Speed vs. Load Capacity

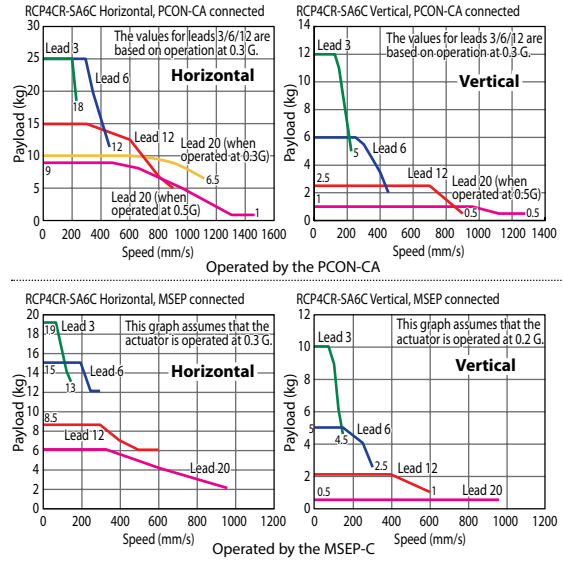

Actuator Specifications

Lead and Payload

(*) When operated at 0.2 G

Model number	Lead (mm)	Connected controller	Maximum payload		Stroke (mm)
			Horizontal (kg)	Vertical (kg)	
RCP4CR-SA6C-I-42P-20-①-P3-②-③	20	PCON-CA	10	1	50~800 (every 50mm)
		MSEP-C	6	0.5 (*)	
RCP4CR-SA6C-I-42P-12-①-P3-②-③	12	PCON-CA	15	2.5	
		MSEP-C	8.5	2	
RCP4CR-SA6C-I-42P-6-①-P3-②-③	6	PCON-CA	25	6	
		MSEP-C	15	5	
RCP4CR-SA6C-I-42P-3-①-P3-②-③	3	PCON-CA	25	12	
		MSEP-C	19	10	

Code explanation ① Stroke ② Cable length ③ Options *See page A-71 for details on push motion.

Stroke and Max. Speed/Suction Volume by Lead

(unit: mm/s)

Lead (mm)	Connected controller	Max. Speed (mm/s)								Suction amount (Nl/min)
		50~450 (every 50mm)	500	550	600	650	700	750	800	
20	PCON-CA	1440<1280>	1230	1045	905	785	690	615	80	
	MSEP-C	960								
12	PCON-CA	900	795	670	570	490	430	375	50	
	MSEP-C	600								
6	PCON-CA	450	395	335	285	245	215	185	30	
	MSEP-C	300								
3	PCON-CA	225	195	165	140	120	105	90	15	
	MSEP-C	150								

The values in <> apply when the actuator is used vertically.

① Stroke

Stroke (mm)	Standard price	Stroke (mm)	Standard price
50	—	450	—
100	—	500	—
150	—	550	—
200	—	600	—
250	—	650	—
300	—	700	—
350	—	750	—
400	—	800	—

② Cable Length

Type	Cable symbol	Standard price
Standard	P (1m)	—
	S (3m)	—
	M (5m)	—
Special length	X06 (6m) ~ X10 (10m)	—
	X11 (11m) ~ X15 (15m)	—
	X16 (16m) ~ X20 (20m)	—
Robot Cable	R01 (1m) ~ R03 (3m)	—
	R04 (4m) ~ R05 (5m)	—
	R06 (6m) ~ R10 (10m)	—
	R11 (11m) ~ R15 (15m)	—
	R16 (16m) ~ R20 (20m)	—

* See page A-59 for cables for maintenance.

③ Options

Name	Option code	See page	Standard price
Brake	B	→ A-42	—
Optional cable exit direction (top)	CJT	→ A-42	—
Optional cable exit direction (right)	CJR	→ A-42	—
Optional cable exit direction (left)	CJL	→ A-42	—
Optional cable exit direction (bottom)	CJB	→ A-42	—
Non-motor end specification	NM	→ A-52	—
Vacuum port on opposite side	VR	→ A-58	—

Actuator Specifications

Item	Description
Drive system	Ball screw, ø10mm, rolled C10
Positioning repeatability (*1)	±0.02mm [±0.03mm]
Lost motion	0.1mm or less
Base	Material: Aluminum with white alumite treated
Allowable dynamic moment (*2)	Ma: 8.9 N-m, Mb: 12.7 N-m, Mc: 18.6 N-m
Allowable overhang	220mm or less in Ma, Mb and Mc directions
Grease	Low dust generation grease (urea grease) is used for both ball screws and guides.
Cleanness	Class 10 (0.1µm)
Ambient operating temperature/humidity	0 to 40°C, 85% RH or less (Non-condensing)

(*1) The value at lead 20 is shown in []. (*2) Based on 5,000 km of traveling life.

451

RCP4CR-SA6C

Dimensional Drawings

For Special Orders Appendix P.15

(*1) Connect the motor-encoder integrated cable here. See page A-59 for details on cables.
 (*2) After homing, the slider moves to the ME, therefore, please watch for any interference with surrounding objects.
 ME: Mechanical end
 SE: Stroke end

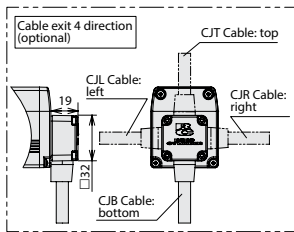
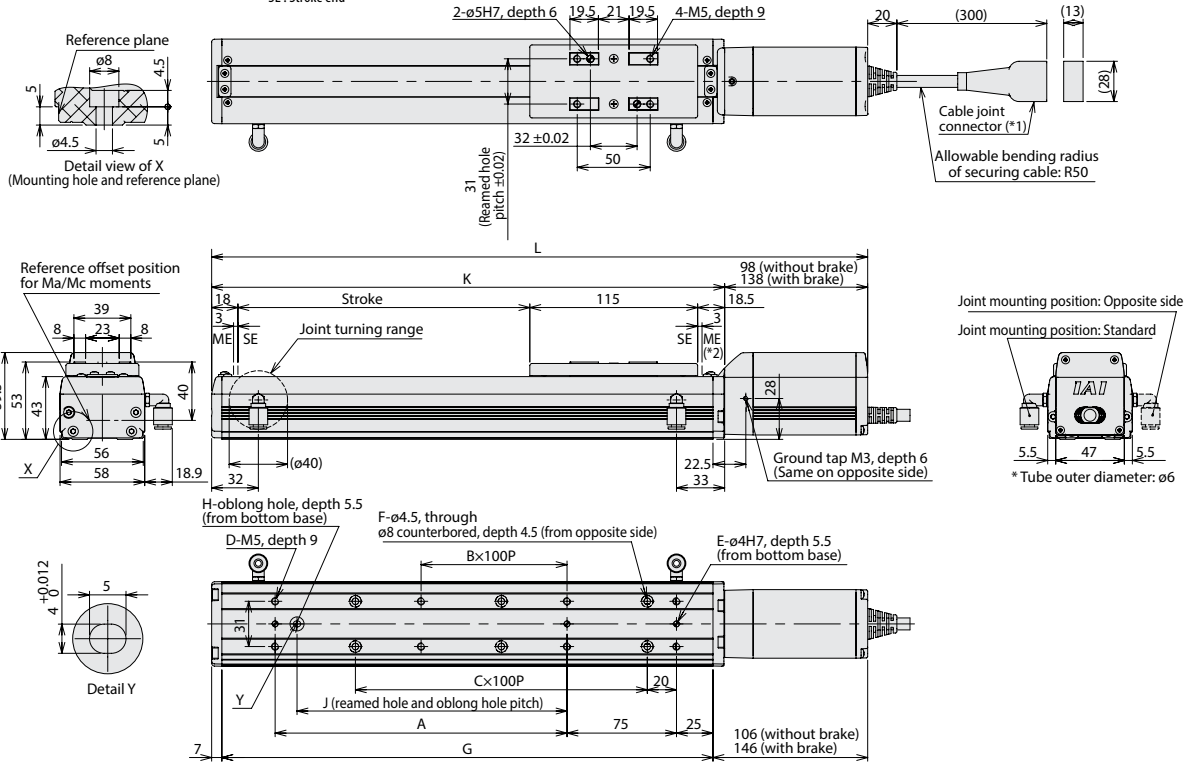

Dimensions and Weight by Stroke

Stroke	50	100	150	200	250	300	350	400	450	500	550	600	650	700	750	800
L Without brake	299.5	349.5	399.5	449.5	499.5	549.5	599.5	649.5	699.5	749.5	799.5	849.5	899.5	949.5	999.5	1049.5
L With brake	339.5	389.5	439.5	489.5	539.5	589.5	639.5	689.5	739.5	789.5	839.5	889.5	939.5	989.5	1039.5	1089.5
A	0	100	100	200	200	300	300	400	400	500	500	600	600	700	700	800
B	0	0	0	1	1	2	2	3	3	4	4	5	5	6	6	7
C	1	1	2	2	3	3	4	4	5	5	6	6	7	7	8	8
D	4	6	6	8	8	10	10	12	12	14	14	16	16	18	18	20
E	2	3	3	3	3	3	3	3	3	3	3	3	3	3	3	3
F	4	4	6	6	8	8	10	10	12	12	14	14	16	16	18	18
G	186.5	236.5	286.5	336.5	386.5	436.5	486.5	536.5	586.5	636.5	686.5	736.5	786.5	836.5	886.5	936.5
H	0	1	1	1	1	1	1	1	1	1	1	1	1	1	1	1
J	0	85	85	185	185	285	285	385	385	485	485	585	585	685	685	785
K	201.5	251.5	301.5	351.5	401.5	451.5	501.5	551.5	601.5	651.5	701.5	751.5	801.5	851.5	901.5	951.5
Weight (kg) Without brake	2.0	2.1	2.3	2.4	2.6	2.7	2.9	3.0	3.2	3.4	3.5	3.7	3.8	4.0	4.1	4.3
Weight (kg) With brake	2.2	2.3	2.5	2.6	2.8	3.0	3.1	3.3	3.4	3.6	3.7	3.9	4.1	4.2	4.4	4.5

Applicable Controllers

RCP4 series actuators can be operated with the controllers indicated below. Select the type according to your intended application.

Name	External view	Model number	Features	Maximum number of positioning points	Input power	Power supply capacity	Standard price	Reference page
Positioner type High-output specification		PCON-CA-42PI-①-2-0	Equipped with a high-output driver PIO control supported	512 points	DC24V	Refer to P618	—	→ P607
Pulse-train type High-output specification		PCON-CA-42PI-PL□-2-0	Equipped with a high-output driver Pulse-train input supported	—				
Field network type High-output specification		PCON-CA-42PI-④-0-0	Equipped with a high-output driver Field network supported	768 points				
Solenoid valve multi-axis type PIO specification	MSEP-C-④-①-①-2-0	Positioner type based on PIO control, allowing up to 8 axes to be connected	3 points					
Solenoid valve multi-axis type Network specification	MSEP-C-④-①-④-0-0	Field network-ready positioner type, allowing up to 8 axes to be connected	256 points					

* ① indicates I/O type (NP/PN). * ② indicates number of axes (1 to 8). * ④ indicates field network specification symbol. * □ indicates N (NPN specification) or P (PNP specification) symbol.

Slider Type

Mini

Standard

Controllers Integrated

Rod Type

Mini

Standard

Controllers Integrated

Table/ Arm/ Flat Type

Mini

Standard

Gripper/ Rotary Type

Linear Servo Type

Clean-room Type

Splash-Proof Type

Pulse Motor

Servo Motor (24V)

Servo Motor (200V)

Linear Servo Motor

RCP4CR-SA7C

Cleanroom ROBO Cylinder, Slider Type, Coupled, Actuator Width 73mm, 24-V Pulse Motor

Model Specification Items

RCP4CR — **SA7C** — **I** — **56P** — — — **P3** — —

Series — Type — Encoder type — Motor type — Lead — Stroke — Applicable controller — Cable length — Options

I: Incremental specification **56P:** Pulse motor, size 56□ 24: 24mm 50: 50mm P3: PCON-CA N: None See Options below.
 16: 16mm 8: 8mm MSEP-C P: 1m S: 3m M: 5m X□□: Custom length
 4: 4mm 800: 800mm (50mm pitch increments) R□□: Robot cable

* See page Pre-47 for details on the model descriptions.



Technical References Appendix P.5

- POINT** Notes on selection
- The maximum payload is the value when operated at 0.3G (0.2G with some models) acceleration. The upper limit of acceleration is 1 G (*). Note that raising the acceleration causes the payload to drop.
 (*The specific value varies depending on the connected controller and actuator lead. For details, refer to "Selection References" on page A-100, A-102.)
 - Take note that the maximum payload and maximum speed vary depending on the controller connected to the RCP4. (Refer to the actuator specifications below.)
 - See page A-71 for details on push motion.

Speed vs. Load Capacity

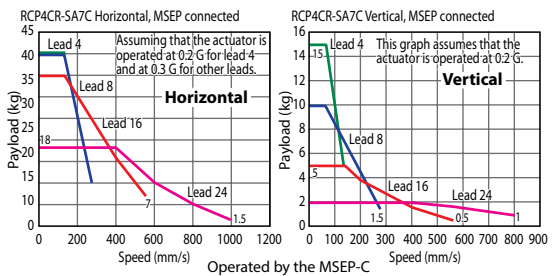
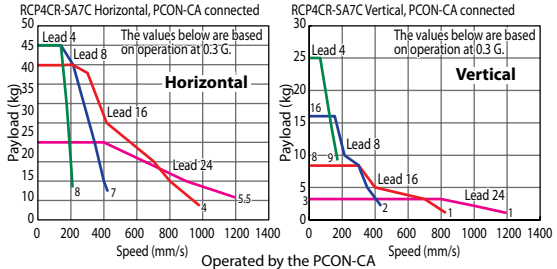

Actuator Specifications

Lead and Payload

(*) When operated at 0.2 G

Model number	Lead (mm)	Connected controller	Maximum payload		Stroke (mm)
			Horizontal (kg)	Vertical (kg)	
RCP4CR-SA7C-I-56P-24-①-P3-②-③	24	PCON-CA	20	3	50~800 (every 50mm)
		MSEP-C	18	2 (*)	
RCP4CR-SA7C-I-56P-16-①-P3-②-③	16	PCON-CA	40	8	
		MSEP-C	35	5 (*)	
RCP4CR-SA7C-I-56P-8-①-P3-②-③	8	PCON-CA	45	16	
		MSEP-C	40	10 (*)	
RCP4CR-SA7C-I-56P-4-①-P3-②-③	4	PCON-CA	45	25	
		MSEP-C	40 (*)	15 (*)	

Code explanation ① Stroke ② Cable length ③ Options *See page A-71 for details on push motion.

Stroke and Max. Speed/Suction Volume by Lead

(unit: mm/s)

Lead (mm)	Connected controller	Max. Speed								Suction amount (Nl/min)
		50~450 (every 50mm)	500 (mm)	550 (mm)	600 (mm)	650 (mm)	700 (mm)	750 (mm)	800 (mm)	
24	PCON-CA	1200								90
	MSEP-C	1000<800>								
16	PCON-CA	980<840>		865<840>	750	655	580	515	70	
	MSEP-C	560								
8	PCON-CA	490		430	375	325	290	255	40	
	MSEP-C	280								
4	PCON-CA	245<210>		215<210>	185	160	145	125	30	
	MSEP-C	140								

The values in <> apply when the actuator is used vertically.

① Stroke

Stroke (mm)	Standard price	Stroke (mm)	Standard price
50	—	450	—
100	—	500	—
150	—	550	—
200	—	600	—
250	—	650	—
300	—	700	—
350	—	750	—
400	—	800	—

② Cable Length

Type	Cable symbol	Standard price
Standard	P (1m)	—
	S (3m)	—
	M (5m)	—
Special length	X06 (6m) ~ X10 (10m)	—
	X11 (11m) ~ X15 (15m)	—
	X16 (16m) ~ X20 (20m)	—
	R01 (1m) ~ R03 (3m)	—
Robot Cable	R04 (4m) ~ R05 (5m)	—
	R06 (6m) ~ R10 (10m)	—
	R11 (11m) ~ R15 (15m)	—
	R16 (16m) ~ R20 (20m)	—

* See page A-59 for cables for maintenance.

③ Options

Name	Option code	See page	Standard price
Brake	B	→ A-42	—
Optional cable exit direction (top)	CJT	→ A-42	—
Optional cable exit direction (right)	CJR	→ A-42	—
Optional cable exit direction (left)	CJL	→ A-42	—
Optional cable exit direction (bottom)	CJB	→ A-42	—
Non-motor end specification	NM	→ A-52	—
Vacuum port on opposite side	VR	→ A-58	—

Actuator Specifications

Item	Description
Drive system	Ball screw, ø12mm, rolled C10
Positioning repeatability (*1)	±0.02mm [±0.03mm]
Lost motion	0.1mm or less
Base	Material: Aluminum with white alumite treated
Allowable dynamic moment (*2)	Ma: 13.9 N·m, Mb: 19.9 N·m, Mc: 38.3 N·m
Allowable overhang	230mm or less in Ma, Mb and Mc directions
Grease	Low dust generation grease (urea grease) is used for both ball screws and guides.
Cleanness	Class 10 (0.1µm)
Ambient operating temperature/humidity	0 to 40°C, 85% RH or less (Non-condensing)

(*1) The value at lead 24 is shown in []. (*2) Based on 5,000 km of traveling life.

453

RCP4CR-SA7C

Dimensional Drawings

For Special Orders Appendix P.15

- (*1) Connect the motor-encoder integrated cable here. See page A-59 for details on cables.
- (*2) After homing, the slider moves to the ME, therefore, please watch for any interference with surrounding objects.
- ME : Mechanical end
- SE : Stroke end

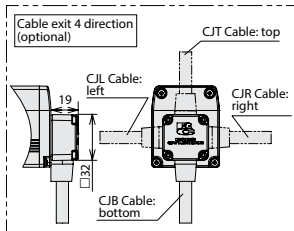
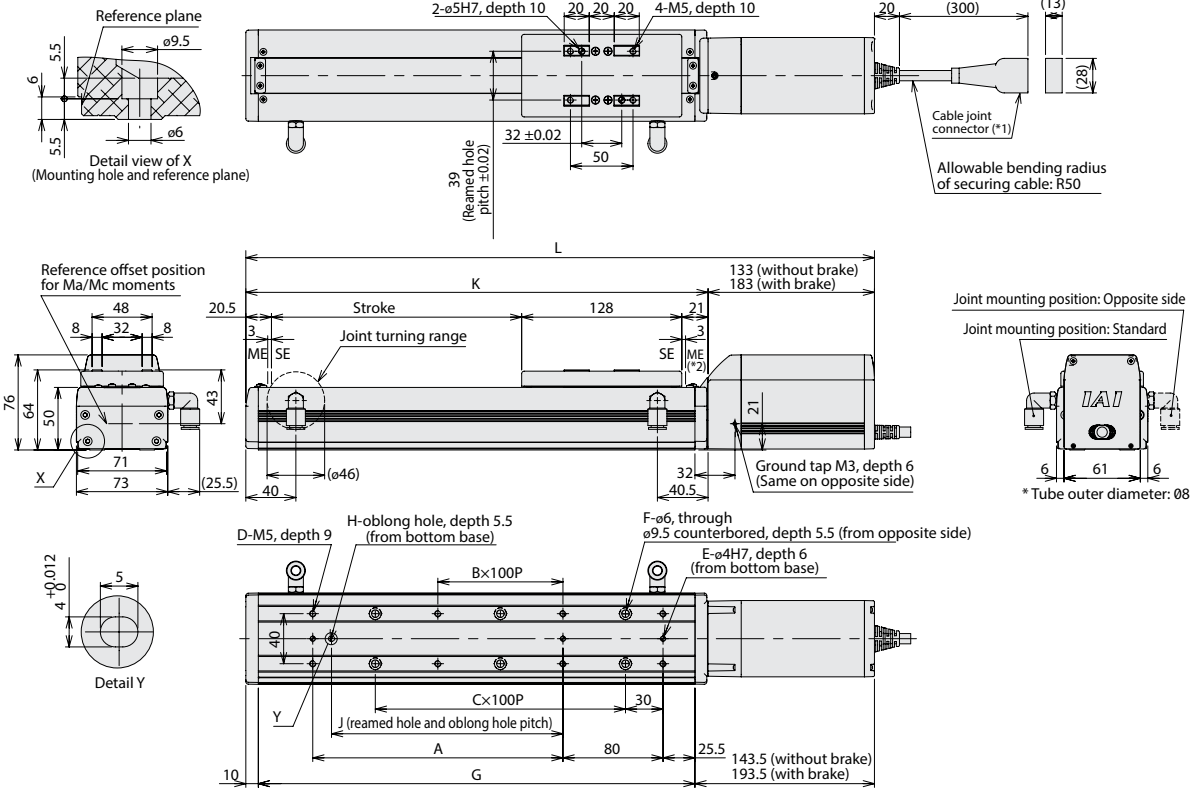

Dimensions and Mass by Stroke

Stroke	50	100	150	200	250	300	350	400	450	500	550	600	650	700	750	800	
L	Without brake	352.5	402.5	452.5	502.5	552.5	602.5	652.5	702.5	752.5	802.5	852.5	902.5	952.5	1002.5	1052.5	1102.5
	With brake	402.5	452.5	502.5	552.5	602.5	652.5	702.5	752.5	802.5	852.5	902.5	952.5	1002.5	1052.5	1102.5	1152.5
A	0	100	100	200	200	300	300	400	400	500	500	600	600	700	700	800	800
B	0	0	0	1	1	2	2	3	3	4	4	5	5	6	6	7	7
C	1	1	2	2	3	3	4	4	5	5	6	6	7	7	8	8	8
D	4	6	6	8	8	10	10	12	12	14	14	16	16	18	18	20	20
E	2	3	3	3	3	3	3	3	3	3	3	3	3	3	3	3	3
F	4	4	6	6	8	8	10	10	12	12	14	14	16	16	18	18	18
G	199	249	299	349	399	449	499	549	599	649	699	749	799	849	899	949	949
H	0	1	1	1	1	1	1	1	1	1	1	1	1	1	1	1	1
J	0	85	85	185	185	285	285	385	385	485	485	585	585	685	685	785	785
K	219.5	269.5	319.5	369.5	419.5	469.5	519.5	569.5	619.5	669.5	719.5	769.5	819.5	869.5	919.5	969.5	969.5
Weight (kg)	Without brake	3.4	3.6	3.8	4.1	4.3	4.6	4.8	5.1	5.3	5.6	5.8	6.0	6.3	6.5	6.8	7.0
	With brake	3.9	4.1	4.3	4.6	4.8	5.1	5.3	5.6	5.8	6.1	6.3	6.5	6.8	7.0	7.3	7.5

Applicable Controllers

RCP4 series actuators can be operated with the controllers indicated below. Select the type according to your intended application.

Name	External view	Model number	Features	Maximum number of positioning points	Input power	Power supply capacity	Standard price	Reference page
Positioner type High-output specification		PCON-CA-56PI-①-2-0	Equipped with a high-output driver PIO control supported	512 points	DC24V	Refer to P618	—	→ P607
Pulse-train type High-output specification		PCON-CA-56PI-PL□-2-0	Equipped with a high-output driver Pulse-train input supported	—				
Field network type High-output specification		PCON-CA-56PI-④-0-0	Equipped with a high-output driver Field network supported	768 points				
Solenoid valve multi-axis type PIO specification	MSEP-C-①-①-①-2-0	Positioner type based on PIO control, allowing up to 8 axes to be connected	3 points					
Solenoid valve multi-axis type Network specification	MSEP-C-①-①-④-0-0	Field network-ready positioner type, allowing up to 8 axes to be connected	256 points	Refer to P572	—	→ P563		

* ① indicates I/O type (NP/PN). * ② indicates number of axes (1 to 8). * ④ indicates field network specification symbol. * □ indicates N (NPN specification) or P (PNP specification) symbol.



RCP4CR-SA7C

454

Sold & Serviced By:



Toll Free Phone (877) SERV098
Toll Free Fax (877) SERV099
www.electromate.com
sales@electromate.com

- Slider Type
- Mini
- Standard
- Controllers Integrated
- Rod Type
- Mini
- Standard
- Controllers Integrated
- Table/Arm/Flat Type
- Mini
- Standard
- Gripper/Rotary Type
- Linear Servo Type
- Clean-room Type
- Splash-Proof Type
- Pulse Motor
- Servo Motor (24V)
- Servo Motor (200V)
- Linear Servo Motor

RCP2CR-SS7C

Cleanroom ROBO Cylinder, Slider Type, Coupled, Actuator Width 60mm, Pulse Motor, Steel Base

Model Specification Items **RCP2CR-SS7C** — **I** — **42P** — [] — [] — [] — [] — []

Series — Type — Encoder type — Motor type — Lead — Stroke — Applicable controller — Cable length — Options

I: Incremental 42P: Pulse motor, 12: 12mm 50: 50mm P1: PCON-PL/PO/SE N: None
 * The Simple absolute encoder is also considered type "I". 42□ size 42□ size 6: 6mm 3: 3mm ? PSEL P: 1m
 P3: PCON-CA PMEC/PSEP M: 5m See Options below.
 X□□: Custom R□□: Robot cable MSEP R□□: Robot cable

* See page Pre-47 for details on the model descriptions.



Technical References Appendix P.5

- POINT** Notes on selection
- (1) When the stroke increases, the maximum speed will drop to prevent the ball screw from reaching the critical rotational speed. Use the actuator specification table below to check the maximum speed at the stroke you desire.
 - (2) Since the RCP2 series use the pulse motor, the load capacity decreases at high speeds. In the Speed vs. Load Capacity graph on the right, see if your desired speed and load capacity are supported.
 - (3) The load capacity is based on operation at an acceleration of 0.3G (0.2G for the 3mm-lead model, or when used vertically). This is the upper limit of the acceleration.
 - (4) See page A-71 for details on push motion.

Speed vs. Load Capacity

Due to the characteristics of the pulse motor, the RCP2 series' load capacity decreases at high speeds. In the table below, check if your desired speed and load capacity are supported.

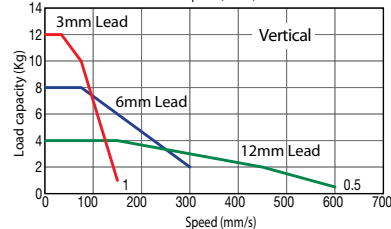
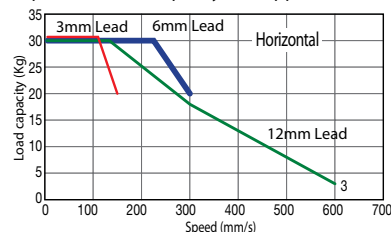

Actuator Specifications

Lead and Payload

(Note 1) Please note that the maximum load capacity decreases as the speed increases.

Model number	Lead (mm)	Max. Load Capacity (Note 1)		Stroke (mm)
		Horizontal (kg)	Vertical (kg)	
RCP2CR-SS7C-I-42P-12-①-②-③-④	12	~30	~4	50~600 (every 50mm)
RCP2CR-SS7C-I-42P-6-①-②-③-④	6	~30	~8	
RCP2CR-SS7C-I-42P-3-①-②-③-④	3	~30	~12	

Stroke and Max. Speed/Suction Volume by Lead

Stroke Lead	50~500 (every 50mm)	~600 (mm)	Suction Volume (NL/min)
12	600	470	50
6	300	230	30
3	150	115	15

Code explanation ① Stroke ② Applicable Controller ③ Cable length ④ Options *See page A-71 for details on push motion. (Unit: mm/s)

① Stroke

① Stroke (mm)	Standard price
50/100	—
150/200	—
250/300	—
350/400	—
450/500	—
550/600	—

③ Cable Length

Type	Cable symbol	Standard price
Standard	P (1m)	—
	S (3m)	—
	M (5m)	—
Special length	X06 (6m) ~ X10 (10m)	—
	X11 (11m) ~ X15 (15m)	—
	X16 (16m) ~ X20 (20m)	—
	R01 (1m) ~ R03 (3m)	—
Robot Cable	R04 (4m) ~ R05 (5m)	—
	R06 (6m) ~ R10 (10m)	—
	R11 (11m) ~ R15 (15m)	—
	R16 (16m) ~ R20 (20m)	—
	—	—

* See page A-59 for cables for maintenance.

④ Options

Name	Option code	See page	Standard price
Brake	B	→ A-42	—
Non-motor end specification	NM	→ A-52	—
Vacuum port on opposite side	VR	→ A-58	—

Actuator Specifications

Item	Description
Drive method	Ball screw, ø10mm, rolled C10
Positioning repeatability	±0.02mm
Lost motion	0.1mm or less
Allowable static moment	Ma: 79.4 N·m, Mb: 79.4 N·m, Mc: 172.9 N·m
Allowable dynamic moment (*)	Ma: 14.7 N·m, Mb: 14.7 N·m, Mc: 33.3 N·m
Overhang load length	Ma direction: 300mm or less Mb/Mc directions: 300mm or less
Grease type	Low dust generation grease (both ball screw and guide)
Cleanliness	Class 10 (0.1µm)
Ambient operating temperature/humidity	0 to 40°C, 85% RH max. (Non-condensing)

(*) Based on 10,000km of traveling life. Direction of allowable load moment.

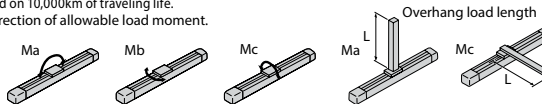

455 RCP2CR-SS7C

Dimensional Drawings

For Special Orders Appendix P.15

- (*1) Connect the motor and encoder cables here. See page A-59 for details on cables.
- (*2) After homing, the slider moves to the ME, therefore, please watch for any interference with surrounding objects.
ME: Mechanical end
SE: Stroke end
The dimensions enclosed in "()" are reference dimensions.
- (*3) Reference position for calculating the moment Ma.

* For the non-motor end model, the dimensions (distance to home) on the motor-side and that on the opposite side are flipped.

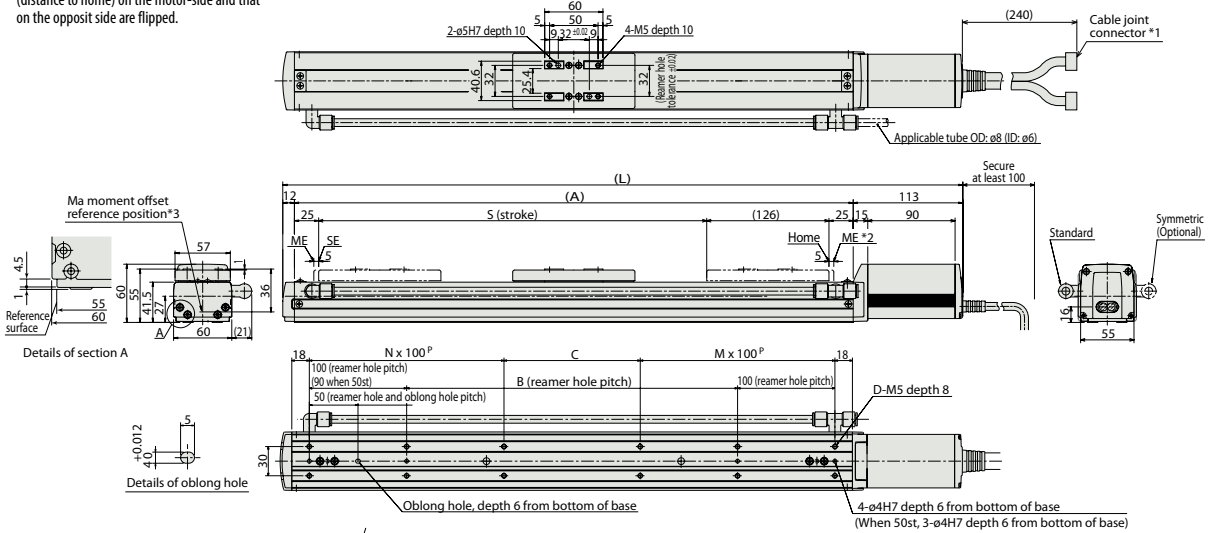

■ Dimensions and Weight by Stroke

Stroke	50	100	150	200	250	300	350	400	450	500	550	600
L	351	401	451	501	551	601	651	701	751	801	851	901
A	226	276	326	376	426	476	526	576	626	676	726	776
B	0	40	90	140	190	240	290	340	390	440	490	540
C	90	40	90	140	190	40	90	140	190	40	90	140
D	6	8	8	8	8	12	12	12	12	16	16	16
M	1	1	1	1	1	2	2	2	2	3	3	3
N	0	1	1	1	1	2	2	2	2	3	3	3
Weight (kg)	3.3	3.6	3.9	4.2	4.6	4.9	5.3	5.6	6.0	6.3	6.6	6.9

② Applicable Controllers

RCP2CR series actuators can be operated with the controllers indicated below. Select the type according to your intended application.

Name	External view	Model number	Features	Maximum number of positioning points	Input power	Power-supply capacity	Standard price	Reference page
Solenoid Valve Type		PMEC-C-42PI-(I)-2-(II)	Easy-to-use controller, even for beginners	3 points	AC100V AC200V	Refer to P541	—	→ P537
		PSEP-C-42PI-(I)-2-0	Simple controller operable with the same signal as a solenoid valve			Refer to P555	—	→ P547
Solenoid valve multi-axis type PIO specification		MSEP-C-(III)~(I)-2-0	Positioner type based on PIO control, allowing up to 8 axes to be connected	256 points	DC24V	Refer to P572	—	→ P563
Solenoid valve multi-axis type Network specification		MSEP-C-(III)~(IV)-0-0	Field network-ready positioner type, allowing up to 8 axes to be connected					
Positioner type High-output specification		PCON-CA-42PI-(I)-2-0	Equipped with a high-output driver Positioner type based on PIO control	512 points	DC24V	Refer to P618	—	→ P607
Pulse-train type High-output specification		PCON-CA-42PI-PL□-2-0	Equipped with a high-output driver Pulse-train input type	(—)				
Field network type High-output specification		PCON-CA-42PI-(IV)-0-0	Equipped with a high-output driver Supporting 7 major field networks	768 points				
Pulse Train Input Type (Differential Line Driver)		PCON-PL-42PI-(I)-2-0	Pulse train input type with differential line driver support	(—)	DC24V	Refer to P628	—	→ P623
Pulse Train Input Type (Open Collector)		PCON-PO-42PI-(I)-2-0	Pulse train input type with open collector support					
Serial Communication Type		PCON-SE-42PI-N-0-0	Dedicated Serial Communication	64 points	DC24V	Refer to P671	—	→ P665
Program Control Type		PSEL-CS-1-42PI-(I)-2-0	Programmed operation is possible. Can operate up to 2 axes	1,500 points	DC24V	Refer to P671	—	→ P665

* This is for the single-axis PSEL. * (I) indicates I/O type (NP/PN). * (II) indicates power supply voltage (1: 100V / 2: 100~240V). * (III) indicates number of axes (1 to 8). * (IV) indicates field network specification symbol. * □ indicates N (NPN specification) or P (PNP specification) symbol.

- Slider Type
- Mini
- Standard
- Controllers Integrated
- Rod Type
- Mini
- Standard
- Controllers Integrated
- Table/Arm/Flat Type
- Mini
- Standard
- Gripper/Rotary Type
- Linear Servo Type
- Clean-room Type
- Splash-Proof Type
- Pulse Motor
- Servo Motor (24V)
- Servo Motor (200V)
- Linear Servo Motor

RCP2CR-SS8C

Cleanroom ROBO Cylinder, Slider Type, Coupled, Actuator Width 80mm, Pulse Motor, Steel Base

Model Specification Items	RCP2CR — SS8C — I — 56P — <input type="checkbox"/> — <input type="checkbox"/> — <input type="checkbox"/> — <input type="checkbox"/> — <input type="checkbox"/>
Series	Type — Encoder type — Motor type — Lead — Stroke — Applicable controller — Cable length — Options
	I: Incremental 56P: Pulse motor, 20: 20mm 50: 50mm P1: PCON-PL/PO/SE N: None P: 1m S: 3m M: 5m X <input type="checkbox"/> : Custom R <input type="checkbox"/> : Robot cable * The Simple absolute encoder is also considered type "I". 56□ size 10: 10mm 5: 5mm 1000: 1000mm (50mm pitch increments) PSEL P3: PCON-CA PMEC/PSEP MSEP See Options below.

* See page Pre-47 for details on the model descriptions.



Technical References Appendix P.5

- POINT** Notes on selection
- When the stroke increases, the maximum speed will drop to prevent the ball screw from reaching the critical rotational speed. Use the actuator specification table below to check the maximum speed at the stroke you desire.
 - Since the RCP2 series use the pulse motor, the load capacity decreases at high speeds. In the Speed vs. Load Capacity graph on the right, see if your desired speed and load capacity are supported.
 - The load capacity is based on operation at an acceleration of 0.3G (0.2G for the 5mm-lead model, or when used vertically). This is the upper limit of the acceleration.
 - See page A-71 for details on push motion.

Speed vs. Load Capacity

Due to the characteristics of the pulse motor, the RCP2 series' load capacity decreases at high speeds. In the table below, check if your desired speed and load capacity are supported.

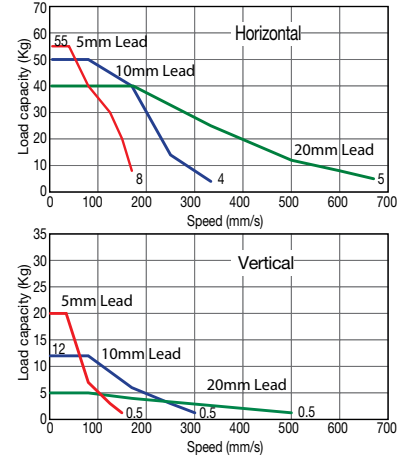

Actuator Specifications

Lead and Payload (Note 1) Please note that the maximum load capacity decreases as the speed increases.

Model number	Lead (mm)	Max. Load Capacity (Note 1)		Stroke (mm)
		Horizontal (kg)	Vertical (kg)	
RCP2CR-SS8C-I-56P-20-①-②-③-④	20	~40	~5	50~1000 (every 50mm)
RCP2CR-SS8C-I-56P-10-①-②-③-④	10	~50	~12	
RCP2CR-SS8C-I-56P-5-①-②-③-④	5	~55	~20	

Stroke and Max. Speed/Suction Volume by Lead (Unit: mm/s)

Lead	Stroke	50~800 (every 50mm)	~900 (mm)	~1000 (mm)	Suction Volume (N ₂ /min)
		20	666 <500>	625 <500>	
10	333 <300>	310 <300>	255	40	
5	165 <150>	155 <150>	125	20	

Code explanation ① Stroke ② Applicable Controller ③ Cable length ④ Options *See page A-71 for details on push motion. *The values enclosed in < > apply to vertical settings.

① Stroke

① Stroke (mm)	Standard price
50/100	—
150/200	—
250/300	—
350/400	—
450/500	—
550/600	—
650/700	—
750/800	—
850/900	—
950/1000	—

④ Options

Name	Option code	See page	Standard price
Brake	B	→ A-42	—
Non-motor end specification	NM	→ A-52	—
Vacuum port on opposite side	VR	→ A-58	—

③ Cable Length

Type	Cable symbol	Standard price
Standard	P (1m)	—
	S (3m)	—
	M (5m)	—
Special length	X06 (6m) ~ X10 (10m)	—
	X11 (11m) ~ X15 (15m)	—
	X16 (16m) ~ X20 (20m)	—
	R01 (1m) ~ R03 (3m)	—
Robot Cable	R04 (4m) ~ R05 (5m)	—
	R06 (6m) ~ R10 (10m)	—
	R11 (11m) ~ R15 (15m)	—
	R16 (16m) ~ R20 (20m)	—

* See page A-59 for cables for maintenance.

Actuator Specifications

Item	Description
Drive method	Ball screw, ø16mm, rolled C10
Positioning repeatability	±0.02mm
Lost motion	0.1mm or less
Allowable static moment	Ma: 198.9 N·m, Mb: 198.9 N·m, Mc: 416.7 N·m
Allowable dynamic moment (*)	Ma: 36.3 N·m, Mb: 36.3 N·m, Mc: 77.4 N·m
Overhang load length	Ma direction: 450mm or less Mb/Mc directions: 450mm or less
Grease type	Low dust generation grease (both ball screw and guide)
Cleanliness	Class 10 (0.1µm)
Ambient operating temperature/humidity	0 to 40°C, 85% RH max. (Non-condensing)

(*) Based on 10,000km of traveling life.

Direction of allowable load moment.

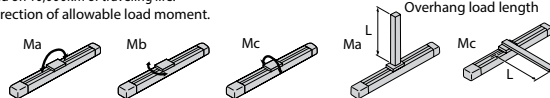

457 RCP2CR-SS8C

Dimensional Drawings

For Special Orders Appendix P.15

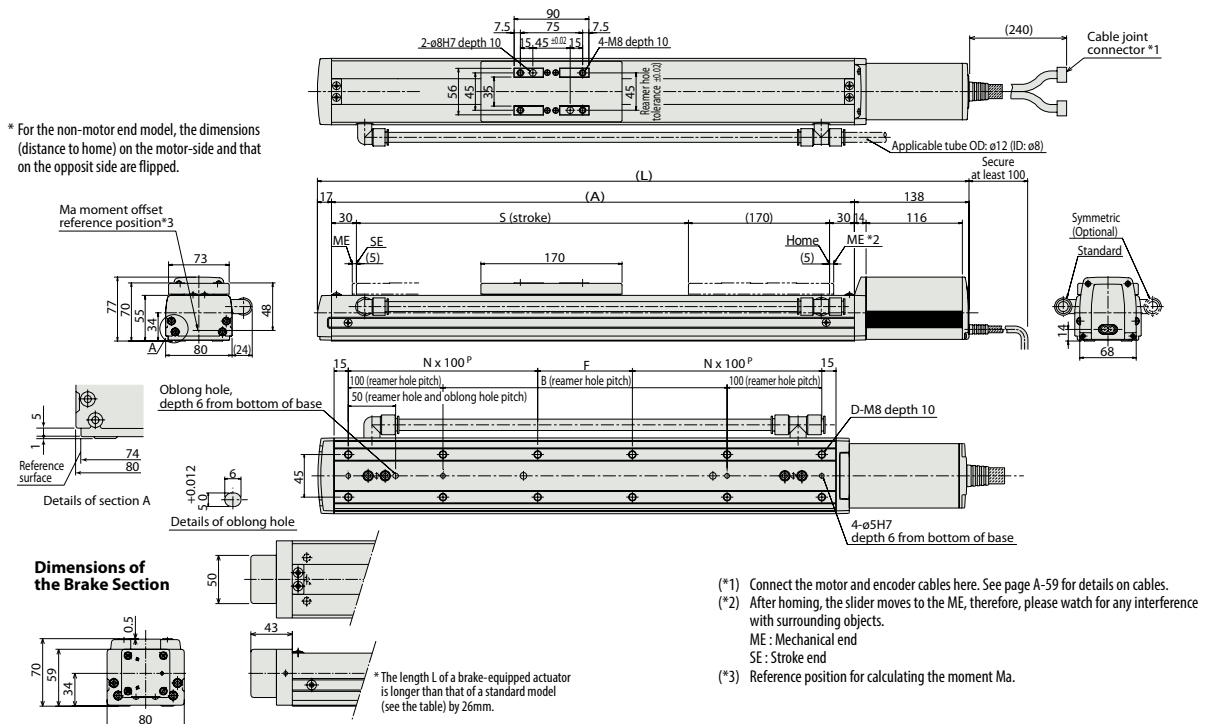

Dimensions and Weight by Stroke

Stroke	50	100	150	200	250	300	350	400	450	500	550	600	650	700	750	800	850	900	950	1000
L	435	485	535	585	635	685	735	785	835	885	935	985	1035	1085	1135	1185	1235	1285	1335	1385
A	280	330	380	430	480	530	580	630	680	730	780	830	880	930	980	1030	1080	1130	1180	1230
B	50	100	150	200	250	300	350	400	450	500	550	600	650	700	750	800	850	900	950	1000
D	8	8	8	10	12	12	12	14	16	16	18	20	20	20	22	24	24	24	24	26
F	50	100	150	0	50	100	150	0	50	100	150	0	50	100	150	0	50	100	150	0
N	1	1	1	2	2	2	2	3	3	3	3	4	4	4	4	5	5	5	5	6
Weight (kg)	7.0	7.5	8.0	8.5	9.0	9.6	10.1	10.6	11.2	11.7	12.3	12.7	13.3	13.8	14.4	14.9	15.4	15.9	16.5	17.0

Applicable Controllers

RCP2CR series actuators can be operated with the controllers indicated below. Select the type according to your intended application.

Name	External view	Model number	Features	Maximum number of positioning points	Input power	Power-supply capacity	Standard price	Reference page
Solenoid Valve Type		PMEC-C-56PI-(I)-2-(II)	Easy-to-use controller, even for beginners	3 points	AC100V AC200V	Refer to P541	—	→ P537
		PSEP-C-56PI-(I)-2-0	Simple controller operable with the same signal as a solenoid valve			Refer to P555	—	→ P547
Solenoid valve multi-axis type PIO specification		MSEP-C-(III)~(I)-2-0	Positioner type based on PIO control, allowing up to 8 axes to be connected	256 points	DC24V	Refer to P572	—	→ P563
Solenoid valve multi-axis type Network specification		MSEP-C-(III)~(IV)-0-0	Field network-ready positioner type, allowing up to 8 axes to be connected				—	→ P607
Positioner type High-output specification		PCON-CA-56PI-(I)-2-0	Equipped with a high-output driver Positioner type based on PIO control	512 points	DC24V	Refer to P618	—	→ P623
Pulse-train type High-output specification		PCON-CA-56PI-PL□-2-0	Equipped with a high-output driver Pulse-train input type	(—)				
Field network type High-output specification		PCON-CA-56PI-(IV)-0-0	Equipped with a high-output driver Supporting 7 major field networks	768 points				
Pulse Train Input Type (Differential Line Driver)		PCON-PL-56PI-(I)-2-0	Pulse train input type with differential line driver support	(—)	DC24V	Refer to P628	—	→ P665
Pulse Train Input Type (Open Collector)		PCON-PO-56PI-(I)-2-0	Pulse train input type with open collector support					
Serial Communication Type		PCON-SE-56PI-N-0-0	Dedicated Serial Communication	64 points	DC24V	Refer to P671	—	→ P665
Program Control Type		PSEL-CS-1-56PI-(I)-2-0	Programmed operation is possible. Can operate up to 2 axes	1,500 points	DC24V	Refer to P671	—	→ P665

* This is for the single-axis PSEL. * (I) indicates I/O type (NP/PN). * (II) indicates power supply voltage (1: 100V / 2: 100~240V).
 * (III) indicates number of axes (1 to 8). * (IV) indicates field network specification symbol. * □ indicates N (NPN specification) or P (PNP specification) symbol.

- Slider Type
- Mini
- Standard
- Controllers Integrated
- Rod Type
- Mini
- Standard
- Controllers Integrated
- Table/ Arm/ Flat Type
- Mini
- Standard
- Gripper/ Rotary Type
- Linear Servo Type
- Clean-room Type
- Splash-Proof Type
- Pulse Motor
- Servo Motor (24V)
- Servo Motor (200V)
- Linear Servo Motor

RCP2CR-HS8C

Cleanroom ROBO Cylinder, High-Speed Slider Type, Coupled, Actuator Width 80mm, Pulse Motor, Steel Base

Model Specification Items	RCP2CR — HS8C — I — 86P — 30 — — P4 — —
Series	Type — Encoder type — Motor type — Lead — Stroke — Applicable controller — Cable length — Options
	I: Incremental 86P: Pulse motor, 56□ high output 30: 30mm 50: 50mm ? 1000: 1000mm (50mm pitch increments) P4: PCON-CFA N: None P: 1m S: 3m M: 5m X□□: Custom length R□□: Robot cable See Options below.

* See page Pre-47 for details on the model descriptions.



Technical References Appendix P.5

- POINT** Notes on selection
- (1) Due to the large lead of the ball screw in high-speed actuators, operating at low speeds may cause vibration and/or noise. Therefore, use the actuator at speeds over 100mm/s.
 - (2) When the stroke increases, the maximum speed will drop to prevent the ball screw from reaching the critical rotational speed. Use the actuator specification table below to check the maximum speed at the stroke you desire.
 - (3) Since the RCP2 series use the pulse motor, the load capacity decreases at high speeds. In the Speed vs. Load Capacity graph on the right, see if your desired speed and load capacity are supported.
 - (4) The load capacity is based on operation at an acceleration of 0.3G (0.2G when used vertically), 0.5G (horizontal) and 0.3G (vertical) are the upper limits of the acceleration.
 - (5) See page A-71 for details on push motion.

Speed vs. Load Capacity

Due to the characteristics of the pulse motor, the RCP2 series' load capacity decreases at high speeds. In the table below, check if your desired speed and load capacity are supported.

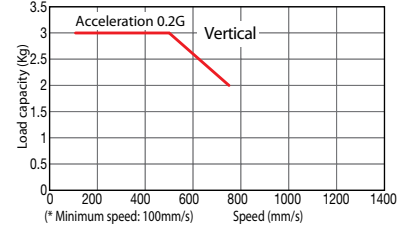
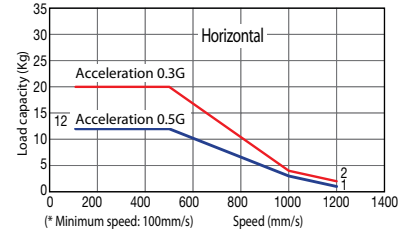

Actuator Specifications

Lead and Payload

(Note 1) Please note that the maximum load capacity decreases as the speed increases.

Model number	Lead (mm)	Max. Load Capacity (Note 1)		Stroke (mm)
		Horizontal (kg)	Vertical (kg)	
RCP2CR-HS8C-I-86P-30-①-P4-②-③	30	~20	~3	50~1000 (every 50mm)

Code explanation ① Stroke ② Cable length ③ Options *See page A-71 for details on push motion.

Stroke and Max. Speed/Suction Volume by Lead

Stroke Lead	50~800 (every 50mm)	~900 (mm)	~1000 (mm)	Suction Volume (Nℓ/min)
30	1200 <750>	1000 <750>	800 <750>	180

*The values enclosed in < > apply to vertical settings.

(Unit: mm/s)

① Stroke

① Stroke (mm)	Standard price
50/100	—
150/200	—
250/300	—
350/400	—
450/500	—
550/600	—
650/700	—
750/800	—
850/900	—
950/1000	—

② Cable Length

Type	Cable symbol	Standard price
Standard	P (1m)	—
	S (3m)	—
	M (5m)	—
Special length	X06 (6m) ~ X10 (10m)	—
	X11 (11m) ~ X15 (15m)	—
	X16 (16m) ~ X20 (20m)	—
	R01 (1m) ~ R03 (3m)	—
Robot Cable	R04 (4m) ~ R05 (5m)	—
	R06 (6m) ~ R10 (10m)	—
	R11 (11m) ~ R15 (15m)	—
	R16 (16m) ~ R20 (20m)	—

* See page A-59 for cables for maintenance.

③ Options

Name	Option code	See page	Standard price
Brake	B	→ A-42	—
Non-motor end specification	NM	→ A-52	—
Vacuum port on opposite side	VR	→ A-58	—

Actuator Specifications

Item	Description
Drive method	Ball screw, ø16mm, rolled C10
Positioning repeatability	±0.02mm
Lost motion	0.1mm or less
Allowable static moment	Ma: 198.9 N·m, Mb: 198.9 N·m, Mc: 416.7 N·m
Allowable dynamic moment (*)	Ma: 36.3 N·m, Mb: 36.3 N·m, Mc: 77.4 N·m
Overhang load length	Ma direction: 450mm or less Mb/Mc directions: 450mm or less
Grease type	Low dust generation grease (both ball screw and guide)
Cleanliness	Class 10 (0.1µm)
Ambient operating temperature/humidity	0 to 40°C, 85% RH max. (Non-condensing)

(*) Based on 10,000km of traveling life.

Direction of allowable load moment.

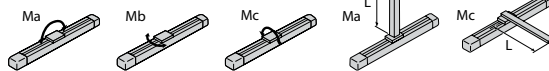

459 RCP2CR-HS8C

Sold & Serviced By:



Toll Free Phone (877) SERV098
Toll Free Fax (877) SERV099
www.electromate.com
sales@electromate.com

- Slider Type
- Mini
- Standard
- Controllers Integrated
- Rod Type
- Mini
- Standard
- Controllers Integrated
- Table/ Arm/ Flat Type
- Mini
- Standard
- Gripper/ Rotary Type
- Linear Servo Type
- Cleanroom Type
- Splash-Proof Type
- Pulse Motor
- Servo Motor (24V)
- Servo Motor (200V)
- Linear Servo Motor

Dimensional Drawings

For Special Orders Appendix P.15

- (*1) A Motor-encoder cable is connected here. See page A-59 for details on cables.
- (*2) After homing, the slider moves to the ME, therefore, please watch for any interference with surrounding objects.
ME : Mechanical end
SE : Stroke end
- (*3) Reference position for calculating the moment Ma.

* For the non-motor end model, the dimensions (distance to home) on the motor-side and that on the opposite side are flipped.

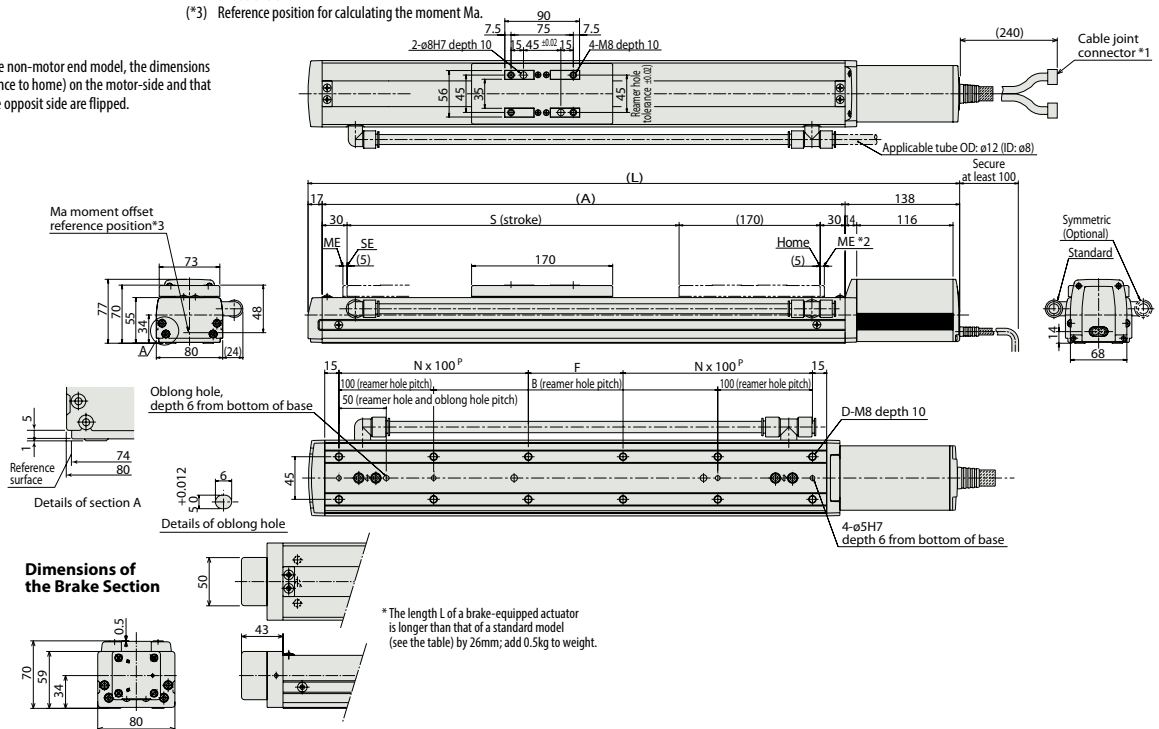

■ Dimensions and Weight by Stroke

Stroke	50	100	150	200	250	300	350	400	450	500	550	600	650	700	750	800	850	900	950	1000
L	435	485	535	585	635	685	735	785	835	885	935	985	1035	1085	1135	1185	1235	1285	1335	1385
A	280	330	380	430	480	530	580	630	680	730	780	830	880	930	980	1030	1080	1130	1180	1230
B	50	100	150	200	250	300	350	400	450	500	550	600	650	700	750	800	850	900	950	1000
D	8	8	8	10	12	12	12	14	16	16	18	20	20	20	20	22	24	24	24	26
F	50	100	150	0	50	100	150	0	50	100	150	0	50	100	150	0	50	100	150	0
N	1	1	1	2	2	2	2	3	3	3	3	4	4	4	4	5	5	5	5	6
Weight (kg)	7.0	7.5	8.0	8.5	9.0	9.6	10.1	10.6	11.2	11.7	12.3	12.7	13.3	13.8	14.4	14.9	15.4	15.9	16.5	17.0

Applicable Controllers

The controller for the RCP2CR-HS8C type is a dedicated controller.

Name	External view	Model number	Features	Maximum number of positioning points	Input power	Power supply capacity	Standard price	Reference page
Positioner Type		PCON-CFA-86PI-①-2-0	Positioning is possible for up to 512 points	512 points	DC24V	6A max.	—	→ P607

* ① indicates I/O type.

Note: • Please note that the encoder cable is a dedicated CFA-type cable. (See page A-59.)
• Note that a simple absolute unit cannot be used.

Slider Type

Mini

Standard

Controllers Integrated

Rod Type

Mini

Standard

Controllers Integrated

Table/ Arm/ Flat Type

Mini

Standard

Gripper/ Rotary Type

Linear Servo Type

Clean-room Type

Splash-Proof Type

Pulse Motor

Servo Motor (24V)

Servo Motor (200V)

Linear Servo Motor

RCP2CR-GRSS

Cleanroom ROBO Cylinder, 2-Finger Gripper, Mini Slider Type, Actuator Width 42mm, Pulse Motor

Model Specification Items	RCP2CR	GRSS	I	20P	30	8	<input type="checkbox"/>	<input type="checkbox"/>	<input type="checkbox"/>
	Series	Type	Encoder type	Motor type	Deceleration Ratio	Stroke	Applicable controller	Cable length	Options
			I: Incremental * The Simple absolute encoder is also considered type "I".	20P: Pulse motor, 20□ size	30: 1/30 deceleration ratio	8: 8mm (4mm per side)	P1: PCON-PL/PO/SE PSEL P3: PCON-CA PMEC/PSEP MSEP	N: None P: 1m S: 3m M: 5m X□□: Custom Length	See Options below.

* See page Pre-47 for details on the model descriptions.



Technical References Appendix P.5

- POINT** Notes on selection
- (1) The maximum opening/closing speed indicates the operating speed on one side. The relative operating speed is twice this value.
 - (2) The maximum gripping force is the sum of the gripping forces of both fingers, at a gripping point where there is no offset or overhang distance. The work piece weight that can be actually moved depends on the friction coefficient between the gripper fingers and the work piece, as well as on the shape of the work piece. As a rough guide, a work piece's weight should not exceed 1/10 to 1/20 of the gripping force. (See page A-86 for details.)
 - (3) The rated acceleration while moving is 0.3G.

Gripping Force vs. Current Limit

The gripping (pushing) force can be adjusted freely within the range of current limits of 20% to 70%.

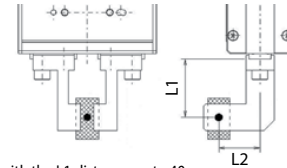

* Operate with the L1 distance up to 40mm.

* The gripping force value in the graph below is when both L1 and L2 are at 0 mm. (For gripping force reference per L1 distance, see page A-87.)

The gripping force value is the sum of gripping forces of both fingers.

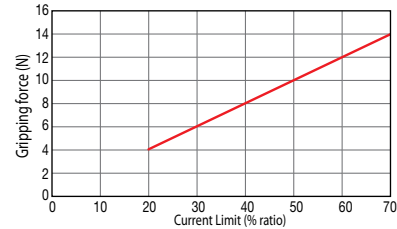

* The gripping force graph above shows the number of references. Please allow margins up to ± 15%.

* Please note that, when gripping (pushing), the speed is fixed at 5mm/s.

Actuator Specifications

Lead and Payload

Model number	Deceleration Ratio	Maximum Gripping Force (N)	Stroke (mm)
RCP2CR-GRSS-I-20P-30-8-①-②-③	30	14 (7 per side)	8 (4 per side)

Code explanation ① Applicable Controller ② Cable length ③ Options

Stroke and Max. Speed/Suction Volume

Deceleration ratio	Stroke	8 (mm)	Suction Volume (Nℓ/min)
	30	78	10

(Unit: mm/s)

Stroke

Stroke (mm)	Standard price
8	—

② Cable Length

Type	Cable symbol	Standard price
Standard (Robot Cables)	P (1m)	—
	S (3m)	—
	M (5m)	—
Special length	X06 (6m) ~ X10 (10m)	—
	X11 (11m) ~ X15 (15m)	—
	X16 (16m) ~ X20 (20m)	—

* The standard cable is the motor-encoder integrated robot cable.

* See page A-59 for cables for maintenance.

③ Options

Name	Option code	See page	Standard price
Non-motor end specification	NM	→ A-52	—
Flange bracket	FB	→ A-43	—
Shaft bracket	SB	→ A-55	—

Actuator Specifications

Item	Description
Drive System	Worm gear + helical gear + helical rack
Positioning repeatability	±0.01mm
Backlash	0.2mm or less per side (constantly pressed out by a spring)
Lost motion	0.05mm or less per side
Guide	Linear guide
Allowable static load moment	Ma: 0.5 N·m, Mb: 0.5 N·m, Mc: 1.5 N·m
Weight	0.2kg
Cleanliness	Class 10 (0.1µm)
Ambient operating temperature, humidity	0 to 40°C, 85% RH or less (Non-condensing)

461 RCP2CR-GRSS

Sold & Serviced By:



Toll Free Phone (877) SERV098
Toll Free Fax (877) SERV099
www.electromate.com
sales@electromate.com

- Slider Type
- Mini
- Standard
- Controllers Integrated
- Rod Type
- Mini
- Standard
- Controllers Integrated
- Table/ Arm/ Flat Type
- Mini
- Standard
- Gripper/ Rotary Type
- Linear Servo Type
- Clean-room Type
- Splash-Proof Type
- Pulse Motor
- Servo Motor (24V)
- Servo Motor (200V)
- Linear Servo Motor

Dimensional Drawings

For Special Orders Appendix P.15

* The opening side of the slider is the home position.
 (*1) Connect the motor-encoder integrated cable here.
 See page A-59 for details on cables.

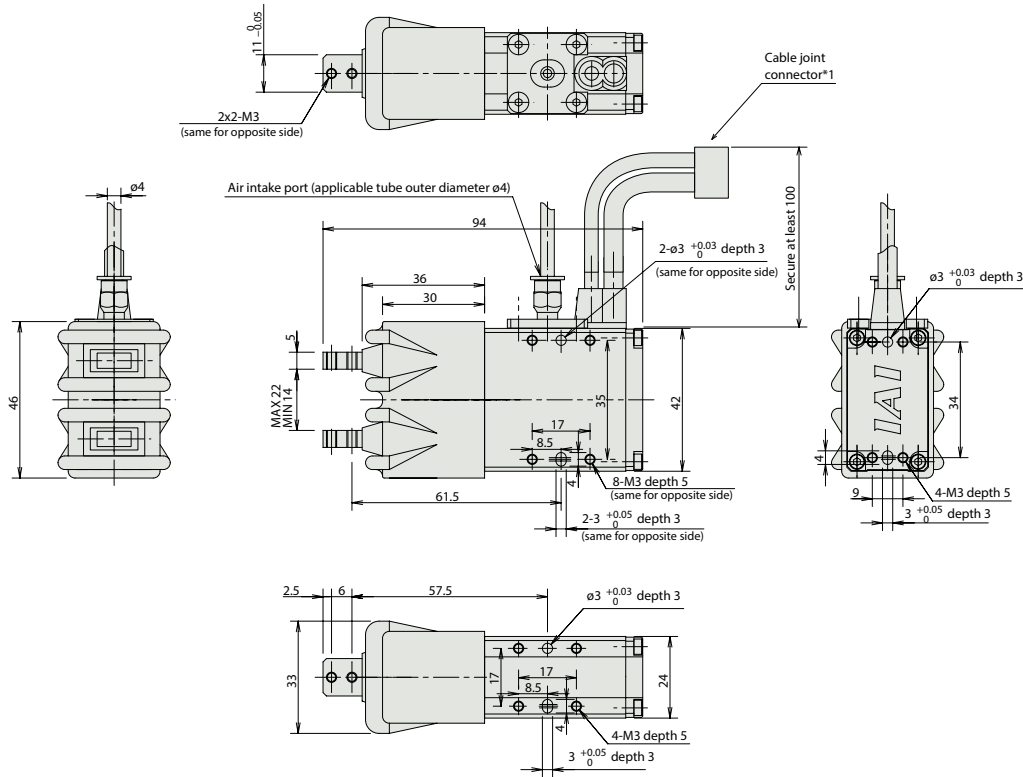

Weight (kg) 0.2

① Applicable Controllers

RCP2CR series actuators can be operated with the controllers indicated below. Select the type according to your intended application.

Name	External view	Model number	Features	Maximum number of positioning points	Input power	Power-supply capacity	Standard price	Reference page	
Solenoid Valve Type		PMEC-C-20PI-①-2-②	Easy-to-use controller, even for beginners	3 points	DC24V	Refer to P541	—	→ P537	
		PSEP-C-20PI-①-2-0	Simple controller operable with the same signal as a solenoid valve			Refer to P555	—	→ P547	
Solenoid valve multi-axis type PIO specification		MSEP-C-③④⑤⑥⑦⑧-①-2-0	Positioner type based on PIO control, allowing up to 8 axes to be connected	256 points		Refer to P572	—	→ P563	
Solenoid valve multi-axis type Network specification		MSEP-C-③④⑤⑥⑦⑧-④-0-0	Field network-ready positioner type, allowing up to 8 axes to be connected						
Positioner type High-output specification		PCON-CA-20PI-①-2-0	Equipped with a high-output driver Positioner type based on PIO control	512 points		DC24V	Refer to P618	—	→ P607
Pulse-train type High-output specification		PCON-CA-20PI-PL□-2-0	Equipped with a high-output driver Pulse-train input type	(—)					
Field network type High-output specification		PCON-CA-20PI-④-0-0	Equipped with a high-output driver Supporting 7 major field networks	768 points					
Pulse Train Input Type (Differential Line Driver)		PCON-PL-20PI-①-2-0	Pulse train input type with differential line driver support	(—)		DC24V	Refer to P628	—	→ P623
Pulse Train Input Type (Open Collector)		PCON-PO-20PI-①-2-0	Pulse train input type with open collector support						
Serial Communication Type		PCON-SE-20PI-N-0-0	Dedicated Serial Communication	64 points		—			
Program Control Type		PSEL-CS-1-20PI-①-2-0	Programmed operation is possible. Can operate up to 2 axes	1,500 points		Refer to P671	—	→ P665	

* This is for the single-axis PSEL. * ① indicates I/O type (NP/PN). * ② indicates power supply voltage (1: 100V / 2: 100~240V). * ③④⑤⑥⑦⑧ indicates number of axes (1 to 8). * ④ indicates field network specification symbol. * □ indicates N (NPN specification) or P (PNP specification) symbol.

IAI

RCP2CR-GRSS 462

Sold & Serviced By: ELECTROMATE

Toll Free Phone (877) SERV098
 Toll Free Fax (877) SERV099
 www.electromate.com
 sales@electromate.com

Slider Type

Mini

Standard

Controllers Integrated

Rod Type

Mini

Standard

Controllers Integrated

Table/ Arm/ Flat Type

Mini

Standard

Gripper/ Rotary Type

Linear Servo Type

Clean-room Type

Splash-Proof Type

Pulse Motor

Servo Motor (24V)

Servo Motor (200V)

Linear Servo Motor

RCP2CR-GRLS

Cleanroom ROBO Cylinder, 2-Finger Gripper, Mini Lever Type, Actuator Width 42mm, Pulse Motor

Model Specification Items	RCP2CR — GRLS — I — 20P — 30 — 180 —	Applicable controller	Cable length	Options
	Series — Type — Encoder type — Motor type — Deceleration Ratio — Stroke	P1: PCON-PL/PO/SE PSEL P3: PCON-CA PMEC/PSEP MSEP	N: None P: 1m S: 3m M: 5m X□□: Custom Length	See Options below.
	I: Incremental * The Simple absolute encoder is also considered type "I".	20P: Pulse motor, 20□ size	30: 1/30 deceleration ratio	180: 180 degrees (90 degrees per side)

* See page Pre-47 for details on the model descriptions.



Technical References Appendix P.5



- The maximum opening/closing speed indicates the operating speed on one side. The relative operating speed is twice this value.
- The maximum gripping force is the sum of the gripping forces of both fingers, at a gripping point where there is no offset or overhanging distance. The work piece weight that can be actually moved depends on the friction coefficient between the gripper fingers and the work piece, as well as on the shape of the work piece. As a rough guide, a work piece's weight should not exceed 1/10 to 1/20 of the gripping force. (See page A-86 for details.)
- The rated acceleration while moving is 0.3G.

Gripping Force vs. Current Limit

The gripping (pushing) force can be adjusted freely within the range of current limits of 20% to 70%.

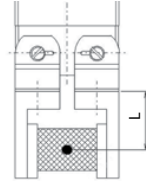

* The gripping force of the graph below is measured on the top face of the lever. The actual gripping force drops in inverse proportion to the distance from the opening/closing fulcrum. Calculate the effective gripping force using the formula below.

$$\text{Effective gripping force (GRLS)} = F \times 15.5 / (L + 15.5)$$

* In the graph below, the gripping force value is the sum of gripping forces of both fingers.

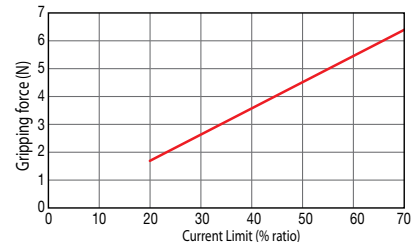

* The gripping force graph above shows the number of references. Please allow margins up to ± 15%.

* Please note that, when gripping (pushing), the speed is fixed at 5 deg/s.

Actuator Specifications

Lead and Payload

Model number	Deceleration Ratio	Maximum Gripping Force (N)	Stroke (deg)
RCP2CR-GRLS-I-20P-30-180-①-②-③	30	6.4 (3.2 per side)	180 (90 per side)

Code explanation ① Applicable Controller ② Cable length ③ Options

Deceleration Ratio and Max. Speed

Stroke / Deceleration ratio	180 (deg)
30	600

(Unit: degrees/s)

Stroke

Stroke (deg)	Standard price
180	—

② Cable Length

Type	Cable symbol	Standard price
Standard (Robot Cables)	P (1m)	—
	S (3m)	—
	M (5m)	—
Special length	X06 (6m) ~ X10 (10m)	—
	X11 (11m) ~ X15 (15m)	—
	X16 (16m) ~ X20 (20m)	—

* The standard cable is the motor-encoder integrated robot cable.
* See page A-59 for cables for maintenance.

③ Options

Name	Option code	See page	Standard price
Non-motor end specification	NM	→ A-52	—
Flange bracket	FB	→ A-43	—
Shaft bracket	SB	→ A-55	—

Actuator Specifications

Item	Description
Drive System	Worm gear + helical gear
Positioning repeatability	±0.01mm
Backlash	1 degree or less per side (constantly pressed out by a spring)
Lost motion	0.1mm or less per side
Guide	—
Allowable static load moment	—
Weight	0.2kg
Ambient operating temperature, humidity	0 to 40°C, 85% RH or less (Non-condensing)

463

RCP2CR-GRLS



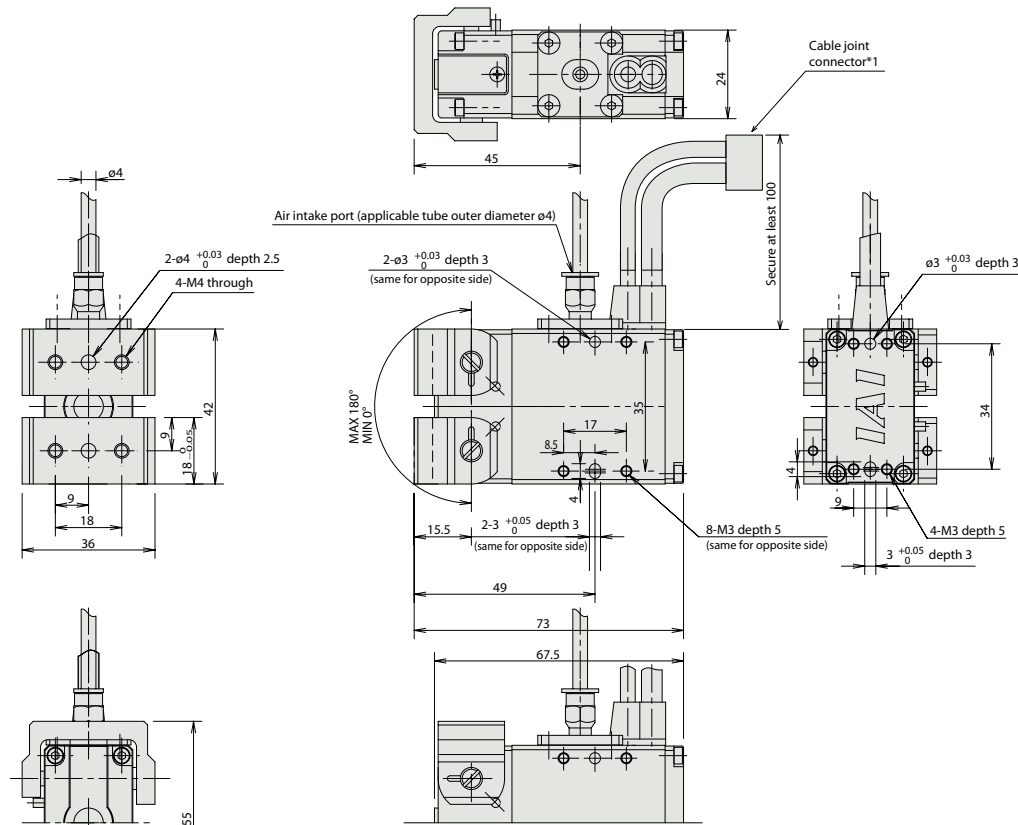



* The opening side of the slider is the home position.
 (*1) Connect the motor-encoder integrated cable here.
 See page A-59 for details on cables.



Weight (kg) 0.2

① Applicable Controllers

RCP2CR series actuators can be operated with the controllers indicated below. Select the type according to your intended application.

Name	External view	Model number	Features	Maximum number of positioning points	Input power	Power-supply capacity	Standard price	Reference page
Solenoid Valve Type		PMEC-C-20PI-①-2-②	Easy-to-use controller, even for beginners	3 points	DC24V	Refer to P541	—	→ P537
		PSEP-C-20PI-①-2-0	Simple controller operable with the same signal as a solenoid valve			Refer to P555	—	→ P547
Solenoid valve multi-axis type PIO specification		MSEP-C-③④⑤⑥⑦⑧⑨⑩-①-2-0	Positioner type based on PIO control, allowing up to 8 axes to be connected	256 points		Refer to P572	—	→ P563
Solenoid valve multi-axis type Network specification		MSEP-C-③④⑤⑥⑦⑧⑨⑩-④-0-0	Field network-ready positioner type, allowing up to 8 axes to be connected			—	—	—
Positioner type High-output specification		PCON-CA-20PI-①-2-0	Equipped with a high-output driver Positioner type based on PIO control	512 points		Refer to P618	—	→ P607
Pulse-train type High-output specification		PCON-CA-20PI-PL□-2-0	Equipped with a high-output driver Pulse-train input type	(—)		—	—	
Field network type High-output specification		PCON-CA-20PI-④-0-0	Equipped with a high-output driver Supporting 7 major field networks	768 points		—	—	
Pulse Train Input Type (Differential Line Driver)		PCON-PL-20PI-①-2-0	Pulse train input type with differential line driver support	(—)		Refer to P628	—	→ P623
Pulse Train Input Type (Open Collector)		PCON-PO-20PI-①-2-0	Pulse train input type with open collector support					
Serial Communication Type		PCON-SE-20PI-N-0-0	Dedicated Serial Communication	64 points	—	—	—	
Program Control Type		PSEL-CS-1-20PI-①-2-0	Programmed operation is possible. Can operate up to 2 axes	1,500 points	Refer to P671	—	→ P665	

* This is for the single-axis PSEL. * ① indicates I/O type (NP/PN). * ② indicates power supply voltage (1: 100V / 2: 100~240V).
 * ③ indicates number of axes (1 to 8). * ④ indicates field network specification symbol. * □ indicates N (NPN specification) or P (PNP specification) symbol.

- Slider Type
- Mini
- Standard
- Controllers Integrated
- Rod Type
- Mini
- Standard
- Controllers Integrated
- Table/Arm/Flat Type
- Mini
- Standard
- Gripper/Rotary Type
- Linear Servo Type
- Clean-room Type
- Splash-Proof Type

- Pulse Motor
- Servo Motor (24V)
- Servo Motor (200V)
- Linear Servo Motor

RCACR-SA4C

Cleanroom ROBO Cylinder, Slider Type, Coupled, Actuator Width 40mm, 24V Servo Motor, Aluminum Base

Model Specification Items	RCACR — SA4C	— Encoder type	20	— Lead	— Stroke	— Applicable controller	— Cable length	— Options
	Series — Type		Motor type					
		I: Incremental A: Absolute	20: 20W Servo motor	10 : 10mm 5 : 5mm 2.5 : 2.5mm	50: 50mm ? 400: 400mm (50mm pitch increments)	A1: ACON ASEL A3: AMEC ASEP MSEP	N: None P: 1m S: 3m M: 5m X□□: Custom length R□□: Robot cable	See Options below.

* See page Pre-47 for details on the model descriptions.
* Absolute encoder models can only use ASEL. When the actuator is used with the simple absolute encoder, the model is considered an incremental model.



Power-saving



Technical References Appendix P.5

- POINT** Notes on selection
- (1) When the stroke increases, the maximum will drop to prevent the ball screw from reaching the critical rotational speed. Use the actuator specification table below to check the maximum speed at the stroke you desire.
 - (2) The load capacity is based on operation at an acceleration of 0.3G (0.2G for the 2.5mm-lead model). These values are the upper limits for the acceleration.
 - (3) See page A-71 for details on push motion.

*This product is equipped with a position adjusting screw at the A area shown above. (See dimensional drawing on the page to the right.)

Actuator Specifications

Lead and Payload

Model number	Motor output (W)	Lead (mm)	Max. Load Capacity		Rated thrust (N)	Stroke (mm)
			Horizontal (kg)	Vertical (kg)		
RCACR-SA4C-①-20-10-②-③-④-⑤	20	10	4	1	19.6	50~400 (every 50mm)
RCACR-SA4C-①-20-5-②-③-④-⑤		5	6	2.5	39.2	
RCACR-SA4C-①-20-2.5-②-③-④-⑤		2.5	8	4.5	78.4	

Stroke and Max. Speed/Suction Volume by Lead

Stroke Lead	50~400 (every 50mm)	Suction Volume (Nl/min)
10	665	50
5	330	30
2.5	165	15

(Unit: mm/s)

Code explanation ① Encoder ② Stroke ③ Applicable Controller ④ Cable length ⑤ Options *See page A-71 for details on push motion.

① Encoder type/② Stroke

② Stroke (mm)	Standard price	
	① Encoder Type	
	Incremental	Absolute
50	I	A
100	I	A
150	I	A
200	I	A
250	I	A
300	I	A
350	I	A
400	I	A

④ Cable Length

Type	Cable symbol	Standard price
Standard	P (1m)	—
	S (3m)	—
	M (5m)	—
Special length	X06 (6m) ~ X10 (10m)	—
	X11 (11m) ~ X15 (15m)	—
	X16 (16m) ~ X20 (20m)	—
	R01 (1m) ~ R03 (3m)	—
Robot Cable	R04 (4m) ~ R05 (5m)	—
	R06 (6m) ~ R10 (10m)	—
	R11 (11m) ~ R15 (15m)	—
	R16 (16m) ~ R20 (20m)	—

* See page A-59 for cables for maintenance.

⑤ Options

Name	Option code	See page	Standard price
Brake	B	→ A-42	—
Foot bracket	FT	→ A-48	—
Home sensor	HS	→ A-50	—
Power-saving	LA	→ A-52	—
Non-motor end specification	NM	→ A-52	—
Slider spacer	SS	→ A-55	—
Vacuum port on opposite side	VR	→ A-58	—

Actuator Specifications

Item	Description
Drive System	Ball screw, ø8mm, rolled C10
Positioning repeatability	±0.02mm
Lost Motion	0.1mm or less
Base	Material: Aluminum, white alumite treated
Allowable static moment	Ma: 6.9 N·m, Mb: 9.9 N·m, Mc: 17.0 N·m
Allowable dynamic moment (*)	Ma: 2.7 N·m, Mb: 3.9 N·m, Mc: 6.8 N·m
Allowable overhang	120mm or less in Ma, Mb and Mc directions
Grease Type	Low dust generation grease (both ball screw and guide)
Cleanliness	Class 10 (0.1µm)
Ambient operating temperature, humidity	0 to 40°C, 85% RH or less (Non-condensing)

(*) Based on 5,000km of traveling life

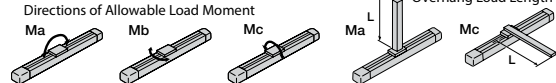

465 RCACR-SA4C

Dimensional Drawings

For Special Orders Appendix P.15

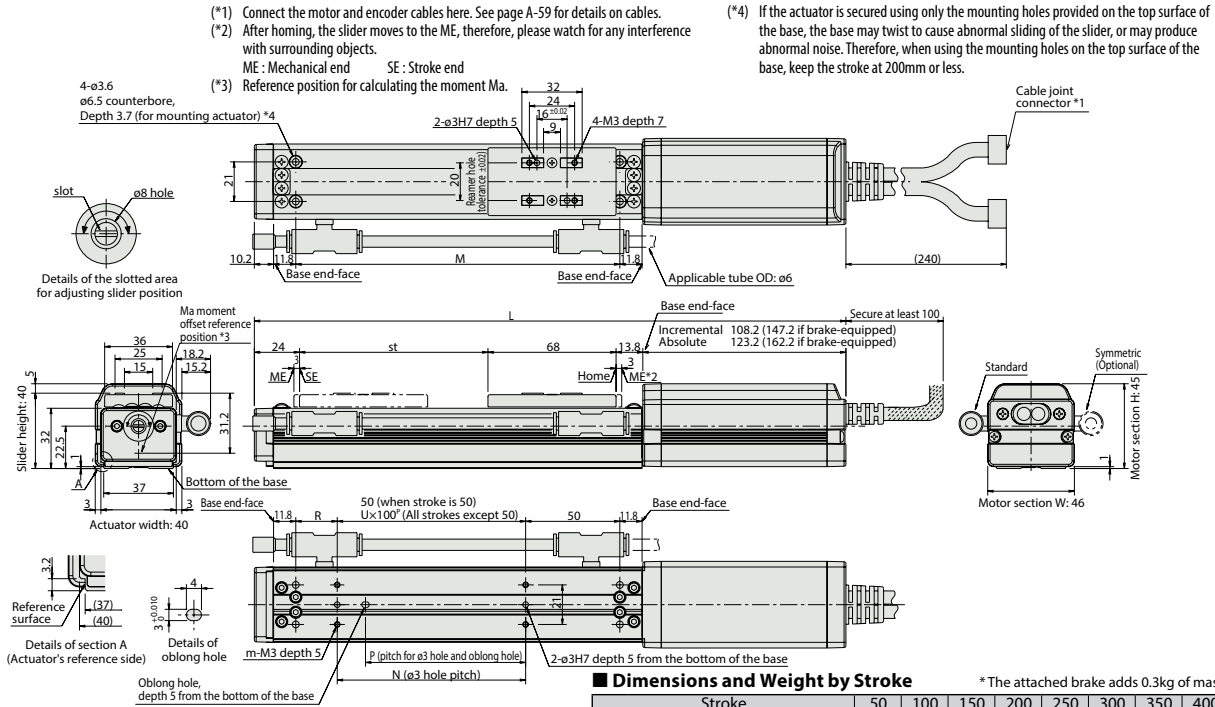

Dimensions and Weight by Stroke

* The attached brake adds 0.3kg of mass.

Stroke		50	100	150	200	250	300	350	400	
L	Incremental	Without brake	264	314	364	414	464	514	564	614
		With brake	303	353	403	453	503	553	603	653
	Absolute	Without brake	279	329	379	429	479	529	579	629
		With brake	318	368	418	468	518	568	618	668
M		122	172	222	272	322	372	422	472	
N		50	100	100	200	200	300	300	400	
P		35	85	85	185	185	285	285	385	
R		22	22	72	22	72	22	72	22	
U		-	1	1	2	2	3	3	4	
m		4	4	4	6	6	8	8	10	
Weight (kg)		0.7	0.8	0.9	1	1.1	1.2	1.3	1.4	

③ Applicable Controllers

RCACR series actuators can be operated with the controllers indicated below. Select the type according to your intended application.

Name	External view	Model number	Features	Maximum number of positioning points	Input power	Power-supply capacity	Standard price	Reference page	
Solenoid Valve Type		AMEC-C-20I①②③-2-1	Easy-to-use controller, even for beginners	3 points	AC100V	2.4A rated	—	→ P537	
		ASEP-C-20I①②③-2-0	Simple controller operable with the same signal as a solenoid valve					→ P547	
Solenoid valve multi-axis type PIO specification		MSEP-C-④⑤⑥⑦⑧-2-0	Positioner type based on PIO control, allowing up to 8 axes to be connected					→ P563	
Solenoid valve multi-axis type Network specification		MSEP-C-④⑤⑥⑦⑧-0-0	Field network-ready positioner type, allowing up to 8 axes to be connected	256 points	DC24V	(Standard) 1.3A rated 4.4A max. (Power-saving) 1.3A rated 2.5A max.	—	—	
Positioner type		ACON-C-20I①②③-2-0	Positioning is possible for up to 512 points	512 points					
Safety-Compliant Positioner Type		ACON-CG-20I①②③-2-0							
Pulse Train Input Type (Differential Line Driver)		ACON-PL-20I①②③-2-0	Pulse train input type with differential line driver support	(—)					→ P631
Pulse Train Input Type (Open Collector)		ACON-PO-20I①②③-2-0	Pulse train input type with open collector support						
Serial Communication Type		ACON-SE-20I①②③-N-0-0	Dedicated Serial Communication	64 points					—
Program Control Type		ASEL-CS-1-20I①②③-2-0	Programmed operation is possible. Can operate up to 2 axes	1,500 points					—

* This is for the single-axis ASEL.
* ④ indicates I/O type (NP/PN).

* ① indicates encoder type (I: incremental, A: absolute)
* ④ indicates number of axes (1 to 8).

* Enter the code "LA" in ① when the power-saving option is specified.
* ⑤ indicates field network specification symbol.

Slider Type

Mini

Standard

Controllers Integrated

Rod Type

Mini

Standard

Controllers Integrated

Table/ Arm/ Flat Type

Mini

Standard

Gripper/ Rotary Type

Linear Servo Type

Clean-room Type

Splash-Proof Type

Pulse Motor

Servo Motor (24V)

Servo Motor (200V)

Linear Servo Motor

RCACR-SA5C

Cleanroom ROBO Cylinder, Slider Type, Coupled, Actuator Width 52mm, 24V Servo Motor, Aluminum Base

Model Specification Items	RCACR	SA5C	□	20	□	□	□	□	□
	Series	Type	Encoder type	Motor type	Lead	Stroke	Applicable controller	Cable length	Options
	I: Incremental A: Absolute			20: 20W Servo motor	20: 20mm 12: 12mm 6: 6mm 3: 3mm	50: 50mm ? 500: 500mm (50mm pitch increments)	A1: ACON ASEL A3: AMEC ASEP MSEP	N: None P: 1m S: 3m M: 5m X□□: Custom length R□□: Robot cable	See Options below.

* See page Pre-47 for details on the model descriptions.
* Absolute encoder models can only use ASL. When the actuator is used with the simple absolute encoder, the model is considered an incremental model.



Power-saving



Technical References Appendix P.5



- (1) When the stroke increases, the maximum will drop to prevent the ball screw from reaching the critical rotational speed. Use the actuator specification table below to check the maximum speed at the stroke you desire.
- (2) The load capacity is based on operation at an acceleration of 0.3G (0.2G for the 3mm-lead model). These values are the upper limits for the acceleration.
- (3) See page A-71 for details on push motion.

* This product is equipped with a position adjusting screw at the A area shown above. (See dimensional drawing on the page to the right.)

Actuator Specifications

Lead and Payload

Model number	Motor output (W)	Lead (mm)	Max. Load Capacity		Rated thrust (N)	Stroke (mm)
			Horizontal (kg)	Vertical (kg)		
RCACR-SA5C-①-20-20-②-③-④-⑤	20	20	2	0.5	10.7	50~500 (every 50mm)
RCACR-SA5C-①-20-12-②-③-④-⑤		12	4	1	16.7	
RCACR-SA5C-①-20-6-②-③-④-⑤		6	8	2	33.3	
RCACR-SA5C-①-20-3-②-③-④-⑤		3	2	4	65.7	

Stroke and Max. Speed/Suction Volume by Lead (Unit: mm/s)

Stroke Lead	50~450 (every 50mm)	500 mm	Suction Volume (Nℓ/min)
	20	1300 <800>	
12	800	760	50
6	400	380	30
3	200	190	15

Code explanation ① Encoder ② Stroke ③ Applicable Controller ④ Cable length ⑤ Options * See page A-71 for details on push motion. * The values enclosed in < > apply to vertical settings.

① Encoder type/② Stroke

② Stroke (mm)	Standard price	
	① Encoder Type	
	Incremental	Absolute
50	—	—
100	—	—
150	—	—
200	—	—
250	—	—
300	—	—
350	—	—
400	—	—
450	—	—
500	—	—

④ Cable Length

Type	Cable symbol	Standard price
Standard	P (1m)	—
	S (3m)	—
	M (5m)	—
Special length	X06 (6m) ~ X10 (10m)	—
	X11 (11m) ~ X15 (15m)	—
	X16 (16m) ~ X20 (20m)	—
Robot Cable	R01 (1m) ~ R03 (3m)	—
	R04 (4m) ~ R05 (5m)	—
	R06 (6m) ~ R10 (10m)	—
	R11 (11m) ~ R15 (15m)	—
	R16 (16m) ~ R20 (20m)	—

* See page A-59 for cables for maintenance.

⑤ Options

Name	Option code	See page	Standard price
Brake	B	→ A-42	—
Foot bracket	FT	→ A-48	—
Home sensor	HS	→ A-50	—
Power-saving	LA	→ A-52	—
Non-motor end specification	NM	→ A-52	—
Vacuum port on opposite side	VR	→ A-58	—

Actuator Specifications

Item	Description
Drive System	Ball screw, ø10mm, rolled C10
Positioning repeatability (*1)	±0.02mm
Lost Motion	0.1mm or less
Base	Material: Aluminum, white alumite treated
Allowable static moment	Ma: 18.6 N·m, Mb: 26.6 N·m, Mc: 47.5 N·m
Allowable dynamic moment (*2)	Ma: 4.9 N·m, Mb: 6.8 N·m, Mc: 11.7 N·m
Allowable overhang	150mm or less in Ma, Mb and Mc directions
Grease Type	Low dust generation grease (both ball screw and guide)
Cleanliness	Class 10 (0.1µm)
Ambient operating temperature, humidity	0 to 40°C, 85% RH or less (Non-condensing)

(*1) The specification in [] applies when the lead is 20mm. (*2) Based on 5,000km of traveling life

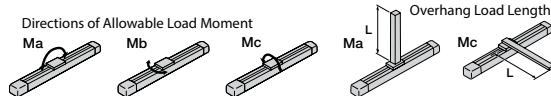

467 RCACR-SA5C

Dimensional Drawings

For Special Orders Appendix P.15

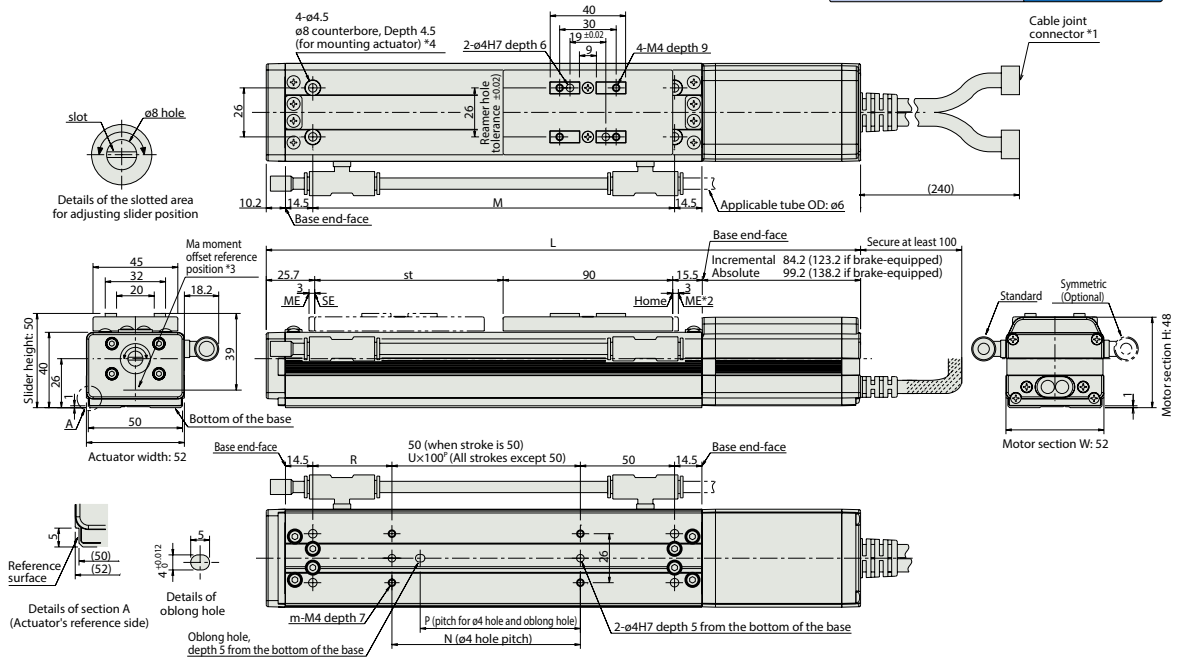

Dimensions and Weight by Stroke

* The attached brake adds 0.3kg of mass.

Stroke		50	100	150	200	250	300	350	400	450	500	
L	Incremental	Without brake	265.4	315.4	365.4	415.4	465.4	515.4	565.4	615.4	665.4	715.4
	With brake	304.4	354.4	404.4	454.4	504.4	554.4	604.4	654.4	704.4	754.4	
L	Abbsolute	Without brake	280.4	330.4	380.4	430.4	480.4	530.4	580.4	630.4	680.4	730.4
	With brake	319.4	369.4	419.4	469.4	519.4	569.4	619.4	669.4	719.4	769.4	
M			142	192	242	292	342	392	442	492	542	592
N			50	100	100	200	200	300	300	400	400	500
P			35	85	85	185	185	285	285	385	385	485
R			42	42	92	42	92	42	92	42	92	42
U			-	1	1	2	2	3	3	4	4	5
m			4	4	4	6	6	8	8	10	10	12
Weight (kg)			1.3	1.4	1.5	1.6	1.7	1.8	1.9	2	2.1	2.2

- (*1) Connect the motor and encoder cables here. See page A-59 for details on cables.
- (*2) After homing, the slider moves to the ME, therefore, please watch for any interference with surrounding objects.
ME: Mechanical end SE: Stroke end
- (*3) Reference position for calculating the moment Ma.
- (*4) If the actuator is secured using only the mounting holes provided on the top surface of the base, the base may twist to cause abnormal sliding of the slider, or may produce abnormal noise. Therefore, when using the mounting holes on the top surface of the base, keep the stroke at 300mm or less.

Applicable Controllers

RCACR series actuators can be operated with the controllers indicated below. Select the type according to your intended application.

Name	External view	Model number	Features	Maximum number of positioning points	Input power	Power-supply capacity	Standard price	Reference page
Solenoid Valve Type		AMEC-C-20I-2-1	Easy-to-use controller, even for beginners	3 points	AC100V	2.4A rated	—	→ P537
		ASEP-C-20I-2-0	Simple controller operable with the same signal as a solenoid valve					→ P547
Solenoid valve multi-axis type PIO specification		MSEP-C-20I-2-0	Positioner type based on PIO control, allowing up to 8 axes to be connected	256 points	DC24V	(Standard) 1.3A rated 4.4A max. (Power-saving) 1.3A rated 2.5A max.	—	→ P563
Solenoid valve multi-axis type Network specification		MSEP-C-20V-0-0	Field network-ready positioner type, allowing up to 8 axes to be connected					
Positioner type		ACON-C-20I-2-0	Positioning is possible for up to 512 points	512 points	DC24V	(Standard) 1.3A rated 4.4A max. (Power-saving) 1.3A rated 2.5A max.	—	—
Safety-Compliant Positioner Type		ACON-CG-20I-2-0						
Pulse Train Input Type (Differential Line Driver)		ACON-PL-20I-2-0	Pulse train input type with differential line driver support	—	DC24V	(Standard) 1.3A rated 4.4A max. (Power-saving) 1.3A rated 2.5A max.	—	→ P631
Pulse Train Input Type (Open Collector)		ACON-PO-20I-2-0						Pulse train input type with open collector support
Serial Communication Type		ACON-SE-20I-N-0-0	Dedicated Serial Communication	64 points	DC24V	(Standard) 1.3A rated 4.4A max. (Power-saving) 1.3A rated 2.5A max.	—	—
Program Control Type		ASEL-CS-1-20I-2-0	Programmed operation is possible. Can operate up to 2 axes	1,500 points	DC24V	(Standard) 1.3A rated 4.4A max. (Power-saving) 1.3A rated 2.5A max.	—	→ P675

* This is for the single-axis ASEL.
* indicates I/O type (NP/PN).

* indicates encoder type (I: incremental, A: absolute)
* indicates number of axes (1 to 8).

* Enter the code "LA" in when the power-saving option is specified.
* indicates field network specification symbol.

- Slider Type
- Mini
- Standard
- Controllers Integrated
- Rod Type
- Mini
- Standard
- Controllers Integrated
- Table/ Arm/ Flat Type
- Mini
- Standard
- Gripper/ Rotary Type
- Linear Servo Type
- Clean-room Type
- Splash-Proof Type
- Pulse Motor
- Servo Motor (24V)
- Servo Motor (200V)
- Linear Servo Motor

RCACR-SA6C

Cleanroom ROBO Cylinder, Slider Type, Coupled, Actuator Width 58mm, 24V Servo Motor, Aluminum Base

Model Specification Items	RCACR	SA6C	30						
	Series	Type	Encoder type	Motor type	Lead	Stroke	Applicable controller	Cable length	Options
	I: Incremental A: Absolute		30: 30W Servo motor	20: 20mm 12: 12mm 6: 6mm 3: 3mm	50: 50mm ?	600: 600mm (50mm pitch increments)	A1: ACON ASEL A3: AMEC ASEP MSEP	N: None P: 1m S: 3m M: 5m X□□: Custom length R□□: Robot cable	See Options below.

* See page Pre-47 for details on the model descriptions.
* Absolute encoder models can only use ASL. When the actuator is used with the simple absolute encoder, the model is considered an incremental model.



Power-saving



Technical References Appendix P.5

POINT Notes on selection

- (1) When the stroke increases, the maximum will drop to prevent the ball screw from reaching the critical rotational speed. Use the actuator specification table below to check the maximum speed at the stroke you desire.
- (2) The load capacity is based on operation at an acceleration of 0.3G (0.2G for the 3mm-lead model). These values are the upper limits for the acceleration.
- (3) See page A-71 for details on push motion.

*This product is equipped with a position adjusting screw at the A area shown above. (See dimensional drawing on the page to the right.)

Actuator Specifications

Lead and Payload

Model number	Motor output (W)	Lead (mm)	Max. Load Capacity		Rated thrust (N)	Stroke (mm)
			Horizontal (kg)	Vertical (kg)		
RCACR-SA6C-①-30-20-②-③-④-⑤	30	20	3	0.5	15.8	50~600 (every 50mm)
RCACR-SA6C-①-30-12-②-③-④-⑤		12	6	1.5	24.2	
RCACR-SA6C-①-30-6-②-③-④-⑤		6	12	3	48.4	
RCACR-SA6C-①-30-3-②-③-④-⑤		3	18	6	96.8	

Stroke and Max. Speed/Suction Volume by Lead

Stroke / Lead	Stroke and Max. Speed/Suction Volume by Lead (Unit: mm/s)				
	50~450 (every 50mm)	500 mm	550 mm	600 mm	Suction Volume (Nℓ/min)
20	1300 <800>	1160	990	800	80
12	800	760	640	540	50
6	400	380	320	270	30
3	200	190	160	135	15

Code explanation ① Encoder ② Stroke ③ Applicable Controller ④ Cable length ⑤ Options *See page A-71 for details on push motion. *The values enclosed in < > apply to vertical settings.

① Encoder type/② Stroke

② Stroke (mm)	Standard price	
	① Encoder Type	
	Incremental	Absolute
50	I	A
100	I	A
150	I	A
200	I	A
250	I	A
300	I	A
350	I	A
400	I	A
450	I	A
500	I	A
550	I	A
600	I	A

④ Cable Length

Type	Cable symbol	Standard price
Standard	P (1m)	—
	S (3m)	—
	M (5m)	—
Special length	X06 (6m) ~ X10 (10m)	—
	X11 (11m) ~ X15 (15m)	—
	X16 (16m) ~ X20 (20m)	—
	R01 (1m) ~ R03 (3m)	—
Robot Cable	R04 (4m) ~ R05 (5m)	—
	R06 (6m) ~ R10 (10m)	—
	R11 (11m) ~ R15 (15m)	—
	R16 (16m) ~ R20 (20m)	—

* See page A-59 for cables for maintenance.

⑤ Options

Name	Option code	See page	Standard price
Brake	B	→ A-42	—
Foot bracket	FT	→ A-48	—
Home sensor	HS	→ A-50	—
Power-saving	LA	→ A-52	—
Non-motor end specification	NM	→ A-52	—
Vacuum port on opposite side	VR	→ A-58	—

Actuator Specifications

Item	Description
Drive System	Ball screw, ø10mm, rolled C10
Positioning repeatability (*1)	±0.02mm [±0.03mm]
Lost Motion	0.1mm or less
Base	Material: Aluminum, white alumite treated
Allowable static moment	Ma: 38.3 N·m, Mb: 54.7 N·m, Mc: 81.0 N·m
Allowable dynamic moment (*2)	Ma: 8.9 N·m, Mb: 12.7 N·m, Mc: 18.6 N·m
Allowable overhang	220mm or less in Ma, Mb and Mc directions
Grease Type	Low dust generation grease (both ball screw and guide)
Cleanliness	Class 10 (0.1µm)
Ambient operating temperature, humidity	0 to 40°C, 85% RH or less (Non-condensing)

(*1) The specification in [] applies when the lead is 20mm. (*2) Based on 5,000km of traveling life

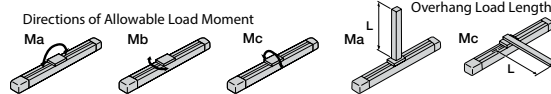

469 RCACR-SA6C

Dimensional Drawings

For Special Orders

Appendix P.15

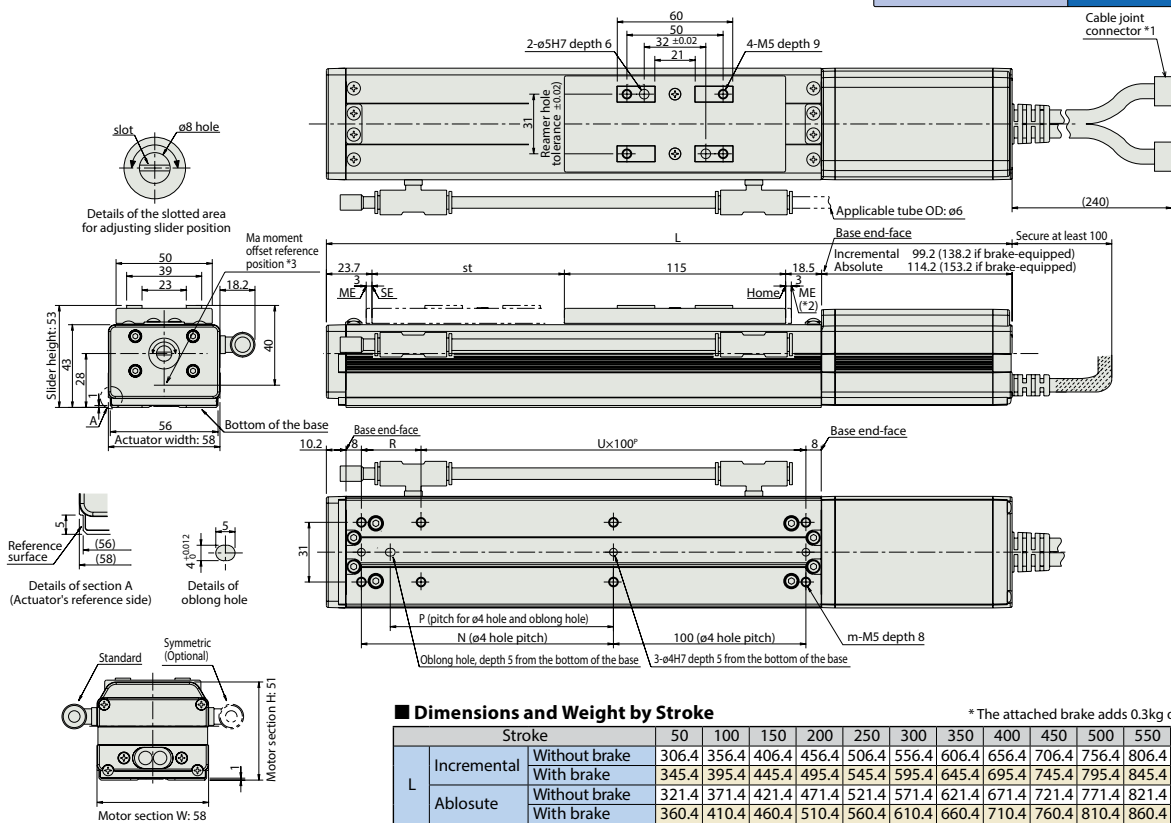

- (*1) Connect the motor and encoder cables here. See page A-59 for details on cables.
- (*2) After homing, the slider moves to the ME, therefore, please watch for any interference with surrounding objects. ME: Mechanical end SE: Stroke end
- (*3) Reference position for calculating the moment Ma.

■ Dimensions and Weight by Stroke

* The attached brake adds 0.3kg of mass.

Stroke		50	100	150	200	250	300	350	400	450	500	550	600	
L	Incremental	Without brake	306.4	356.4	406.4	456.4	506.4	556.4	606.4	656.4	706.4	756.4	806.4	856.4
	With brake		345.4	395.4	445.4	495.4	545.4	595.4	645.4	695.4	745.4	795.4	845.4	895.4
L	Absolute	Without brake	321.4	371.4	421.4	471.4	521.4	571.4	621.4	671.4	721.4	771.4	821.4	871.4
	With brake		360.4	410.4	460.4	510.4	560.4	610.4	660.4	710.4	760.4	810.4	860.4	910.4
	N		81	131	181	231	281	331	381	431	481	531	581	631
	P		66	116	166	216	266	316	366	416	466	516	566	616
	R		81	31	81	31	81	31	81	31	81	31	81	31
	U		1	2	2	3	3	4	4	5	5	6	6	7
	m		6	8	8	10	10	12	12	14	14	16	1	18
	Weight (kg)		1.4	1.6	1.8	2	2.2	2.4	2.6	2.8	3	3.2	3.4	3.6

③ Applicable Controllers

RCACR series actuators can be operated with the controllers indicated below. Select the type according to your intended application.

Name	External view	Model number	Features	Maximum number of positioning points	Input power	Power-supply capacity	Standard price	Reference page
Solenoid Valve Type		AMEC-C-30I(①-③)-2-1	Easy-to-use controller, even for beginners	3 points	AC100V	2.4A rated	—	→ P537
		ASEP-C-30I(①-③)-2-0	Simple controller operable with the same signal as a solenoid valve					→ P547
Solenoid valve multi-axis type PIO specification		MSEP-C-④-⑤-⑥-⑦-⑧-2-0	Positioner type based on PIO control, allowing up to 8 axes to be connected	256 points	DC24V	(Standard) 1.3A rated 4.4A max.	—	→ P563
Solenoid valve multi-axis type Network specification		MSEP-C-④-⑤-⑥-⑦-⑧-0-0	Field network-ready positioner type, allowing up to 8 axes to be connected					
Positioner type		ACON-C-30I(①-③)-2-0	Positioning is possible for up to 512 points	512 points	DC24V	(Power-saving) 1.3A rated 2.2A max.	—	—
Safety-Compliant Positioner Type		ACON-CG-30I(①-③)-2-0						
Pulse Train Input Type (Differential Line Driver)		ACON-PL-30I(①-③)-2-0	Pulse train input type with differential line driver support	—	DC24V	(Power-saving) 1.3A rated 2.2A max.	—	→ P631
Pulse Train Input Type (Open Collector)		ACON-PO-30I(①-③)-2-0						Pulse train input type with open collector support
Serial Communication Type		ACON-SE-30I(①-③)-N-0-0	Dedicated Serial Communication	64 points	DC24V	(Power-saving) 1.3A rated 2.2A max.	—	—
Program Control Type		ASEL-CS-1-30I(①-③)-④-2-0	Programmed operation is possible. Can operate up to 2 axes	1,500 points	DC24V	(Power-saving) 1.3A rated 2.2A max.	—	→ P675

* This is for the single-axis ASEL. * ① indicates encoder type (I: incremental, A: absolute) * Enter the code "LA" in ① when the power-saving option is specified.
 * ④ indicates I/O type (NP/PN). * ⑤ indicates number of axes (1 to 8). * ⑥ indicates field network specification symbol.



RCACR-SA6C 470

Slider Type

Mini

Standard

Controllers Integrated

Rod Type

Mini

Standard

Controllers Integrated

Table/Arm/Flat Type

Mini

Standard

Gripper/Rotary Type

Linear Servo Type

Clean-room Type

Splash-Proof Type

Pulse Motor

Servo Motor (24V)

Servo Motor (200V)

Linear Servo Motor

RCACR-SA5D

Cleanroom ROBO Cylinder, Slider, Built-in Type, Actuator Width 52mm, 24V Servo Motor, Aluminum Base

Model Specification Items	RCACR — SA5D	—	Encoder type	—	20	—	Lead	—	Stroke	—	Applicable controller	—	Cable length	—	Options
	Series — Type		I: Incremental A: Absolute		20: 20W Servo motor		12: 12mm 6: 6mm 3: 3mm		50: 50mm ?		A1: ACON ASEL A3: AMEC ASEP MSEP		N: None P: 1m S: 3m M: 5m X□□: Custom length R□□: Robot cable		See Options below.

* See page Pre-47 for details on the model descriptions.
* Absolute encoder models can only use ASL. When the actuator is used with the simple absolute encoder, the model is considered an incremental model.



Power-saving



Technical References Appendix P.5

- POINT**
Notes on selection
- (1) When the stroke increases, the maximum will drop to prevent the ball screw from reaching the critical rotational speed. Use the actuator specification table below to check the maximum speed at the stroke you desire.
 - (2) The load capacity is based on operation at an acceleration of 0.3G (0.2G for the 3mm-lead model). These values are the upper limits for the acceleration.
 - (3) The cleanliness class 10 is for horizontal usage. Please note that the actuator may not support C10 when used on its side or in vertical orientation.
 - (4) See page A-71 for details on push motion.

Actuator Specifications						Stroke and Max. Speed/Suction Volume by Lead			
Lead and Payload						Stroke and Max. Speed/Suction Volume by Lead			
Model number	Motor output (W)	Lead (mm)	Max. Load Capacity	Rated thrust (N)	Stroke (mm)	Stroke Lead	50~450 (every 50mm)	500 mm	Suction Volume (Nℓ/min)
RCACR-SA5D-①-20-12-②-③-④-⑤	20	12	Horizontal (kg) 4 Vertical (kg) 1	16.7	50~500 (every 50mm)	12	800	760	50
RCACR-SA5D-①-20-6-②-③-④-⑤		6	8 2	33.3		6	400	380	30
RCACR-SA5D-①-20-3-②-③-④-⑤		3	12 4	65.7		3	200	190	15

Code explanation ① Encoder ② Stroke ③ Applicable Controller ④ Cable length ⑤ Options *See page A-71 for details on push motion. (Unit: mm/s)

② Stroke (mm)	Standard price	
	① Encoder Type	
	Incremental	Absolute
50	—	—
100	—	—
150	—	—
200	—	—
250	—	—
300	—	—
350	—	—
400	—	—
450	—	—
500	—	—

Type	Cable symbol		Standard price
	④ Cable Length		
Standard	P (1m)	—	—
	S (3m)	—	—
	M (5m)	—	—
Special length	X06 (6m) ~ X10 (10m)	—	—
	X11 (11m) ~ X15 (15m)	—	—
	X16 (16m) ~ X20 (20m)	—	—
	R01 (1m) ~ R03 (3m)	—	—
Robot Cable	R04 (4m) ~ R05 (5m)	—	—
	R06 (6m) ~ R10 (10m)	—	—
	R11 (11m) ~ R15 (15m)	—	—
	R16 (16m) ~ R20 (20m)	—	—

* See page A-59 for cables for maintenance.

⑤ Options			
Name	Option code	See page	Standard price
Brake (cable exiting from end)	BE	→ A-42	—
Brake (cable exiting from left)	BL	→ A-42	—
Brake (cable exiting from right)	BR	→ A-42	—
Foot bracket	FT	→ A-48	—
Power-saving	LA	→ A-52	—
Non-motor end specification	NM	→ A-52	—
Vacuum port on opposite side	VR	→ A-58	—

Actuator Specifications	
Item	Description
Drive System	Ball screw, ø10mm, rolled C10
Positioning repeatability	±0.02mm
Lost Motion	0.1mm or less
Base	Material: Aluminum, white alumite treated
Allowable static moment	Ma: 18.6 N·m, Mb: 26.6 N·m, Mc: 47.5 N·m
Allowable dynamic moment (*)	Ma: 4.9 N·m, Mb: 6.8 N·m, Mc: 11.7 N·m
Allowable overhang	150mm or less in Ma, Mb and Mc directions
Grease Type	Low dust generation grease (both ball screw and guide)
Cleanliness	Class 10 (0.1µm)
Ambient operating temperature, humidity	0 to 40°C, 85% RH or less (Non-condensing)

(*) Based on 5,000km of traveling life

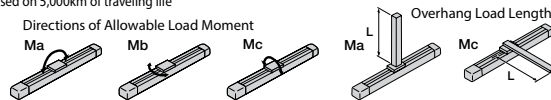

471 RCACR-SA5D

Dimensional Drawings

For Special Orders Appendix P.15

* Note that in order to change the home orientation, arrangements must be made to send in the product to IAI.
 * In the non-motor end model (NM), the new home position is set 3mm inward from the ME opposite of the motor side.

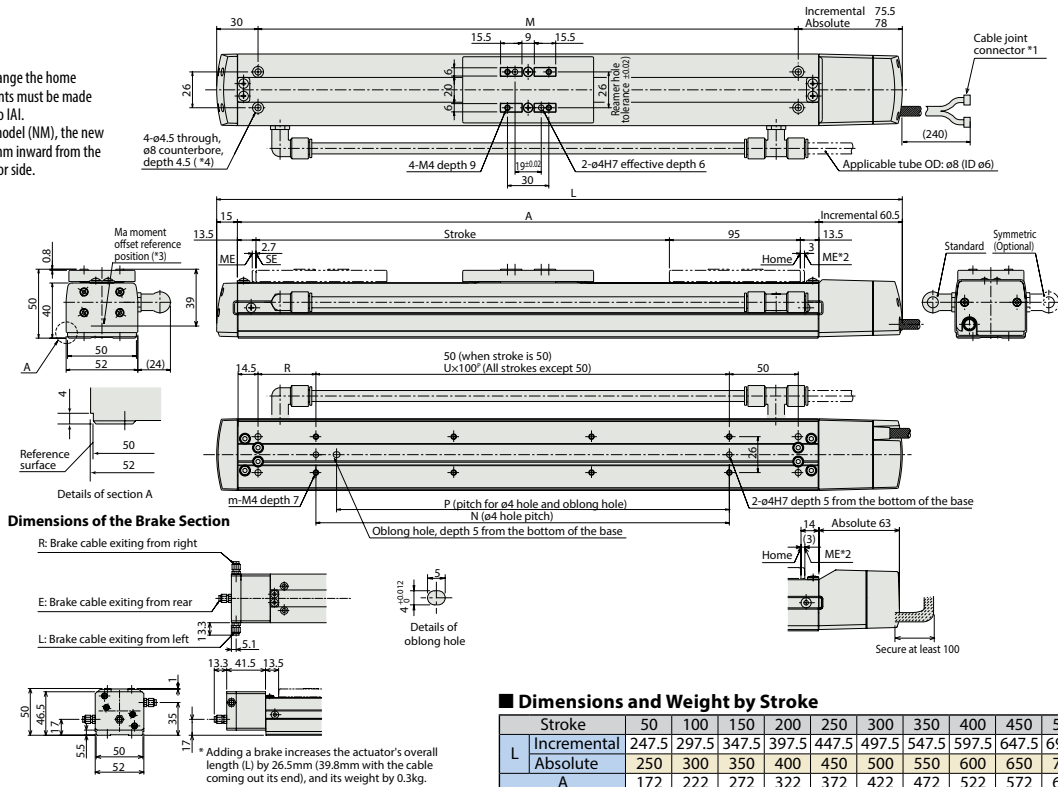

Dimensions of the Brake Section

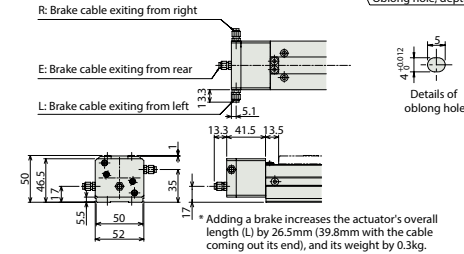

■ Dimensions and Weight by Stroke

L	Stroke		Stroke									
	Incremental	Absolute	50	100	150	200	250	300	350	400	450	500
A	172	222	272	322	372	422	472	522	572	622	672	722
M	142	192	242	292	342	392	442	492	542	592	642	692
N	50	100	100	200	200	300	300	400	400	500	500	500
P	35	85	85	185	185	285	285	385	385	485	485	485
R	42	42	92	42	92	42	92	42	92	42	92	42
U	-	1	1	2	2	3	3	4	4	5	5	5
m	4	4	4	6	6	8	8	10	10	12	12	12
Weight (kg)	1.2	1.3	1.4	1.5	1.6	1.7	1.8	1.9	2.0	2.1	2.1	2.1

- (*1) Connect the motor and encoder cables here. See page A-59 for details on cables.
- (*2) After homing, the slider moves to the ME, therefore, please watch for any interference with surrounding objects.
ME: Mechanical end SE: Stroke end
- (*3) Reference position for calculating the moment Ma.
- (*4) If the actuator is secured using only the mounting holes provided on the top surface of the base, the base may twist to cause abnormal sliding of the slider, or may produce abnormal noise. Therefore, when using the mounting holes on the top surface of the base, keep the stroke at 300mm or less.

③ Applicable Controllers

RCACR series actuators can be operated with the controllers indicated below. Select the type according to your intended application.

Name	External view	Model number	Features	Maximum number of positioning points	Input power	Power-supply capacity	Standard price	Reference page
Solenoid Valve Type		AMEC-C-20I-①-②-2-1	Easy-to-use controller, even for beginners	3 points	AC100V	2.4A rated	—	→ P537
		ASEP-C-20I-①-②-2-0	Simple controller operable with the same signal as a solenoid valve					→ P547
Solenoid valve multi-axis type PIO specification		MSEP-C-④-②-2-0	Positioner type based on PIO control, allowing up to 8 axes to be connected	256 points	DC24V	(Standard) 1.3A rated 4.4A max. (Power-saving) 1.3A rated 2.5A max.	—	→ P563
Solenoid valve multi-axis type Network specification		MSEP-C-④-③-0-0	Field network-ready positioner type, allowing up to 8 axes to be connected					→ P631
Positioner type		ACON-C-20I-①-②-2-0	Positioning is possible for up to 512 points	512 points	—	—	—	—
Safety-Compliant Positioner Type		ACON-CG-20I-①-②-2-0	Positioning is possible for up to 512 points	—				
Pulse Train Input Type (Differential Line Driver)		ACON-PL-20I-①-②-2-0	Pulse train input type with differential line driver support	—	—	—	—	→ P631
Pulse Train Input Type (Open Collector)		ACON-PO-20I-①-②-2-0	Pulse train input type with open collector support					—
Serial Communication Type		ACON-SE-20I-①-N-0-0	Dedicated Serial Communication	64 points	—	—	—	—
Program Control Type		ASEL-CS-1-20-①-②-2-0	Programmed operation is possible. Can operate up to 2 axes	1,500 points	—	—	—	→ P675

* This is for the single-axis ASEL. * ① indicates encoder type (I: incremental, A: absolute) * Enter the code "LA" in ① when the power-saving option is specified.
 * ② indicates I/O type (NP/PN). * ④ indicates number of axes (1 to 8). * ③ indicates field network specification symbol.

IAI

RCACR-SA5D 472

- Slider Type
- Mini
- Standard
- Controllers Integrated
- Rod Type
- Mini
- Standard
- Controllers Integrated
- Table/Arm/Flat Type
- Mini
- Standard
- Gripper/Rotary Type
- Linear Servo Type
- Clean-room Type
- Splash-Proof Type
- Pulse Motor
- Servo Motor (24V)
- Servo Motor (200V)
- Linear Servo Motor

RCACR-SA6D

Cleanroom ROBO Cylinder, Slider, Built-in Type, Actuator Width 58mm, 24V Servo Motor, Aluminum Base

Model Specification Items	RCACR	SA6D	30						
	Series	Type	Encoder type	Motor type	Lead	Stroke	Applicable controller	Cable length	Options
			I: Incremental A: Absolute	30: 30W Servo motor	12: 12mm 6: 6mm 3: 3mm	50: 50mm ? 600: 600mm (50mm pitch increments)	A1: ACON ASEL A3: AMEC ASEP MSEP	N: None P: 1m S: 3m M: 5m X□□: Custom length R□□: Robot cable	See Options below.

* See page Pre-47 for details on the model descriptions.
* Absolute encoder models can only use ASEL. When the actuator is used with the simple absolute encoder, the model is considered an incremental model.



Power-saving



Technical References Appendix P.5

- POINT** Notes on selection
- When the stroke increases, the maximum will drop to prevent the ball screw from reaching the critical rotational speed. Use the actuator specification table below to check the maximum speed at the stroke you desire.
 - The load capacity is based on operation at an acceleration of 0.3G (0.2G for the 3mm-lead model). These values are the upper limits for the acceleration.
 - The cleanliness class 10 is for horizontal usage. Please note that the actuator may not support C10 when used on its side or in vertical orientation.
 - See page A-71 for details on push motion.

Actuator Specifications

Lead and Payload

Model number	Motor output (W)	Lead (mm)	Max. Load Capacity		Rated thrust (N)	Stroke (mm)
			Horizontal (kg)	Vertical (kg)		
RCACR-SA6D-①-30-12-②-③-④-⑤	30	12	6	1.5	24.2	50~600 (every 50mm)
RCACR-SA6D-①-30-6-②-③-④-⑤		6	12	3	48.4	
RCACR-SA6D-①-30-3-②-③-④-⑤		3	18	6	96.8	

Stroke and Max. Speed/Suction Volume by Lead

Stroke Lead	50~450 (every 50mm)	500 mm	550 mm	600 mm	Suction Volume (N ₂ /min)
	12	800	760	640	540
6	400	380	320	270	30
3	200	190	160	135	15

Code explanation ① Encoder ② Stroke ③ Applicable Controller ④ Cable length ⑤ Options *See page A-71 for details on push motion. (Unit: mm/s)

① Encoder type/② Stroke

② Stroke (mm)	Standard price	
	① Encoder Type	
	Incremental	Absolute
50	I	A
100	I	A
150	I	A
200	I	A
250	I	A
300	I	A
350	I	A
400	I	A
450	I	A
500	I	A
550	I	A
600	I	A

⑤ Options

Name	Option code	See page	Standard price
Brake (cable exiting from end)	BE	→ A-42	—
Brake (cable exiting from left)	BL	→ A-42	—
Brake (cable exiting from right)	BR	→ A-42	—
Foot bracket	FT	→ A-48	—
Power-saving	LA	→ A-52	—
Non-motor end specification	NM	→ A-52	—
Vacuum port on opposite side	VR	→ A-58	—

④ Cable Length

Type	Cable symbol	Standard price
Standard	P (1m)	—
	S (3m)	—
	M (5m)	—
Special length	X06 (6m) ~ X10 (10m)	—
	X11 (11m) ~ X15 (15m)	—
	X16 (16m) ~ X20 (20m)	—
	R01 (1m) ~ R03 (3m)	—
Robot Cable	R04 (4m) ~ R05 (5m)	—
	R06 (6m) ~ R10 (10m)	—
	R11 (11m) ~ R15 (15m)	—
	R16 (16m) ~ R20 (20m)	—

* See page A-59 for cables for maintenance.

Actuator Specifications

Item	Description
Drive System	Ball screw, ø10mm, rolled C10
Positioning repeatability	±0.02mm
Lost Motion	0.1mm or less
Base	Material: Aluminum, white alumite treated
Allowable static moment	Ma: 38.3 N·m, Mb: 54.7 N·m, Mc: 81.0 N·m
Allowable dynamic moment (*)	Ma: 8.9 N·m, Mb: 12.7 N·m, Mc: 18.6 N·m
Allowable overhang	220mm or less in Ma, Mb and Mc directions
Grease Type	Low dust generation grease (both ball screw and guide)
Cleanliness	Class 10 (0.1µm)
Ambient operating temperature, humidity	0 to 40°C, 85% RH or less (Non-condensing)

(*) Based on 5,000km of traveling life

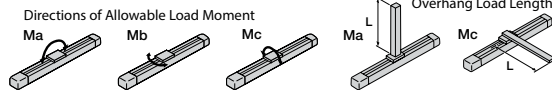

473 RCACR-SA6D

Dimensional Drawings

For Special Orders Appendix P.15

* Note that in order to change the home orientation, arrangements must be made to send in the product to IAI.
 * In the non-motor end model (NM), the new home position is set 3mm inward from the ME opposite of the motor side.

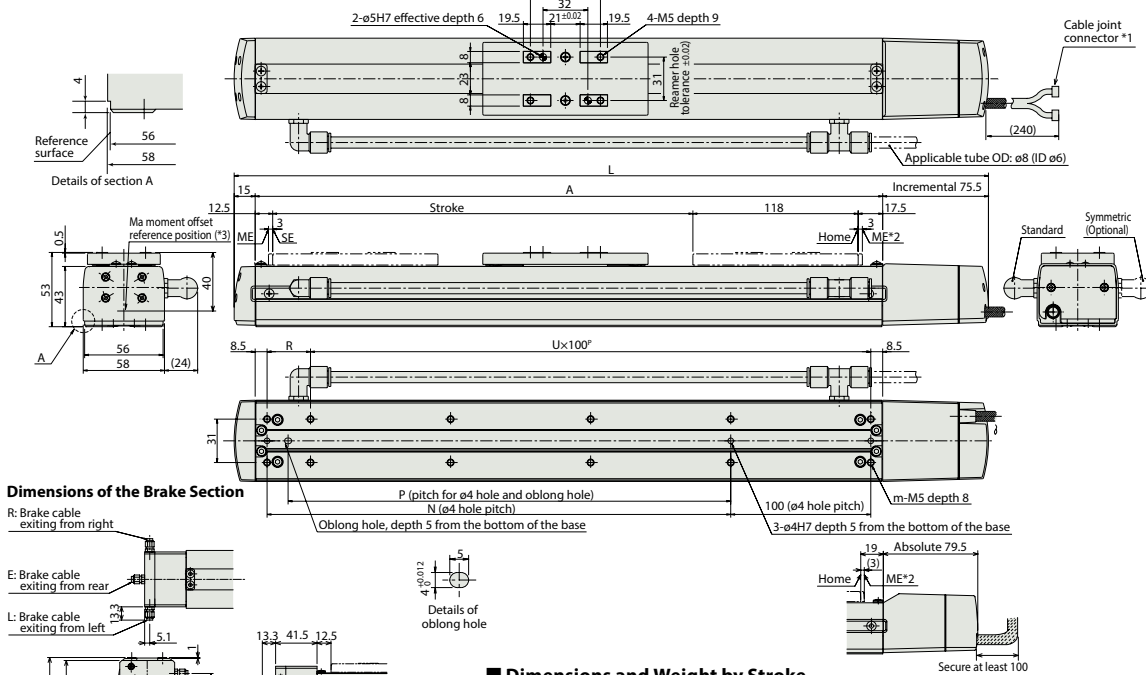

Dimensions of the Brake Section

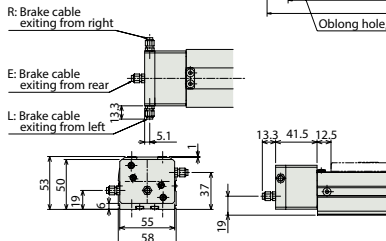

* Adding a brake increases the actuator's overall length (L) by 26.5mm (39.8mm with the cable coming out its end), and its weight by 0.3kg.

- (*1) Connect the motor and encoder cables here. See page A-59 for details on cables.
- (*2) After homing, the slider moves to the ME, therefore, please watch for any interference with surrounding objects.
- ME : Mechanical end SE : Stroke end
- (*3) Reference position for calculating the moment Ma.

■ Dimensions and Weight by Stroke

Stroke	50	100	150	200	250	300	350	400	450	500	550	600	
L	Incremental	288.5	338.5	388.5	438.5	488.5	538.5	588.5	638.5	688.5	738.5	788.5	838.5
	Absolute	292.5	342.5	392.5	442.5	492.5	542.5	592.5	642.5	692.5	742.5	792.5	842.5
A	198	248	298	348	398	448	498	548	598	648	698	748	
N	81	131	181	231	281	331	381	431	481	531	581	631	
P	66	116	166	216	266	316	366	416	466	516	566	616	
R	81	31	81	31	81	31	81	31	81	31	81	31	
U	1	2	2	3	3	4	4	5	5	6	6	7	
m	6	8	8	10	10	12	12	14	14	16	16	18	
Weight (kg)	1.3	1.5	1.7	1.9	2.1	2.3	2.5	2.7	2.9	3.1	3.3	3.5	

③ Applicable Controllers

RCACR series actuators can be operated with the controllers indicated below. Select the type according to your intended application.

Name	External view	Model number	Features	Maximum number of positioning points	Input power	Power-supply capacity	Standard price	Reference page
Solenoid Valve Type		AMEC-C-30I①②③-2-1	Easy-to-use controller, even for beginners	3 points	AC100V	2.4A rated	—	→ P537
		ASEP-C-30I①②③-2-0	Simple controller operable with the same signal as a solenoid valve					→ P547
Solenoid valve multi-axis type PIO specification		MSEP-C-④⑤⑥⑦⑧-2-0	Positioner type based on PIO control, allowing up to 8 axes to be connected	256 points	DC24V	(Standard) 1.3A rated 4.4A max. (Power-saving) 1.3A rated 2.2A max.	—	→ P563
Solenoid valve multi-axis type Network specification		MSEP-C-④⑤⑥⑦⑧-0-0	Field network-ready positioner type, allowing up to 8 axes to be connected					→ P631
Positioner type		ACON-C-30I①②③-2-0	Positioning is possible for up to 512 points	512 points	—	—	—	—
Safety-Compliant Positioner Type		ACON-CG-30I①②③-2-0	Positioning is possible for up to 512 points	—				
Pulse Train Input Type (Differential Line Driver)		ACON-PL-30I①②③-2-0	Pulse train input type with differential line driver support	—	—	—	—	→ P631
Pulse Train Input Type (Open Collector)		ACON-PO-30I①②③-2-0	Pulse train input type with open collector support					—
Serial Communication Type		ACON-SE-30I①②③-N-0-0	Dedicated Serial Communication	64 points	—	—	—	—
Program Control Type		ASEL-CS-1-30I①②③-2-0	Programmed operation is possible. Can operate up to 2 axes	1,500 points	—	—	—	→ P675

* This is for the single-axis ASEL.
 * ④ indicates I/O type (NP/PN).

* ① indicates encoder type (I: incremental, A: absolute)
 * ④ indicates number of axes (1 to 8).

* Enter the code "LA" in ① when the power-saving option is specified.
 * ⑤ indicates field network specification symbol.

IAI

RCACR-SA6D 474

- Slider Type
- Mini
- Standard
- Controllers Integrated
- Rod Type
- Mini
- Standard
- Controllers Integrated
- Table/Arm/Flat Type
- Mini
- Standard
- Gripper/Rotary Type
- Linear Servo Type
- Clean-room Type
- Splash-Proof Type
- Pulse Motor
- Servo Motor (24V)
- Servo Motor (200V)
- Linear Servo Motor

RCS3CR-SA8C

Cleanroom Robo Cylinder, Slider Type, Actuator Width 80mm, 200V Servo Motor, Aluminum Base, Coupled

RCS3PCR-SA8C

Cleanroom Robo Cylinder, Slider Type, Actuator Width 80mm, 200V Servo Motor, Aluminum Base, Coupled **High-precision specification**

Model Specification Items

Series	Type	Encoder type	Motor type	Lead	Stroke	Applicable controller	Cable length	Options
RCS3CR : Standard specification RCS3PCR : High-precision specification	SA8C	I: Incremental A: Absolute	100: Servo motor, 100W 150: Servo motor, 150W	30: 30mm 20: 20mm 10: 10mm 5: 5mm	50: 50mm 1100: 1100mm (50mm pitch increments)	T1: XSEL-J/K T2: SCON MSCON SSEL XSEL-P/Q XSEL-R/S	N: None P: 1m S: 3m M: 5m X□□: Custom length R□□: Robot cable	See Options below. * Be sure to specify a code indicating your desired cable exit direction.

* See page Pre-47 for details on the model descriptions.



*CE compliance is optional.

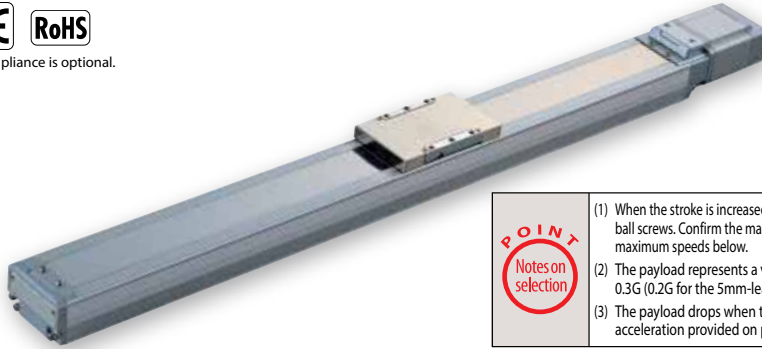

Technical References Appendix P.5

- Notes on selection**
- (1) When the stroke is increased, the maximum speed will drop to prevent reaching dangerous speeds of ball screws. Confirm the maximum speed at the desired stroke by referring to the table of strokes and maximum speeds below.
 - (2) The payload represents a value when the actuator is operated at a horizontal acceleration of 0.3G (0.2G for the 5mm-lead model) and vertical acceleration of 0.2G.
 - (3) The payload drops when the acceleration is raised. For details, refer to the list of payloads by acceleration provided on page A-108.

Actuator Specifications

Lead and Payload

Model number	Motor output (W)	Lead (mm)	Maximum payload Horizontal (kg)	Maximum payload Vertical (kg)	Rated thrust (N)	Stroke (mm)	
RCS3CR[RCS3PCR]-SA8C-①-100-30-②-③-④-⑤	100	30	8	2	56.6	50 ~ 1100 (every 50mm)	
RCS3CR[RCS3PCR]-SA8C-①-100-20-②-③-④-⑤		20	20	4	84.9		
RCS3CR[RCS3PCR]-SA8C-①-100-10-②-③-④-⑤		10	40	8	169.8		
RCS3CR[RCS3PCR]-SA8C-①-100-5-②-③-④-⑤		5	80	16	339.7		
RCS3CR[RCS3PCR]-SA8C-①-150-30-②-③-④-⑤		150	30	12	3		85.1
RCS3CR[RCS3PCR]-SA8C-①-150-20-②-③-④-⑤			20	30	6		127.6
RCS3CR[RCS3PCR]-SA8C-①-150-10-②-③-④-⑤	10		60	12	255.3		

Code explanation ① Encoder type ② Stroke ③ Applicable Controller ④ Cable length ⑤ Options

Stroke and Max. Speed/Suction Volume by Lead (Unit: mm/s)

Stroke Lead	50 to 650 (every 50mm)	700	750	800	850	900	950	1000	1050	1100	Suction Rate (N ₂ /min)
30	1800	1510	1340	1190	1070	960	870	790	720	660	130 (160) (*)
20	1200	1010	890	790	710	640	580	530	480	440	110
10	600	500	440	390	350	320	290	260	240	220	60
5	300	260	220	190	170	160	140	130	120	110	30

(*) 130N₂/min if the speed is 1,500mm/s or below, or 160N₂/min if the speed exceeds 1,500mm/s.

① Encoder Type / ② Stroke

② Stroke (mm)	Standard Prices							
	RCS3CR-SA8C				RCS3PCR-SA8C			
	① Encoder Type							
	Incremental Motor wattage		Absolute Motor wattage		Incremental Motor wattage		Absolute Motor wattage	
	100W	150W	100W	150W	100W	150W	100W	150W
50/100	—	—	—	—	—	—	—	—
150/200	—	—	—	—	—	—	—	—
250/300	—	—	—	—	—	—	—	—
350/400	—	—	—	—	—	—	—	—
450/500	—	—	—	—	—	—	—	—
550/600	—	—	—	—	—	—	—	—
650/700	—	—	—	—	—	—	—	—
750/800	—	—	—	—	—	—	—	—
850/900	—	—	—	—	—	—	—	—
950/1000	—	—	—	—	—	—	—	—
1050/1100	—	—	—	—	—	—	—	—

④ Cable Length

Type	Cable symbol	Standard price
Standard type	P (1m)	—
	S (3m)	—
	M (5m)	—
Special length	X06 (6m) ~ X10 (10m)	—
	X11 (11m) ~ X15 (15m)	—
	X16 (16m) ~ X20 (20m)	—
Robot cable	R01 (1m) ~ R03 (3m)	—
	R04 (4m) ~ R05 (5m)	—
	R06 (6m) ~ R10 (10m)	—
	R11 (11m) ~ R15 (15m)	—
	R16 (16m) ~ R20 (20m)	—
	R20 (20m)	—

* See page A-59 for cables for maintenance.

⑤ Options

Name	Option code	Page	Standard Price
Cables exit from back left	A1E	→ A-41	—
Cables exit from left side	A1S	→ A-41	—
Cables exit from back right	A3E	→ A-41	—
Cables exit from right side	A3S	→ A-41	—
Brake	B	→ A-42	—
CE compliance	CE	→ A-42	—
Non-motor end specification	NM	→ A-52	—
L-shaped suction joint	VL	→ A-58	—
No suction joint specification	VN	→ A-58	—

Actuator Specifications RCS3PCR specifications are shown in []. (Other items are the same.)

Item	Description
Drive method	Ball screw, ø16mm, rolled C10 (rolled C5)
Positioning repeatability	±0.02mm [±0.01mm]
Lost motion	0.1mm [0.05mm] or less
Base	Material: Aluminum, white alumite treatment
Allowable static moment	Ma: 113.5 N·m, Mb: 177 N·m, Mc: 266 N·m
Allowable dynamic moment (*)	Ma: 23.1 N·m, Mb: 32.9 N·m, Mc: 54.1 N·m
Allowable overhang	390mm or less in Ma, Mb and Mc directions
Grease	Low dust-raising grease is used (for both the ball screw and guide)
Cleanliness class	Class 10 (0.1µm)
Ambient operating temperature/humidity	0 to 40°C, 85% RH max. (Non-condensing)

(*) When the traveling life is assumed as 10,000km. Direction of allowable load moment.

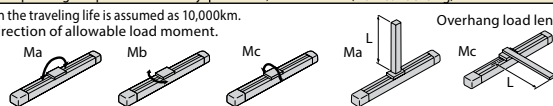

475 RCS3CR/RCS3PCR-SA8C

Dimensional Drawings

For Special Orders Appendix P.15

- (*1) Connect the motor and encoder cables here. See page A-59 for details on cables.
- (*2) After homing, the slider moves to the ME, therefore, please watch for any interference with surrounding objects.
ME : Mechanical end
SE : Stroke end
- (*3) Reference position for calculating the Ma moment

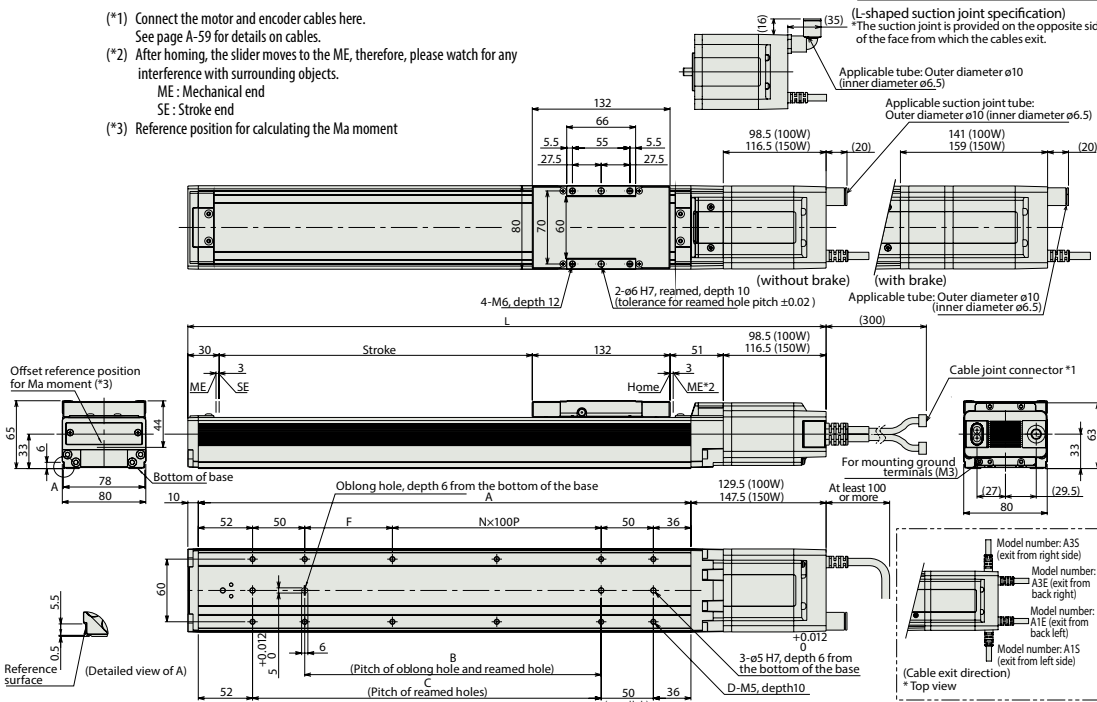

③ Dimensions and Weights by Stroke

Stroke	L																							
	50	100	150	200	250	300	350	400	450	500	550	600	650	700	750	800	850	900	950	1000	1050	1100		
100W	without brake	361.5	411.5	461.5	511.5	561.5	611.5	661.5	711.5	761.5	811.5	861.5	911.5	961.5	1011.5	1061.5	1111.5	1161.5	1211.5	1261.5	1311.5	1361.5	1411.5	
	with brake	404	454	504	554	604	654	704	754	804	854	904	954	1004	1054	1104	1154	1204	1254	1304	1354	1404	1454	
150W	without brake	379.5	429.5	479.5	529.5	579.5	629.5	679.5	729.5	779.5	829.5	879.5	929.5	979.5	1029.5	1079.5	1129.5	1179.5	1229.5	1279.5	1329.5	1379.5	1429.5	
	with brake	422	472	522	572	622	672	722	772	822	872	922	972	1022	1072	1122	1172	1222	1272	1322	1372	1422	1472	
A	222	272	322	372	422	472	522	572	622	672	722	772	822	872	922	972	1022	1072	1122	1172	1222	1272	1322	
B	34	84	134	184	234	284	334	384	434	484	534	584	634	684	734	784	834	884	934	984	1034	1084	1134	
C	84	134	184	234	284	334	384	434	484	534	584	634	684	734	784	834	884	934	984	1034	1084	1134		
D	8	8	10	10	12	12	14	14	16	16	18	18	20	20	22	22	24	24	26	26	28	28	30	
F	34	84	34	84	34	84	34	84	34	84	34	84	34	84	34	84	34	84	34	84	34	84	34	
N	0	0	1	1	2	2	3	3	4	4	5	5	6	6	7	7	8	8	9	9	10	10		
Weight (kg)	100W	without brake	2.8	3.1	3.4	3.7	4.0	4.3	4.6	4.9	5.2	5.5	5.8	6.1	6.4	6.7	7.0	7.3	7.6	7.9	8.2	8.5	8.8	9.1
	with brake	3.2	3.5	3.8	4.1	4.4	4.7	5.0	5.3	5.6	5.9	6.2	6.5	6.8	7.1	7.4	7.7	8.0	8.3	8.6	8.9	9.2	9.5	
150W	without brake	2.9	3.2	3.5	3.8	4.1	4.4	4.7	5.0	5.3	5.6	5.9	6.2	6.5	6.8	7.1	7.4	7.7	8.0	8.3	8.6	8.9	9.2	
	with brake	3.4	3.7	4.0	4.3	4.6	4.9	5.2	5.5	5.8	6.1	6.4	6.7	7.0	7.3	7.6	7.9	8.2	8.5	8.8	9.1	9.4	9.7	

③ Applicable Controllers

RCS3CR-series actuators can be operated with the following controllers. Select an appropriate controller type according to your application.

Name	External view	Model number	Features	Maximum number of positioning points	Input power	Power supply capacity	Standard price	Reference page	
Positioner mode		SCON-CA-100①-NP-2-②③ SCON-CA-150①-NP-2-②③	Up to 512 positioning points are supported.	512 points	Single-phase 100VAC Single-phase 200VAC 3-phase 200VAC (XSEL-P/Q/R/S ONLY)	388 VA max. * 1-axis specification operated at 150W	—	→ P643	
Solenoid valve mode			Actuators can be operated through the same control used for solenoid valves.	7 points					
Field network type			Movement by numerical specification is supported.	768 points					
Pulse-train input control type			Dedicated pulse-train input type	(—)					
Positioner multi-axis, network type		MSCON-C-1-100①-④-0-①② MSCON-C-1-150①-④-0-①②	Up to 6 axes can be operated. Movement by numerical specification is supported.	256 points	3-phase 200VAC (XSEL-P/Q/R/S ONLY)	—	→ P655		
Program control type, 1 to 2 axes		SSEL-CS-1-100①-NP-2-②③ SSEL-CS-1-150①-NP-2-②③	Program operation is supported. Up to 2 axes can be operated.	20,000 points				—	→ P685
Program control type, 1 to 8 axes		XSEL-④-1-100①-N1-EEE-2-④⑤ XSEL-④-1-150①-N1-EEE-2-④⑤	Program operation is supported. Up to 8 axes can be operated.	Varies depending on the number of axes connected					

* This is for the single-axis MSCON, SSEL, and XSEL.

* ① indicates the power-supply voltage type (1: 100V / 2: Single-phase 200V).

* ② indicates the power-supply voltage type (1: 100V / 2: Single-phase 200V / 3: Three-phase 200V).

* ④ indicates the encoder type (I: Incremental / A: Absolute).

* ⑤ indicates the XSEL type (J / K / P / Q / R / S).

* ④ indicates field network specification symbol.

RCS3CR-SS8C

Cleanroom Robo Cylinder, Slider Type, Actuator Width 80mm, 200V Servo Motor, Steel Base, Coupled

RCS3PCR-SS8C

Cleanroom Robo Cylinder, Slider Type, Actuator Width 80mm, 200V Servo Motor, Steel Base, Coupled **High-precision specification**

Model Specification Items	Series	Type	Encoder type	Motor type	Lead	Stroke	Applicable controller	Cable length	Options
RCS3CR : Standard specification RCS3PCR : High-precision specification	SS8C		I: Incremental A: Absolute	100: Servo motor, 100W 150: Servo motor, 150W	30: 30mm 20: 20mm 10: 10mm 5: 5mm	50: 50mm 1000: 1000mm (50mm pitch increments)	T1: XSEL-J/K T2: SCON MSCON SSEL XSEL-P/Q XSEL-R/S	N: None P: 1m S: 3m M: 5m X□□: Custom length R□□: Robot cable	See Options below. * Be sure to specify a code indicating your desired cable exit direction.

* See page Pre-47 for details on the model descriptions.



*CE compliance is optional.



Technical References Appendix P.5

- POINT** Notes on selection
- When the stroke is increased, the maximum speed will drop to prevent reaching dangerous speeds of ball screws. Confirm the maximum speed at the desired stroke by referring to the table of strokes and maximum speeds below.
 - The payload represents a value when the actuator is operated at a horizontal acceleration of 0.3G (0.2G for the 5mm-lead model) and vertical acceleration of 0.2G.
 - The payload drops when the acceleration is raised. For details, refer to the list of payloads by acceleration provided on page A-108.

Actuator Specifications

Lead and Payload

Model number	Motor output (W)	Lead (mm)	Maximum payload Horizontal (kg) / Vertical (kg)	Rated thrust (N)	Stroke (mm)
RCS3CR[RCS3PCR]-SS8C-①-100-30-②-③-④-⑤	100	30	8 / 2	56.6	50 ~ 1000 (every 50mm)
RCS3CR[RCS3PCR]-SS8C-①-100-20-②-③-④-⑤		20	20 / 4	84.9	
RCS3CR[RCS3PCR]-SS8C-①-100-10-②-③-④-⑤		10	40 / 8	169.8	
RCS3CR[RCS3PCR]-SS8C-①-100-5-②-③-④-⑤		5	80 / 16	339.7	
RCS3CR[RCS3PCR]-SS8C-①-150-30-②-③-④-⑤	150	30	12 / 3	85.1	
RCS3CR[RCS3PCR]-SS8C-①-150-20-②-③-④-⑤		20	30 / 6	127.6	
RCS3CR[RCS3PCR]-SS8C-①-150-10-②-③-④-⑤		10	60 / 12	255.3	

Code explanation ① Encoder type ② Stroke ③ Applicable Controller ④ Cable length ⑤ Options

Stroke and Max. Speed/Suction Volume by Lead (Unit: mm/s)

Stroke Lead	50 to 600 (every 50mm)	650	700	750	800	850	900	950	1000	Suction Rate N _L /min
30	1800	1660	1460	1295	1155	1035	935	850	775	160 (190) (*)
20	1200	1105	970	860	770	690	625	565	515	120
10	600	550	485	430	385	345	310	280	255	80
5	300	275	240	215	190	170	150	140	125	30

(*) 160N_L/min if the speed is 1,500mm/s or below, or 190N_L/min if the speed exceeds 1,500mm/s.

Encoder Type / Stroke

Stroke (mm)	Standard Prices					
	RCS3CR-SS8C			RCS3PCR-SS8C		
	Incremental		Absolute	Incremental		Absolute
	Motor wattage	Motor wattage	Motor wattage	Motor wattage	Motor wattage	
	100W	150W	100W	150W	100W	150W
50/100	—	—	—	—	—	—
150/200	—	—	—	—	—	—
250/300	—	—	—	—	—	—
350/400	—	—	—	—	—	—
450/500	—	—	—	—	—	—
550/600	—	—	—	—	—	—
650/700	—	—	—	—	—	—
750/800	—	—	—	—	—	—
850/900	—	—	—	—	—	—
950/1000	—	—	—	—	—	—

Cable Length

Type	Cable symbol	Standard price
Standard type	P (1m)	—
	S (3m)	—
	M (5m)	—
Special length	X06 (6m) ~ X10 (10m)	—
	X11 (11m) ~ X15 (15m)	—
	X16 (16m) ~ X20 (20m)	—
Robot cable	R01 (1m) ~ R03 (3m)	—
	R04 (4m) ~ R05 (5m)	—
	R06 (6m) ~ R10 (10m)	—
	R11 (11m) ~ R15 (15m)	—
	R16 (16m) ~ R20 (20m)	—

* See page A-59 for cables for maintenance.

Options

Name	Option code	Page	Standard Price
Cables exit from back left	A1E	→ A-41	—
Cables exit from left side	A1S	→ A-41	—
Cables exit from back right	A3E	→ A-41	—
Cables exit from right side	A3S	→ A-41	—
Brake	B	→ A-42	—
CE compliance	CE	→ A-42	—
Non-motor end specification	NM	→ A-52	—
L-shaped suction joint specification	VL	→ A-58	—

Actuator Specifications RCS3PCR specifications are shown in []. (Other items are the same.)

Item	Description
Drive method	Ball screw, ø16mm, rolled C10 (rolled C5)
Positioning repeatability	±0.02mm [±0.01mm]
Lost motion	0.1mm [0.05mm] or less
Base	Material: Dedicated alloy steel
Allowable static moment	Ma: 198.9 N·m, Mb: 198.9 N·m, Mc: 416.7 N·m
Allowable dynamic moment (*)	Ma: 36.3 N·m, Mb: 36.3 N·m, Mc: 77.4 N·m
Allowable overhang	450mm or less in Ma, Mb and Mc directions
Grease	Low dust-raising grease is used (for both the ball screw and guide)
Cleanliness class	Class 10 (0.1µm)
Ambient operating temperature/humidity	0 to 40°C, 85% RH max. (Non-condensing)

(*) When the traveling life is assumed as 10,000km. Direction of allowable load moment.

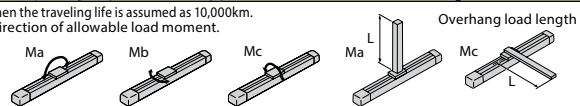

477

RCS3CR/RCS3PCR-SS8C

Dimensional Drawings

For Special Orders Appendix P.15

- (*1) Connect the motor and encoder cables here. See page A-59 for details on cables.
- (*2) After homing, the slider moves to the ME, therefore, please watch for any interference with surrounding objects.
ME : Mechanical end
SE : Stroke end
- (*3) Reference position for calculating the Ma moment

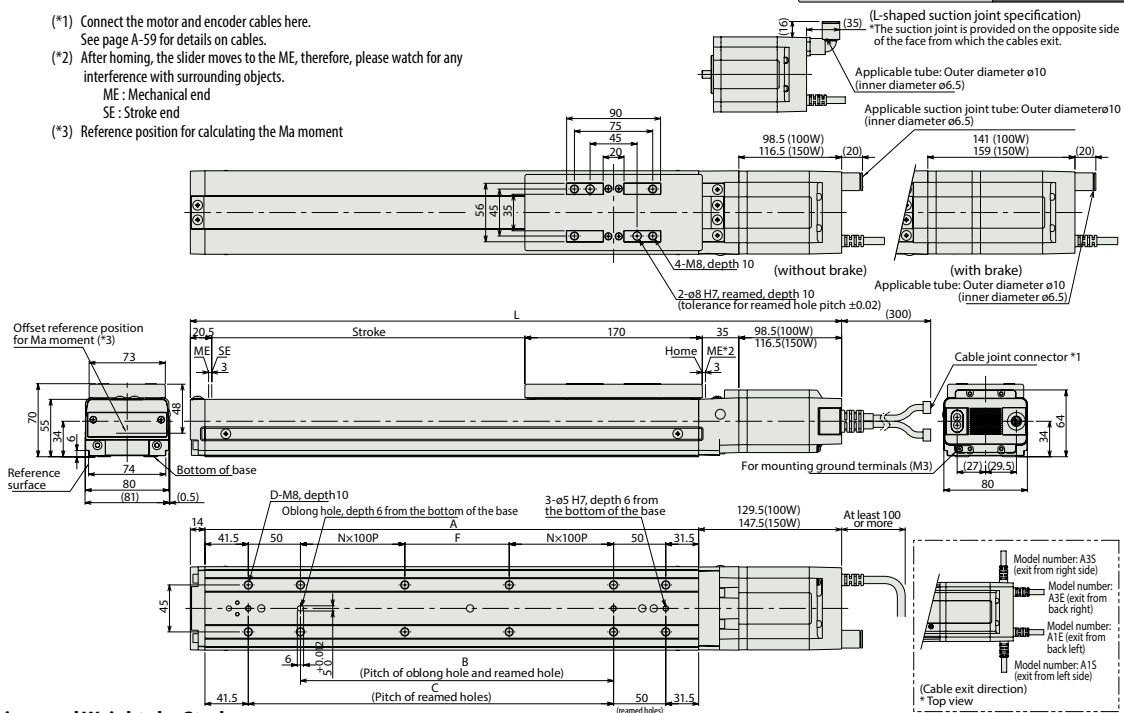

■ Dimensions and Weights by Stroke

L	Stroke	Stroke																				
		50	100	150	200	250	300	350	400	450	500	550	600	650	700	750	800	850	900	950	1000	
100W	without brake	374	424	474	524	574	624	674	724	774	824	874	924	974	1024	1074	1124	1174	1224	1274	1324	
	with brake	416.5	466.5	516.5	566.5	616.5	666.5	716.5	766.5	816.5	866.5	916.5	966.5	1016.5	1066.5	1116.5	1166.5	1216.5	1266.5	1316.5	1366.5	
150W	without brake	392	442	492	542	592	642	692	742	792	842	892	942	992	1042	1092	1142	1192	1242	1292	1342	
	with brake	434.5	484.5	534.5	584.5	634.5	684.5	734.5	784.5	834.5	884.5	934.5	984.5	1034.5	1084.5	1134.5	1184.5	1234.5	1284.5	1334.5	1384.5	
A		223	273	323	373	423	473	523	573	623	673	723	773	823	873	923	973	1023	1073	1123	1173	
B		50	100	150	200	250	300	350	400	450	500	550	600	650	700	750	800	850	900	950	1000	
C		100	150	200	250	300	350	400	450	500	550	600	650	700	750	800	850	900	950	1000	1050	
D		8	8	8	10	12	12	12	14	16	16	16	18	20	20	22	24	24	24	24	26	
F		50	100	150	0	50	100	150	0	50	100	150	0	50	100	150	0	50	100	150	0	
N		0	0	0	1	1	1	1	2	2	2	3	3	3	3	4	4	4	4	4	5	
Weight (kg)	100W	without brake	5.3	5.8	6.4	6.9	7.5	8.0	8.6	9.1	9.7	10.2	10.8	11.3	11.9	12.4	13.0	13.5	14.1	14.6	15.2	15.7
	with brake	5.7	6.2	6.8	7.3	7.9	8.4	9.0	9.5	10.1	10.6	11.2	11.7	12.3	12.8	13.4	13.9	14.5	15.0	15.6	16.1	
150W	without brake	5.3	5.9	6.4	7.0	7.5	8.1	8.6	9.2	9.7	10.3	10.8	11.4	11.9	12.5	13.0	13.6	14.1	14.7	15.2	15.8	
	with brake	5.8	6.3	6.9	7.4	8.0	8.5	9.1	9.6	10.2	10.7	11.3	11.8	12.4	12.9	13.5	14.0	14.6	15.1	15.7	16.2	

③ Applicable Controllers

RCS3CR-series actuators can be operated with the following controllers. Select an appropriate controller type according to your application.

Name	External view	Model number	Features	Maximum number of positioning points	Input power	Power supply capacity	Standard price	Reference page
Positioner mode		SCON-CA-100①-NP-2-②③ SCON-CA-150①-NP-2-②③	Up to 512 positioning points are supported.	512 points	Single-phase 100VAC Single-phase 200VAC 3-phase 200VAC (XSEL-P/Q/R/S ONLY)	388 VA max. * 1-axis specification operated at 150W	—	→ P643
Solenoid valve mode			Actuators can be operated through the same control used for solenoid valves.	7 points				
Field network type			Movement by numerical specification is supported.	768 points				
Pulse-train input control type			Dedicated pulse-train input type	(—)				
Positioner multi-axis, network type		MSCON-C-1-100①-V-0-②③ MSCON-C-1-150①-V-0-②③	Up to 6 axes can be operated. Movement by numerical specification is supported.	256 points			→ P655	
Program control type, 1 to 2 axes		SSEL-CS-1-100①-NP-2-②③ SSEL-CS-1-150①-NP-2-②③	Program operation is supported. Up to 2 axes can be operated.	20,000 points				→ P685
Program control type, 1 to 8 axes		XSEL-④-1-100①-N1-EEE-2-⑤⑥ XSEL-④-1-150①-N1-EEE-2-⑤⑥	Program operation is supported. Up to 8 axes can be operated.	Varies depending on the number of axes connected				

* This is for the single-axis MSCON, SSEL, and XSEL.

* ① indicates the power-supply voltage type (1: 100V / 2: Single-phase 200V).

* ②③ indicates the power-supply voltage type (1: 100V / 2: Single-phase 200V / 3: Three-phase 200V).

* ④ indicates the encoder type (I: Incremental / A: Absolute).

* ⑤⑥ indicates the XSEL type (J / K / P / Q / R / S).

* ⑦ indicates field network specification symbol.

RCS2CR-SA4C

Cleanroom Robo Cylinder, Slider Type, Coupled, Actuator Width 40mm, 200V Servo Motor, Aluminum Base

Model Specification Items	RCS2CR — SA4C	—	20	—	—	—	—	—	—	—
	Series — Type	Encoder type	Motor type	Lead	Stroke	Applicable controller	Cable length	Options	See options below.	
		I: Incremental A: Absolute	20: 20W Servo motor	10: 10mm 5: 5mm 2.5: 2.5mm	50: 50mm ? 400: 400mm (50mm pitch increments)	T1: XSEL-J/K T2: SCON MSCON SSEL XSEL-P/Q XSEL-R/S	N: None P: 1m S: 3m M: 5m X□□: Custom length R□□: Robot cable			

* See page Pre-47 for details on the model descriptions.



*CE compliance is optional.



Technical References Appendix P.5



- When the stroke increases, the maximum will drop to prevent the ball screw from reaching the critical rotational speed. Use the actuator specification table below to check the maximum speed at the stroke you desire.
- The load capacity is based on operation at an acceleration of 0.3G (0.2G for the 2.5mm-lead model). These values are the upper limits for the acceleration.
- See page A-71 for details on push motion.

*This product is equipped with a position adjusting screw at the A area shown above. (See dimensional drawing on the page to the right.)

Actuator Specifications							Stroke and Max. Speed/Suction Volume by Lead			
Lead and Payload							Stroke (mm)	Stroke Lead	50~400 (every 50mm)	Suction Volume (Nℓ/min)
Model number	Motor output (W)	Lead (mm)	Max. Load Capacity		Rated thrust (N)					
RCS2CR-SA4C-①-20-10-②-③-④-⑤	20	10	4	1	19.6	50~400 (every 50mm)	10	665	50	
RCS2CR-SA4C-①-20-5-②-③-④-⑤		5	6	2.5	39.2		5	330	30	
RCS2CR-SA4C-①-20-2.5-②-③-④-⑤		2.5	8	4.5	78.4		2.5	165	15	

Code explanation ① Encoder ② Stroke ③ Applicable Controller ④ Cable length ⑤ Options *See page A-71 for details on push motion. (Unit: mm/s)

② Stroke (mm)	Standard price	
	① Encoder Type	
	Incremental	Absolute
50	—	—
100	—	—
150	—	—
200	—	—
250	—	—
300	—	—
350	—	—
400	—	—

Type	Standard price	
	Cable symbol	Standard price
Standard	P (1m)	—
	S (3m)	—
	M (5m)	—
Special length	X06 (6m) ~ X10 (10m)	—
	X11 (11m) ~ X15 (15m)	—
	X16 (16m) ~ X20 (20m)	—
Robot Cable	R01 (1m) ~ R03 (3m)	—
	R04 (4m) ~ R05 (5m)	—
	R06 (6m) ~ R10 (10m)	—
	R11 (11m) ~ R15 (15m)	—
	R16 (16m) ~ R20 (20m)	—

* See page A-59 for cables for maintenance.

⑤ Options				
Name	Option code	See page	Standard price	
Brake	B	→ A-42	—	
CE compliance	CE	→ A-42	—	
Foot bracket	FT	→ A-48	—	
Home sensor	HS	→ A-50	—	
Non-motor end specification	NM	→ A-52	—	
Slider spacer	SS	→ A-55	—	
Vacuum port on opposite side	VR	→ A-58	—	

Actuator Specifications	
Item	Description
Drive System	Ball screw, ø8mm, rolled C10
Positioning repeatability	±0.02mm
Lost Motion	0.1mm or less
Base	Material: Aluminum, white alumite treated
Allowable static moment	Ma: 6.9 N·m, Mb: 9.9 N·m, Mc: 17.0 N·m
Allowable dynamic moment (*)	Ma: 2.7 N·m, Mb: 3.9 N·m, Mc: 6.8 N·m
Allowable overhang	120mm or less in Ma, Mb and Mc directions
Grease Type	Low dust generation grease (both ball screw and guide)
Cleanliness	Class 10 (0.1µm)
Ambient operating temperature, humidity	0 to 40°C, 85% RH or less (Non-condensing)

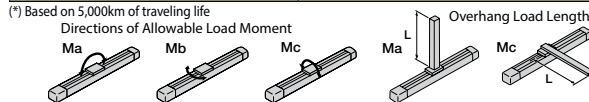

479 RCS2CR-SA4C

Dimensional Drawings

For Special Orders

Appendix P.15

(*1) Connect the motor and encoder cables here. See page A-59 for details on cables.

(*2) After homing, the slider moves to the ME, therefore, please watch for any interference with surrounding objects.

ME : Mechanical end SE : Stroke end
 (*3) Reference position for calculating the moment Ma.

(*4) If the actuator is secured using only the mounting holes provided on the top surface of the base, the base may twist to cause abnormal sliding of the slider, or may produce abnormal noise. Therefore, when using the mounting holes on the top surface of the base, keep the stroke at 200mm or less.

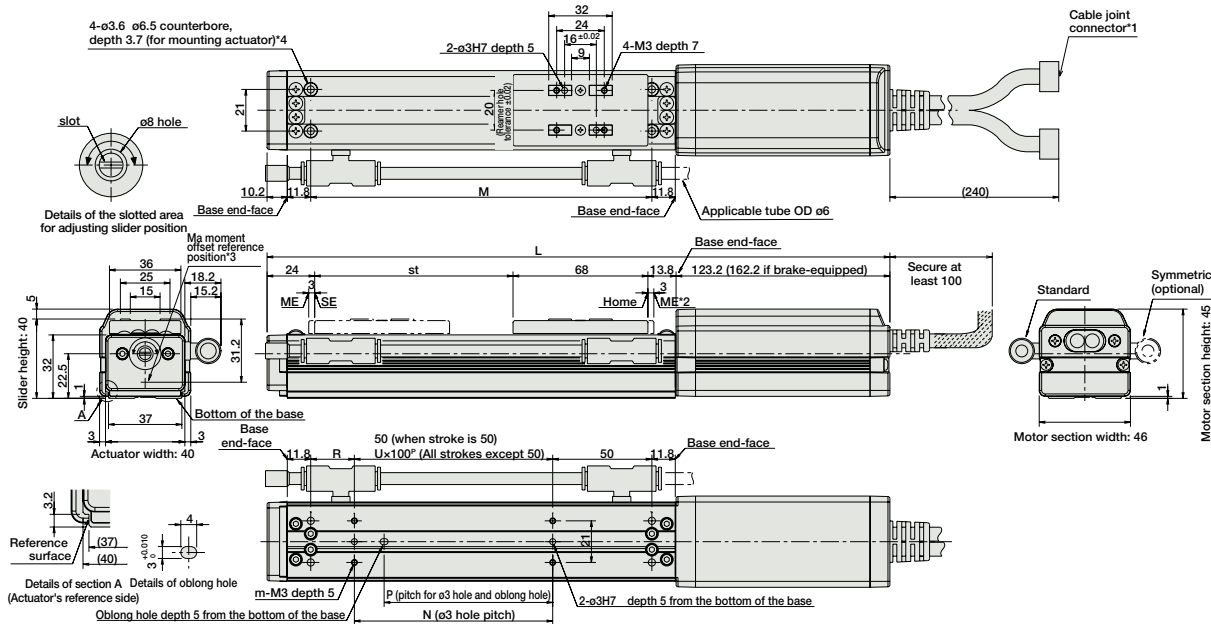

Dimensions and Weight by Stroke

* Brake-equipped models are heavier by 0.3kg.

Stroke	50	100	150	200	250	300	350	400	
L	Without brake	279	329	379	429	479	529	579	629
	With brake	318	368	418	468	518	568	618	668
M	122	172	222	272	322	372	422	472	
N	50	100	100	200	200	300	300	400	
P	35	85	85	185	185	285	285	385	
R	22	22	72	22	72	22	72	22	
U	-	1	1	2	2	3	3	4	
m	4	4	4	6	6	8	8	10	
Weight (kg)	0.7	0.8	0.9	1	1.1	1.2	1.3	1.4	

Applicable Controllers

RCS2CR-series actuators can be operated with the following controllers. Select an appropriate controller type according to your application.

Name	External view	Model number	Features	Maximum number of positioning points	Input power	Power supply capacity	Standard price	Reference page	
Positioner mode		SCON-CA-20-1-NP-2-11	Up to 512 positioning points are supported.	512 points	Single-phase 100VAC	106 VA max.	—	→ P643	
Solenoid valve mode			Actuators can be operated through the same control used for solenoid valves.	7 points					
Field network type			Movement by numerical specification is supported.	768 points					
Pulse-train input control type		MCON-C-1-20-1-V-0-11	Dedicated pulse-train input type	(—)	Single-phase 200VAC	* Power supply capacity will vary depending on the controller, so please refer to the instruction manual for details.	—	→ P655	
Positioner multi-axis, network type			Up to 6 axes can be operated. Movement by numerical specification is supported.	256 points	3-phase 200VAC (XSEL-P/Q/R/S ONLY)				
Program control type, 1 to 2 axes			Program operation is supported. Up to 2 axes can be operated.	20,000 points	—				→ P685
Program control type, 1 to 8 axes			Program operation is supported. Up to 8 axes can be operated.	Varies depending on the number of axes connected	—				→ P695

* This is for the single-axis MCON, SSEL, and XSEL.

11 indicates the power-supply voltage type (1: 100V / 2: Single-phase 200V).

V indicates the power-supply voltage type (1: 100V / 2: Single-phase 200V / 3: Three-phase 200V).

1 indicates the encoder type (I: Incremental / A: Absolute).

11 indicates the XSEL type (J / K / P / Q / R / S).

V indicates field network specification symbol.

RCS2CR-SA4C 480

Sold & Serviced By:

Toll Free Phone (877) SERV098

Toll Free Fax (877) SERV099

www.electromate.com

sales@electromate.com

Slider Type

Mini

Standard

Controllers Integrated

Rod Type

Mini

Standard

Controllers Integrated

Table/Arm/Flat Type

Mini

Standard

Gripper/Rotary Type

Linear Servo Type

Clean-room Type

Splash-Proof Type

Pulse Motor

Servo Motor (24V)

Servo Motor (200V)

Linear Servo Motor

RCS2CR-SA5C

Cleanroom Robo Cylinder, Slider Type, Coupled, Actuator Width 52mm, 200V Servo Motor, Aluminum Base

Model Specification Items	RCS2CR— SA5C	—	—	20	—	—	—	—	—	—
	Series	Type	Encoder type	Motor type	Lead	Stroke	Applicable controller	Cable length	Options	
			I: Incremental A: Absolute	20: 20W Servo motor	20 : 20mm 12 : 12mm 6 : 6mm 3 : 3mm	50: 50mm ? 500: 500mm (50mm pitch increments)	T1: XSEL-J/K T2: SCON MSCON SSEL XSEL-P/Q XSEL-R/S	N: None P: 1m S: 3m M: 5m X□□: Custom length R□□: Robot cable	See options below.	

* See page Pre-47 for details on the model descriptions.



*CE compliance is optional.



Technical References Appendix P.5



- (1) When the stroke increases, the maximum will drop to prevent the ball screw from reaching the critical rotational speed. Use the actuator specification table below to check the maximum speed at the stroke you desire.
- (2) The load capacity is based on operation at an acceleration of 0.3G (0.2G for the 3mm-lead model). These values are the upper limits for the acceleration.
- (3) See page A-71 for details on push motion.

*This product is equipped with a position adjusting screw at the A area shown above. (See dimensional drawing on the page to the right.)

Actuator Specifications

Lead and Payload

Model number	Motor output (W)	Lead (mm)	Max. Load Capacity		Rated thrust (N)	Stroke (mm)
			Horizontal (kg)	Vertical (kg)		
RCS2CR-SA5C-①-20-20-②-③-④-⑤	20	20	2	0.5	10.7	50~500 (every 50mm)
RCS2CR-SA5C-①-20-12-②-③-④-⑤		12	4	1	16.7	
RCS2CR-SA5C-①-20-6-②-③-④-⑤		6	8	2	33.3	
RCS2CR-SA5C-①-20-3-②-③-④-⑤		3	2	4	65.7	

Stroke and Max. Speed/Suction Volume by Lead (Unit: mm/s)

Stroke Lead	50~450 (every 50mm)		500 (mm)	Suction Volume (Nℓ/min)
	50~450 (every 50mm)	500 (mm)	500 (mm)	
20	1300 <800>	1300 <800>	1300 <800>	80
12	800	760	760	50
6	800	380	380	30
3	200	190	190	15

Code explanation ① Encoder ② Stroke ③ Applicable Controller ④ Cable length ⑤ Options *See page A-71 for details on push motion. *The values enclosed in < > apply to vertical settings.

① Encoder type/② Stroke

② Stroke (mm)	Standard price	
	① Encoder Type	
	Incremental	Absolute
	I	A
50	—	—
100	—	—
150	—	—
200	—	—
250	—	—
300	—	—
350	—	—
400	—	—
450	—	—
500	—	—

④ Cable Length

Type	Cable symbol	Standard price
Standard	P (1m)	—
	S (3m)	—
	M (5m)	—
Special length	X06 (6m) ~ X10 (10m)	—
	X11 (11m) ~ X15 (15m)	—
	X16 (16m) ~ X20 (20m)	—
	R01 (1m) ~ R03 (3m)	—
Robot Cable	R04 (4m) ~ R05 (5m)	—
	R06 (6m) ~ R10 (10m)	—
	R11 (11m) ~ R15 (15m)	—
	R16 (16m) ~ R20 (20m)	—
	R16 (16m) ~ R20 (20m)	—

* See page A-59 for cables for maintenance.

⑤ Options

Name	Option code	See page	Standard price
Brake	B	→ A-42	—
CE compliance	CE	→ A-42	—
Foot bracket	FT	→ A-48	—
Home sensor	HS	→ A-50	—
Non-motor end specification	NM	→ A-52	—
Vacuum port on opposite side	VR	→ A-58	—

Actuator Specifications

Item	Description
Drive System	Ball screw, ø10mm, rolled C10
Positioning repeatability	±0.02mm
Lost Motion	0.1mm or less
Base	Material: Aluminum, white alumite treated
Allowable static moment	Ma: 18.6 N·m, Mb: 26.6 N·m, Mc: 47.5 N·m
Allowable dynamic moment (*)	Ma: 4.9 N·m, Mb: 6.8 N·m, Mc: 11.7 N·m
Allowable overhang	150mm or less in Ma, Mb and Mc directions
Grease Type	Low dust generation grease (both ball screw and guide)
Cleanliness	Class 10 (0.1µm)
Ambient operating temperature, humidity	0 to 40°C, 85% RH or less (Non-condensing)

(*) Based on 5,000km of traveling life

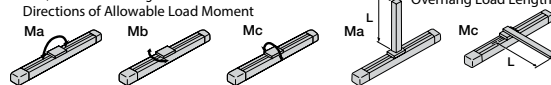

481 RCS2CR-SA5C

Dimensional Drawings

For Special Orders Appendix P.15

- (*1) Connect the motor and encoder cables here. See page A-59 for details on cables.
- (*2) After homing, the slider moves to the ME, therefore, please watch for any interference with surrounding objects.
ME : Mechanical end SE : Stroke end
- (*3) Reference position for calculating the moment Ma.

- (*4) If the actuator is secured using only the mounting holes provided on the top surface of the base, the base may twist to cause abnormal sliding of the slider, or may produce abnormal noise. Therefore, when using the mounting holes on the top surface of the base, keep the stroke at 300mm or less.

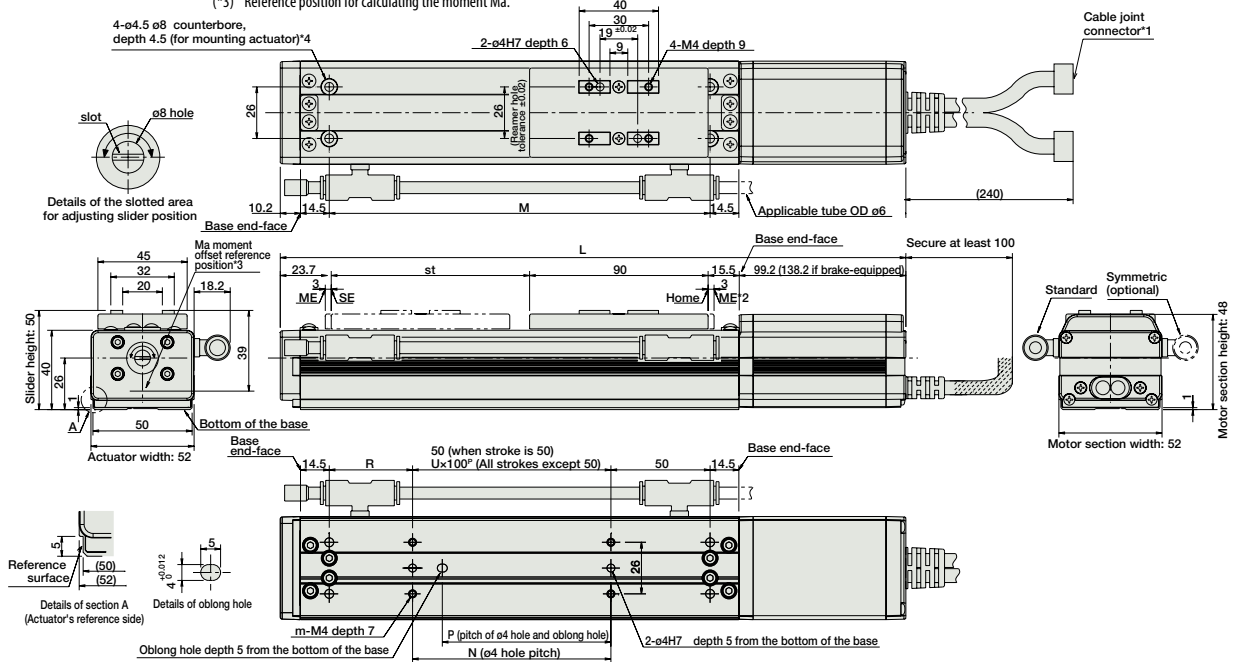

Dimensions and Weight by Stroke

* Brake-equipped models are heavier by 0.3kg.

Stroke	50	100	150	200	250	300	350	400	450	500	
L	Without brake	280.4	330.4	380.4	430.4	480.4	530.4	580.4	630.4	680.4	730.4
	With brake	319.4	369.4	419.4	469.4	519.4	569.4	619.4	669.4	719.4	769.4
M	142	192	242	292	342	392	442	492	542	592	
N	50	100	100	200	200	300	300	400	400	500	
P	35	85	85	185	185	285	285	385	385	485	
R	42	42	92	42	92	42	92	42	92	42	
U	-	1	1	2	2	3	3	4	4	5	
m	4	4	4	6	6	8	8	10	10	12	
Weight (kg)	1.3	1.4	1.5	1.6	1.7	1.8	1.9	2	2.1	2.2	

Applicable Controllers

RCS2CR-series actuators can be operated with the following controllers. Select an appropriate controller type according to your application.

Name	External view	Model number	Features	Maximum number of positioning points	Input power	Power supply capacity	Standard price	Reference page
Positioner mode		SCON-CA-20①-NP-2-①①	Up to 512 positioning points are supported.	512 points	Single-phase 100VAC	106 VA max.	—	→ P643
Solenoid valve mode			Actuators can be operated through the same control used for solenoid valves.	7 points				
Field network type			Movement by numerical specification is supported.	768 points				
Pulse-train input control type			Dedicated pulse-train input type	(—)	Single-phase 200VAC			
Positioner multi-axis, network type		MSCON-C-1-20①-④-0-①①	Up to 6 axes can be operated. Movement by numerical specification is supported.	256 points	3-phase 200VAC (XSEL-P/Q/R/S ONLY)			→ P655
Program control type, 1 to 2 axes		SSEL-CS-1-20①-NP-2-①①	Program operation is supported. Up to 2 axes can be operated.	20,000 points				→ P685
Program control type, 1 to 8 axes		XSEL-①①-1-20①-N1-EEE-2-④	Program operation is supported. Up to 8 axes can be operated.	Varies depending on the number of axes connected				→ P695

* This is for the single-axis MSCON, SSEL, and XSEL.

* ① indicates the power-supply voltage type (1: 100V / 2: Single-phase 200V).

* ④ indicates the power-supply voltage type (1: 100V / 2: Single-phase 200V / 3: Three-phase 200V).

* ① indicates the encoder type (I: Incremental / A: Absolute).

* ①① indicates the XSEL type (J / K / P / Q / R / S).

* ④ indicates field network specification symbol.

IAI

RCS2CR-SA5C

482

Sold & Serviced By:

ELECTROMATE

Toll Free Phone (877) SERV098

Toll Free Fax (877) SERV099

www.electromate.com

sales@electromate.com

Slider Type

Mini

Standard

Controllers Integrated

Rod Type

Mini

Standard

Controllers Integrated

Table/ Arm/ Flat Type

Mini

Standard

Gripper/ Rotary Type

Linear Servo Type

Clean-room Type

Splash-Proof Type

Pulse Motor

Servo Motor (24V)

Servo Motor (200V)

Linear Servo Motor

RCS2CR-SA6C

Cleanroom Robo Cylinder, Slider Type, Coupled, Actuator Width 58mm, 200V Servo Motor, Aluminum Base

Model Specification Items	RCS2CR	SA6C	30						
	Series	Type	Encoder type	Motor type	Lead	Stroke	Applicable controller	Cable length	Options
			I: Incremental A: Absolute	30: 30W Servo motor	20: 20mm 12: 12mm 6: 6mm 3: 3mm	50: 50mm ? 600: 600mm (50mm pitch increments)	T1: XSEL-J/K T2: SCON MSCON SSEL XSEL-P/Q XSEL-R/S	N: None P: 1m S: 3m M: 5m X□□: Custom length R□□: Robot cable	See options below.

* See page Pre-47 for details on the model descriptions.



*CE compliance is optional.



Technical References Appendix P.5



- (1) When the stroke increases, the maximum will drop to prevent the ball screw from reaching the critical rotational speed. Use the actuator specification table below to check the maximum speed at the stroke you desire.
- (2) The load capacity is based on operation at an acceleration of 0.3G (0.2G for the 3mm-lead model). These values are the upper limits for the acceleration.
- (3) See page A-71 for details on push motion.

*This product is equipped with a position adjusting screw at the A area shown above. (See dimensional drawing on the page to the right.)

Actuator Specifications

Lead and Payload

Model number	Motor output (W)	Lead (mm)	Max. Load Capacity		Rated thrust (N)	Stroke (mm)
			Horizontal (kg)	Vertical (kg)		
RCS2CR-SA6C-①-30-20-②-③-④-⑤	30	20	3	0.5	15.8	50~600 (every 50mm)
RCS2CR-SA6C-①-30-12-②-③-④-⑤		12	6	1.5	24.2	
RCS2CR-SA6C-①-30-6-②-③-④-⑤		6	12	3	48.4	
RCS2CR-SA6C-①-30-3-②-③-④-⑤		3	18	6	96.8	

Stroke and Max. Speed/Suction Volume by Lead (Unit: mm/s)

Stroke Lead	Stroke (mm)					Suction Volume (Nl/min)
	50~450 (every 50mm)	500 mm	550 mm	600 mm	>800	
20	1300 <800>	1160 <800>	990 <800>	80	80	
12	800	760	640	540	50	
6	400	380	320	270	30	
3	200	190	160	135	15	

Code explanation ① Encoder ② Stroke ③ Applicable Controller ④ Cable length ⑤ Options *See page A-71 for details on push motion. *The values enclosed in < > apply to vertical settings.

① Encoder type/② Stroke

② Stroke (mm)	Standard price	
	① Encoder Type	
	Incremental	Absolute
50	—	—
100	—	—
150	—	—
200	—	—
250	—	—
300	—	—
350	—	—
400	—	—
450	—	—
500	—	—
550	—	—
600	—	—

⑤ Options

Name	Option code	See page	Standard price
Brake	B	→ A-42	—
CE compliance	CE	→ A-42	—
Foot bracket	FT	→ A-48	—
Home sensor	HS	→ A-50	—
Non-motor end specification	NM	→ A-52	—
Vacuum port on opposite side	VR	→ A-58	—

④ Cable Length

Type	Cable symbol	Standard price
Standard	P (1m)	—
	S (3m)	—
	M (5m)	—
Special length	X06 (6m) ~ X10 (10m)	—
	X11 (11m) ~ X15 (15m)	—
	X16 (16m) ~ X20 (20m)	—
	R01 (1m) ~ R03 (3m)	—
Robot Cable	R04 (4m) ~ R05 (5m)	—
	R06 (6m) ~ R10 (10m)	—
	R11 (11m) ~ R15 (15m)	—
	R16 (16m) ~ R20 (20m)	—

* See page A-59 for cables for maintenance.

Actuator Specifications

Item	Description
Drive System	Ball screw, ø10mm, rolled C10
Positioning repeatability	±0.02mm
Lost Motion	0.1mm or less
Base	Material: Aluminum, white alumite treated
Allowable static moment	Ma: 38.3 N·m, Mb: 54.7 N·m, Mc: 81.0 N·m
Allowable dynamic moment (*)	Ma: 8.9 N·m, Mb: 12.7 N·m, Mc: 18.6 N·m
Allowable overhang	220mm or less in Ma, Mb and Mc directions
Grease Type	Low dust generation grease (both ball screw and guide)
Cleanliness	Class 10 (0.1µm)
Ambient operating temperature, humidity	0 to 40°C, 85% RH or less (Non-condensing)

(*) Based on 5,000km of traveling life

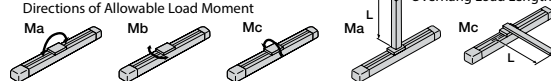

483 RCS2CR-SA6C

Dimensional Drawings

For Special Orders

Appendix P.15

- (*1) Connect the motor and encoder cables here. See page A-59 for details on cables.
- (*2) After homing, the slider moves to the ME, therefore, please watch for any interference with surrounding objects.
- ME : Mechanical end SE : Stroke end
- (*3) Reference position for calculating the moment Ma.

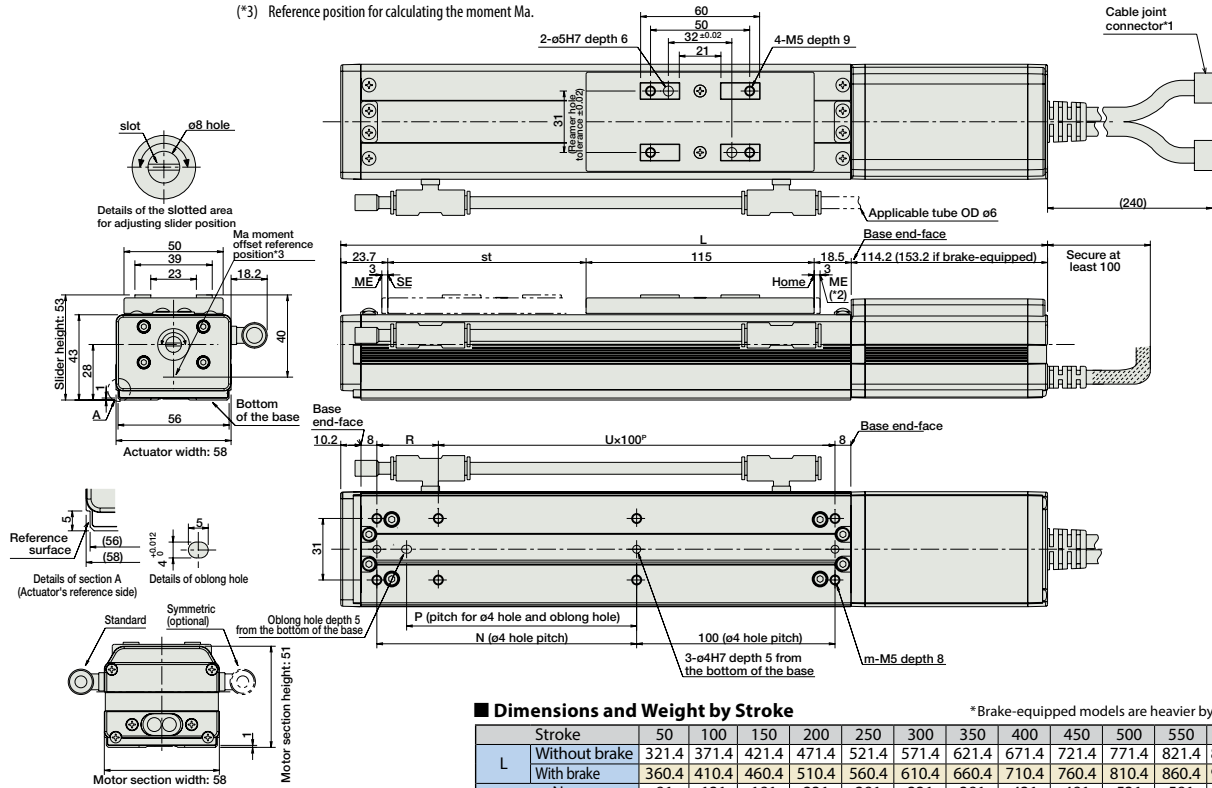

Dimensions and Weight by Stroke

* Brake-equipped models are heavier by 0.3kg.

Stroke	50	100	150	200	250	300	350	400	450	500	550	600	
L	Without brake	321.4	371.4	421.4	471.4	521.4	571.4	621.4	671.4	721.4	771.4	821.4	871.4
	With brake	360.4	410.4	460.4	510.4	560.4	610.4	660.4	710.4	760.4	810.4	860.4	910.4
N	81	131	181	231	281	331	381	431	481	531	581	631	
P	66	116	166	216	266	316	366	416	466	516	566	616	
R	81	31	81	31	81	31	81	31	81	31	81	31	
U	1	2	12	3	3	4	4	5	5	6	6	7	
m	6	8	8	10	10	12	12	14	14	16	16	18	
Weight (kg)	1.4	1.6	1.8	2	2.2	2.4	2.6	2.8	3	3.2	3.4	3.6	

Applicable Controllers

RCS2CR-series actuators can be operated with the following controllers. Select an appropriate controller type according to your application.

Name	External view	Model number	Features	Maximum number of positioning points	Input power	Power supply capacity	Standard price	Reference page
Positioner mode		SCON-CA-30D①-NP-2-①①	Up to 512 positioning points are supported.	512 points	Single-phase 100VAC	126 VA max.	—	→ P643
Solenoid valve mode			Actuators can be operated through the same control used for solenoid valves.	7 points				
Field network type			Movement by numerical specification is supported.	768 points				
Pulse-train input control type			Dedicated pulse-train input type	(—)	Single-phase 200VAC	*Power supply capacity will vary depending on the controller, so please refer to the instruction manual for details.	—	—
Positioner multi-axis, network type	MSCON-C-1-30D①-V-0-①①	Up to 6 axes can be operated. Movement by numerical specification is supported.	256 points	3-phase 200VAC (XSEL-P/Q/R/S ONLY)	→ P655			
Program control type, 1 to 2 axes	SSEL-CS-1-30D①-NP-2-①①	Program operation is supported. Up to 2 axes can be operated.	20,000 points	—	→ P685			
Program control type, 1 to 8 axes	XSEL-①①-1-30D①-N1-EEE-2-①①	Program operation is supported. Up to 8 axes can be operated.	Varies depending on the number of axes connected	—	—	→ P695		

* This is for the single-axis MSCON, SSEL, and XSEL.

① indicates the power-supply voltage type (1: 100V / 2: Single-phase 200V).

①① indicates the power-supply voltage type (1: 100V / 2: Single-phase 200V / 3: Three-phase 200V).

① indicates the encoder type (I: Incremental / A: Absolute).

①① indicates the XSEL type (J / K / P / Q / R / S).

①① indicates field network specification symbol.

IAI

RCS2CR-SA6C

484

Sold & Serviced By:

ELECTROMATE

Toll Free Phone (877) SERV098

Toll Free Fax (877) SERV099

www.electromate.com

sales@electromate.com

RCS2CR-SA7C

Cleanroom Robo Cylinder, Slider Type, Coupled, Actuator Width 73mm, 200V Servo Motor, Aluminum Base

Model Specification Items	RCS2CR— SA7C	—	Encoder type	—	Motor type	—	Lead	—	Stroke	—	Applicable controller	—	Cable length	—	Options
	Series — Type		I: Incremental A: Absolute		60: 60W Servo motor		16: 16mm 8: 8mm 4: 4mm		50: 50mm 800: 800mm (50mm pitch increments)		T1: XSEL-J/K T2: SCON MSCON SSEL XSEL-P/Q XSEL-R/S		N: None P: 1m S: 3m M: 5m X□□: Custom length R□□: Robot cable		See options below.

* See page Pre-47 for details on the model descriptions.



Technical References Appendix P.5

- POINT** Notes on selection
- When the stroke increases, the maximum will drop to prevent the ball screw from reaching the critical rotational speed. Use the actuator specification table below to check the maximum speed at the stroke you desire.
 - The load capacity is based on operation at an acceleration of 0.3G (0.2G for the 4mm-lead model). These values are the upper limits for the acceleration.
 - The cleanliness class 10 is for horizontal usage. Please note that the actuator may not support C10 when used on its side or in vertical orientation.
 - See page A-71 for details on push motion.

Actuator Specifications						Stroke and Max. Speed/Suction Volume by Lead				
Lead and Payload						Stroke (mm)	50~600 (every 50mm)	~700 (mm)	~800 (mm)	Suction Volume (Nℓ/min)
Model number	Motor output (W)	Lead (mm)	Max. Load Capacity (Horizontal (kg) / Vertical (kg))	Rated thrust (N)	Stroke (mm)					
RCS2CR-SA7C-①-60-16-②-③-④-⑤	60	16	12 / 3	63.8	50~800 (every 50mm)	16	800	640	480	50
RCS2CR-SA7C-①-60-8-②-③-④-⑤		8	25 / 6	127.5		8	400	320	240	30
RCS2CR-SA7C-①-60-4-②-③-④-⑤		4	40 / 12	255.0		4	200	160	120	10

Code explanation ① Encoder ② Stroke ③ Applicable Controller ④ Cable length ⑤ Options *See page A-71 for details on push motion. (Unit: mm/s)

② Stroke (mm)	Standard price	
	① Encoder Type	
	Incremental	Absolute
50/100	—	—
150/200	—	—
250/300	—	—
350/400	—	—
450/500	—	—
550/600	—	—
650/700	—	—
750/800	—	—

Type	Cable symbol	Standard price
Standard	P (1m)	—
	S (3m)	—
	M (5m)	—
Special length	X06 (6m) ~ X10 (10m)	—
	X11 (11m) ~ X15 (15m)	—
	X16 (16m) ~ X20 (20m)	—
	R01 (1m) ~ R03 (3m)	—
Robot Cable	R04 (4m) ~ R05 (5m)	—
	R06 (6m) ~ R10 (10m)	—
	R11 (11m) ~ R15 (15m)	—
	R16 (16m) ~ R20 (20m)	—
	R16 (16m) ~ R20 (20m)	—

* See page A-59 for cables for maintenance.

⑤ Options			
Name	Option code	See page	Standard price
Brake (cable exiting from end)	BE	→ A-42	—
Brake (cable exiting from left)	BL	→ A-42	—
Brake (cable exiting from right)	BR	→ A-42	—
CE compliance	CE	→ A-42	—
Non-motor end specification	NM	→ A-52	—
Vacuum port on opposite side	VR	→ A-58	—

Actuator Specifications	
Item	Description
Drive System	Ball screw, ø12mm, rolled C10
Positioning repeatability	±0.02mm
Lost Motion	0.1mm or less
Base	Material: Aluminum, white alumite treated
Allowable static moment	Ma: 50.4 N·m, Mb: 71.9 N·m, Mc: 138.0 N·m
Allowable dynamic moment (*)	Ma: 13.9 N·m, Mb: 19.9 N·m, Mc: 38.3 N·m
Allowable overhang	230mm or less in Ma, Mb and Mc directions
Grease Type	Low dust generation grease (both ball screw and guide)
Cleanliness	Class 10 (0.1µm)
Ambient operating temperature, humidity	0 to 40°C, 85% RH or less (Non-condensing)

(*) Based on 5,000km of traveling life

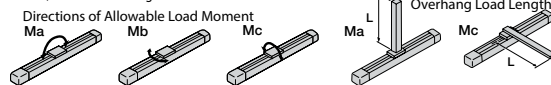

485 RCS2CR-SA7C

Dimensional Drawings

*For the non-motor end model, the dimensions (distance to home) on the motor-side and that on the opposite side are flipped.

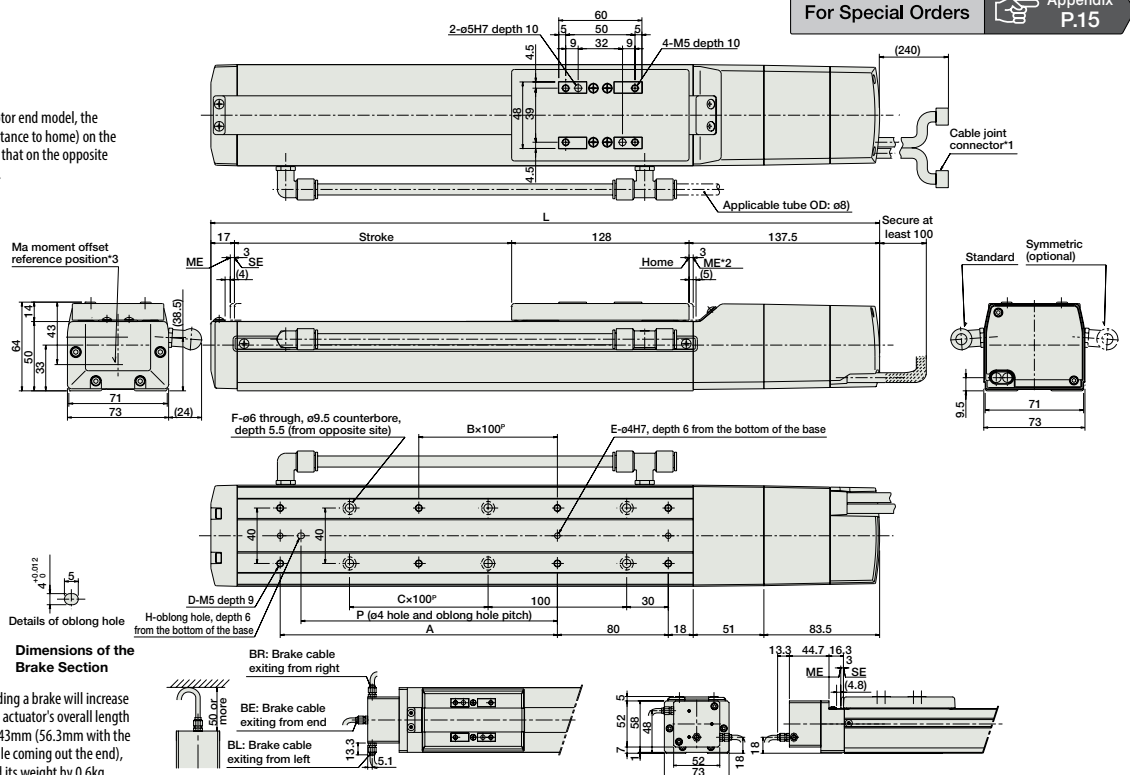

*Adding a brake will increase the actuator's overall length by 43mm (56.3mm with the cable coming out the end), and its weight by 0.6kg.

Dimensions and Weight by Stroke

Stroke	50	100	150	200	250	300	350	400	450	500	550	600	650	700	750	800
L	332.5	382.5	432.5	482.5	532.5	582.5	632.5	682.5	732.5	782.5	832.5	882.5	932.5	982.5	1032.5	1082.5
A	0	100	100	200	200	300	300	400	400	500	500	600	600	700	700	800
B	0	0	0	1	1	2	2	3	3	4	4	5	5	6	6	7
C	0	0	1	1	2	2	3	3	4	4	5	5	6	6	7	7
D	4	6	6	8	8	10	10	12	12	14	14	16	16	18	18	20
E	2	3	3	3	3	3	3	3	3	3	3	3	3	3	3	3
F	4	4	6	6	8	8	10	10	12	12	14	14	16	16	18	18
H	0	1	1	1	1	1	1	1	1	1	1	1	1	1	1	1
P	0	85	85	185	185	285	285	385	385	485	485	585	585	685	685	785
Weight (kg)	2.6	2.8	3.0	3.2	3.5	3.7	3.9	4.1	4.4	4.6	4.8	5.0	5.3	5.5	5.7	5.9

- (*1) Connect the motor and encoder cables here. See page A-59 for details on cables.
- (*2) After homing, the slider moves to the ME, therefore, please watch for any interference with surrounding objects. ME: Mechanical end SE: Stroke end The values enclosed in "()" are reference dimensions.
- (*3) Reference position for calculating the moment Ma.

Applicable Controllers

RCS2CR-series actuators can be operated with the following controllers. Select an appropriate controller type according to your application.

Name	External view	Model number	Features	Maximum number of positioning points	Input power	Power supply capacity	Standard price	Reference page
Positioner mode		SCON-CA-60①-NP-2-①①	Up to 512 positioning points are supported.	512 points	Single-phase 100VAC	218 VA max. *Power supply capacity will vary depending on the controller, so please refer to the instruction manual for details.	—	→ P643
Solenoid valve mode			Actuators can be operated through the same control used for solenoid valves.	7 points				
Field network type			Movement by numerical specification is supported.	768 points				
Pulse-train input control type			Dedicated pulse-train input type	(—)	Single-phase 200VAC			
Positioner multi-axis, network type		MSCON-C-1-60①-①-①-①	Up to 6 axes can be operated. Movement by numerical specification is supported.	256 points	3-phase 200VAC (XSEL-P/Q/R/S ONLY)		—	→ P655
Program control type, 1 to 2 axes		SSEL-CS-1-60①-NP-2-①①	Program operation is supported. Up to 2 axes can be operated.	20,000 points			—	→ P685
Program control type, 1 to 8 axes		XSEL-①①-1-60①-N1-EEE-2-①①	Program operation is supported. Up to 8 axes can be operated.	Varies depending on the number of axes connected			—	→ P695

* This is for the single-axis MSCON, SSEL, and XSEL.
 * ① indicates the power-supply voltage type (1: 100V / 2: Single-phase 200V).
 * ①① indicates the power-supply voltage type (1: 100V / 2: Single-phase 200V / 3: Three-phase 200V).
 * ① indicates the encoder type (I: Incremental / A: Absolute).
 * ①① indicates the XSEL type (J / K / P / Q / R / S).
 * ①① indicates field network specification symbol.

- Slider Type
- Mini
- Standard
- Controllers Integrated
- Rod Type
- Mini
- Standard
- Controllers Integrated
- Table/Arm/Flat Type
- Mini
- Standard
- Gripper/Rotary Type
- Linear Servo Type
- Clean-room Type
- Splash-Proof Type
- Pulse Motor
- Servo Motor (24V)
- Servo Motor (200V)
- Linear Servo Motor

RCS2CR-SS7C

Cleanroom Robo Cylinder, Slider Type, Coupled, Actuator Width 60mm, 200V Servo Motor, Steel Base

Model Specification Items	RCS2CR — SS7C	Encoder type	60	Lead	Stroke	Applicable controller	Cable length	Options
	Series — Type	I: Incremental A: Absolute	60: 60W Servo motor	12: 12mm 6: 6mm	50: 50mm 600: 600mm (50mm pitch increments)	T1: XSEL-J/K T2: SCON MSCON SSEL XSEL-P/Q XSEL-R/S	N: None P: 1m S: 3m M: 5m X□□: Custom length R□□: Robot cable	See options below.

* See page Pre-47 for details on the model descriptions.



*CE compliance is optional.



Technical References Appendix P.5



- (1) When the stroke increases, the maximum will drop to prevent the ball screw from reaching the critical rotational speed. Use the actuator specification table below to check the maximum speed at the stroke you desire.
- (2) The load capacity is based on operation at an acceleration of 0.3G. This is the upper limit for the acceleration.
- (3) See page A-71 for details on push motion.

Actuator Specifications

Lead and Payload

Model number	Motor output (W)	Lead (mm)	Max. Load Capacity		Rated thrust (N)	Stroke (mm)
			Horizontal (kg)	Vertical (kg)		
RCS2CR-SS7C-①-60-12-②-③-④-⑤	60	12	15	4	85	50-600 (every 50mm)
RCS2CR-SS7C-①-60-6-②-③-④-⑤		6	30	8		

Stroke and Max. Speed/Suction Volume by Lead

Stroke Lead	50-500 (every 50mm)	~600 (mm)	Suction Volume (Nℓ/min)
12	600	470	50
6	300	230	30

Code explanation ① Encoder ② Stroke ③ Applicable Controller ④ Cable length ⑤ Options *See page A-71 for details on push motion. (Unit: mm/s)

① Encoder type/② Stroke

② Stroke (mm)	Standard price	
	① Encoder Type	
	Incremental I	Absolute A
50/100	—	—
150/200	—	—
250/300	—	—
350/400	—	—
450/500	—	—
550/600	—	—

④ Cable Length

Type	Cable symbol	Standard price
Standard	P (1m)	—
	S (3m)	—
	M (5m)	—
Special length	X06 (6m) ~ X10 (10m)	—
	X11 (11m) ~ X15 (15m)	—
	X16 (16m) ~ X20 (20m)	—
	R01 (1m) ~ R03 (3m)	—
Robot Cable	R04 (4m) ~ R05 (5m)	—
	R06 (6m) ~ R10 (10m)	—
	R11 (11m) ~ R15 (15m)	—
	R16 (16m) ~ R20 (20m)	—

* See page A-59 for cables for maintenance.

⑤ Options

Name	Option code	See page	Standard price
Brake	B	→ A-42	—
CE compliance	CE	→ A-42	—
Non-motor end specification	NM	→ A-52	—
Vacuum port on opposite side	VR	→ A-58	—

Actuator Specifications

Item	Description
Drive System	Ball screw, ø10mm, rolled C10
Positioning repeatability	±0.02mm
Lost Motion	0.1mm or less
Base	Material: Special alloy steel
Allowable static moment	Ma: 79.4 N·m, Mb: 79.4 N·m, Mc: 172.9 N·m
Allowable dynamic moment (*)	Ma: 14.7 N·m, Mb: 14.7 N·m, Mc: 33.3 N·m
Allowable overhang	300mm or less in Ma, Mb and Mc directions
Grease Type	Low dust generation grease (both ball screw and guide)
Cleanliness	Class 10 (0.1µm)
Ambient operating temperature, humidity	0 to 40°C, 85% RH or less (Non-condensing)

(*) Based on 10,000km of traveling life

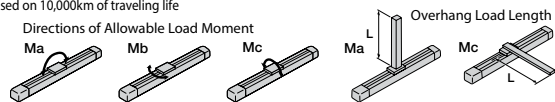

487 RCS2CR-SS7C

Dimensional Drawings

For Special Orders Appendix P.15

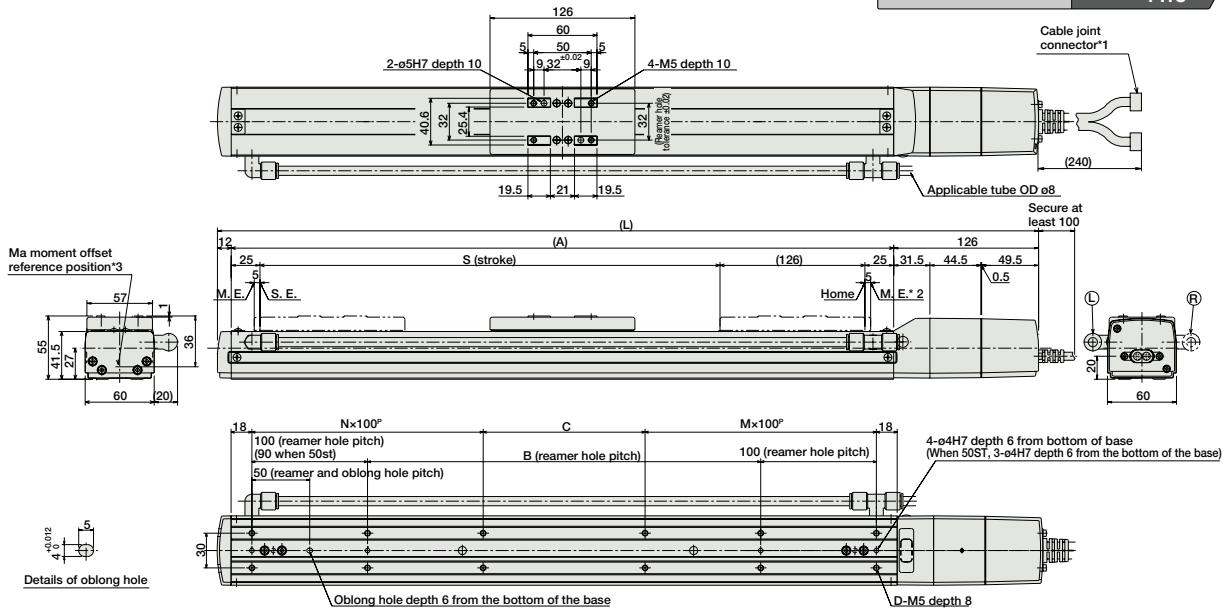

Dimensions of the Brake Section

*The length L of a brake-equipped actuator is longer than that of a standard model by 24.5mm; add 0.3kg to weight.

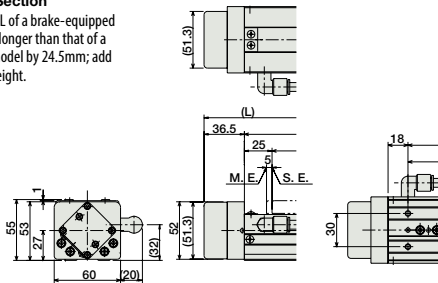

- (*1) Connect the motor and encoder cables here. See page A-59 for details on cables.
- (*2) After homing, the slider moves to the ME, therefore, please watch for any interference with surrounding objects.
ME: Mechanical end SE: Stroke end
The values enclosed in "()" are reference dimensions.
- (*3) Reference position for calculating the moment Ma.

■ Dimensions and Weight by Stroke

Stroke	50	100	150	200	250	300	350	400	450	500	550	600
L	364	414	464	514	564	614	664	714	764	814	864	914
A	226	276	326	376	426	476	526	576	626	676	726	776
B	0	40	90	140	190	240	290	340	390	440	490	540
C	90	40	90	140	190	40	90	140	190	40	90	140
D	6	8	8	8	8	12	12	12	12	16	16	16
M	1	1	1	1	1	2	2	2	2	3	3	3
N	0	1	1	1	1	2	2	2	2	3	3	3
Weight (kg)	3.1	3.4	3.7	4.0	4.4	4.7	5.0	5.3	5.7	6.0	6.3	6.6

③ Applicable Controllers

RCS2CR-series actuators can be operated with the following controllers. Select an appropriate controller type according to your application.

Name	External view	Model number	Features	Maximum number of positioning points	Input power	Power supply capacity	Standard price	Reference page	
Positioner mode		SCON-CA-60①-NP-2-①①	Up to 512 positioning points are supported.	512 points	Single-phase 100VAC Single-phase 200VAC 3-phase 200VAC (XSEL-P/Q/R/S ONLY)	218 VA max. *Power supply capacity will vary depending on the controller, so please refer to the instruction manual for details.	—	→ P643	
Solenoid valve mode			Actuators can be operated through the same control used for solenoid valves.	7 points					
Field network type			Movement by numerical specification is supported.	768 points					
Pulse-train input control type			Dedicated pulse-train input type	(—)					
Positioner multi-axis, network type		MSCON-C-1-60①-V①-0-①①	Up to 6 axes can be operated. Movement by numerical specification is supported.	256 points	—	—	→ P655		
Program control type, 1 to 2 axes		SSEL-CS-1-60①-NP-2-①①	Program operation is supported. Up to 2 axes can be operated.	20,000 points				—	→ P685
Program control type, 1 to 8 axes		XSEL-①①-1-60①-N1-EEE-2-V①	Program operation is supported. Up to 8 axes can be operated.	Varies depending on the number of axes connected					

* This is for the single-axis MSCON, SSEL, and XSEL.

* ① indicates the power-supply voltage type (1: 100V / 2: Single-phase 200V).

* V① indicates the power-supply voltage type (1: 100V / 2: Single-phase 200V / 3: Three-phase 200V).

* ① indicates the encoder type (I: Incremental / A: Absolute).

* ①① indicates the XSEL type (J / K / P / Q / R / S).

* V① indicates field network specification symbol.

Slider Type

Mini

Standard

Controllers Integrated

Rod Type

Mini

Standard

Controllers Integrated

Table/Arm/Flat Type

Mini

Standard

Gripper/Rotary Type

Linear Servo Type

Clean-room Type

Splash-Proof Type

Pulse Motor

Servo Motor (24V)

Servo Motor (200V)

Linear Servo Motor

RCS2CR-SA5D

Cleanroom Robo Cylinder, Slider, Built-in Type, Actuator Width 52mm, 200V Servo Motor, Aluminum Base

Model Specification Items	RCS2CR— SA5D	—	□	—	20	—	□	—	□	—	□	—	□	—	□	—	□	Options
	Series	Type	Encoder type	Motor type	Lead	Stroke	Applicable controller	Cable length	See options below.									
			I: Incremental A: Absolute	20: 20W Servo motor	12: 12mm 6: 6mm 3: 3mm	50: 50mm ? 500: 500mm (50mm pitch increments)	T1: XSEL-J/K T2: SCON MSCON SSEL XSEL-P/Q XSEL-R/S	N: None P: 1m S: 3m M: 5m X□□: Custom length R□□: Robot cable										

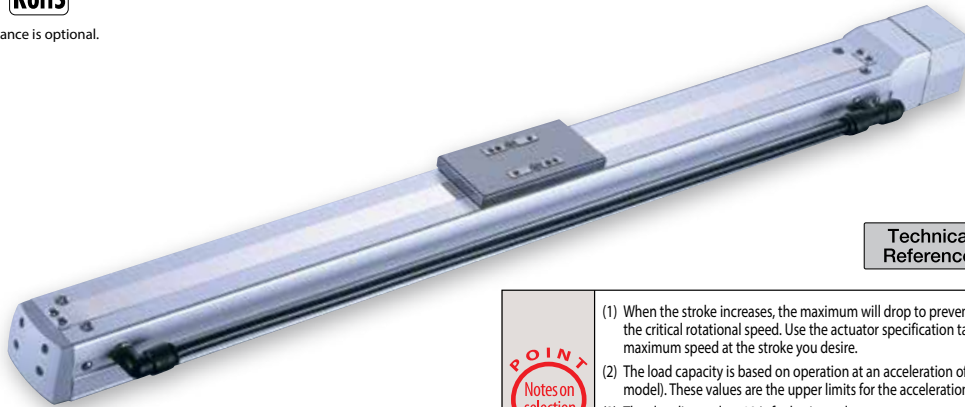

Technical References Appendix P.5

- POINT** Notes on selection
- When the stroke increases, the maximum will drop to prevent the ball screw from reaching the critical rotational speed. Use the actuator specification table below to check the maximum speed at the stroke you desire.
 - The load capacity is based on operation at an acceleration of 0.3G (0.2G for the 3mm-lead model). These values are the upper limits for the acceleration.
 - The cleanliness class 10 is for horizontal usage. Please note that the actuator may not support C10 when used on its side or in vertical orientation.
 - See page A-71 for details on push motion.

Actuator Specifications							Stroke and Max. Speed/Suction Volume by Lead			
Lead and Payload							Stroke Lead	50~450 (every 50mm)	500 (mm)	Suction Volume (Nℓ/min)
Model number	Motor output (W)	Lead (mm)	Max. Load Capacity		Rated thrust (N)	Stroke (mm)				
RCS2CR-SA5D-①-20-12-②-③-④-⑤	20	12	4	1	16.7	50~500 (every 50mm)	12	800	760	50
RCS2CR-SA5D-①-20-6-②-③-④-⑤		6	8	2	33.3		6	400	380	30
RCS2CR-SA5D-①-20-3-②-③-④-⑤		3	12	4	65.7		3	200	190	15

Code explanation ① Encoder ② Stroke ③ Applicable Controller ④ Cable length ⑤ Options *See page A-71 for details on push motion. (Unit: mm/s)

① Encoder type/② Stroke		
② Stroke (mm)	Standard price	
	① Encoder Type	
	Incremental	Absolute
50	—	—
100	—	—
150	—	—
200	—	—
250	—	—
300	—	—
350	—	—
400	—	—
450	—	—
500	—	—

④ Cable Length		
Type	Cable symbol	Standard price
Standard	P (1m)	—
	S (3m)	—
	M (5m)	—
Special length	X06 (6m) ~ X10 (10m)	—
	X11 (11m) ~ X15 (15m)	—
	X16 (16m) ~ X20 (20m)	—
Robot Cable	R01 (1m) ~ R03 (3m)	—
	R04 (4m) ~ R05 (5m)	—
	R06 (6m) ~ R10 (10m)	—
	R11 (11m) ~ R15 (15m)	—
	R16 (16m) ~ R20 (20m)	—

* See page A-59 for cables for maintenance.

⑤ Options			
Name	Option code	See page	Standard price
Brake (cable exiting from end)	BE	→ A-42	—
Brake (cable exiting from left)	BL	→ A-42	—
Brake (cable exiting from right)	BR	→ A-42	—
CE compliance	CE	→ A-42	—
Non-motor end specification	NM	→ A-52	—
Vacuum port on opposite side	VR	→ A-58	—

Actuator Specifications	
Item	Description
Drive System	Ball screw, ø10mm, rolled C10
Positioning repeatability	±0.02mm
Lost Motion	0.1mm or less
Base	Material: Aluminum, white alumite treated
Allowable static moment	Ma: 18.6 N·m, Mb: 26.6 N·m, Mc: 47.5 N·m
Allowable dynamic moment (*)	Ma: 4.9 N·m, Mb: 6.8 N·m, Mc: 11.7 N·m
Allowable overhang	150mm or less in Ma, Mb and Mc directions
Grease Type	Low dust generation grease (both ball screw and guide)
Cleanliness	Class 10 (0.1µm)
Ambient operating temperature, humidity	0 to 40°C, 85% RH or less (Non-condensing)

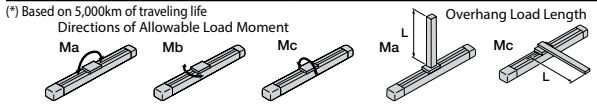

489 RCS2CR-SA5D

Dimensional Drawings

For Special Orders Appendix P.15

- (*1) Connect the motor and encoder cables here. See page A-59 for details on cables.
- (*2) After homing, the slider moves to the ME, therefore, please watch for any interference with surrounding objects.
ME : Mechanical end SE : Stroke end
The values enclosed in "() " are reference dimensions.
- (*3) Reference position for calculating the moment Ma.
- (*4) If the actuator is secured using only the mounting holes provided on the top surface of the base, the base may twist to cause abnormal sliding of the slider, or may produce abnormal noise. Therefore, when using the mounting holes on the top surface of the base, keep the stroke at 300mm or less.

* Note that in order to change the home orientation, arrangements must be made to send in the product to IAI.

* In the non-motor end model (NM), the new home position is set 3mm inward from the ME opposite of the motor-side.

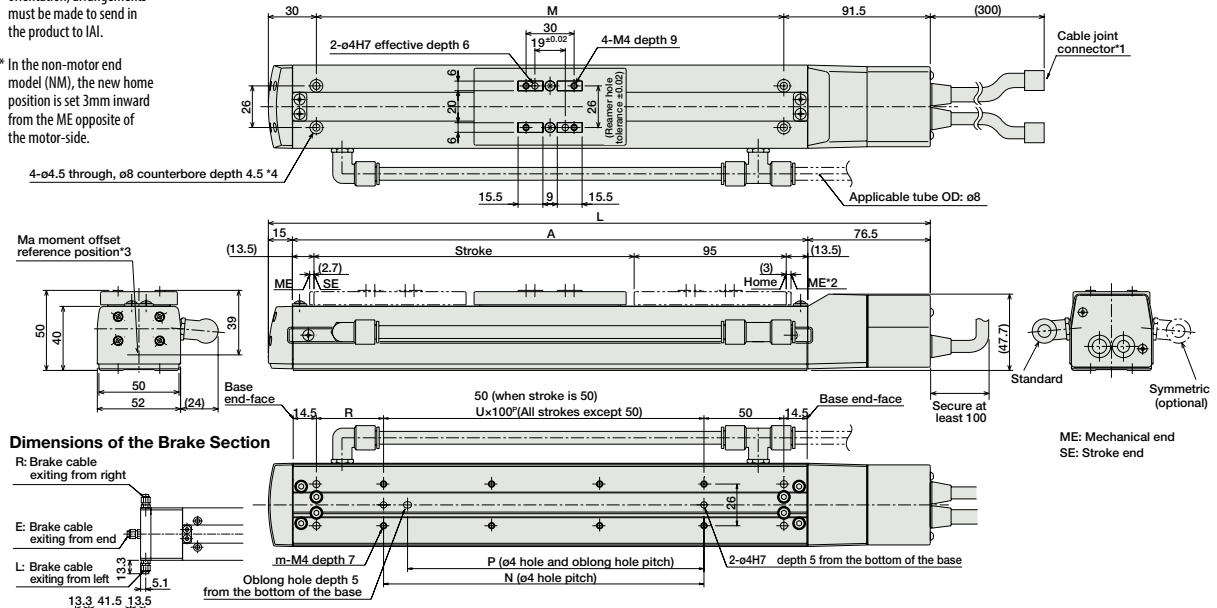

Dimensions and Weight by Stroke

Stroke	50	100	150	200	250	300	350	400	450	500
L	263.5	313.5	363.5	413.5	463.5	513.5	563.5	613.5	663.5	713.5
A	172	222	272	322	372	422	472	522	572	622
M	142	192	242	292	342	392	442	492	542	592
N	50	100	100	200	200	300	300	400	400	500
P	35	85	85	185	185	285	285	385	385	485
R	42	42	92	42	92	42	92	42	92	42
U	-	1	1	2	2	3	3	4	4	5
m	4	4	4	6	6	8	8	10	10	12
Weight (kg)	1.5	1.6	1.7	1.8	1.9	2.0	2.1	2.2	2.3	2.5

* Adding a brake will increase the actuator's overall length by 26.5mm (39.8mm with the cable coming out the end), and its weight by 0.3kg.

Applicable Controllers

RCS2CR-series actuators can be operated with the following controllers. Select an appropriate controller type according to your application.

Name	External view	Model number	Features	Maximum number of positioning points	Input power	Power supply capacity	Standard price	Reference page
Positioner mode		SCON-CA-20①-NP-2-①①	Up to 512 positioning points are supported.	512 points	Single-phase 100VAC	106 VA max. *Power supply capacity will vary depending on the controller, so please refer to the instruction manual for details.	—	→ P643
Solenoid valve mode			Actuators can be operated through the same control used for solenoid valves.	7 points				
Field network type			Movement by numerical specification is supported.	768 points				
Pulse-train input control type			Dedicated pulse-train input type	(—)	Single-phase 200VAC			
Positioner multi-axis, network type		MSCON-C-1-20①-④-0-①①	Up to 6 axes can be operated. Movement by numerical specification is supported.	256 points	3-phase 200VAC (XSEL-P/Q/R/S ONLY)		—	→ P655
Program control type, 1 to 2 axes		SSEL-CS-1-20①-NP-2-①①	Program operation is supported. Up to 2 axes can be operated.	20,000 points			—	→ P685
Program control type, 1 to 8 axes		XSEL-①①-1-20①-N1-EEE-2-④	Program operation is supported. Up to 8 axes can be operated.	Varies depending on the number of axes connected			—	→ P695

* This is for the single-axis MSCON, SSEL, and XSEL.
 * ① indicates the power-supply voltage type (1: 100V / 2: Single-phase 200V).
 * ①① indicates the XSEL type (J / K / P / Q / R / S).
 * ④ indicates the power-supply voltage type (1: 100V / 2: Single-phase 200V / 3: Three-phase 200V).
 * ④ indicates field network specification symbol.

- Slider Type
- Mini
- Standard
- Controllers Integrated
- Rod Type
- Mini
- Standard
- Controllers Integrated
- Table/ Arm/ Flat Type
- Mini
- Standard
- Gripper/ Rotary Type
- Linear Servo Type
- Clean-room Type
- Splash-Proof Type
- Pulse Motor
- Servo Motor (24V)
- Servo Motor (200V)
- Linear Servo Motor



RCS2CR-SA5D 490

RCS2CR-SA6D

Cleanroom Robo Cylinder, Slider, Built-in Type, Actuator Width 58mm, 200V Servo Motor, Aluminum Base

Model Specification Items	RCS2CR— SA6D	—	30	—	—	—	—	—	—
	Series — Type	Encoder type	Motor type	Lead	Stroke	Applicable controller	Cable length	Options	
		I: Incremental A: Absolute	30: 30W Servo motor	12: 12mm 6: 6mm 3: 3mm	50: 50mm ? 600: 600mm (50mm pitch increments)	T1: XSEL-J/K T2: SCON MSCON SSEL XSEL-P/Q XSEL-R/S	N: None P: 1m S: 3m M: 5m X□□: Custom length R□□: Robot cable	See options below.	

* See page Pre-47 for details on the model descriptions.



*CE compliance is optional.

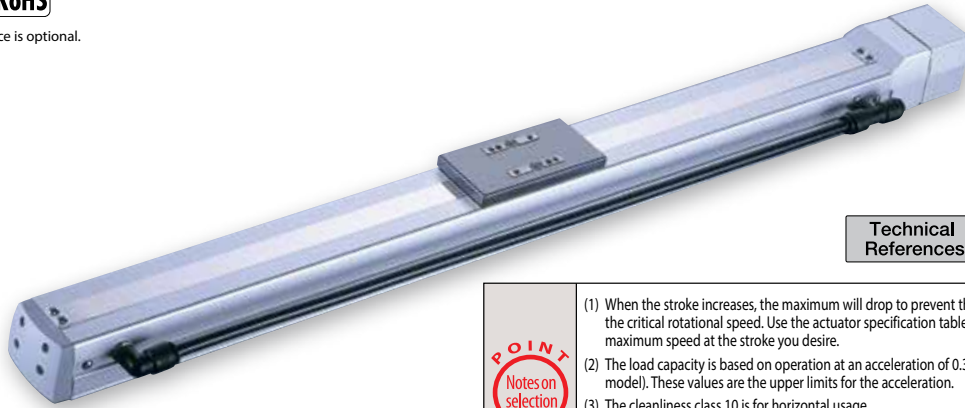

Technical References Appendix P.5

- POINT** Notes on selection
- When the stroke increases, the maximum will drop to prevent the ball screw from reaching the critical rotational speed. Use the actuator specification table below to check the maximum speed at the stroke you desire.
 - The load capacity is based on operation at an acceleration of 0.3G (0.2G for the 3mm-lead model). These values are the upper limits for the acceleration.
 - The cleanliness class 10 is for horizontal usage. Please note that the actuator may not support C10 when used on its side or in vertical orientation.
 - See page A-71 for details on push motion.

Actuator Specifications

Lead and Payload

Model number	Motor output (W)	Lead (mm)	Max. Load Capacity		Rated thrust (N)	Stroke (mm)
			Horizontal (kg)	Vertical (kg)		
RCS2CR-SA6D-①-30-12-②-③-④-⑤	30	12	6	1.5	24.2	50~600 (every 50mm)
RCS2CR-SA6D-①-30-6-②-③-④-⑤		6	12	3	48.4	
RCS2CR-SA6D-①-30-3-②-③-④-⑤		3	18	6	96.8	

Stroke and Max. Speed/Suction Volume by Lead

Stroke / Lead	Stroke (mm)				Suction Volume (N ₂ /min)
	50~450 (every 50mm)	500 mm	550 mm	600 mm	
12	800	760	640	540	50
6	400	380	320	270	30
3	200	190	160	135	15

Code explanation ① Encoder ② Stroke ③ Applicable Controller ④ Cable length ⑤ Options *See page A-71 for details on push motion. (Unit: mm/s)

① Encoder type/② Stroke

② Stroke (mm)	Standard price	
	① Encoder type	
	Incremental	Absolute
	I	A
50	—	—
100	—	—
150	—	—
200	—	—
250	—	—
300	—	—
350	—	—
400	—	—
450	—	—
500	—	—
550	—	—
600	—	—

④ Cable Length

Type	Cable symbol	Standard price
Standard	P (1m)	—
	S (3m)	—
	M (5m)	—
Special length	X06 (6m) ~ X10 (10m)	—
	X11 (11m) ~ X15 (15m)	—
	X16 (16m) ~ X20 (20m)	—
	R01 (1m) ~ R03 (3m)	—
Robot Cable	R04 (4m) ~ R05 (5m)	—
	R06 (6m) ~ R10 (10m)	—
	R11 (11m) ~ R15 (15m)	—
	R16 (16m) ~ R20 (20m)	—

* See page A-59 for cables for maintenance.

⑤ Options

Name	Option code	See page	Standard price
Brake (cable exiting from end)	BE	→ A-42	—
Brake (cable exiting from left)	BL	→ A-42	—
Brake (cable exiting from right)	BR	→ A-42	—
CE compliance	CE	→ A-42	—
Non-motor end specification	NM	→ A-52	—
Vacuum port on opposite side	VR	→ A-58	—

Actuator Specifications

Item	Description
Drive System	Ball screw, ø10mm, rolled C10
Positioning repeatability	±0.02mm
Lost Motion	0.1mm or less
Base	Material: Aluminum, white alumite treated
Allowable static moment	Ma: 38.3 N·m, Mb: 54.7 N·m, Mc: 81.0 N·m
Allowable dynamic moment (*)	Ma: 8.9 N·m, Mb: 12.7 N·m, Mc: 18.6 N·m
Allowable overhang	220mm or less in Ma, Mb and Mc directions
Grease Type	Low dust generation grease (both ball screw and guide)
Cleanliness	Class 10 (0.1µm)
Ambient operating temperature, humidity	0 to 40°C, 85% RH or less (Non-condensing)

(*) Based on 5,000km of traveling life

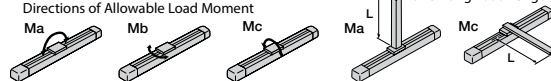

491 RCS2CR-SA6D

Dimensional Drawings

For Special Orders Appendix P.15

(*1) Connect the motor and encoder cables here. See page A-59 for details on cables.
 (*2) After homing, the slider moves to the ME, therefore, please watch for any interference with surrounding objects.

* Note that in order to change the home orientation, arrangements must be made to send in the product to IAI.

* In the non-motor end model (NM), the new home position is set 3mm inward from the ME opposite of the motor-side.

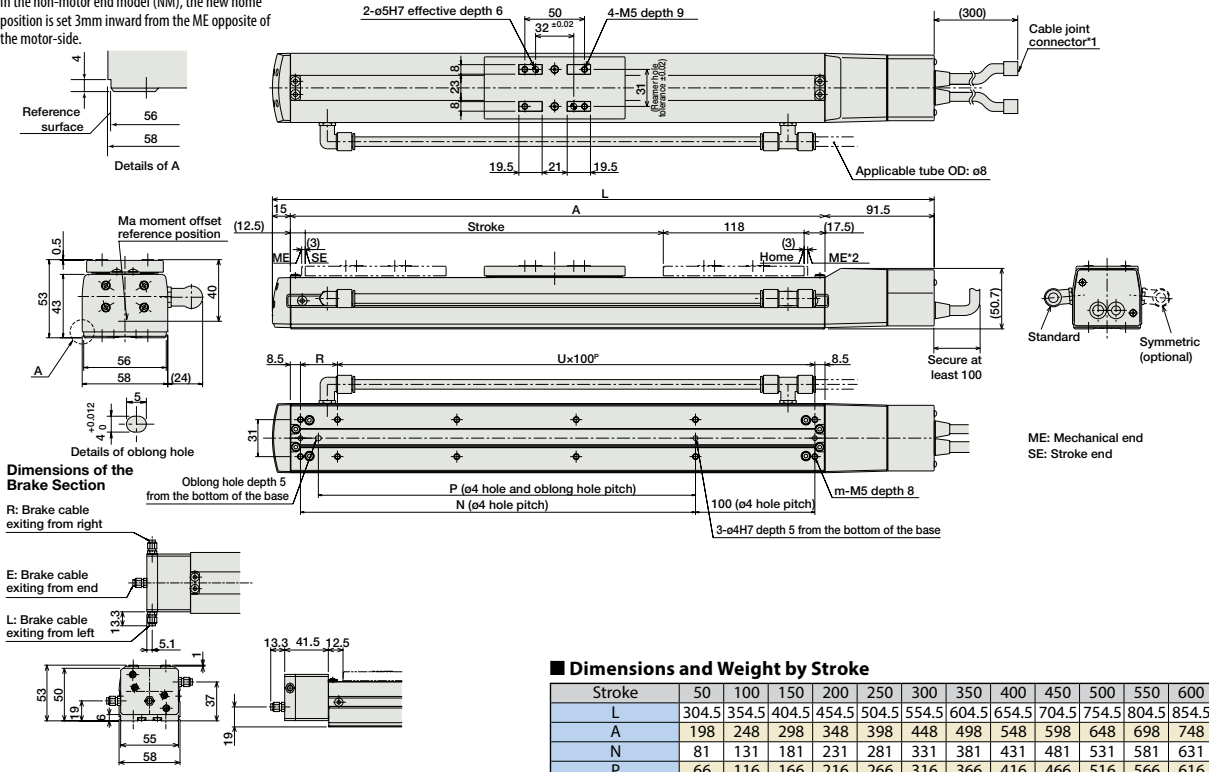

■ Dimensions and Weight by Stroke

Stroke	50	100	150	200	250	300	350	400	450	500	550	600
L	304.5	354.5	404.5	454.5	504.5	554.5	604.5	654.5	704.5	754.5	804.5	854.5
A	198	248	298	348	398	448	498	548	598	648	698	748
N	81	131	181	231	281	331	381	431	481	531	581	631
P	66	116	166	216	266	316	366	416	466	516	566	616
R	81	31	81	31	81	31	81	31	81	31	81	31
U	1	2	2	3	3	4	4	5	5	6	6	7
m	6	8	8	10	10	12	12	14	14	16	16	18
Weight (kg)	2.0	2.1	2.3	2.4	2.6	2.7	2.9	3.0	3.2	3.3	3.5	3.6

* Adding a brake will increase the actuator's overall length by 26.5mm (39.8mm with the cable coming out the end), and its weight by 0.3kg.

③ Applicable Controllers

RCS2CR-series actuators can be operated with the following controllers. Select an appropriate controller type according to your application.

Name	External view	Model number	Features	Maximum number of positioning points	Input power	Power supply capacity	Standard price	Reference page
Positioner mode		SCON-CA-30D①-NP-2-②	Up to 512 positioning points are supported.	512 points	Single-phase 100VAC Single-phase 200VAC 3-phase 200VAC (XSEL-P/Q/R/S ONLY)	126 VA max. *Power supply capacity will vary depending on the controller, so please refer to the instruction manual for details.	—	→ P643
Solenoid valve mode			Actuators can be operated through the same control used for solenoid valves.	7 points				
Field network type			Movement by numerical specification is supported.	768 points				
Pulse-train input control type			Dedicated pulse-train input type	(—)				
Positioner multi-axis, network type		MSCON-C-1-30D①-V-0-②	Up to 6 axes can be operated. Movement by numerical specification is supported.	256 points			—	→ P655
Program control type, 1 to 2 axes		SSEL-CS-1-30D①-NP-2-②	Program operation is supported. Up to 2 axes can be operated.	20,000 points			—	→ P685
Program control type, 1 to 8 axes		XSEL-③-1-30D①-N1-EEE-2-④	Program operation is supported. Up to 8 axes can be operated.	Varies depending on the number of axes connected			—	→ P695

* This is for the single-axis MSCON, SSEL, and XSEL.

① indicates the power-supply voltage type (1: 100V / 2: Single-phase 200V).

② indicates the power-supply voltage type (1: 100V / 2: Single-phase 200V / 3: Three-phase 200V).

③ indicates the encoder type (I: Incremental / A: Absolute).

④ indicates the XSEL type (J / K / P / Q / R / S).

⑤ indicates field network specification symbol.

Slider Type

Mini

Standard

Controllers Integrated

Rod Type

Mini

Standard

Controllers Integrated

Table/ Arm/ Flat Type

Mini

Standard

Gripper/ Rotary Type

Linear Servo Type

Clean-room Type

Splash-Proof Type

Pulse Motor

Servo Motor (24V)

Servo Motor (200V)

Linear Servo Motor