

- Slider Type
- Mini
- Standard
- Controllers Integrated
- Rod Type
- Mini
- Standard
- Controllers Integrated
- Table/Arm /Flat Type
- Mini
- Standard
- Gripper/ Rotary Type
- Linear Servo Type
- Cleanroom Type
- Splash-Proof
- Controllers
- PMEC /AMEC**
- PSEP /ASEP
- ROBO NET
- ERC2
- PCON
- ACON
- SOON
- PSEL
- ASEL
- SSEL
- XSEL
- Pulse Motor
- Servo Motor (24V)**
- Servo Motor (200V)
- Linear Servo Motor

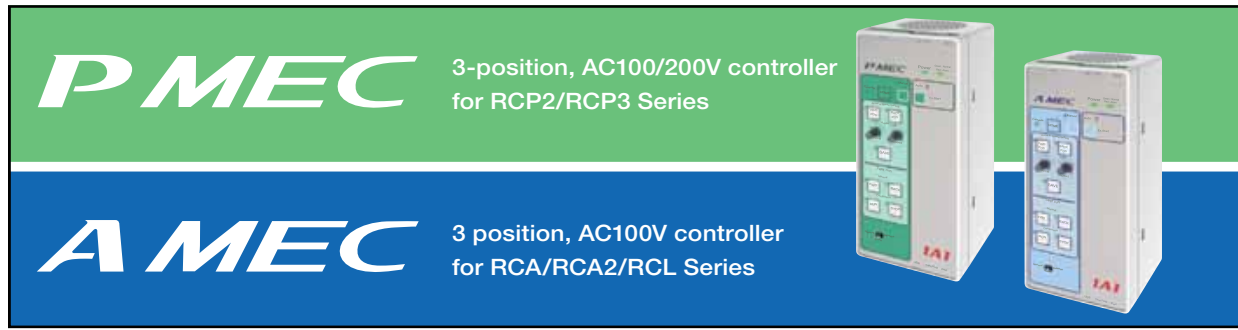

ROBO Cylinder 3-position controller **MEC** (Mechanical Engineer Control)

Feature

1 Low Cost

The PMEC package, which comes with a controller, power supply, acceleration/speed change function and PC connection cable, among others, is at an affordable price. The MEC PC software can be downloaded free of charge from IAI's website.

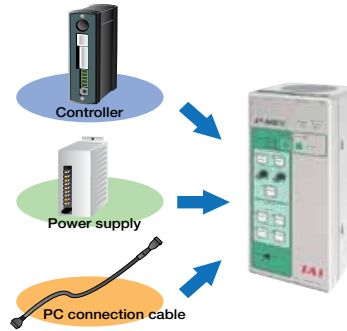

2 Easy Operation

Even a beginner can set up the controller without reading the operation manual. The acceleration and speed can be changed using the knobs on the controller.

* Setting range for acceleration/speed varies depending on the actuator. Please refer to the instruction manual for further detail.

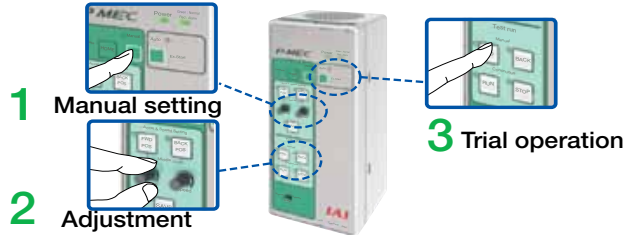

3 Easy Replacement from your Air-cylinder System

Operation signals are exactly the same as those used to operate air cylinders. This means that you can use the program of your current PLC directly.

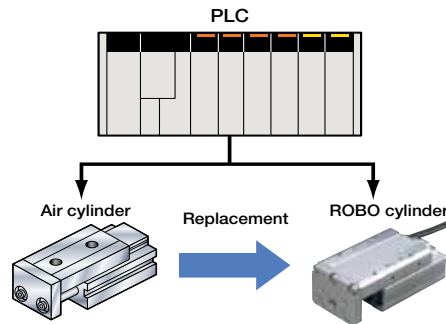

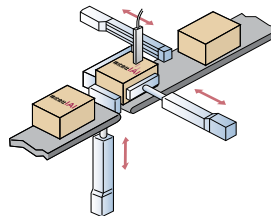

4 Push-motion Operation/Intermediate Stopping

Push-motion operation can be performed in the same manner as you would with any air-cylinder system. Also, you can cause the actuator to stop at any desired intermediate point between the home position and stroke end by changing the setting of the intermediate point using the MEC PC software.



477 PMEC / AMEC

Model List

Series	PMEC	AMEC
External View		
Applicable actuators	RCP2 / RCP3	
Power supply voltage	100V	100-240V
Price	-	-
Accessories	AC power supply cable (2m) USB cable (3m) I/O cable (2m) I/O connector EMG connector Standard mounting bracket	

Model

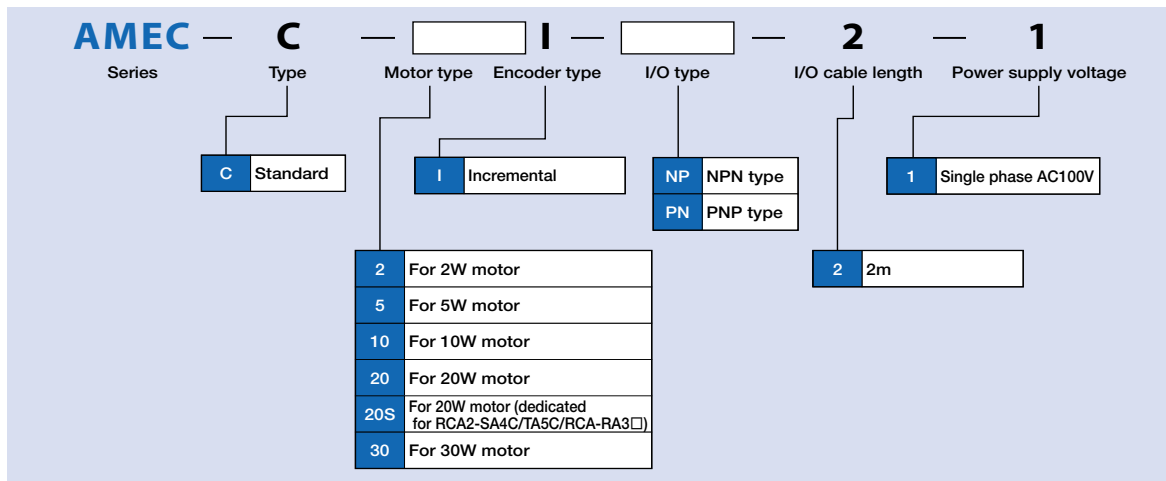
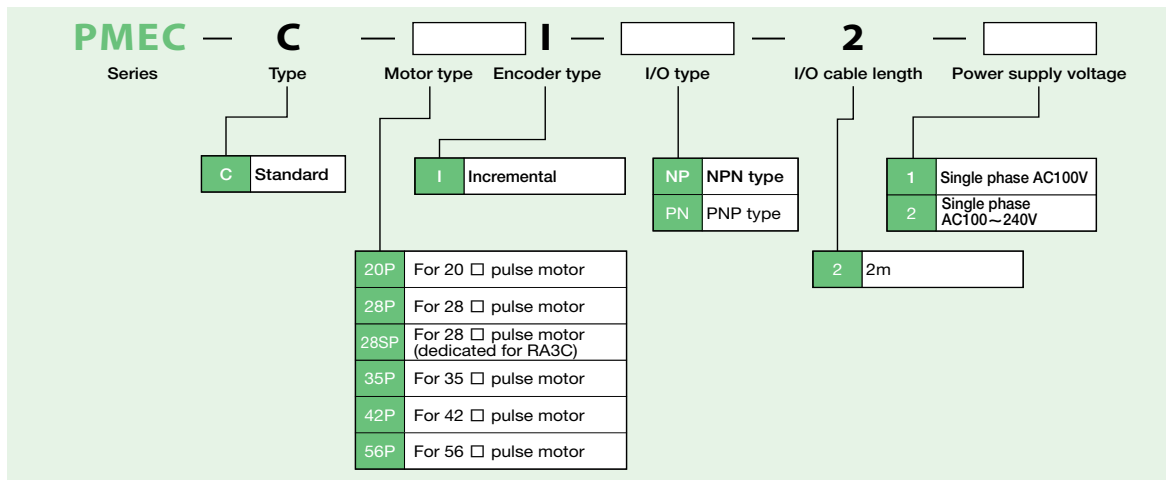

- Slider Type
- Mini
- Standard
- Controllers Integrated
- Rod Type
- Mini
- Standard
- Controllers Integrated
- Table/Arm /Flat Type
- Mini
- Standard
- Gripper/ Rotary Type
- Linear Servo Type
- Cleanroom Type
- Splash-Proof
- Controllers
- PMEC /AMEC
- PSEP /ASEP
- ROBO NET
- ERC2
- PCON
- ACON
- SCON
- PSEL
- ASEL
- SSEL
- XSEL
- Pulse Motor
- Servo Motor (24V)
- Servo Motor (200V)
- Linear Servo Motor

System Configuration

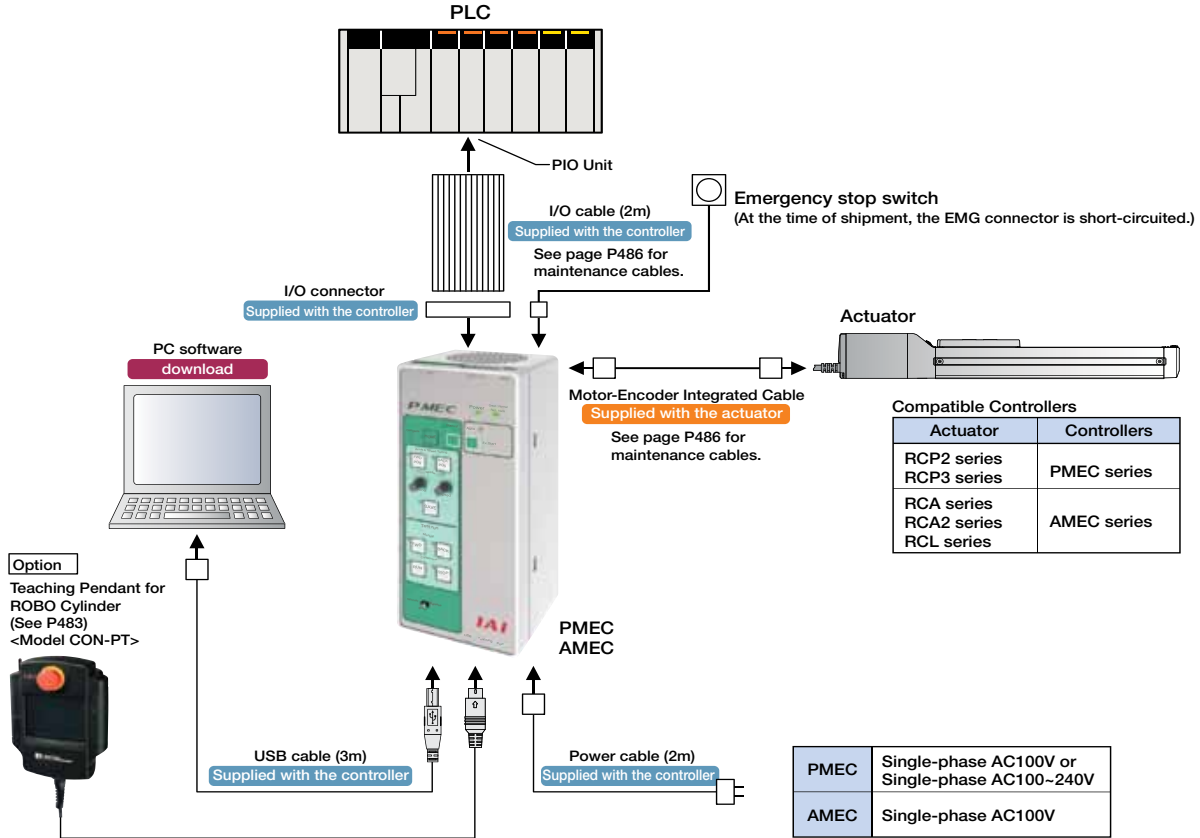

I/O Signal Table

Motion Pattern			2-Position Travel	3-Position Travel
Pin No.	Wire Color	Signal Type	Signal Name	Signal Name
1	Brown	PIO power	24V	24V
2	Red		0V	0V
3	Orange	Input	ST0 (Solenoid A: ON moves to end position, OFF moves to home position)	ST0 (Solenoid A: Move signal 1)
4	Yellow		—	ST1 (Solenoid B: Move signal 2)
5	Green		RES (Alarm reset)	RES (Alarm reset)
6	Blue		—	—
7	Purple	Output	LS0 (home position detection)/PE0 (home positioning complete)*1	LS0 (home position detection)/PE0 (home positioning complete)*1
8	Gray		LS1 (end position detection)/PE1 (end positioning complete)*1	LS1 (end position detection)/PE1 (end positioning complete)*1
9	White		HEND (Homing complete)	LS2 (intermediate point detection)/PE2 (intermediate positioning complete)*1
10	Black		* ALM (alarm)*2	* ALM (alarm)*2

*1: Signals PE0 through PE2 will be output if the pushing motion was enabled in the initial setting. Otherwise, LS0 through LS2 will be output.
 *2: * ALM is ON when normal, and OFF when it is activated.

MEC PC software

By using the MEC PC software you can change the stop position data or run a test operation. In addition, you can change the setting on the intermediate stop function, pushing function or change the coordinates.

The MEC PC software can be downloaded from the IAI website.

IAI Website: www.intelligentactuator.com

479 PMEC / AMEC

Explanation of PIO Patterns

PIO Pattern (2-position travel)

This motion pattern is between two positions, the home position and the end position. The home and end position can be configured numerically (using the MEC PC software or the optional touch panel teaching pendant). Two motions are possible: A positioning motion moves the rod or the slider to the specified position, and a pushing motion presses the rod against a workpiece.

Positioning

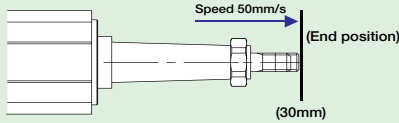

Input Signal

ST0	Solenoid A	ON
-----	------------	----

When ST0 is turned ON, the slider/rod moves at 50mm/s to the end position (30mm position).

End Position Data

Position	30mm
Speed	50mm/s
Pushing Force	—
Width	—

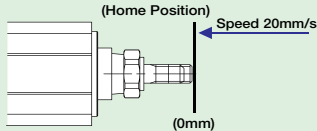

Input Signal

ST0	Solenoid A	OFF
-----	------------	-----

When ST0 is turned OFF, the slider/rod returns to the home position (0mm position) at 20mm/s.

Home Position Data

Position	0mm
Speed	20mm/s
Pushing Force	—
Width	—

PIO Pattern (2-position travel)

This motion pattern is between two positions, the home position and the end position, which enables a pushing motion of the rod against a workpiece.

Push

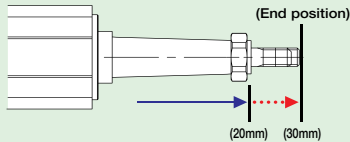

Input Signal

ST0	Solenoid A	ON
-----	------------	----

When the input 0 is turned ON, the actuator moves the rod to the 20mm position at 80mm/s, and from there, pushes it at slower speed to the 30mm position.

End Position Data

Position	30mm
Speed	80mm/s
Pushing Force	50%
Width	10mm

* The pushing motion is performed when there is a numerical value in the controller's push force data. (If there is no numerical value, a positioning motion is performed instead.)

PIO Pattern (3-position travel)

This motion pattern enables moves between three positions: the end position and the home position, as well as an intermediate position.

The positions are switched by combining two signals, ST0 and ST1.

Positioning

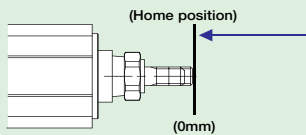

Input Signal

ST0	Solenoid A	ON
ST1	Solenoid B	OFF

When only the ST0 is turned ON, the actuator moves to the starting position at a set acceleration and speed.

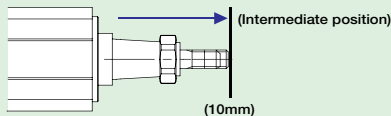

Input Signal

ST0	Solenoid A	ON*
ST1	Solenoid B	ON*

When both ST0 and ST1 are turned ON, it will move to the intermediate position at the set acceleration and speed. When both are turned OFF, it stops at the current position.

* By default, you can configure the MEC where you turn both signals OFF to move to the intermediate position, or both ON to stop at the current position.

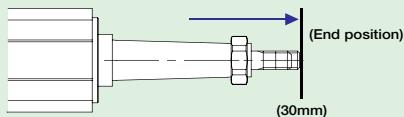

Input Signal

ST0	Solenoid A	OFF
ST1	Solenoid B	ON

When only ST1 is turned ON, the actuator moves to the end position at a set acceleration and speed.

- Slider Type
- Mini
- Standard
- Controllers Integrated
- Rod Type
- Mini
- Standard
- Controllers Integrated
- Table/Arm /Flat Type
- Mini
- Standard
- Gripper/ Rotary Type
- Linear Servo Type
- Cleanroom Type
- Splash-Proof
- Controllers
- PMEC /AMEC
- PSEP /ASEP
- ROBO NET
- ERC2
- PCON
- ACON
- SCON
- PSEL
- ASEL
- SSEL
- XSEL
- Pulse Motor
- Servo Motor (24V)
- Servo Motor (200V)
- Linear Servo Motor

- Slider Type
- Mini
- Standard
- Controllers Integrated
- Rod Type
- Mini
- Standard
- Controllers Integrated
- Table/Arm /Flat Type
- Mini
- Standard
- Gripper/ Rotary Type
- Linear Servo Type
- Cleanroom Type
- Splash-Proof
- Controllers
- PMEC /AMEC
- PSEP /ASEP
- ROBO NET
- ERC2
- PCON
- ACON
- SCON
- PSEL
- ASEL
- SSEL
- XSEL
- Pulse Motor
- Servo Motor (24V)
- Servo Motor (200V)
- Linear Servo Motor

Specifications Table

Item	Type		
Controller Type	PMEC		AMEC
Connectible Actuators	RCP2/RCP3 Series Actuators		RCA/RCA2/RCL Series Actuators
Number of Controllable Axes	Single axis		
Operation Method	Positioner Type		
Number of Positions	2 positions / 3 positions		
Backup Memory	EEPROM		
I/O Connector	10-pin terminal block		
I/O Points	4 input points / 4 output points		
Power for I/O	Externally supplied DC24V±10%		
Serial Communication	RS485: 1ch/USB: 1ch		
Position Detection Method	Incremental encoder		
Power Supply Voltage	AC100V-115V±10%	AC90V-264V	AC100V-115V±10%
Rated Current	1.3A	0.67A (AC100V)/0.36A (AC200V)	2.4A
Rush Current	30A	15A (AC100V)/30A (AC200V)	15A
Leak Current	0.50mA max	0.40mA max (AC100V) 0.75mA max (AC200V)	0.50mA max
Dielectric Strength Voltage	DC500V 1MΩ		
Vibration Resistance	XYZ directions 10-57Hz One-side amplitude 0.035mm (continuous), 0.075mm (intermittent) 57-150Hz 4.9m/s ² (continuous), 9.8m/s ² (intermittent)		
Ambient Operating Temperature	0-40°C		
Ambient Operating Humidity	10-85% RH (non-condensing)		
Ambient Operating Atmosphere	Free from corrosive gases		
Protection Class	IP20		
Weight	500g	508g	614g

Note: The minimum/maximum speeds vary depending on the actuator model. For more information, see the instruction manual, or contact IAI.

Outer Dimensions

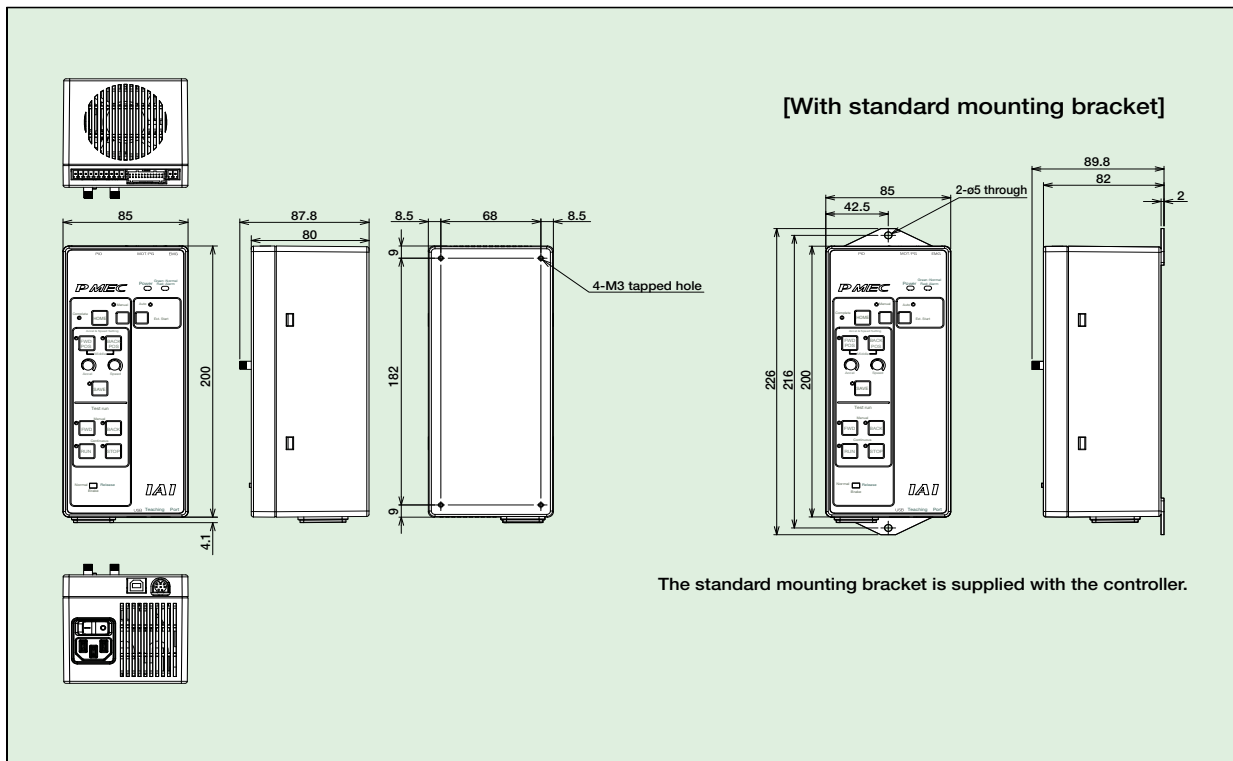

481 PMEC / AMEC

Names of Parts and Functions

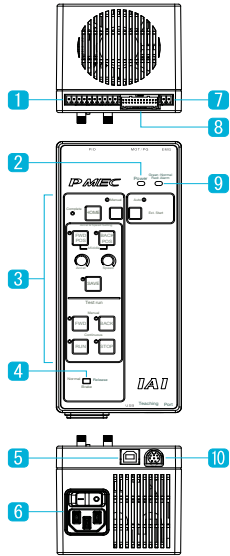

- 1 PIO connector Connects with a PLC or other external controllers to communicate inputs and outputs (I/O).
- 2 Power LED When the power is ON, it illuminates in green.
- 3 Control panel See below
- 4 Brake switch

Release	Used to release the brake of the actuator
Normal	The controller automatically controls the brake of the actuator
- 5 USB connector When using MEC PC software, connect to the computer via USB.
- 6 AC inlet Insert the power supply cable.
- 7 EMG connector Connect the emergency stop button. Short-circuit it if you will not be using an emergency stop button.
- 8 M/PG connector Insert the motor / encoder cable that connects with the actuator.
- 9 Status LED

RUN (Green)	Indicates the servo status. On = Servo ON, Off=Servo OFF (Energy-saving) status Flashing (1Hz)=Auto servo OFF
ALM (Red)	The LED illuminates if an alarm is turned ON or if the controller has come to an emergency stop.
EMG (Red)	
- 10 SIO Connector Connects with the teaching pendant (CON-PT, SEP-PT).

Explanation of the Control Panel

HOME button

When starting, homing is performed first to confirm the 0mm coordinate.

Manual button

Press this button to set the acceleration and/or speed, or to run a test operation. (Press for at least 1 second)

AUTO button

Press this button when operating from the MEC PC software or the PLC commands. (Press for at least 1 second)

Acceleration/Speed Settings
Configure the actuator's motion.

FWD POS / BACK POS button

Switch the motion you want to configure (see types below).

FWD POS: Motion toward the end position
BACK POS: Motion toward the home position
Middle: Motion toward an intermediate position
(Enabled from the MEC PC software. simultaneously press "FWD POS" and "BACK POS" to switch. During a 2-position stop, simultaneous pressing is disabled.)

Acceleration / Speed knob

By turning the knob, you can change the speed between 1%~100% of the actuator's maximum speed or rated acceleration / deceleration.
* The minimum speed may be less than 1% in some cases.

SAVE button

Saves the speed and acceleration adjusted above.

Test Operation
Confirm the saved motion by physically running the actuator.

FWD button

In a 2-position travel, the actuator moves from the BACK position to the FWD position. In a 3-position travel, the actuator moves from the BACK position to the intermediate position, then to the FWD position.

BACK button

The actuator returns to the starting position.

RUN button

In a 2-position travel, the actuator moves back and forth between the FWD and BACK positions. In a 3-position travel, the actuator repeats its movement from the BACK position, intermediate position, FWD position, then BACK position.

STOP button

Stops the above operation.

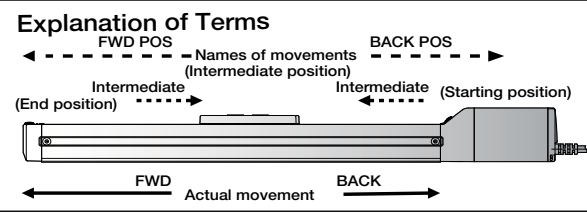

- Slider Type
- Mini
- Standard
- Controllers Integrated
- Rod Type
- Mini
- Standard
- Controllers Integrated
- Table/Arm /Flat Type
- Mini
- Standard
- Gripper/ Rotary Type
- Linear Servo Type
- Cleanroom Type
- Splash-Proof
- Controllers
- PMEC /AMEC
- PSEP /ASEP
- ROBO NET
- ERC2
- PCON
- ACON
- SCON
- PSEL
- ASEL
- SSEL
- XSEL
- Pulse Motor
- Servo Motor (24V)
- Servo Motor (200V)
- Linear Servo Motor

- Slider Type
- Mini
- Standard
- Controllers Integrated
- Rod Type
- Mini
- Standard
- Controllers Integrated
- Table/Arm /Flat Type
- Mini
- Standard
- Gripper/ Rotary Type
- Linear Servo Type
- Cleanroom Type
- Splash-Proof
- Controllers
- PMEC /AMEC
- PSEP /ASEP
- ROBO NET
- ERC2
- PCON
- ACON
- SCON
- PSEL
- ASEL
- SSEL
- XSEL
- Pulse Motor
- Servo Motor (24V)
- Servo Motor (200V)
- Linear Servo Motor

Option

● **Teaching pendant for position controller**

Features Data input device easy-to-operate even for beginners with a simple interactive menu screen. Operation arrangements such as positioning of home, end or intermediate position, setting of speed or push force and movement to jog/inching/order position are available.

■ **Model/specifications**

Item	Description	
Model	Japanese edition	CON-PT-M
	English edition	CON-PT-M-ENG
Type	Standard	
Function	Input/edit position data Movement functions (move to a specified position, jog, inch) Test input and output signals Edit parameters Switch language (Japanese/English)	
Label	3-color LED with backlight	
Ambient operating temp./humidity	0 ~ 50°C 20 ~ 85%RH (no condensation)	
Environmental resistance	IP40	
Weight (including cable)	750g	
Accessories	Touch pen	
Standard price	-	



■ **Part names / dimensions**

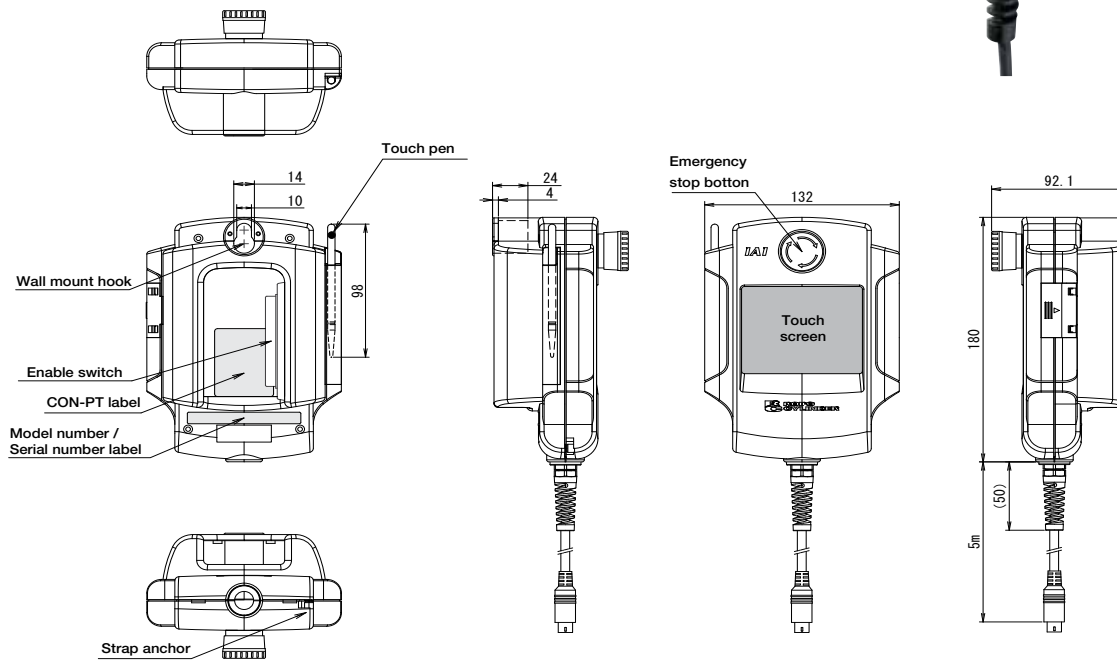

■ **Option**

- Strap model STR-1



483 PME / AMEC

● **DIN Rail Mounting Bracket MEC-AT-D**

■ **Dimensions**

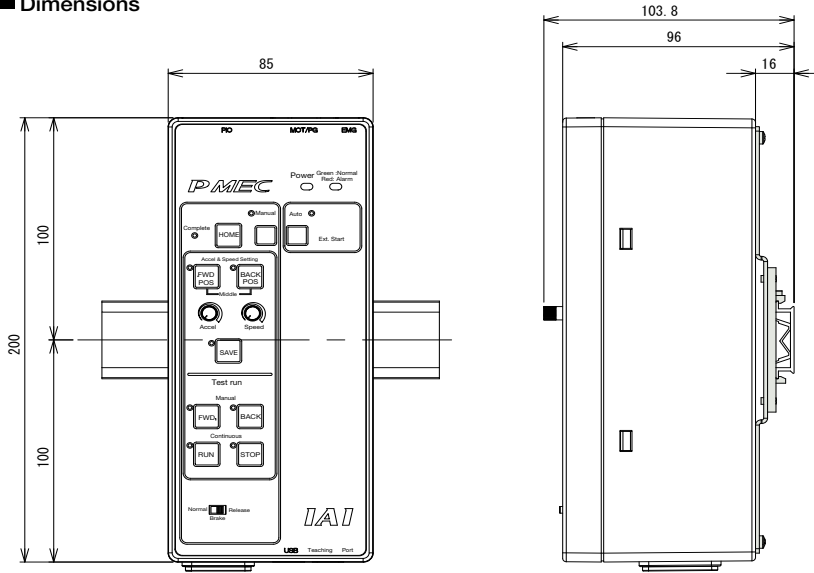

● **Maintenance cable**

■ **List of maintenance cable models**

Type		Cable length	Model	Standard price
Integrated motor-encoder cable	PMEC ↔ RCP3 RCP2-GRSS/GRLS/ GRST/ SRA4R/SRGS4R/ SRGD4R	1m	CB-APSEP-MPA010	-
		3m	CB-APSEP-MPA030	-
		5m	CB-APSEP-MPA050	-
	PMEC ↔ RCP2	1m	CB-PSEP-MPA010	-
		3m	CB-PSEP-MPA030	-
		5m	CB-PSEP-MPA050	-
	PMEC ↔ RCP2-RTBS/RTBSL -RTCS/RTCSL	1m	CB-RPSEP-MPA010	-
		3m	CB-RPSEP-MPA030	-
		5m	CB-RPSEP-MPA050	-
	AMEC ↔ RCA	1m	CB-ASEP-MPA010	-
		3m	CB-ASEP-MPA030	-
		5m	CB-ASEP-MPA050	-
I/O cable	2m	CB-APMEC-PIO020-NC	-	
	3m	CB-APMEC-PIO030-NC	-	
	5m	CB-APMEC-PIO050-NC	-	
USB cable	3m	CB-SEL-USB030	-	

- Slider Type
- Mini
- Standard
- Controllers Integrated
- Rod Type
- Mini
- Standard
- Controllers Integrated
- Table/Arm /Flat Type
- Mini
- Standard
- Gripper/ Rotary Type
- Linear Servo Type
- Cleanroom Type
- Splash-Proof
- Controllers
- PMEC /AMEC
- PSEP /ASEP
- ROBO NET
- ERC2
- PCON
- ACON
- SCON
- PSEL
- ASEL
- SSEL
- XSEL
- Pulse Motor
- Servo Motor (24V)
- Servo Motor (200V)
- Linear Servo Motor

Components for maintenance

Please refer to the models mentioned below when arrangements such as cable replacement are needed after purchasing the product.

[RCP3/RCP2 (for specific models*) /RCA2/RCL]-[PMEC/AMEC] Motor encoder integrated cable for indirect connection

Model **CB-APSEP-MPA**

*Enter cable length (L) required in (compatible for up to max. 20m).
Example: 080=8m

* For RCP2-GRSS/GRLS/GRST/SRA4R/SRGS4R/SRGD4R

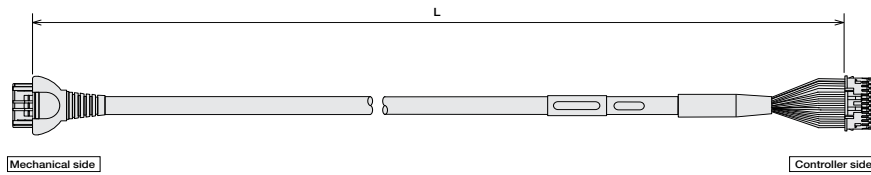

Mechanical side Pin number		Controller side Pin number
A1	Black [0A] (U)	1
B1	White [VMM] (V)	2
A2	Brown [0/A] (W)	5
B2	Green [0B] (-)	3
A3	Yellow [VMM] (-)	4
B3	Red [0/B] (-)	6
A4	Orange [LS+](BK+)	7
B4	Gray [LS-](BK-)	8
A6	White [-] (A+)	11
B6	Yellow [-] (A-)	12
A7	Red [A+] (B+)	13
B7	Green [A-] (B-)	14
A8	Black [B+] (Z+)	15
B8	Brown [B-] (Z-)	16
A5	Black (label) [BK+] (LS+)	9
B5	Brown (label) [BK-] (LS-)	10
A9	Green (label) [GNDLS] (GNDLS)	20
B9	Red (label) [VPS] (VPS)	18
A10	White (label) [VCC] (VCC)	17
B10	Yellow (label) [GND] (GND)	19
A11	NC	21
B11	Shield [FG] (FG)	24
	NC	22
	NC	23

Min. bend radius r=68mm or larger (when movable unit is used)

[RCP2]-[PMEC] Integrated motor-encoder connection cable

Model **CB-PSEP-MPA**

*Enter cable length (L) required in (compatible for up to max. 20m).
Example: 080=8m

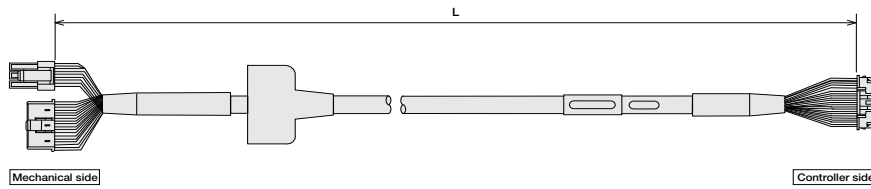

Mechanical side Pin number		Controller side Pin number
1	Black [0A]	1
2	White [VMM]	2
4	Red [0B]	3
5	Green [VMM]	4
3	Brown [0/A]	5
6	Yellow [0/B]	6
16	Orange [BK+]	9
17	Gray [BK-]	10
5	NC	11
6	NC	12
13	Black [LS+]	7
14	Brown [LS-]	8
1	White [A+]	13
2	Yellow [A-]	14
3	Red [B+]	15
4	Green [B-]	16
10	White (label) [VCC]	17
11	Yellow (label) [VPS]	18
9	Red (label) [GND]	19
12	Green (label) [Spare]	20
15	NC	21
7	NC	22
8	NC	23
18	Shield [FG]	24

Min. bend radius r=68mm or larger (when movable unit is used)

[RCA]-[AMEC] Integrated motor-encoder connection cable

Model **CB-ASEP-MPA**

*Enter cable length (L) required in (compatible for up to max. 20m).
Example: 080=8m

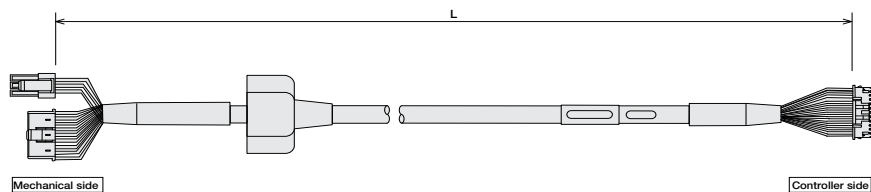

Mechanical side Pin number		Controller side Pin number
1	Red [U]	1
2	Yellow [V]	2
	NC	3
	NC	4
3	Black [W]	5
	NC	6
18	Orange [BK+]	7
17	Gray [BK-]	8
7	Black [LS+]	9
16	Brown [LS-]	10
1	White [A+]	11
2	Yellow [A-]	12
3	Red [B+]	13
4	Green [B-]	14
10	Black (label) [Z+]	15
11	Brown (label) [Z-]	16
14	White (label) [VCC]	17
13	Yellow (label) [VPS]	18
15	Red (label) [GND]	19
6	Green (label) [Spare]	20
5	NC	21
8	NC	22
12	NC	23
9	Shield [FG]	24

Min. bend radius r=68mm or larger (when movable unit is used)

485

PMEC / AMEC

[RCP2 small rotary]-[PMEC] Motor encoder integrated cable for indirect connection

Model **CB-RPSEP-MPA**

*Enter cable length (L) required in (compatible for up to max. 20m).
Example: 080=8m

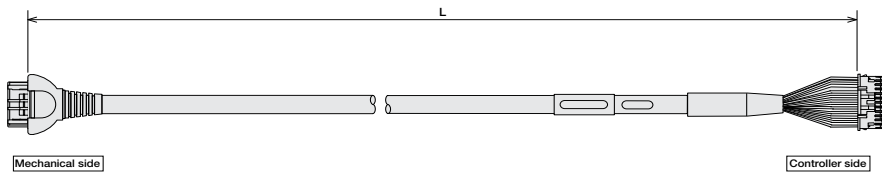

Mechanical side Pin number		Controller side Pin number
A1	Black [ØA]	1
B1	White [VMM]	2
A2	Brown [Ø/A]	5
B2	Green [ØB]	3
A3	Yellow [VMM]	4
B3	Red [Ø/B]	6
A6	Orange [LS+]	7
B6	Gray [LS-]	8
A7	Red [A+]	13
B7	Green [A-]	14
A8	Black [B+]	15
B8	Brown [B-]	16
A4	NC	7
B4	NC	8
A5	Black (label)[BK+]	9
B5	Brown (label)[BK-]	10
A9	Green (label)[GNDLS]	20
B9	Red (label)[VPS]	18
A10	White (label)[VCC]	19
B10	Yellow (label)[GND]	17
A11	NC	21
B11	Shield FG	24
	NC	22
	NC	23

Min. bend radius r=68mm or larger (when movable unit is used)

I/O cable for PMEC-C/AMEC-C

Model **CB-APMEC-PIO** -NC

*The 3 types differ in cable length: 020=2m, 030=3m, 050=5m

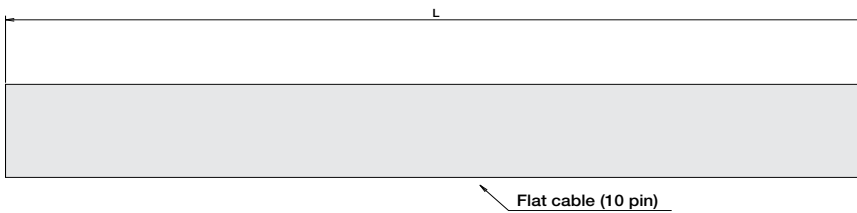

Flat cable (10 pin)

Pin NO.	Electric wire color	Signal
1	Brown	PIO Power supply
2	Red	
3	Orange	Input
4	Yellow	
5	Green	
6	Blue	
7	Purple	Output
8	Grey	
9	White	
10	Black	

- Slider Type
- Mini
- Standard
- Controllers Integrated
- Rod Type
- Mini
- Standard
- Controllers Integrated
- Table/Arm /Flat Type
- Mini
- Standard
- Gripper/ Rotary Type
- Linear Servo Type
- Cleanroom Type
- Splash-Proof
- Controllers
- PMEC /AMEC
- PSEP /ASEP
- ROBO NET
- ERC2
- PCON
- ACON
- SCON
- PSEL
- ASEL
- SSEL
- XSEL
- Pulse Motor
- Servo Motor (24V)
- Servo Motor (200V)
- Linear Servo Motor