

Position Controller for ROBO Cylinder
SEP series 8-axis Type

MSEP



8 AXES in ONE

8 MSEP controller AXES in ONE

Achieving High-Performance in a Compact Design Network Connectable Controller

Features

1

Compact Design

A successfully designed 8-axis compact controller with a 123 mm width x 115 mm height unit.

A 60% reduction in width from the predecessor controller which contributes to space savings within the controller cabinet.

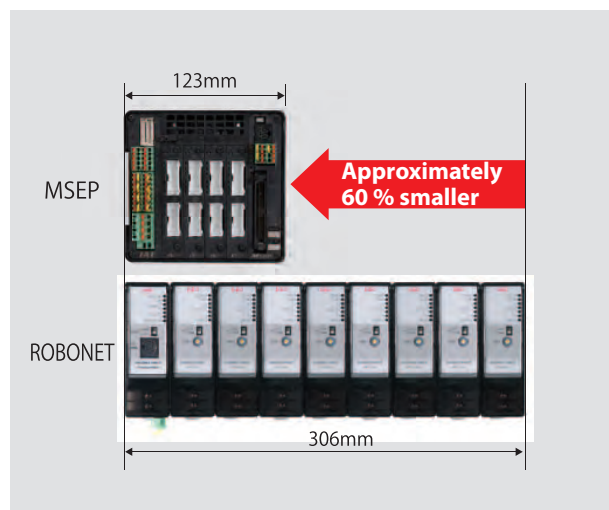

2

Supports major field networks

Allows direct connection with the major field networks including DeviceNet, CC-Link, PROFIBUS-DP, MECHATROLINK, CompoNet, EtherCAT, and EtherNet/IP.

Network Specification Features

- 256 positioning points per each axis
- Allows designation of position and speed navigation numerically
- Ability to verify current position in real-time
- Significant communication time reduction within the controller (Approximately by 1/10 compared to the predecessor model)



1

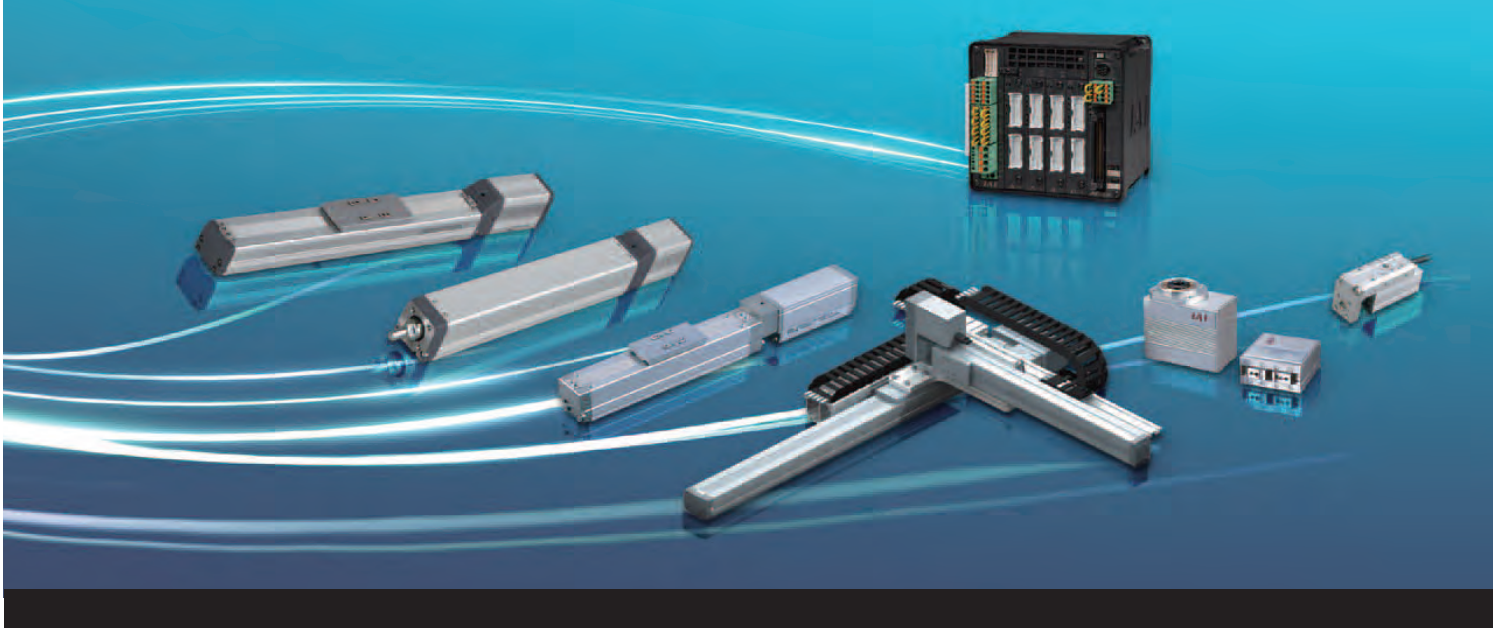

3 Supports both the pulse motor and the servo motor

A single MSEP controller can operate both the pulse motor and the servo motor type actuators, reducing set-up efforts significantly such as wiring even when different types of actuators have to be used at the same time.

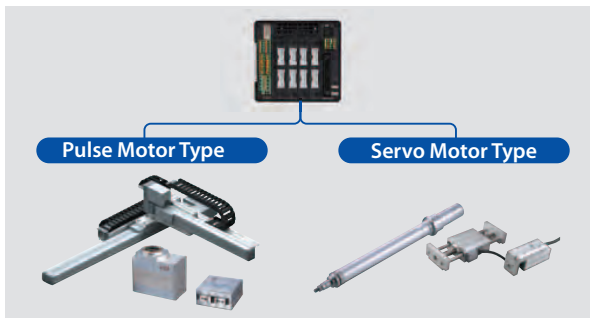

4 Simple absolute option

An absolute position encoder is available, which saves the position data by battery, providing prompt operation without returning to the home position after power off. Even in an emergency shut-off or momentary power-loss, it allows continuous operation from its last position.

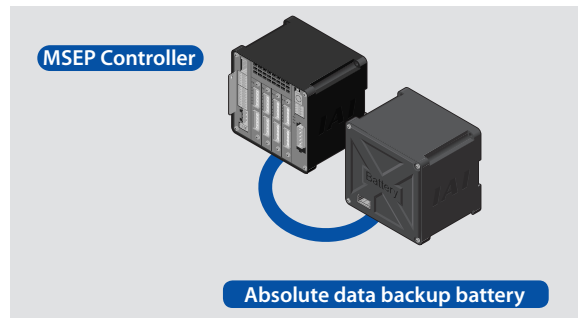

5 Checking when to maintain based on the total number of movements and total distance travelled

The total number of actuator movements and the total distance travelled are calculated and recorded in the controller, and when the predetermined count or distance is exceeded, a signal is output to an external device. You can use this function to check when the actuator needs re-greasing or periodic inspection.



6 Recording the alarm occurrence time with the calendar function

An additional clock function facilitates the alarm analysis from the convenience of the display screen that shows the time of the alarm occurrence. (The retention period of the date and time data is 10 days)

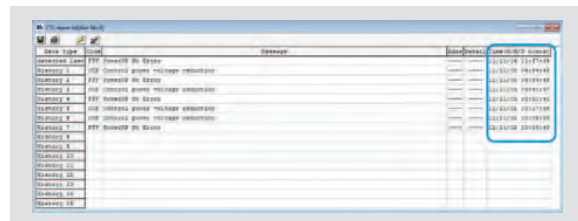

Guide for the description of the selected configuration

The description of the MSEP controller configuration varies depending on the type of actuator connected to the controller, and the total number of axes installed. Please see the following conditions to configure a desired controller.

Connect the **SAME TYPE** of actuators (either pulse motor type or servo motor type)

Connect a **MIXTURE OF TYPES** of actuators (both pulse motor type and servo motor type)

Please indicate the motor type code of the actuator starting from the 1st axis respectively.

e.g.) MSEP — C — 4 — 42PI — 56PI — 42P — 56PI — NP — 2 — 0

Total number of axes: 4
 1st axis: Pulse motor
 2nd axis: Pulse motor
 3rd axis: Pulse motor
 4th axis: Pulse motor

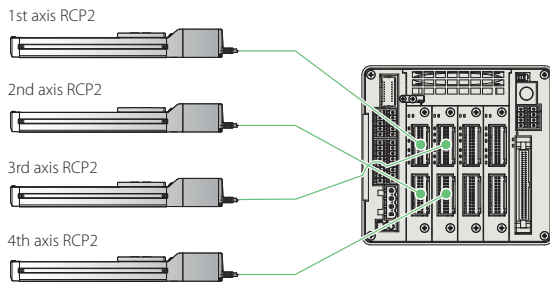

If the total number of axes is an odd count, please indicate an [N] following the last axis description (as shown after the 3rd axis below for example).

e.g.) MSEP — C — 3 — 42PI — 56PI — 42P — N — NP — 2 — 0

Total number of axes: 3
 1st axis: Pulse motor
 2nd axis: Pulse motor
 3rd axis: No connected axis

Each board is designed to connect to a pair of axes, and two different types of motors cannot be connected to the same board. Please indicate the same types of motors for each pair of axes.

e.g.) MSEP — C — 4 — 42PI — 56PI — 20I — 20I — NP — 2 — 0

Total number of axes: 4
 1st axis: Pulse motor
 2nd axis: Pulse motor
 3rd axis: Servo motor
 4th axis: Servo motor

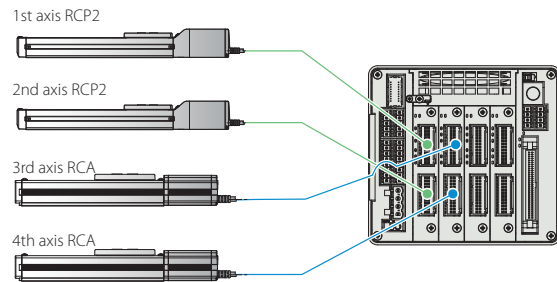

If either motor type is an odd count, please indicate an [N] following the last axis description per the corresponding board.

e.g.) MSEP — C — 3 — 42PI — N — 20SI — 30I — NP — 2 — 0

Total number of axes: 3
 1st axis: Pulse motor
 2nd axis: No connected axis
 3rd axis: Servo motor

<If you choose to operate the controller with fewer axes connections now but may add more in the future>

- If there's a possibility to increase connections, for example, to 6 or 8 axes in the future but would like to start with only 4 axes to operate the controller now, it is possible to keep the base board installed as is and leave room for the potential axes by indicating an [UNUSED AXIS].
- When configuring unused axis/axes for the pulse motor, please indicate a [P] in the box for the motor type.
- When configuring unused axis/axes for the servo motor, please indicate an [A] in the box for the motor type.
- When configuring unused axis/axes, please include number of unused axis/axes in the total number of axes.

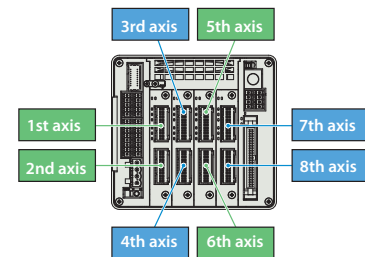

e.g.) MSEP — C — 8 — 42PI — 56PI — 20I — 10I — PI — PI — AI — AI — NP — 2 — 0

Total number of axes: 8
 1st axis: Pulse motor
 2nd axis: Pulse motor
 3rd axis: Servo motor
 4th axis: Servo motor
 5th axis: Unused axis (Pulse motor)
 6th axis: Unused axis (Pulse motor)
 7th axis: Unused axis (Servo motor)
 8th axis: Unused axis (Servo motor)

Actuator combination patterns for the MSEP

There are 40 combination patterns of the pulse motor type or the servo motor type actuator that can be connected to the MSEP controller as shown in the table below.

(all * are an incremental specification)

(The boxes in the configuration lines are to indicate the type of motor code number)

<Connectable actuators>

Pulse Pulse motor type actuator <ul style="list-style-type: none"> • RCP4 series (*) • RCP3 series • RCP2 series 	Servo Servo motor type actuator <ul style="list-style-type: none"> • RCA2 series (*) • RCA series • RCL series
-------------------------------------------------------------------------------------------------------------------------------------------------------------	-----------------------------------------------------------------------------------------------------------------------------------------------------------

(*) High-output motion is not available

1-axis to 5-axis specification

	Driver slot 0		Driver slot 1		Driver slot 2		Driver slot 3		Configuration	Pattern No	Unit price Incremental specification PIO specification
	AX0	AX1	AX2	AX3	AX4	AX5	AX6	AX7			
1-axis specification		Pulse	N						MSEP-C-1-□PI-N-(*)	1	-
		Servo	N						MSEP-C-1-□I-N-(*)	2	-
2-axis specification		Pulse	Pulse						MSEP-C-2-□PI-□PI-(*)	3	-
		Pulse	N	Servo	N				MSEP-C-2-□PI-N-□I-N-(*)	4	-
		Servo	Servo						MSEP-C-2-□I-□I-(*)	5	-
3-axis specification		Pulse	Pulse	Pulse	N				MSEP-C-3-□PI-□PI-□PI-N-(*)	6	-
		Pulse	Pulse	Servo	N				MSEP-C-3-□PI-□PI-□I-N-(*)	7	-
		Pulse	N	Servo	Servo				MSEP-C-3-□PI-N-□I-□I-(*)	8	-
		Servo	Servo	Servo	N				MSEP-C-3-□I-□I-□I-N-(*)	9	-
4-axis specification		Pulse	Pulse	Pulse	Pulse				MSEP-C-4-□PI-□PI-□PI-□PI-(*)	10	-
		Pulse	Pulse	Pulse	N	Servo	N		MSEP-C-4-□PI-□PI-□PI-N-□I-N-(*)	11	-
		Pulse	Pulse	Servo	Servo				MSEP-C-4-□PI-□PI-□I-□I-(*)	12	-
		Pulse	N	Servo	Servo	Servo	N		MSEP-C-4-□PI-N-□I-□I-□I-N-(*)	13	-
		Servo	Servo	Servo	Servo				MSEP-C-4-□I-□I-□I-□I-(*)	14	-
5-axis specification		Pulse	Pulse	Pulse	Pulse	Pulse	N		MSEP-C-5-□PI-□PI-□PI-□PI-□PI-N-(*)	15	-
		Pulse	Pulse	Pulse	Pulse	Servo	N		MSEP-C-5-□PI-□PI-□PI-□PI-□I-N-(*)	16	-
		Pulse	Pulse	Pulse	N	Servo	Servo		MSEP-C-5-□PI-□PI-□PI-N-□I-□I-(*)	17	-
		Pulse	Pulse	Servo	Servo	Servo	N		MSEP-C-5-□PI-□PI-□I-□I-□I-N-(*)	18	-
		Pulse	N	Servo	Servo	Servo	Servo		MSEP-C-5-□PI-N-□I-□I-□I-□I-(*)	19	-
		Servo	Servo	Servo	Servo	Servo	N		MSEP-C-5-□I-□I-□I-□I-□I-N-(*)	20	-

Standard price chart

The standard price of the MSEP controller can be calculated by adding the **2** I/O type price, plus additional prices for the **3** absolute position encoder specification, and the **4** absolute data backup battery (Absolute-battery) option to the basic unit prices as listed in **1** below.

<p>1 Basic unit price (Incremental specification + PIO specification)</p> <p>2 Additional price by I/O type</p> <p>3 Additional price for the absolute position encoder specification</p> <p>4 Additional battery price for the absolute position encoder specification</p>	<p>The prices of combination patterns from page 9 (all incremental axes)</p> <p>For field network specification, please add the price.</p> <p>For the absolute position encoder specification, please add the price for the total number of axes in the controller.</p> <p>Please add the battery price for the absolute position encoder specification. If the battery is not necessary such as it is an extra module to the controller, (if configuration code ABBN for absolute position encoder specification is selected), please omit the price for 4.</p>
---------------------------------------------------------------------------------------------------------------------------------------------------------------------------------------------------------------------------------------------------------------------------------------------------------	-------------------------------------------------------------------------------------------------------------------------------------------------------------------------------------------------------------------------------------------------------------------------------------------------------------------------------------------------------------------------------------------------------------------------------------------------------------------------------------------------------------------------------------------------------------------------

1		2	3	4	
Pattern No	Unit price (Incremental specification/ PIO specification)	Additional I/O type price	Additional absolute position encoder specification price	Additional battery price for the absolute position encoder specification	Standard price
1	-				
2	-				
3	-				
4	-				
5	-				
6	-				
7	-				
8	-				
9	-				
10	-				
11	-	DeviceNet specification	1st axis	1st axis	
12	-	-	-	-	
13	-	CC-Link specification	2nd axis	2nd axis	
14	-	-	-	-	
15	-	PROFIBUS-DP	3rd axis	3rd axis	
16	-	-	-	-	
17	-	CompoNet specification	4th axis	4th axis	
18	-	-	-	-	
19	-	MECHATROLINK specification	5th axis	5th axis	
20	-	-	-	-	
21	-	EtherCAT specification	6th axis	6th axis	
22	-	-	-	-	
23	-	EtherNet/IP specification	7th axis	7th axis	
24	-	-	-	-	
25	-		8th axis	8th axis	
26	-		-	-	
27	-				
28	-				
29	-				
30	-				
31	-				
32	-				
33	-				
34	-				
35	-				
36	-				
37	-				
38	-				
39	-				
40	-				

+ + + =

Specification specific standard price

System configuration

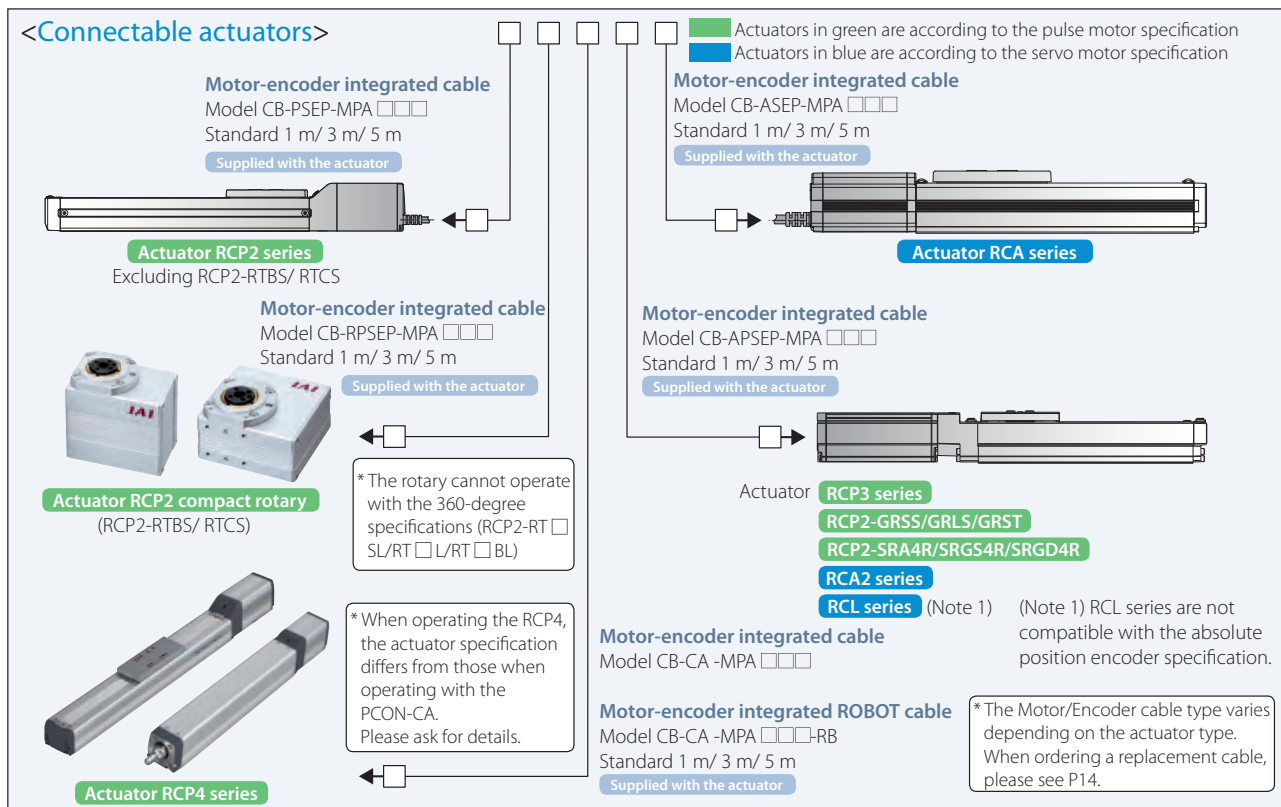
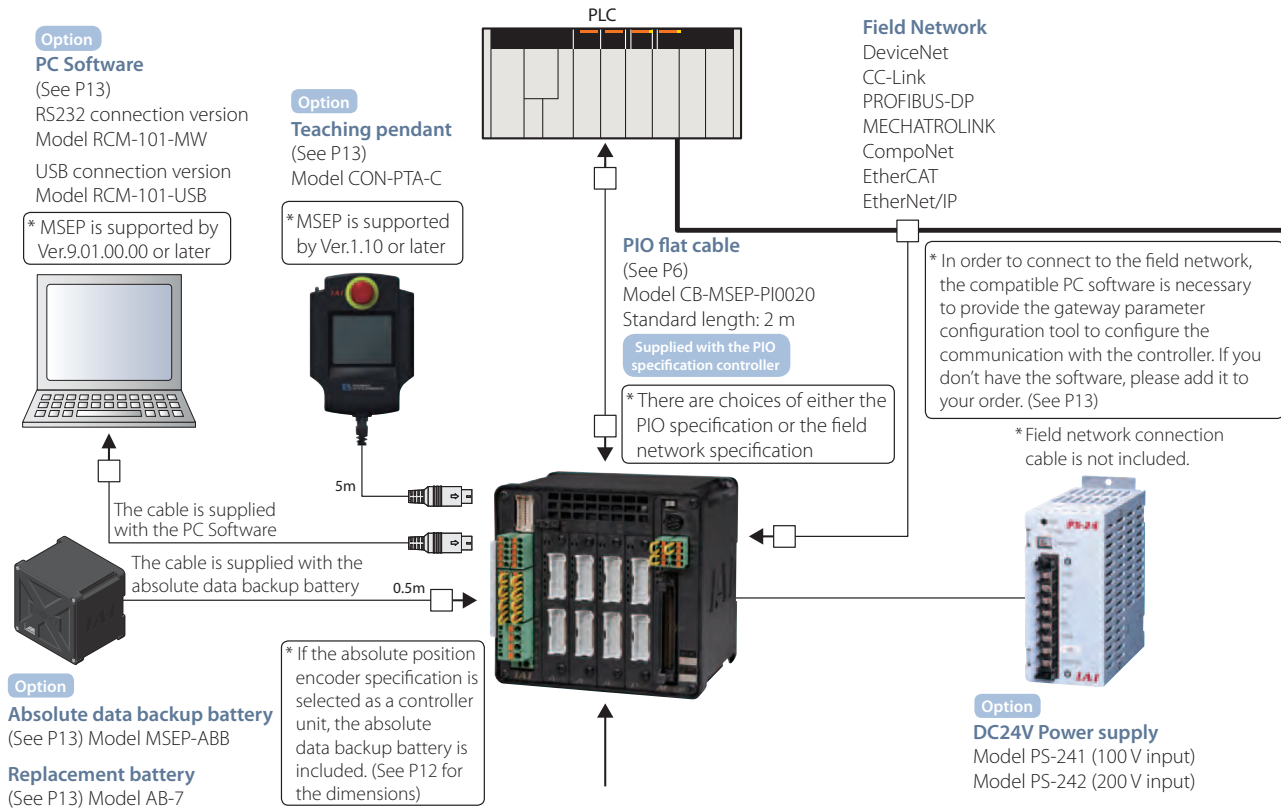

PIO Controlled Motion Mode

The MSEP controller with the PIO control specification offers the following six-motion modes. In addition, Mode No. 0 through 2 support both the single and double solenoid valves for signal configuration.

Motion Mode No.	0		1		2		3	4	5	
Motion Mode Type	Standard 2-position motion		Speed change during movement		Position data change		2-input/ 3-position motion	3-input/ 3-position motion	Continuous cycle operation	
Feature	2-position motion		2-position motion		2-position motion		3-position motion	3-position motion	2-position continuous motion	
	Push		Push		Push		Push	Push	Push	
Solenoid configurations	-		Speed change during movement		Travel position data change		-	-	-	
	Single	Double	Single	Double	Single	Double	-	-	-	
Input	0	Motion signal	Motion signal 1	Motion signal	Motion signal 1	Motion signal	Motion signal 1	Retract motion signal	Continuous motion signal	
	1	Pause signal	Motion signal 2	Pause signal	Motion signal 2	Pause signal	Motion signal 2	Extend motion signal	Pause signal	
	2	Reset signal		Speed change signal (Reset signal)		Target position change signal (Reset signal)		Reset signal	Intermediate point motion command signal (Reset signal)	Reset signal
	3	-/Servo-ON signal		-/Servo-ON signal		-/Servo-ON signal		-/Servo-ON signal	-/Servo-ON signal	-/Servo-ON signal
Output	0	Retract motion output signal		Retract motion output signal		Retract motion output signal		Retract motion output signal	Retract motion output signal	
	1	Extend motion output signal		Extend motion output signal		Extend motion output signal		Extend motion output signal	Extend motion output signal	
	2	Homing complete signal/ Servo-ON output signal		Homing complete signal/ Servo-ON output signal		Homing complete signal/ Servo-ON output signal		Intermediate point position output signal	Intermediate point position output signal	
	3	Alarm output signal/ Servo-ON output signal		Alarm output signal/ Servo-ON output signal		Alarm output signal/ Servo-ON output signal		Alarm output signal/ Servo-ON output signal	Alarm output signal/ Servo-ON output signal	

* Please refer to the controller operation instruction for the above signal information. (Download is available from our website)

PIO Plug Chart

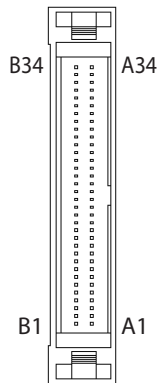

Connector name: HIF6-68PA-1.27DS(Hirose Electric)					
Pin No.	Category	Signal ID	Pin No.	Category	Signal ID
A1	24V	For I/O	A18	Output	OUT0
A2		IN0	A19	Output	OUT1
A3	Input (Axis No. 0)	IN1	A20	Output	OUT2
A4		IN2	A21	Output	OUT3
A5	Input (Axis No. 1)	IN3	A22	Output	OUT4
A6		IN4	A23	Output	OUT5
A7	Input (Axis No. 1)	IN5	A24	Output	OUT6
A8		IN6	A25	Output	OUT7
A9	Input (Axis No. 2)	IN7	A26	Output	OUT8
A10		IN8	A27	Output	OUT9
A11	Input (Axis No. 2)	IN9	A28	Output	OUT10
A12		IN10	A29	Output	OUT11
A13	Input (Axis No. 3)	IN11	A30	Output	OUT12
A14		IN12	A31	Output	OUT13
A15	Input (Axis No. 3)	IN13	A32	Output	OUT14
A16		IN14	A33	Output	OUT15
A17		IN15	A34	0V	For I/O

Connector name: HIF6-68PA-1.27DS(Hirose Electric)					
Pin No.	Category	Signal ID	Pin No.	Category	Signal ID
B1	24V	For I/O	B18	Output	OUT16
B2	Input (Axis No. 4)	IN16	B19	Output	OUT17
B3		IN17	B20	Output	OUT18
B4	Input (Axis No. 4)	IN18	B21	Output	OUT19
B5		IN19	B22	Output	OUT20
B6	Input (Axis No. 5)	IN20	B23	Output	OUT21
B7		IN21	B24	Output	OUT22
B8	Input (Axis No. 5)	IN22	B25	Output	OUT23
B9		IN23	B26	Output	OUT24
B10	Input (Axis No. 6)	IN24	B27	Output	OUT25
B11		IN25	B28	Output	OUT26
B12	Input (Axis No. 6)	IN26	B29	Output	OUT27
B13		IN27	B30	Output	OUT28
B14	Input (Axis No. 7)	IN28	B31	Output	OUT29
B15		IN29	B32	Output	OUT30
B16	Input (Axis No. 7)	IN30	B33	Output	OUT31
B17		IN31	B34	0V	For I/O

PIO Flat Cable

Mode **CB-MSEP-PIO**

* Please indicate cable length (L) in maximum 10 m. e.g.) 020=2 m

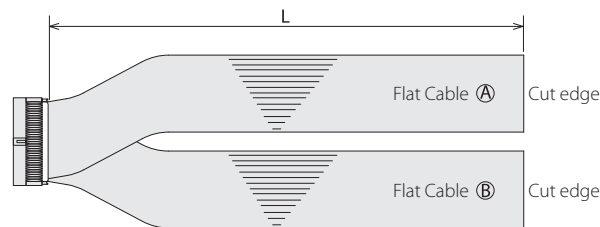

Connector: HIF6-068D-1.27R

Connection Chart

Pin No.	Signal name
A1	For I/O +24V
A2	IN0
A3	IN1
A4	IN2
A5	IN3
A6	IN4
A7	IN5
A8	IN6
A9	IN7
A10	IN8
A11	IN9
A12	IN10
A13	IN11
A14	IN12
A15	IN13
A16	IN14
A17	IN15
A18	OUT0
A19	OUT1
A20	OUT2
A21	OUT3
A22	OUT4
A23	OUT5
A24	OUT6
A25	OUT7
A26	OUT8
A27	OUT9
A28	OUT10
A29	OUT11
A30	OUT12
A31	OUT13
A32	OUT14
A33	OUT15
A34	GND for I/O

Connector: HIF6-068D-1.27R

Pin No.	Signal name
B1	For I/O +24V
B2	IN16
B3	IN17
B4	IN18
B5	IN19
B6	IN20
B7	IN21
B8	IN22
B9	IN23
B10	IN24
B11	IN25
B12	IN26
B13	IN27
B14	IN28
B15	IN29
B16	IN30
B17	IN31
B18	OUT16
B19	OUT17
B20	OUT18
B21	OUT19
B22	OUT20
B23	OUT21
B24	OUT22
B25	OUT23
B26	OUT24
B27	OUT25
B28	OUT26
B29	OUT27
B30	OUT28
B31	OUT29
B32	OUT30
B33	OUT31
B34	GND for I/O

PIO Input/Output Interface

Input External Input Specification

Item	Specification
Input voltage	DC24V ±10%
Input current	5mA, 1 circuit
ON/OFF voltage	ON voltage MIN.DC18V OFF voltage MAX.DC6V

NPN specification

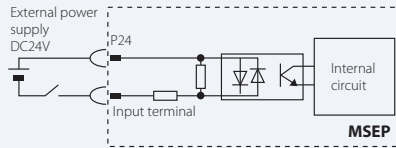

PNP specification

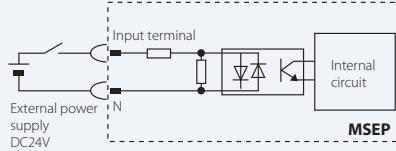

Output External Output Specification

Item	Specification
Load voltage	DC24V ±10%
Maximum load current	50mA, 1 circuit
Leakage current	MAX 2mA/one point

NPN specification

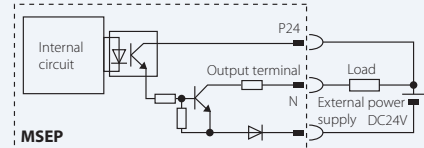

PNP specification

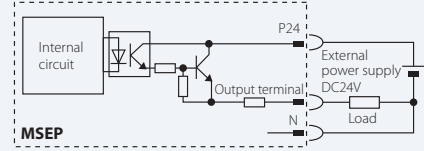

Field network control motion mode

There are five motion modes to choose from in the field network control mode with the MSEP controller as follows.

Motion pattern (*1)	Description	PLC	Outline
Positioner 1/ Simple numerical mode	Positioner 1 mode is programmable up to 256 positions of data to designate the stop position. The simple numerical control allows designating the target position numerically. They both have the capability of monitoring the current position.	Target position Target position number Control signal Current position End position number Status signal	
Direct numerical control mode	This mode allows designating the target position, velocity, acceleration, and current parameters for pushing. Also, it is capable of monitoring the current position, real-time velocity, and the electric current command value.	Target position, Positioning width, Velocity, Acceleration, Pushing percentage, Control signal Current position Current value (Designated value) Current velocity (Designated value) Alarm code, Status signal	
Positioner 2 mode	Positioner 2 mode is programmable up to 256 positions of data to designate stop positions, and this mode does not allow monitoring of the current position. This mode has less in/out data transfer volume than the positioner 1 mode.	Target position number Control signal End position number Status signal	
Positioner 3 mode	Positioner 3 mode is programmable up to 256 positions of data to designate stop positions, and this mode does not allow monitoring of the current position. This mode has less in/out data transfer volume from the positioner 2 mode, and operates under minimum number of signals..	Target position number Control signal End position number Status signal	
SEP I/O	This mode allows the same functions with the field network as the PIO controlled motion mode 0 to 5 as described in the previous page.		Please refer to the PIO controlled motion mode.

(*1) Only the positioner 3 mode and the SEP I/O mode are available with CompoNet and MECHATROLINK.

Table of General Specification

Specification item		Description					
Number of axes in the controller		8 axes MAX					
Controller/ Motor input power		DC24V ±10%					
Controller power supply		2A					
Controller inrush current		5A MAX, under 30 ms					
Motor consumption current	Servo motor type	Rated ampere	Maximum		Pulse motor type	Rated ampere	Maximum
			Energy saver	Standard/Hi-accel./decel.			
	2W	0.8A		4.6A	20P	1.0A	2.0A
	5W	1.0A		6.4A	28P	1.0A	2.0A
	10W(RCL)	1.3A		6.4A	35P	2.0A	2.0A
	10W(RCA/RCA2)		2.5A	4.4A			
	20W	1.3A	2.5A	4.4A	42P	2.0A	2.0A
20W(20S type)	1.7A	3.4A	5.1A				
30W	1.3A	2.2A	4.4A	56P	2.0A	2.0A	
Motor inrush current		Slot numbers x 10A MAX, under 5ms					
Motor-encoder cable length		Maximum length 20m (note) for absolute position					
Serial communication (SIO port:dedicated teaching)		RS485 1ch (Modbus protocol compatible) Velocity 9.6~230.4kbps					
External interface	PIO specification	PIO specification : DC24V dedicated signal in/output; Maximum input of 4 points/axis; Maximum output of 4 points/axis; Maximum cable length 10 m					
	Field network specification	DeviceNet, CC-Link, PROFIBUS-DP, MECHATROLINK, CompoNet, EtherCAT, EtherNet/IP(*)					
Data configuration and input method		PC software application, touch panel teaching pendant, gateway parameter configuration tool					
Data retention memory		Restore the position data and parameter in non-volatile memory (no limited input)					
Positioning points		PIO specification: 2 or 3 points Field network specification: 256 points (no limited input for the simple numerical control and the direct numerical control) (Note) The number of designated positions vary depending on the parameter configuration with motion mode selection.					
LED display (On the front panel)		LED for driver status, 8 LEDs (for each driver board) Status LED, 4 LEDs (PIO specification), 7 LEDs (Fieldbus specification)					
Electromagnetic brake force release		Enable to force-release by transmitting a deactivation signal to each axis (DC24V input).					
Surge protection		Overcurrent protection (An interception semiconductor circuit is furnished on each slot)					
Electric shock protection		Class I basic insulation					
Insulation resistance		DC500V 10MΩ					
Weight		620, 690g with the absolute position encoder specification plus 1950 g absolute data backup battery (8-axis specification)					
Cooling method		Forced- air cooling					
Required ambient temperature/humidity for operation		0~40°C, under 85% RH (non-condensing)					
Vibration resistance		Frequency 10~57Hz/Amplitude 0.075mm Frequency 57~150Hz/Acceleration 9.8m/s ² Each XYZ direction, sweep time 10 minutes, sweep count 10 times					
Shock resistance		150mm/s ² , 11 ms half sine wave pulse, each XYZ direction 3 times					
International Protection code		IP20					

Exterior Dimensions

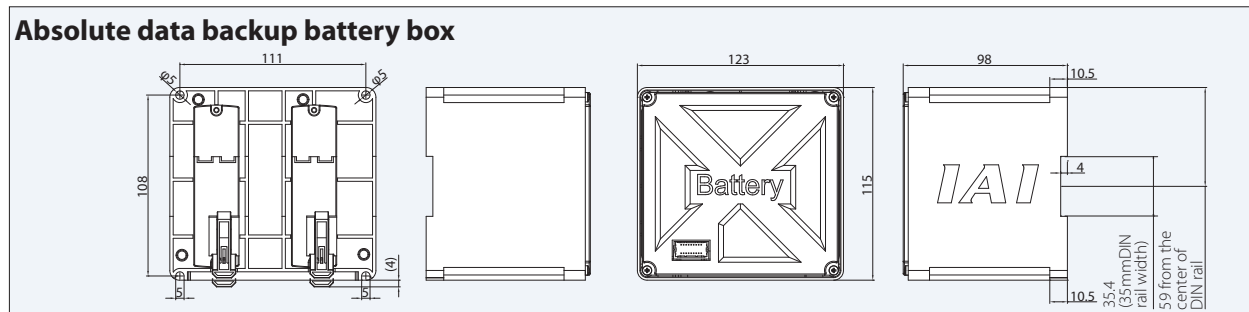
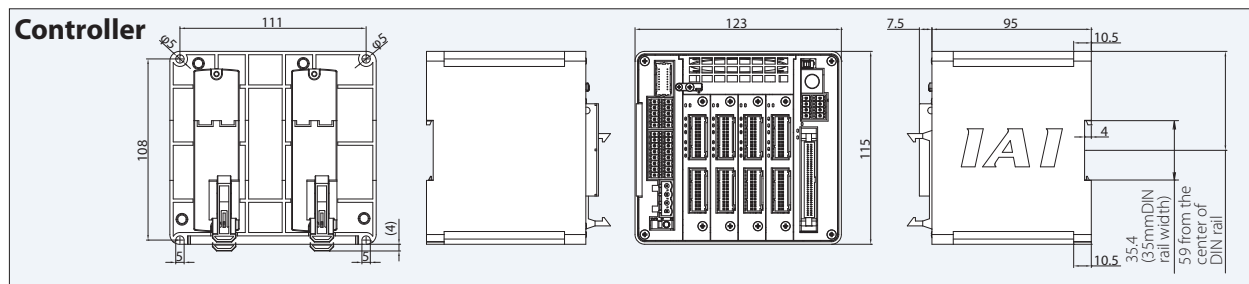

Names of the MSEP Controller components

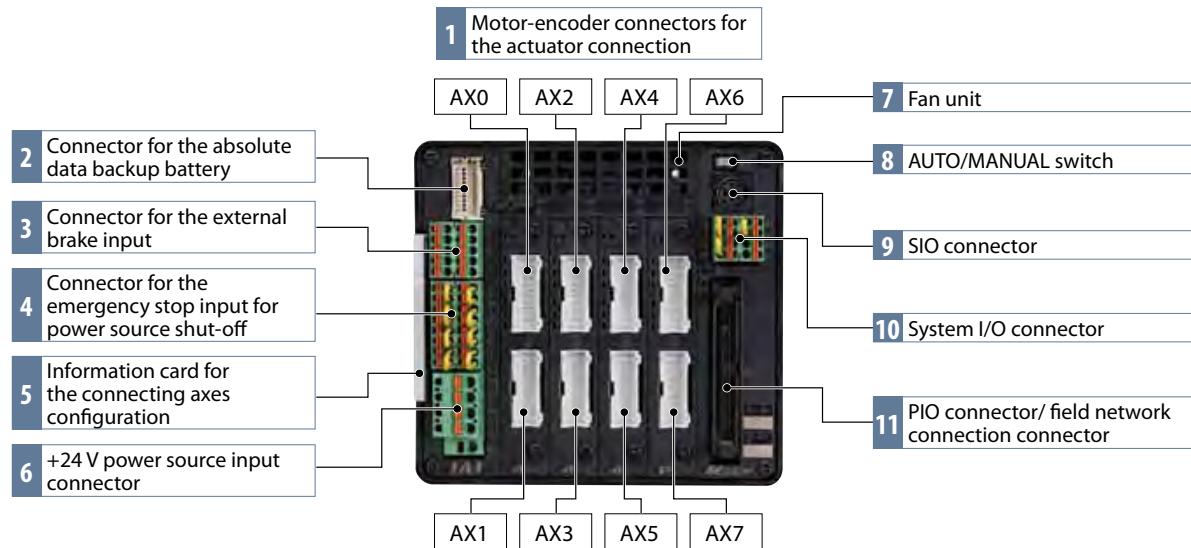

Note) All the connectors are represented as AX0 through AX7. Please be aware that the motor-encoder cable for the first axis is to be connected to AX0 and the second axis to AX1 respectively.

Descriptions of the components

- 1 Motor-encoder connectors for the actuator connection**
Connect motor-encoder cable to the actuator
- 2 Connector for the absolute data backup battery**
Connect the absolute data backup battery if the controller has the absolute position encoder specification
- 3 Connector for the external brake input**
The connector to input a signal to release the brake for the actuator externally.
- 4 Connector for the emergency stop input for power source shut-off**
The emergency stop input connector to connect in/output terminal of the external relay of the motor drive shut-off and each driver slot (*).
- 5 Information card for configuration of the connecting axes**
The information card contains information regarding the configuration of the controller axes which is removable to examine the contents.
- 6 +24 V power source input connector**
The main power source connector for the controller: Motor drive source shut-down is possible while restoring the power source for the controller unit in case of an emergency shut-down; This is because the terminals for the power source of the motor and the controller are separate.
- 7 Fan unit**
Easily replaceable fan unit. (Replacement fan unit: Model MSEP-FU)
- 8 AUTO/MANUAL switch**
To switch automatic operation to/from manual operation
- 9 SIO connector**
To connect teaching box and the connecting cable for PC software
- 10 System I/O connector**
The connector for remote AUTO/MANU switch input and emergency stop input for the entire controller with functions including an external regeneration-resistance expansion terminal.
- 11 PIO connector/ field network connection connector**
The PIO specification — connects to a 68-pin ribbon I/O cable.
The field network specification — connects to a field network type specified on the MSEP controller.

(*1) The shut-off feature is available on a single slot basis which is for two axes per slot. Please note that a single axis basis cannot be accommodated.

Options

Teaching pendant

Summary Teaching device for positioning input, test operation, and monitoring.

Model **CON-PTA-C** (Touch panel teaching pendant)

Setting

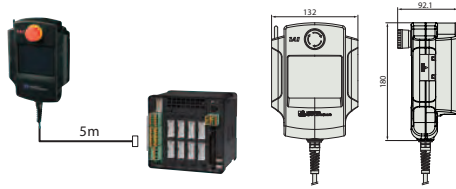

Specification

Item	CON-PTA-C
Data input	○
Actuator motion	○
Operating ambient temperature/humidity	Temperature 0 to 40°C, humidity 85%RH or less
Operating environment	Free from corrosive gas and especially, considerably dusty condition
Protection degree	IP40
Weight	Approximately 570g
Cable length	5m
Display	65536 color White LED back light
Standard price	-

PC software (Windows only) * For the field network specification, the PC software is required.

Summary A startup support software for inputting positions, performing test runs, and monitoring. With enhancements for adjustment functions, the startup time is shortened.

Model **RCM-101-MW**

(External device communication cable + RS232 conversion unit)

Setting

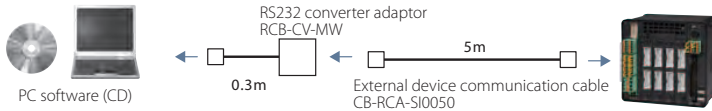

Model

RCM-101-USB (External device communication cable + USB converter adaptor + USB cable)

Setting

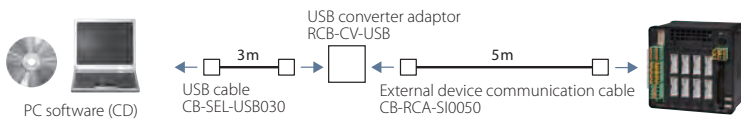

External regeneration resistor

Summary The regeneration resistor converts regenerated current dissipated during deceleration of the motor load into heat. The MSEP controller has an internal regeneration resistor for ordinary operations, however, depending on the operational condition, please install an external regeneration resistor if the internal regeneration resistor capacity is insufficient.

Note: When 3 or more servo actuators with the HA option are used then a regeneration resistor is recommended to convert the excess motor current into heat.

Model **RER-1**

Exterior dimensions

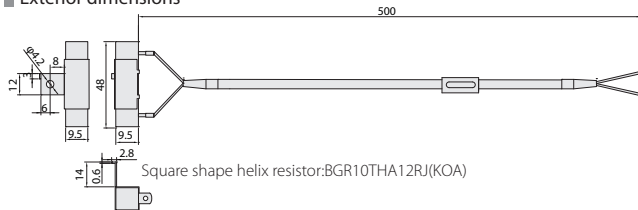

Driver board

Summary A supplement or modification to the driver board is feasible with the MSEP controller. When the actuator that control motions needs to be modified, just replacing the driver board would serve the purpose without changing the entire controller. (The parameters need to be adjusted when changing the driver board)

Model

Type		Model	Standard price	
For the pulse motor	Incremental	1-axis	MSEP-PD1-I	-
		2-axis	MSEP-PD2-I	-
	Absolute position encoder	1-axis	MSEP-PD1-A	-
		2-axis	MSEP-PD2-A	-
For the servo motor	Incremental	1-axis	MSEP-AD1-I	-
		2-axis	MSEP-AD2-I	-
	Absolute position encoder	1-axis	MSEP-AD1-A	-
		2-axis	MSEP-AD2-A	-

Box for the absolute data backup battery

Summary If the absolute position encoder specification is selected with code ABB, the absolute data backup battery box is included with the controller. However, if the battery box is ordered as a separate unit, it does not include the battery but just the box itself. If the battery is needed, please purchase it separately. (Model: AB-7).

Model **MSEP-ABB** (Battery not included)

Exterior dimensions See P12

* A cable (Model CB-MSEP-AB005) that connects the absolute data backup battery box to the MSEP is included with the box.

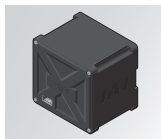

Replacement battery

Summary The replacement battery for the absolute data backup battery box.

Model **AB-7**



Replacement fan unit

Model **MSEP-FU**

Service parts

Integrated Motor-Encoder Cable/ Motor-Encoder Robot Cable for RCP4

Model **CB-CA-MPA** [] [] [] / **CB-CA-MPA** [] [] [] -RB

* Please indicate cable length (L) in [] [] [], maximum 20 m. e.g) 080=8m

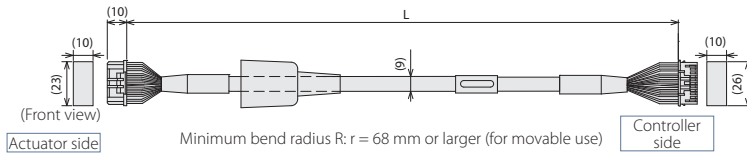

* The robot cable is designed for flex-resistance. Please use the robot cable if the cable has to be installed through the cable track.

Actuator side 1-1827863-1 (AMP)

Pin No.	Signal name	Color
A1	ØA/U	Blue(Black)
B1	VMM/V	Orange (White)
A2	Ø A/W	Green (Brown)
B2	ØB/L	Brown (Green)
A3	VMM/-	Gray (Yellow)
B3	Ø B/-	Red (Red)
A4	LS+/BK+	Black (Orange)
B4	LS-/BK-	Yellow (Gray)
A6	-/A-	Blue (White)
B6	-/A-	Orange (Yellow)
A7	A+/B+	Green (Red)
B7	A-/B-	Brown (Green)
A8	B+/Z+	Gray (Black)
B8	B-/Z-	Red (Brown)
A5	BK+/LS+	Blue (Black)
B5	BK-/LS-	Orange (Brown)
A9	LS_GND	Green (Green)
B9	VPS	Brown (Red)
A10	VCC	Gray (White)
B10	GND	Red (Yellow)
A11	FG	Black (-)

Controller side PADP-24V-1-S (JST)

Pin No.	Signal name	Color
1	ØA/U	Blue (Black)
2	VMM/V	Orange (White)
5	Ø A/W	Green (Brown)
3	ØB/L	Brown (Green)
4	VMM/-	Gray (Yellow)
6	Ø B/-	Red (Red)
7	LS+/BK+	Black (Orange)
8	LS-/BK-	Yellow (Gray)
11	-/A-	Blue (White)
12	-/A-	Orange (Yellow)
13	A+/B+	Green (Red)
14	A-/B-	Brown (Green)
15	B+/Z+	Gray (Black)
16	B-/Z-	Red (Brown)
9	BK+/LS+	Blue (Black)
10	BK-/LS-	Orange (Brown)
20	LS_GND	Green (Green)
18	VPS	Brown (Red)
17	VCC	Gray (White)
19	GND	Red (Yellow)
21	FG	Black (-)
22	NC	NC
23	NC	NC
24	FG	Black (-)

* Color in () indicates color of robot cable

Integrated Motor-Encoder Cable for RCP3/RCA2 and others

Model **CB-APSEP-MPA** [] [] []

* Robot cable is the standard specification. Please indicate cable length (L) in [] [] [], maximum 20 m. e.g) 080=8m

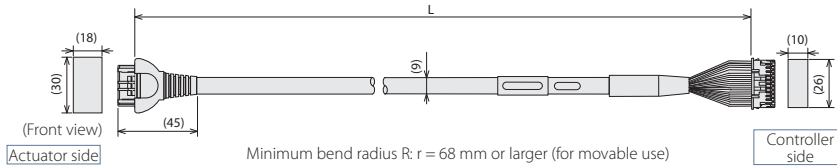

Actuator side

Pin number	Signal name
A1	Black (ØA) (U)
B1	White (VMM) (V)
A2	Brown (ØA) (W)
B2	Green (ØB) (L)
A3	Yellow (VMM) (-)
B3	Red (ØB) (-)
A4	Orange (LS+) (BK+)
B4	Gray (LS-) (BK-)
A6	White (-) (A+)
B6	Yellow (-) (A-)
A7	Red (A+) (B+)
A4	Green (A-) (B-)
A8	Black (B+) (Z+)
B8	Brown (B-) (Z-)
A5	Black (label) (BK+) (LS+)
B5	Brown (label) (BK-) (LS-)
A9	Green (label) (GND) (LS)
B9	Red (label) (VPS) (VPS)
A10	White (label) (VCC) (VCC)
B10	Yellow (label) (GND) (GND)
A11	NC
B11	Shield (FG) (FG)
NC	NC
NC	NC

Controller side

Pin number	Signal name
1	Black (ØA) (U)
2	White (VMM) (V)
5	Brown (ØA) (W)
3	Green (ØB) (L)
4	Yellow (VMM) (-)
6	Red (ØB) (-)
7	Orange (LS+) (BK+)
8	Gray (LS-) (BK-)
11	NC
12	NC
13	Red (A+) (B+)
14	Green (A-) (B-)
15	Black (B+) (Z+)
16	Brown (B-) (Z-)
9	Black (label) (BK+) (LS+)
10	Brown (label) (BK-) (LS-)
20	Green (label) (GND) (LS)
18	Red (label) (VPS) (VPS)
17	White (label) (VCC) (VCC)
19	Yellow (label) (GND) (GND)
21	NC
22	NC
23	NC
24	Shield (FG) (FG)
NC	NC
NC	NC

Integrated Motor-Encoder Cable for RCP2

Model **CB-PSEP-MPA** [] [] []

* Robot cable is the standard specification. Please indicates cable length (L) in [] [] [], maximum 20 m. e.g) 080=8m

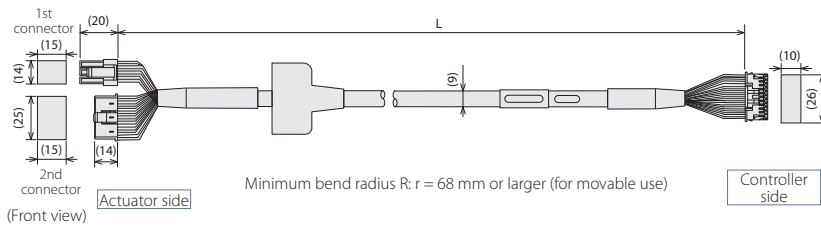

Actuator side

Pin number	Signal name
1	Black (ØA)
2	White (VMM)
4	Red (ØB)
5	Green (VMM)
3	Brown (ØA)
6	Yellow (ØB)
7	Orange (BK-)
17	Gray (BK-)
5	NC
6	NC
13	Black (LS+)
14	Brown (LS-)
1	White (A+)
2	Yellow (A-)
3	Red (B+)
4	Green (B-)
10	Black (label) (BK+) (LS+)
11	White (label) (BK-) (LS-)
14	Yellow (label) (VCC)
17	Red (label) (VPS)
18	Green (label) (VPS)
19	White (label) (VCC)
20	Yellow (label) (GND)
15	Green (label) (Spare)
7	NC
8	NC
21	NC
22	NC
23	NC
24	Shield (FG)

Controller side

Integrated Motor-Encoder Cable for RCA

Model **CB-ASEP-MPA** [] [] []

* Robot cable is the standard specification. Please indicates cable length (L) in [] [] [], maximum 20 m. e.g) 080=8m

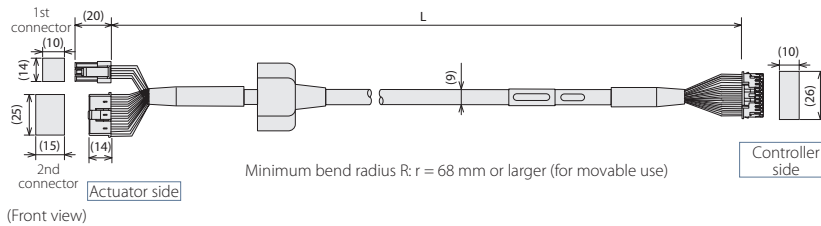

Actuator side

Pin number	Signal name
1	Red (U)
2	Yellow (V)
NC	NC
3	NC
5	Black (W)
NC	NC
7	Orange (BK+)
18	Gray (BK-)
17	Black (LS+)
9	Brown (LS-)
10	White (A+)
11	Yellow (A-)
12	Red (B+)
13	Green (B-)
14	Black (label) (BK+) (LS+)
15	White (label) (BK-) (LS-)
16	Brown (label) (VCC)
17	Red (label) (VPS)
18	Yellow (label) (VPS)
19	Green (label) (Spare)
20	NC
21	NC
22	NC
23	NC
24	Shield (FG)

Controller side

Integrated Motor-Encoder Cable for RCP2 Compact Rotary

Model **CB-RPSEP-MPA** [] [] []

* Robot cable is the standard specification. Please indicate cable length (L) in [] [] [], maximum 20 m. e.g) 080=8m

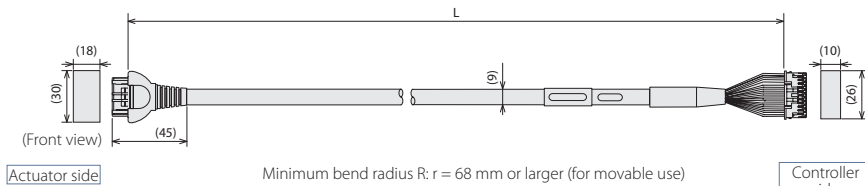

Actuator side

Pin number	Signal name
A1	Black (ØA)
B1	White (VMM)
A2	Brown (ØA)
B2	Green (ØB)
A3	Yellow (VMM)
B3	Red (ØB)
A6	Orange (LS+)
B6	Gray (LS-)
A7	Red (A+)
B7	Green (A-)
A8	Black (B+)
B8	Brown (B-)
A4	NC
B4	NC
A5	Black (label) (BK+) (LS+)
B5	Brown (label) (BK-) (LS-)
A9	Green (label) (GND) (LS)
B9	Red (label) (VPS)
A10	White (label) (VCC)
B10	Yellow (label) (GND)
A11	NC
B11	Shield (FG) (FG)
NC	NC
NC	NC

Controller side