

INTRODUCTION TO ROBO CYLINDER



Easy Programming:
Acceleration and deceleration can be set independent of each other, providing excellent control of work. Dramatically reduce work damage and error.



Stainless Steel Dust Strip:
Keeps contaminants out of the system, prolonging actuator performance and efficiency.

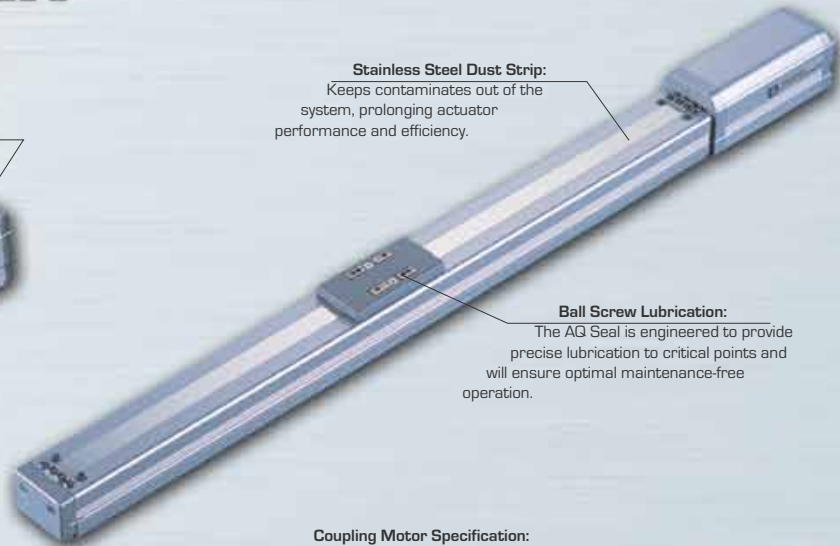

Ball Screw Lubrication:
The AG Seal is engineered to provide precise lubrication to critical points and will ensure optimal maintenance-free operation.

Coupling Motor Specification:
Optimized for fast and easy motor change-outs. Reduce downtime and maximize your return.

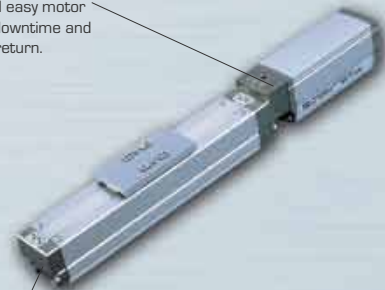

Rod Type Actuators:
Mounts like an air cylinder and operates at speeds of up to 800 mm/s at strokes of 300 mm offering smooth transitions unseen with air cylinders. With up to 1500 positioning points, you can produce a variety of products on the same automation line.

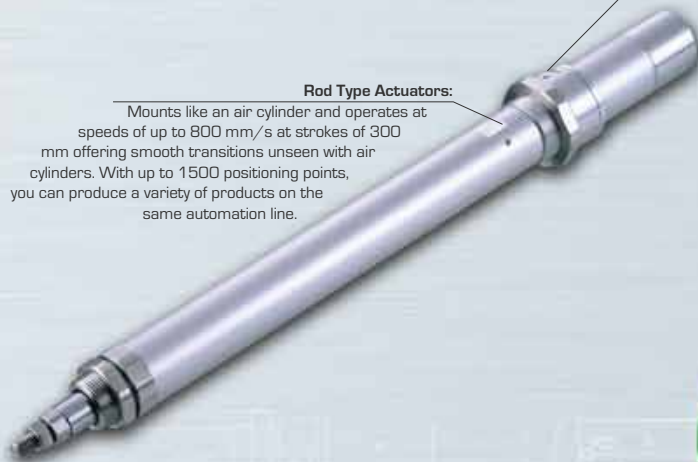

Slider Type Actuators:
Speeds of up to 1500mm/s and stroke lengths of 1200mm, the slider type actuator performs flawlessly in many applications.



Quality & Innovation



OVER 30 YEARS OF IAI!

ESTABLISHED IN 1976, IAI HAS GROWN GLOBALLY TO SERVE OVER 12 COUNTRIES. IAI HAS 24 REGIONAL OFFICES IN JAPAN AND IS PROUD TO ANNOUNCE A NEWLY CONSTRUCTED HEADQUARTERS, WITH AN ADJACENT STATE OF THE ART MANUFACTURING FACILITY TO PRODUCE THE HIGHEST QUALITY AUTOMATION ROBOTS. IAI IS CONSTANTLY STRIVING IN THE PURSUIT OF 'QUALITY AND INNOVATION.' OUR FOCUS IS ALWAYS ON OUR CUSTOMERS AND THEIR NEEDS TO OFFER HIGH QUALITY AND INNOVATIVE SOLUTIONS TAILORED FOR SPECIFIC CUSTOMER APPLICATIONS. IAI AMERICA INC. WAS ESTABLISHED IN 1989 TO BETTER SERVE THE NEEDS OF FACTORY AUTOMATION. WITH 3 MAIN OFFICES IN THE UNITED STATES, SUPPORT FROM IAI'S EXPERIENCED ENGINEERS IS ALWAYS JUST A PHONE CALL AWAY.

FROM OUR EASY TO USE SOFTWARE, TO COMPLETE AUTOMATION SOLUTIONS, WE PROVIDE YOU WITH THE TOOLS NECESSARY TO SCALE YOUR BUSINESS. WHEN YOU DEMAND INNOVATIVE AND HIGH QUALITY ROBOTS, EXCELLENT SERVICE AND SUPPORT FOR YOUR UNIQUE NEEDS, DEMAND IAI!



IAI Headquarters

On the windows of the newly constructed headquarters spell out the character for 'heart' in Japanese. This character is rich and meaningful, symbolizing the heart, spirit, attention and sincerity of IAI's commitment to the users of IAI products.

ISO 9001:2000

IAI has been certified for ISO 9001:2000 and JIS Q9001:2000 by an independent auditor to be in conformance with ISO 9001:2000 and JIS 9001:2000. We at IAI are continually improving our methods to produce quality products and services that surpass customer expectations.



RoHS Compliant

IAI is RoHS compliant and recognizes the responsibility in reducing hazardous substances to better serve our customers and our environment.

RoHS

Green Automation



Higher Quality, Lower Running Costs, Sustainability

How much money is leaking out of your system?

The United States Department of Energy, Office of Industrial Technologies has reported that "many facilities have no idea how much their compressed air systems cost on an annual basis, or how much money they could be **saving** by improving the performance of these systems." Do you know how much money is leaking out of your system?



The excessive cost of leaks

An example of how expensive one small leak can cost, consider the figure below:

Size	Cost per Year	Costs calculated using electricity rate of \$0.096 per kWh*, assuming constant operation and an efficient compressor. *Cost adjusted for average commercial retail price of electricity (Nov. 2007)
● 1/16"	\$1,004.16	
● 1/8"	\$4,022.40	
● 1/4"	\$16,093.44	

Just one small 1/4" hole can cost you \$16,093.44 per year! Even without a visible hole, pinhole leaks are very common and add up to a costly energy bill. Energy costs are **skyrocketing** and so will the cost of air leaks that plague most systems. DOE also states "leaks can be a significant source of **wasted** energy in an industrial compressed air system, sometimes wasting 20-30% of a compressor's output." Leaks will drop system pressure and make "air tools function less efficiently, adversely affecting production."

Eliminate your problems with *ROBO Cylinder*

You can **eliminate** costly losses with IAI's *ROBO Cylinder* electric actuator today! *ROBO Cylinder* offers you easy to use software and all of the **benefits** of a high-quality electric actuator. Did you know that the effective energy efficiency of IAI's *ROBO Cylinder* line is 80-90%, while "a typical overall efficiency is around 10%" for a compressed air system"? (U.S. DOE, OIT Sourcebook CAC F2-1)

Power Consumption Test: *ROBO Cylinder* vs Air Cylinder

IAI devised a precision power consumption test procedure to measure energy efficiency. Both the air cylinder and *ROBO Cylinder* were tested with identical variables. Variables included dwell time, cost of electricity, cost of compressed air, speed, payload, stroke, ambient temp and operating time.



ROBO Cylinder
Running Costs only
1/3 to 1/10 of an
Air Cylinder



As the operation frequency increases, the energy requirements of air cylinders increase exponentially, while the power consumption rate remains constant with the energy efficient *ROBO Cylinder*. Therefore, the differentials in power consumption between the two actuators increase as the number of cycles per minute increases. Based on IAI's calculations, when the two actuators are operating at 10 cycles per minute, the *ROBO Cylinder* only requires 1/3 the power of the air cylinder. When the actuators are operating at 30 cycles per minute, the difference is even more profound, with the *ROBO Cylinder* only requiring 1/10 the power of the air cylinder! Keep in mind that no industrial plant uses just one actuator; the more actuators your plant requires, the more savings and ROI with energy efficient *ROBO Cylinders*.

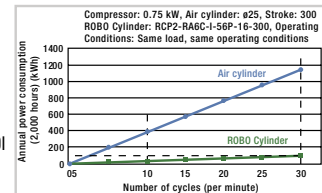

Source:

1. Energy Information Administration, Form EIA-826, "Monthly Electric Sales and Revenue Report with State Distributions Report."
2. Department of Energy, Office of Industrial Technologies: Compressed Air Challenge: "Inappropriate Uses of Compressed Air" Fact Sheet #2
3. Department of Energy, Office of Industrial Technologies: Compressed Air Challenge: "Compressed Air System Leaks" Fact Sheet #7
4. Department of Energy, Office of Industrial Technologies: Compressed Air Challenge: "Compressed Air System Economics" Fact Sheet #9
5. IAI Japan Internal R&D Testing Reports.
6. Pneumatic Energy Evaluation Report by Tokyo Institute of Technology



Model Categories

Controller-integrated Type

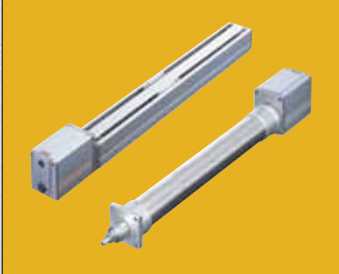

Features ERC2 electric actuators are low-cost, controller-integrated actuators with a built-in controller. You do not need extra space for a separate controller minimizing the control area. These electric actuators are available at affordable prices similar to those of air cylinders, and thus are great economical, high-quality candidates for replacing air cylinders.

Applications Use of multiple actuators in one system. Transfer, raising/lowering, push-out, push-motion.

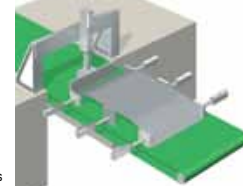

Example: Positioning of automobile rear panels

Slider Type



Features The slider on the actuator moves forward and backward to perform positioning operations. The built-in linear guide helps achieve excellent linearity and also enables handling of an uneven load. Slide-type actuators are available in one of three motor-installation specifications including the coupling type, built-in (direct connection) type and reversing type.

Applications Transfer and positioning along a straight line
Product picking & placement systems consisting of multiple axes



Example: Picking & placement of products

Rod Type



Features The rod extends and contracts from/into the actuator to perform positioning and push-motion operations. You can select one of three guide options including "no guide," "single guide" and "double guides." Rod-type actuators are available in one of three motor-installation specifications including the coupling type, built-in (direct connection) type and reversing type.

Applications Raising/lowering of loads and stackers
Pushing-out of products (pushers)
Press-fitting of loads, crimping

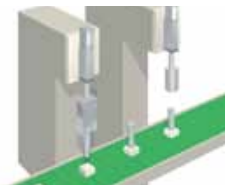

Example: Press-fitting and assembly of resin parts

Table type/ Arm type/Flat type



Features The table or arm on the actuator slides to perform positioning and push-motion operations. The built-in linear guide helps achieve excellent linearity and also enables handling of an uneven load. Compared to rod-type actuators, these actuators allow for easy installation of devices.

Applications Raising/lowering of loads and stockers (Effective for devices and loads having many overhangs)
Pushing-out of products (pushers)



Example: Raising/lowering of inkjet heads

ROBO CYLINDER

Gripper type/ Rotary type



Features Gripper-type actuators allow for adjustment of gripping force to hold even fragile loads with soft gripping action. Rotary-type actuators offer versatility, functioning both as an index station to perform 360-degree positioning operations, and as a conveyor that rotates infinitely in the same direction.

Applications Gripper - Gripping and centering of loads
Rotary - Indexing and rotation/movement of loads



Example: Palletizing of loads using a SCARA robot

Cleanroom specification

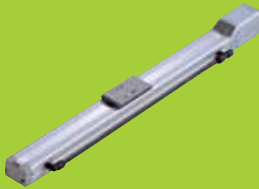

Features These actuators are designed for the cleanroom environment and achieve cleanliness of class 10 (0.1 mm). The stainless sheet prevents dust from being raised inside the actuator, which helps achieve high cleanliness with a light vacuum.

Applications Transfer and positioning inside a clean room

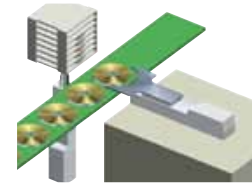

Example: Stacking of discs

Dust-proof/ Splash-proof specification



Features These actuators have an IP65 protective structure to withstand use in a harsh environment where the actuator comes in contact with powder dust, water splashes, etc.

Applications Transfer & positioning structure in machine tools, food processing machines and cleaning systems

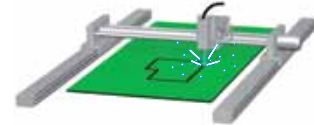

Example: Feeding of water jets

Controller



Features Our controllers support various control methods including positioner control, solenoid-valve control, pulse-train control, serial communication, field network (DeviceNet/CC-Link/Profibus), and program operation.

Applications Simple positioning - Positioner control, solenoid-valve control
At-will control - Pulse-train control, serial communication
Simultaneous control with peripherals - Field network
Independent control - Program control

ROBO Cylinder Series

Pulse Motor Actuators

ERC2 series



The ERC2 series actuators are the affordable **SOLUTION** and benefit from a built-in controller improving usability

Features

1. The built-in controller offers simple wiring.
2. No need for extra installation space for controllers.
3. Exceptional value; actuator price includes the controller.

Controller (Built-in) **Input Power** DC24V

RCP3 series

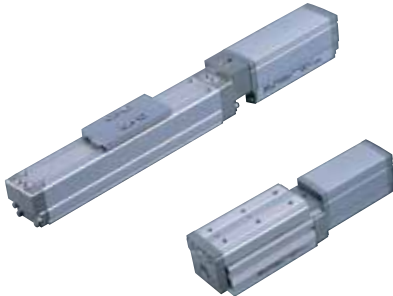

Through improvement of production **TECHNOLOGY**, the new RCP3 series actuators have become even more affordable and easier to use.

Features

1. The table type is constructed with a high-rigidity slide mechanism for greater moment loads.
2. An ultra-slim model with a width of 32 mm/1.26" (SA3 type) is the solution for applications requiring small actuators.
3. Motor change-outs are as easy as unscrewing one bolt.

Controller PCON
PSEL **Input Power** DC24V

RCP2 series



The RCP2 series actuators are high-value and driven by a pulse motor capable of generating high **FORCE** at low speed.

Features

1. Vast variety of unique electric actuators.
2. The characteristics of a pulse motor are utilized to generate strong push force.
3. Various control methods are possible with controller support.

Controller PCON
PSEL **Input Power** DC24V

ROBO CYLINDER

Servo Motor Actuators

RCA2 series

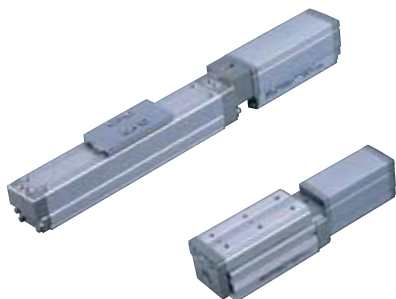

The RCA2 series continues on the path of the RCA series delivering a low cost and UNPARALLELED serviceability

Features

1. The table type is constructed with a high-rigidity slide mechanism for greater moment loads.
2. An ultra-slim model with a width of 32 mm/1.26" (SA3 type) is the solution for applications requiring small actuators.
3. Easy motor change-outs.

Controller	ACON ASEL	Input Power	DC24V
-------------------	--------------	--------------------	-------

RCA series



The RCA series is powered by a 24V servo motor that can be installed in the same manner as air cylinders

Features

1. Various mounting brackets similar to what you normally use with air cylinders are supported.
2. Available in one of three motor-installation specifications including the coupling type, built-in (direct connection) type and reversing type.
3. Home check sensor (optional)
4. Optional high acceleration/deceleration function that enables operations at 1G. A power-saving option that lowers power consumption is also offered.

Controller	ACON ASEL	Input Power	DC24V
-------------------	--------------	--------------------	-------

RCS2 series

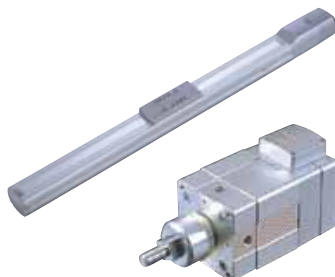

Small/Medium size actuators that can be operated with a 100/200V power supply

Features

1. Max speed of 1,000 mm/s, max load capacity of 60kg, and max stroke of 1,000 mm.
2. With the XSEL controller, 3 or more axes can be combined as cartesian systems.
3. Available in one of three motor-installation specifications including the coupling type, built-in (direct connection) type and reversing type.
4. Optional high acceleration/deceleration function that enables operations at 1G.

Controller	SCON SSEL XSEL	Input Power	AC100V/200V
-------------------	----------------------	--------------------	-------------

Actuator Type Features

Mini Slider type

The slider on the main body moves back and forth until it is positioned.

- Features**
- The motor can easily perform switching operations for the unit model.
 - Select from Reversing type with a reduced total length and Slim Straight type (Coupling type).

Usage Used for jig and workpiece positioning, table travel, etc

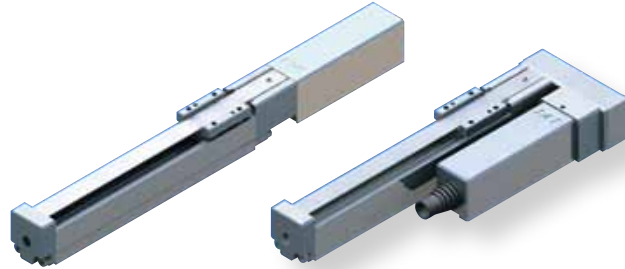

Motor Unit Coupling type

Motor Unit Reversing type

Mini Rod type

The rod extends and retracts from the main body, gets into position and presses.

- Features**
- Select from Slim Motor Unit types and Short Length types having greatly reduced overall length.
 - Select from Guide types with highly rigid/linear built-in guides and Non-Guide types having drastically miniaturized main body sizes.

Usage Used for raising/lowering products and jigs, pushing, clamping, etc.



Short Length,
Double-Guide
Free Mount type

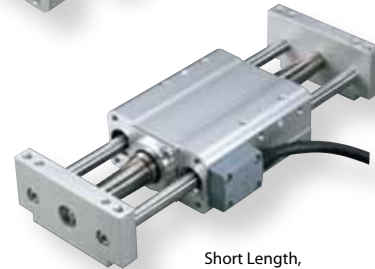

Short Length,
Double-Guide
Slide Unit type

Motor Unit
Coupling type

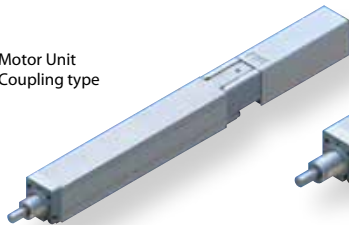

Motor Unit
Reversing type

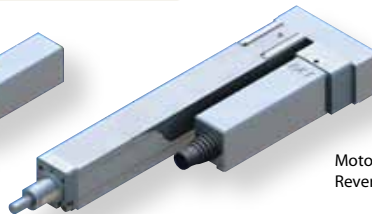

Short Length,
Fixed Nut type



Short Length,
Tapped Hole type



Short Length,
Single-Guide
Free Mount type

Mini Table type

The table on the main body slides until it is positioned.

Features

- Comes equipped with an integrated guide that keeps overhung loads balanced.
- Select from Compact, Short Length types and Long Stroke Motor Unit types.

Usage

Used for raising/lowering products and jigs, horizontal moving, and pushing (handles overhung loads from the main unit).

Motor Unit
Reversing type

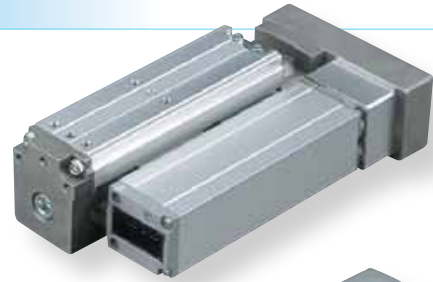

Motor Unit
Coupling type

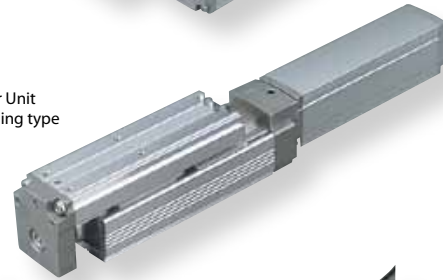

Short Length
Wide type



Short Length
Flat type



Short Length
Compact type

Mini Linear Servo type

High speed, lightweight parts transfer.

Features

- Equipped with a high acceleration/ deceleration linear motor capable of operation at up to 2G.
- Available in Slider type and Rod type. Slider type comes in six different models for each size and stroke.
- The Multi-slider type comes with two sliders on one axis that can be independently operated.

Usage

Used for transfers requiring short cycle times, etc.

Micro Slider
Slim type

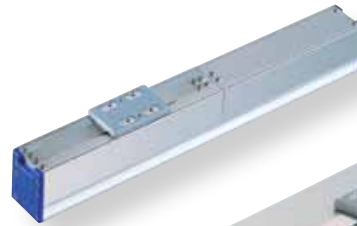

Micro Slider
Long Stroke Type
single slider



Micro Slider
Long Stroke Type
Multi-slider

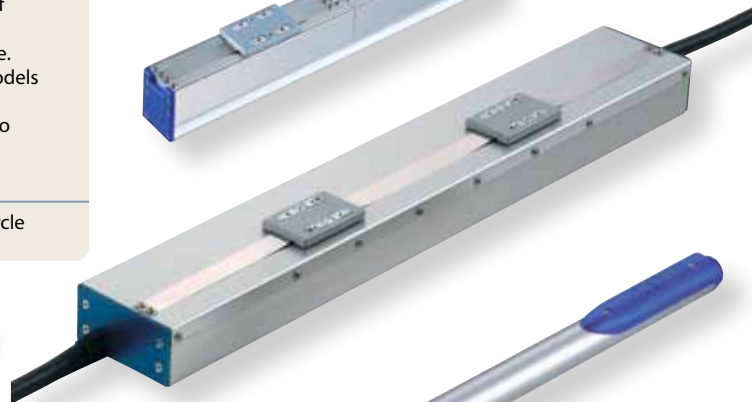

Micro Cylinder
Slim type



Controller



New PSEP/ASEP controllers designed exclusively for 2-point and 3-point positioning



Unlike conventional controllers, the PSEP/ASEP require only a few movement positions. These "Simple, Easy Positioner" controllers are for applications where the actuator travels only between two or three points, which is usually the case with air cylinders.

If you have been using air cylinders and are unhappy with the long time needed to change movement positions or want to stop actuator movement between two points, you can use the ROBO Cylinder with PSEP/ASEP controllers. We also have an IP53 rated dustproof type that can be placed near the actuator for operation as is done with solenoid valves.

PSEP/ASEP controllers are not just for the new Mini ROBO Cylinder lineup. They can also be used with existing ROBO Cylinders. Existing controllers can also be used with the new Robo Mini Cylinders. Please use them according to the application..

Existing models



New Mini ROBO Cylinder

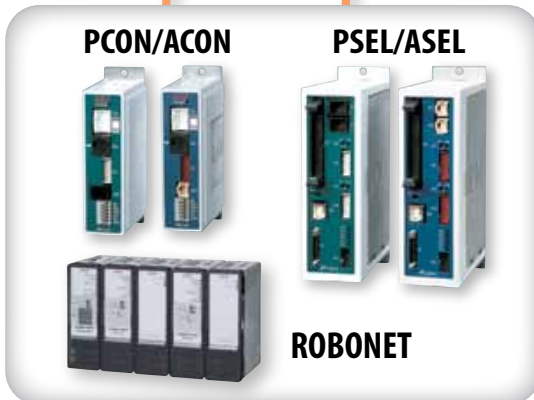
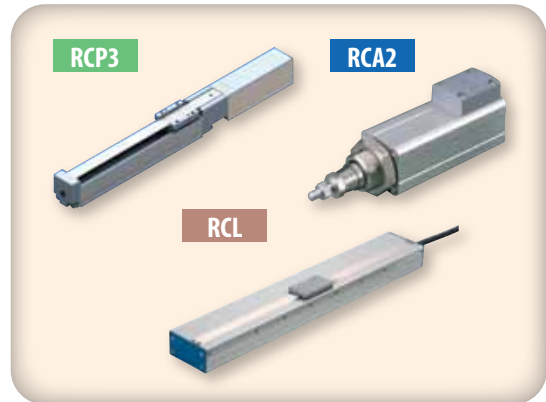

Operates using the same signals used for air cylinder solenoid valves.

PSEP/ASEP operating methods

PSEP/ASEP controllers can be operated with the same signals used for air cylinder solenoid valves.

Solenoid valves come in two types: Single solenoids and Double solenoids. The PSEP/ASEP supports signals for both.

When using an air cylinder solenoid valve:

<Single solenoid>

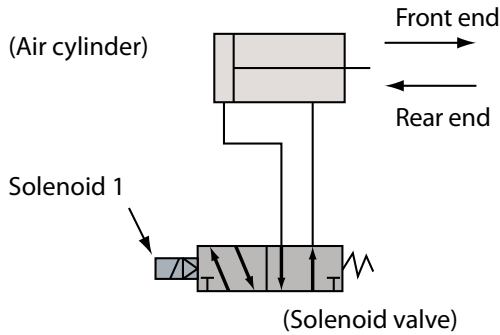

Signal to solenoid 1	Rod movement
ON	Front end
OFF	Rear end

<Double solenoid>

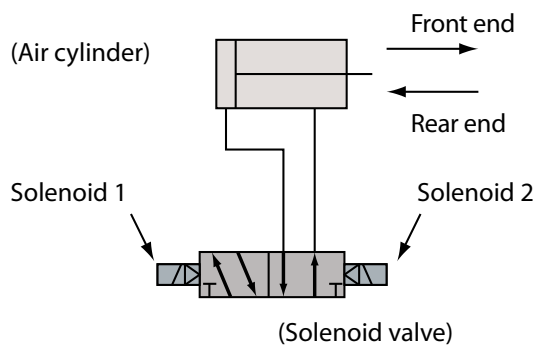

Signal to solenoid 1	Signal to solenoid 2	Rod movement
ON	OFF	Front end
OFF	ON	Rear end

PSEP/ASEP:

<Replacement of single solenoid>

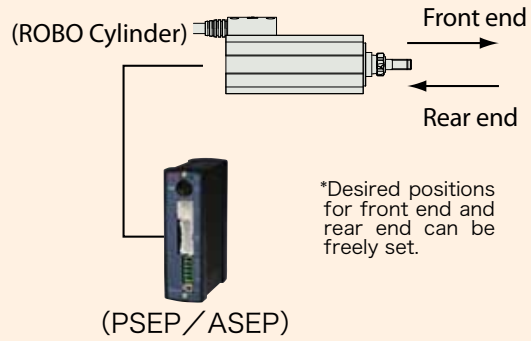

Signal to controller Input 0	Rod movement
ON	Front end
OFF	Rear end

<Replacement of double solenoid>

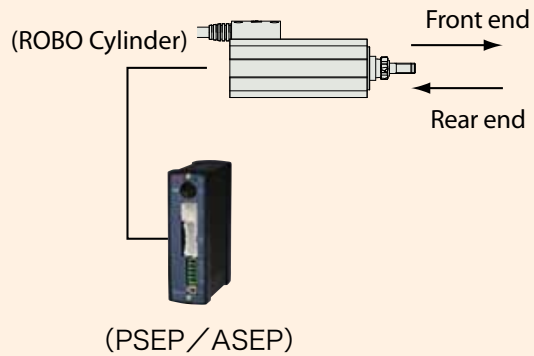

Signal to controller Input 1	Signal to controller Input 0	Rod movement
ON	OFF	Front end
OFF	ON	Rear end

※The main body moves between the same two points listed above, but it can also travel between three points by switching the parameters.

New ROBO Cylinder Multi-Axes

Multi-Axes System

IK Series

ROBO Cylinder IK Series Your Multi-Axes Solution!

Low Cost

With the IK Series, your ROI is realized faster than you can imagine, making IAI the perfect complete solution for any application!

Easy Assembly

The complete kit includes everything needed for fast and easy assembly



Motor Options

The IK Series is offered in both pulse and servo motors. Choose the pulse motor for applications requiring high thrust at low speeds. Choose the servo motor for applications requiring constant thrust regardless of the operating speed.



High Functionality

Combined with the PCON/PSEL/SCON/SSEL/XSEL controllers, complex programming is made easy.

12

Sold & Serviced By:

 **ELECTROMATE**

Toll Free Phone (877) SERV098

Toll Free Fax (877) SERV099

www.electromate.com

sales@electromate.com

ROBO CYLINDER

Multi-Axes System

IK Series Parts

The IK Series offers the easy cost effective **SOLUTION** tailored to your needs. The kit comprises the following components needed to assemble a cartesian robot



Note: The above images are provided for reference purposes only. The actual components may vary depending on the combination type, direction, etc.

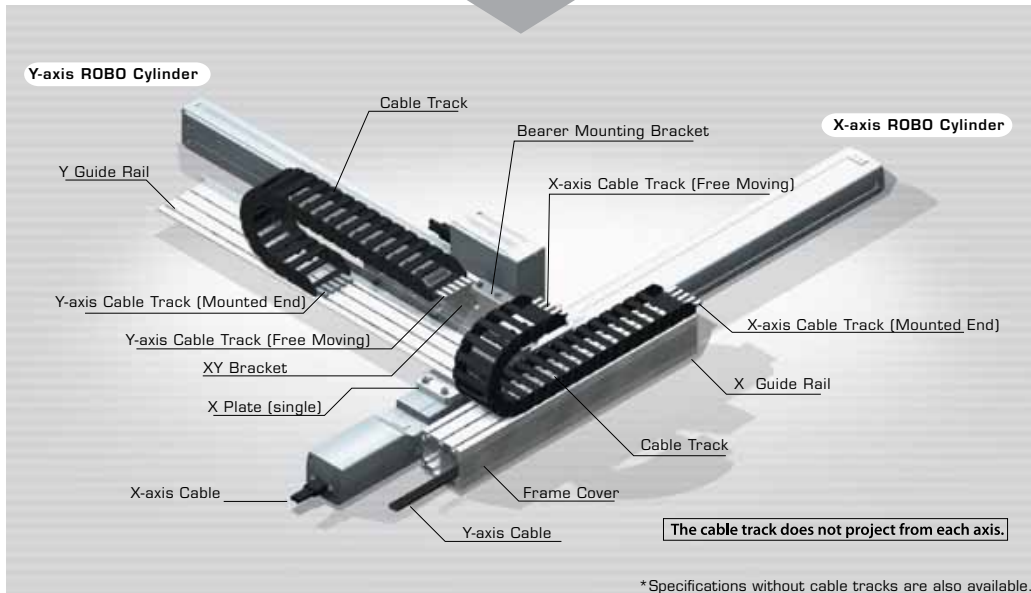

New ROBO Cylinder Lineup

ROBO Cylinder

RCP3/RCA2 Series

The New ROBO Cylinders have become more affordable and easier to use

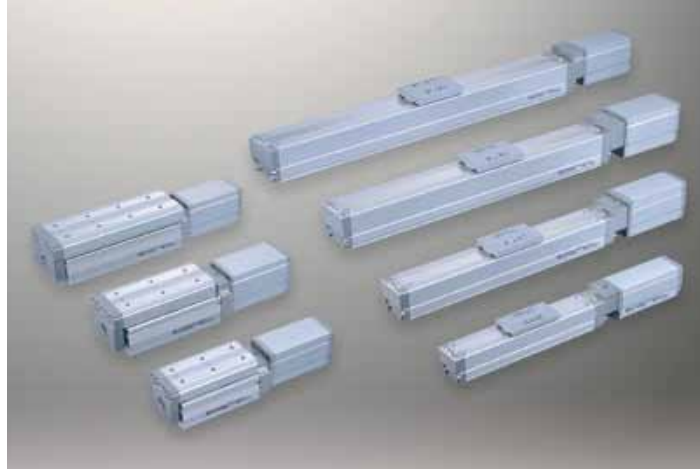

Our Advancement for Your Benefit

We have taken the time to completely re-engineer the guide, ball screws and servo motor to reduce manufacturing costs. We are proud to make IAI's high-quality electric actuators even more affordable!

New Table Type Actuators

Perfect for applications that require the handling of high moment loads, the new Table Type actuators have a built-in guide to handle loads with ease.

New Ultra-slim Slider Type (32mm in width)

The ideal for applications with space constraints, the new ultra-slim type SA3 (32mm wide) actuator is the ideal choice when only the best will do.

No-Cover Option

You can choose to have your actuator supplied without the exterior covers and stainless steel dust cover for even more cost savings.

Pulse-Motor RCP3 Series & Servo-Motor RCA2 Series

The RCP3 series is driven by a pulse motor and is affordably priced offering excellent push-motion performance, etc. The RCA2 series is driven by a servo motor and achieves high-speed movement while also ensuring quiet operation.

High-Speed Type

RCA/RCS2 Series

Achieve 1G with the High-Acceleration/Deceleration ROBO Cylinders

Shorten your Cycle Time with Increased Acceleration/Deceleration

Since the acceleration can be increased to a max of 1G, the high-speed actuators will allow shorter cycle times speeding up production.

Keep your Load Capacity even when the Acceleration/Deceleration is increased

Even with 1G acceleration/deceleration, the RCA/RCS2 series can operate at the same load capacity as lower acceleration.

*The maximum load capacity will not increase when the acceleration/deceleration is decreased.



RCA / RCS2

ROBO CYLINDER

Ultra-High Thrust Type

RCS2-RA13R Series

Ultra-High Thrust Actuators Capable of **2t** Press Force

With the high-output servo motor, these motorized actuators can perform push-motion operation with a maximum push force of 2 tons and also achieve high-precision position control. The RCS2-RA13R series lets you adjust the push force and control positions, which are difficult to do with hydraulic actuators.



RA13R

Application Examples

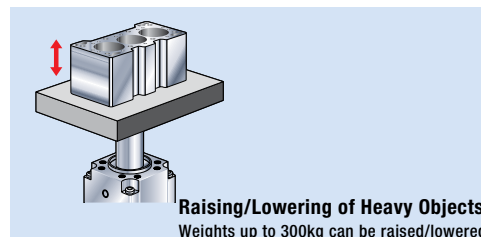
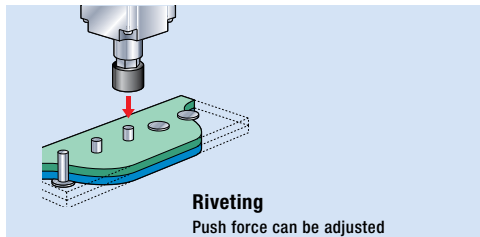
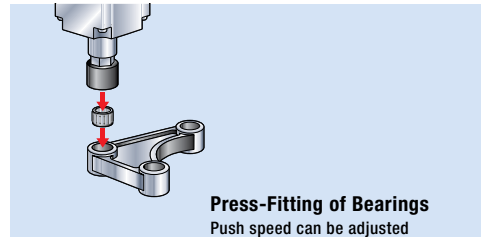
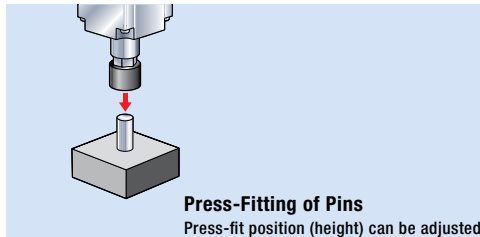

Rotary Type

RCP2-RTBL/RTCL Series

Multiple Rotation Actuators Capable of Rotating Continuously in the Same Direction

Application Example

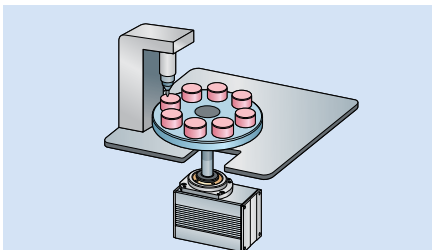

RCP2-RTBL/RTCL used in an index table (linked rotation) for processing parts

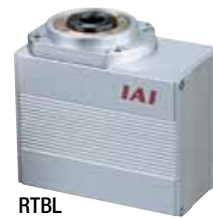

Positioning Operations Involving Rotations of 360 Degrees or More

Since there are no stoppers, positioning operations involving rotations of 360 degrees or more are supported

Multiple Rotation Operations

Since the RCP2-RTBL/RTCL series can be operated in the same rotating direction, the series is ideal for applications where loads are fed continuously in the same direction.

*The multiple rotation operation mode, each travel is limited to a range within +/-360 degrees.

New ROBO Cylinder Lineup

ROBO Cylinder Long-Stroke Gripper **RCP2-GRST** **New**

Ultra-Small High Speed Linear Servo Actuator with Up to 2G Acceleration

- Strokes of up to 100mm (50mm each side)
- High-Speed Specification with Higher Opening/Closing Speeds
- High Gripping Forces up to 40N
- Selectable Cable Exit Direction



RCP2-GRSS/GRLS

Small Electric Gripper

The new motorized grippers achieve high grip force and long stroke in a compact body.



Teach Pendant **CON-T/SEL-T (TD)**

A New Teach Pendant Series Offering Improved Environmental Resistance and Safety Specifications

IP54 Protection
The excellent dust-proof/splash-proof performance makes the teach pendants usable in an undesirable environment where the teach pendant comes in contact with fine particles and moisture.

Compliance with the CE Mark Standard (ANSI standard)
All models comply with the CE Mark standard. The SEL-TD type is also UL and ANSI-compliant.



High-Output Actuator Controller **PCON-CF**

The PCON-CF Controller is Designed Exclusively for use with RCP2 Series High-Output Motors



ROBO Cylinder High-Thrust Type RCP2-RA10C



ROBO Cylinder High-Speed Type RCP2-HS8C/HS8R



ROBO Cylinder Waterproof Type RCP2W-SA16C



ROBO CYLINDER

Network Controller **ROBONET**

A New Concept: Network Controller that Significantly Reduces the Hassle of Wiring and Installation

Connection to Field Networks

The RoboNet supports many major network protocols such as DeviceNet, CC-Link and ProfiBus.

Reduced Man-Hours Through Wire-Saving Design

Since the I/O signals can be wired using a single dedicated network cable, wiring man-hours can be reduced significantly.

Easy Serial Communication Using Function Blocks

Function blocks that eliminate the need for communication programs are available as options (provided free of charge)

Operation by Numerical Specification of Moving Position, Speed, Etc.

Instead of registering positions beforehand, you can operate your system by sending desired positions and speeds as data.

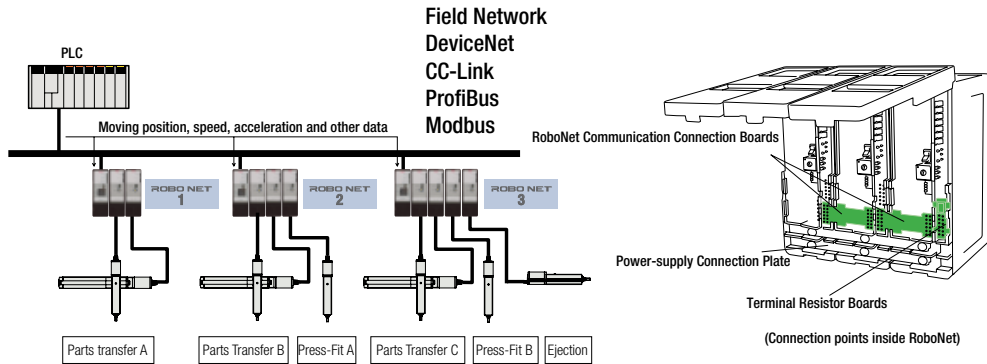

Simple Absolute Unit **PCON/ACON-ABU**

All you Need is to Connect your Incremental Actuator to a PCON/ACON Controller, and the Actuator can be Used as a Simple Absolute Actuator. (The simple absolute unit is also set in RoboNet)

No Need for Home Return













The built-in rechargeable battery in the simple absolute unit retains the encoder data even after the controller power is cut off. Accordingly, the actuator will not require home return the next time the power is turned on.

Retention of Encoder Data for up to 20 Days

Encoder data can be retained for up to 20 consecutive days.



Controllers

Supported Controllers	Controllers		
	RCP2 RCP3 series	RCL RCA RCA2 series	RCS2 series
Position controller	24 VDC pulse motor type	24 VDC servo motor type	200 VAC servo motor type
<p>Positioner Type These controllers support a maximum of 512 positioning points. You can also use it as a solenoid valve controller or serial communications controller, simply by changing the mode setting.</p> <p>Solenoid Valve Type Controls are made easy with effortless 3-point positioning. You can use the same solenoid-valve control operations you are already familiar with on your air cylinders.</p> <p>Pulse-Train Input Type These controllers eliminate the need to input positions in advance. They are ideal in applications require many or complex operation patterns, or where flexibility is required in changing speed and other settings.</p> <p>Serial Communication Type These controllers are used to connect to DeviceNet, CC-Link and FieldBus via a gateway unit. Their compact, low-cost construction is perfect for multi-axis operations.</p> <p>RoboNet Reduce wiring and installation headaches with RoboNet. Operate via field network and connect up to 16 axes and register up to 768 points in Positioner mode and Simple Direct Value Mode. There is no limit on the number of positioning points when in Direct Numeric Value Mode. DIN rail installation means that the controller can be fastened and removed with ease.</p>	<p>P CON</p>  <p>PCON-C/CG PCON-CY PCON-PL/PO PCON-SE PCON-CF (High Output)</p> <p>ROBO NET</p>  <p>RPCON</p>	<p>A CON</p>  <p>ACON-C/CG ACON-CY ACON-PL/PO ACON-SE</p> <p>ROBO NET</p>  <p>RACON</p>	<p>S CON</p>  <p>SCON-C</p>
Program controller	<p>P SEL</p>   <p>1-axis type 2-axis type</p> <p>PSEL-C</p>	<p>A SEL</p>   <p>1-axis type 2-axis type</p> <p>ASEL-C</p>	<p>X-SEL</p>  <p>S SEL</p>   <p>1-axis type 2-axis type</p> <p>SSEL-C</p>
	<p>* Refer to ROBO Cylinder General Catalog for more info</p>		

Mounting

Various Mounting Methods

Mounting

ENERGY EFFICIENT ROBO Cylinder RCA/RCS2 actuators are available with optional MOUNTING BRACKETS similar to those normally used with air cylinders, such as the foot, TRUNNION and clevis. The rod tip accepts a knuckle joint, floating joint or other mounting brackets, so you can quickly and **COST-EFFECTIVELY** convert your existing air cylinder to a ROBO Cylinder to maximize ROI.

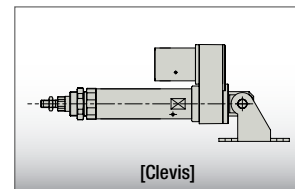
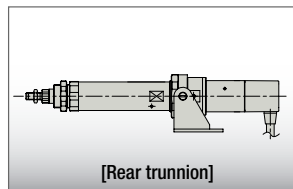
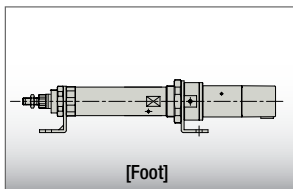
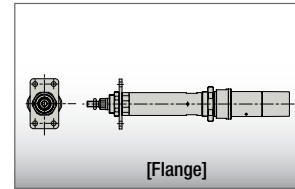
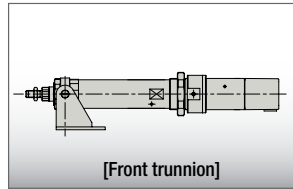
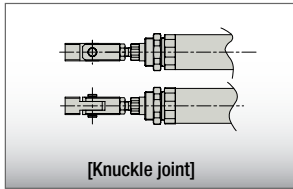

Application Examples

Want to replace an existing air cylinder without hassle

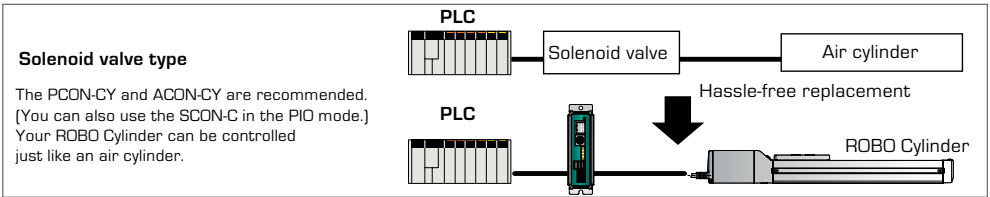

Want to connect to CC-Link and DeviceNet

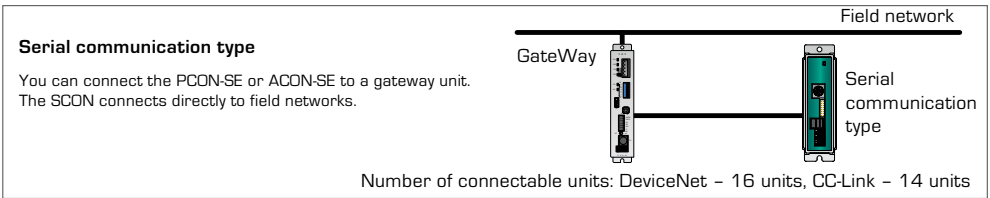

Want to operate it using a PLC based on pulse trains

Pulse-train input type
You can use the PCON-PL/PO, ACON-PL/PO or SCON-C.

Want to operate two axes

The PSEL, ASEL and SSEL have two-axis types. They can perform synchronized operation and interpolation operation.

Want to install it based on clevis/trunnion mount

Select either the rod-type RA3 or RA4 in the RCA/RCS2 series.