

ISDA/ISPDA ISDACR/ISPDACR

Cleanroom Type / Dust-proof Type

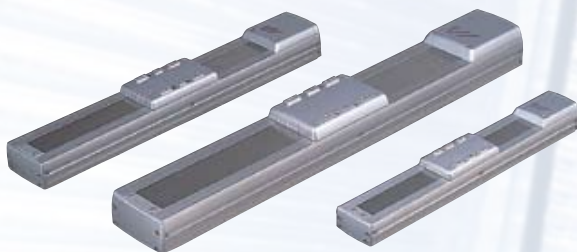

Cleanroom Type



Dust-proof Type

Significantly
improved maintainability
and acceleration
Cleanroom specification with a
maximum stroke of 2500 mm

1. Increased maximum acceleration of 1G (9800 mm/sec²)

As with the ISA Series, you can now set a maximum acceleration/deceleration of up to 1 G.

2. New dust-proof type and cleanroom type

The new dust-proof type and cleanroom type both adopt a protective barrier made of stainless steel strips.

3. Cleanroom type with a long maximum stroke of 2500 mm

The improvement of the mid-support mechanism and stainless steel strip results in a long maximum stroke of 2500mm.

4. All models now adopt coupling specification

The motor/ball screw assembly was changed to an easy maintenance coupling connection; all without changing the overall length. This allows easy replacement in the event of motor failure.

Model

Example of Use

Simple Dust-proof Type

ISDA - M - A - 200 - 20 - 500 - T1 - M - B

Series ISDA: Standard specification ISPDA: High-precision specification	Encoder type A: Absolute I: Incremental	Motor 60: 60W 100: 100W 200: 200W 400: 400W	Lead (mm) 4: 4mm 5: 5mm 8: 8mm 10: 10mm 16: 16mm 20: 20mm * The selectable leads vary depending on the model.	Applicable controller T1: XSEL-J/K E - Con P - Driver T2: XSEL-P/Q	Options AQ: AQ seal B: Brake NM: Reversed home specification RT: Guide with ball-retaining mechanism
Type S: Actuator width 94mm M: Actuator width 125mm MX: Actuator width 125mm Mid-support type L: Actuator width 155mm LX: Actuator width 155mm Mid-support type			Stroke (mm) 100 - 1600 * The stroke range varies depending on the model.	Cable length N: No cable S: 3m M: 5m X[]: Specified length * The standard cable is a robot cable.	

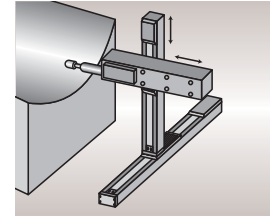

Simple dust-proof type (ISDA/ISPDA)
[For deburring applications]

Cleanroom Type

ISDACR - M - A - 200 - 20 - 500 - T1 - M - RT

Series ISDACR: Standard specification ISPDACR: High-precision specification	Encoder type A: Absolute I: Incremental	Motor 60: 60W 100: 100W 200: 200W 400: 400W	Lead (mm) 4: 4mm 5: 5mm 8: 8mm 10: 10mm 16: 16mm 20: 20mm * The selectable leads vary depending on the model.	Applicable controller T1: XSEL-J/K E - Con P - Driver T2: XSEL-P/Q	Options AQ: AQ seal B: Brake ESD: Anti-electrostatic specification NM: Reversed home specification RT: Guide with ball-retaining mechanism VR: Suction duct joint on opposite side
Type S: Actuator width 94mm M: Actuator width 125mm MX: Actuator width 125mm Mid-support type L: Actuator width 155mm LX: Actuator width 155mm Mid-support type			Stroke (mm) 100 - 2500 * The stroke range varies depending on the model.	Cable length N: No cable S: 3m M: 5m X[]: Specified length * The standard cable is a robot cable.	

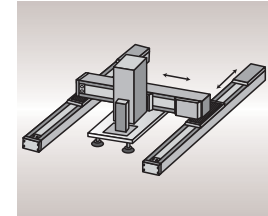

Cleanroom type (ISDACR/ISPDACR)
[For transferring glass substrates]

Specification Table

Type	Stroke (mm) and maximum speed (mm/sec) (Note 1)																Load capacity (Note 2)		Motor capacity (w)	Lead (mm)	Model
	100 - 500	600	700	800	900	1000	1100	1200	1300	1400	1500	1600	1700 - 2000	2100 - 2500	Horizontal (kg)	Vertical (kg)					
Simple dust-proof type	800	760													12	3	60	16	IS(P)DA-S-[]-60-16-[]-[]		
	400	380													25	6		8	IS(P)DA-S-[]-60-8-[]-[]		
	200	190													50	14		4	IS(P)DA-S-[]-60-4-[]-[]		
															20	3.5	100	20	IS(P)DA-M-[]-100-20-[]-[]		
	1000	915	735	600	500										40	9		10	IS(P)DA-M-[]-100-10-[]-[]		
	500	455	365	300	250										80	19		5	IS(P)DA-M-[]-100-5-[]-[]		
															40	9	200	20	IS(P)DA-M-[]-200-20-[]-[]		
	250	225	180	150	125										80	19		10	IS(P)DA-M-[]-200-10-[]-[]		
	1000	915	735	600	500										40	9		20	IS(P)DA-M-[]-200-10-[]-[]		
															80	19		10	IS(P)DA-M-[]-200-10-[]-[]		
															40	-	200	20	IS(P)DA-MX-[]-200-20-[]-[]		
															40	9		20	IS(P)DA-L-[]-200-20-[]-[]		
															80	19		10	IS(P)DA-L-[]-200-10-[]-[]		
															80	19	400	20	IS(P)DA-L-[]-400-20-[]-[]		
														40	-	200		20	IS(P)DA-LX-[]-200-20-[]-[]		
														80	-	400		20	IS(P)DA-LX-[]-400-20-[]-[]		
Cleanroom type	800	760													12	3	60	16	IS(P)DACR-S-[]-60-16-[]-[]		
	400	380													25	6		8	IS(P)DACR-S-[]-60-8-[]-[]		
	200	190													50	14		4	IS(P)DACR-S-[]-60-4-[]-[]		
															20	3.5	100	20	IS(P)DACR-M-[]-100-20-[]-[]		
	1000	915	735	600	500										40	9		10	IS(P)DACR-M-[]-100-10-[]-[]		
	500	455	365	300	250										80	19		5	IS(P)DACR-M-[]-100-5-[]-[]		
															40	9	200	20	IS(P)DACR-M-[]-200-20-[]-[]		
	250	225	180	150	125										80	19		10	IS(P)DACR-M-[]-200-10-[]-[]		
	1000	915	735	600	500										40	9		20	IS(P)DACR-M-[]-200-10-[]-[]		
															80	19		10	IS(P)DACR-M-[]-200-10-[]-[]		
															40	-	200	20	IS(P)DACR-MX-[]-200-20-[]-[]		
															40	9		20	IS(P)DACR-L-[]-200-20-[]-[]		
															80	19		10	IS(P)DACR-L-[]-200-10-[]-[]		
															80	19	400	20	IS(P)DACR-L-[]-400-20-[]-[]		
														40	-	200		20	IS(P)DACR-LX-[]-200-20-[]-[]		
														80	-	400		20	IS(P)DACR-LX-[]-400-20-[]-[]		

ISDA-S Single-Axis Robot: Compact Dust-proof Type, Actuator Width 94mm, 60W Straight Shape

ISPDA-S Single-Axis Robot: Compact Dust-proof Type, Actuator Width 94mm, 60W Straight Shape, High-Precision Specification

Type/Compact dust-proof (94 mm wide) Stroke/100-600mm Load capacity/50kg (horizontal)/14kg (vertical)

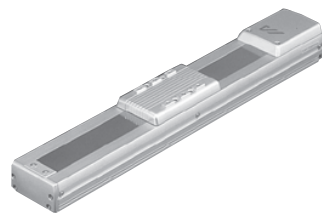

Model specification items Series Type Encoder type Motor output Lead Stroke Applicable controller Cable length Options
 (Example) ISDA - S - A - 60 - 16 - 600 - T1 - S - B

* Refer to page 1 for the details of model specification items.

Model/Specifications

Model	Encoder Type	Motor output (W)	Lead (mm)	Stroke 50mm increments (mm)	Speed (mm/s) (Note 1)	Load capacity (Note2)				Rated thrust (N)	Positioning repeatability (mm) (Note 3)
						Horizontal (kg)		Vertical (kg)			
						Rated acceleration	Maximum acceleration	Rated acceleration	Maximum acceleration		
ISDA [ISPDA]-S- [1] -60-16- [2] - [3] - [4] -[5]	Absolute	60	16	100 ~ 600	1 ~ 800	12	3.5	3	2	63.7	±0.02 [±0.01]
ISDA [ISPDA]-S- [1] -60-8- [2] - [3] - [4] - [5]	Incremental		8		1 ~ 400	25	12	6	5	127.4	
ISDA [ISPDA]-S- [1]-60 -4- [2] - [3] - [4] - [5]			4		1 ~ 200	50	30	14	12	254.8	

* In the above model names, [1] indicates the encoder type, [2] the stroke, [3] the applicable controller, [4] the cable length, and [5] the applicable options.

Options

Name	Code	Page	Remarks
AQ seal	AQ	·P18	
Brake	B	·P18	
Reversed home specification	NM	·P18	
Guide with ball-retaining mechanism	RT	·P18	

Common Specifications

Drive system (Note 4)	Ball screw ø12mm, rolled C10 [equivalent to rolled C5]
Backlash (Note 5)	0.05mm or less [0.02mm or less]
Guide	Integrated with base
Allowable load moment	Ma: 28.4N • m, Mb: 40.2N • m, Mc: 65.7N • m
Overhang load length	Ma/Mb/Mc directions: 450mm or less
Base	Material: Special aluminum with white alumite treatment
Applicable controller	T1: XSEL-J/K, E-Con, P-Driver; T2: XSEL-P/Q
Cable length (Note 6)	S: 3m, M: 5m, X□□: Length specification
Ambient operating temperature/humidity	0~40°C, 85%RH (non-condensing)

Dimensions

* Note that changing the home direction will require the actuator to be returned to IA1 for adjustment.

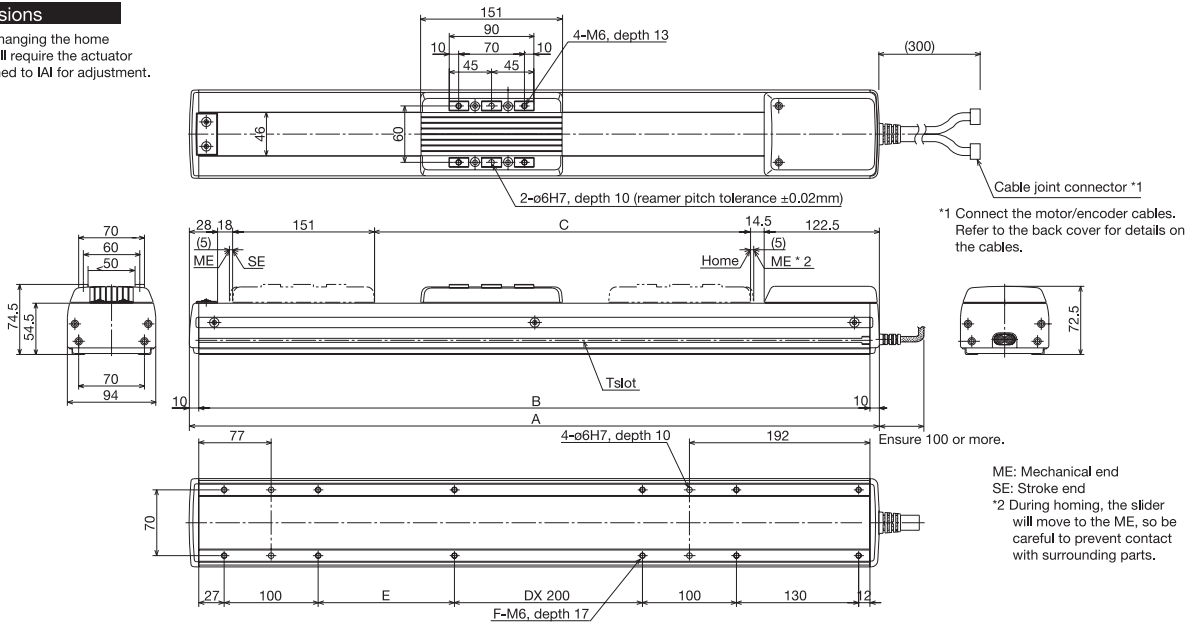

*1 Connect the motor/encoder cables. Refer to the back cover for details on the cables.

ME: Mechanical end
 SE: Stroke end
 *2 During homing, the slider will move to the ME, so be careful to prevent contact with surrounding parts.

Brake type (optional)

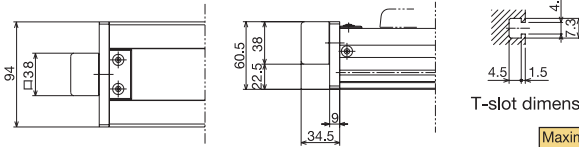

* Actuators with the brake are longer by 24.5 mm and heavier by 0.3 kg than their non-brake counterparts.

Stroke	100	150	200	250	300	350	400	450	500	550	600
A	434	484	534	584	634	684	734	784	834	884	934
B	414	464	514	564	614	664	714	764	814	864	914
C	100	150	200	250	300	350	400	450	500	550	600
D	-	-	-	-	1	1	1	1	2	2	2
E	45	95	145	195	45	95	145	195	45	95	145
F	10	10	10	10	12	12	12	12	14	14	14
Weight (kg)	3.8	4.1	4.4	4.7	5.1	5.4	5.7	6.0	6.3	6.6	7.0

Maximum speed (mm/s)	Lead 16	800	760
	Lead 8	400	380
	Lead 4	200	190

* Varies depending on the stroke.

Applicable Controller Specifications

Applicable controller	Maximum number of controlled axes	Compatible encoder type	Operating method	Supply voltage	Page
X-SEL-P/Q	6 axes	Absolute /incremental	Program	3-phase 200VAC	·Back cover
X-SEL-J/K	4 axes			Single-phase 100/200VAC	
E-Con	1 axis	Absolute /incremental	Positioner	AC100/AC200V	·Back cover
P-Driver	1 axis	Incremental	Pulse train	AC100/AC200V	·Back cover



(Note 1) When the stroke increases, the maximum speed drops in order to prevent the ball screw from reaching a dangerous speed. (Refer to the above table for the maximum speed at each stroke.)
 (Note 2) Refer to page 18 for the relationship of acceleration and load capacity.
 (Notes 3, 4, 5) The figures in [] apply to the ISPDA Series.
 (Note 6) The maximum cable length is 30 m. Specify a desired length in meters. (Example: X08 = 8 m)

ISDA-M-100

Single-Axis Robot: Medium Dust-proof Type, Actuator Width 125mm, 100W, Straight Shape

ISPDA-M-100

Single-Axis Robot: Medium Dust-proof Type, Actuator Width 125mm, 100W, Straight Shape, High-Precision Specification

Type / Medium dust-proof (125 mm wide) Stroke / 100~1000mm Load capacity / 80kg (horizontal)/19kg (vertical)

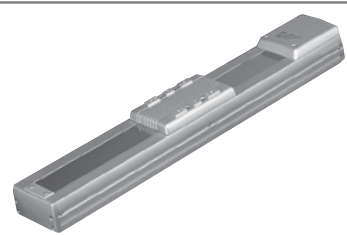

Model specification items Series Type Encoder type Motor output Lead Stroke Applicable controller Cable length Options
 (Example) ISDA - M - A - 100 - 20 - 1000 - T1 - S - B

* Refer to page 1 for the details of model specification items.

Model/Specifications

Model	Encoder Type	Motor output (W)	Lead (mm)	Stroke 50mm increments (mm)	Speed (mm/s) (Note 1)	Load capacity (Note2)				Rated thrust (N)	Positioning repeatability (mm) (Note 3)
						Horizontal (kg)		Vertical (kg)			
						Rated acceleration	Maximum acceleration	Rated acceleration	Maximum acceleration		
ISDA [ISPDA]-M-[1]-100-20-[2]-[3]-[4]-[5]	Absolute	100	20	100 ~ 1000	1 ~ 1000	20	6	3.5	2	84.3	±0.02 [±0.01]
ISDA [ISPDA]-M-[1]-100-10-[2]-[3]-[4]-[5]	Incremental		10		1 ~ 500	40	20	9	7	169.5	
ISDA [ISPDA]-M-[1]-100-5-[2]-[3]-[4]-[5]			5		1 ~ 250	80	45	19	15	340.1	

* In the above model names, [1] indicates the encoder type, [2] the stroke, [3] the applicable controller, [4] the cable length, and [5] the applicable options.

Options

Name	Code	Page	Remarks
AQ seal	AQ	•P18	
Brake	B	•P18	
Reversed home specification	NM	•P18	
Guide with ball-retaining mechanism	RT	•P18	

Common Specifications

Drive system (Note 4)	Ball screw ø16mm, rolled C10 [equivalent to rolled C5]
Backlash (Note 5)	0.05mm or less [0.02mm or less]
Guide	Integrated with base
Allowable load moment	Ma: 69.6N • m, Mb: 99.0N • m, Mc: 161.7N • m
Overhang load length	Ma/Mb/Mc directions: 600mm or less
Base	Material: Aluminum with white alumite treatment
Applicable controller	T1: XSEL-J/K, E-Con, P-Driver; T2: XSEL-P/Q
Cable length (Note 6)	S: 3m, M: 5m, X□□: Length specification
Ambient operating temperature/humidity	0~40°C, 85%RH (non-condensing)

Dimensions

* Note that changing the home direction will require the actuator to be returned to IAI for adjustment.

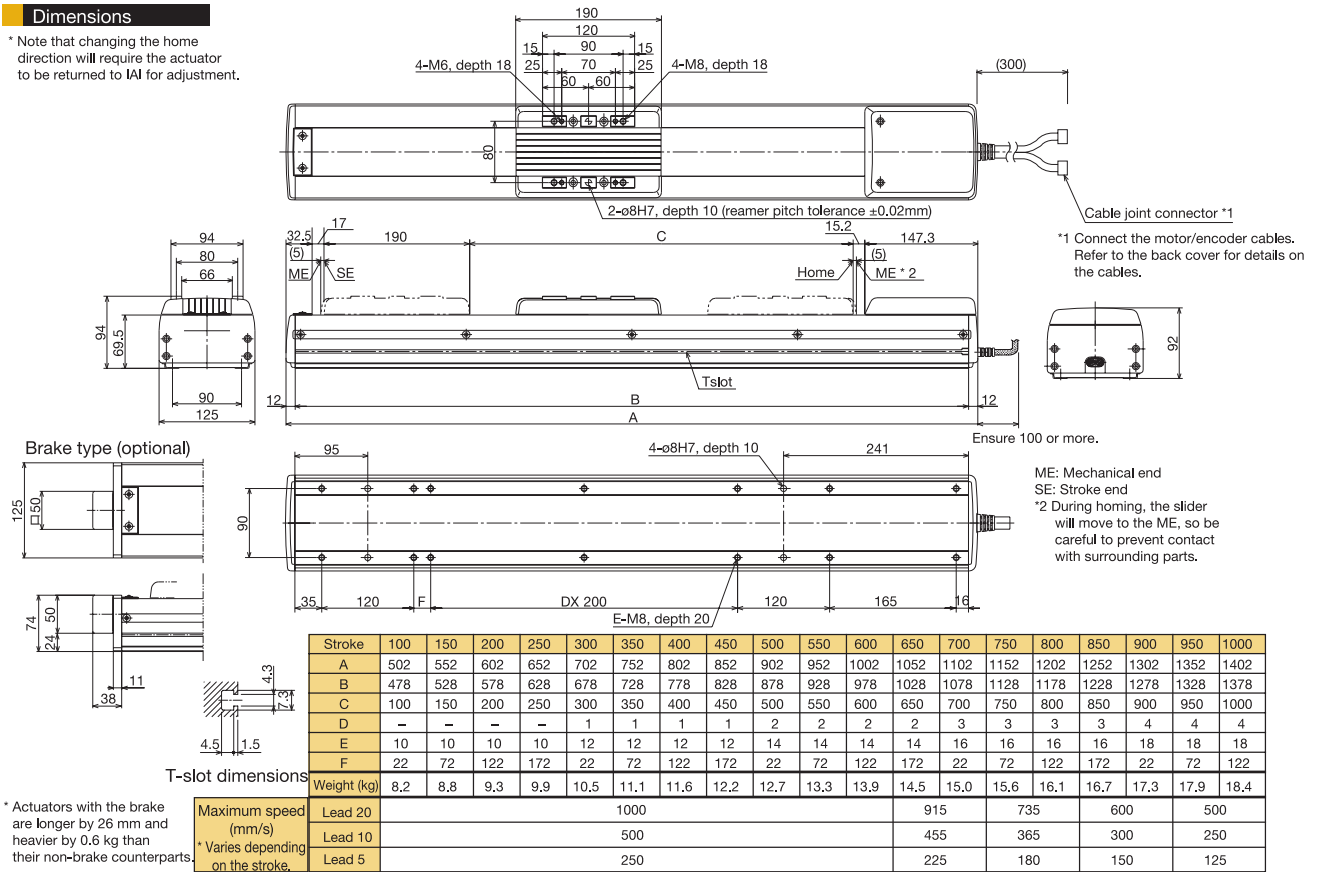

* Actuators with the brake are longer by 26 mm and heavier by 0.6 kg than their non-brake counterparts.

Applicable Controller Specifications

Applicable controller	Maximum number of controlled axes	Compatible encoder type	Operating method	Supply voltage	Page
X-SEL-P/Q	6 axes	Absolute / Incremental	Program	3-phase 200VAC	•Back cover
X-SEL-J/K	4 axes				
E-Con	1 axis	Absolute / Incremental	Positioner	AC100/AC200V	•Back cover
P-Driver	1 axis	Incremental	Pulse train	AC100/AC200V	•Back cover

Caution

(Note 1) When the stroke increases, the maximum speed drops in order to prevent the ball screw from reaching a dangerous speed. (Refer to the above table for the maximum speed at each stroke.)

(Note 2) Refer to page 18 for the relationship of acceleration and load capacity.

(Notes 3, 4, 5) The figures in [] apply to the ISPDA Series.

(Note 6) The maximum cable length is 30 m. Specify a desired length in meters. (Example: X08 = 8 m)

3

ISDA-M-200 Single-Axis Robot: Medium Dust-proof Type, Actuator Width 125mm, 200W, Straight Shape

ISPDA-M-200 Single-Axis Robot: Medium Dust-proof Type, Actuator Width 125mm, 200W, Straight Shape, High-Precision Specification

Type / Medium dust-proof (125 mm wide) Stroke / 100~1000mm Load capacity / 80kg (horizontal)/19kg (vertical)

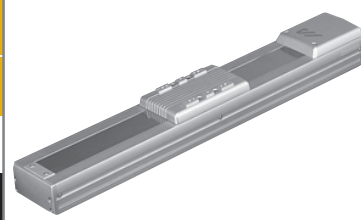

Model specification items Series Type Encoder type Motor output Lead Stroke Applicable controller Cable length Options
 (Example) ISDA - M - A - 200 - 20 - 1000 - T1 - S - B

* Refer to page 1 for the details of model specification items.

Model/Specifications

Model	Encoder Type	Motor output (W)	Lead (mm)	Stroke 50mm increments (mm)	Speed (mm/s) (Note 1)	Load capacity (Note2)				Rated thrust (N)	Positioning repeatability (mm) (Note 3)
						Horizontal (kg)		Vertical (kg)			
						Rated acceleration	Maximum acceleration	Rated acceleration	Maximum acceleration		
ISDA [ISPDA]-M- [1]-200-20- [2]- [3]- [4]- [5]	Absolute	200	20	100 ~ 1000	1 ~ 1000	40	12	9	5	169.5	±0.02
ISDA [ISPDA]-M- [1]-200-10- [2]- [3]- [4]- [5]	Incremental		10			80	40	19	15		

* In the above model names, [1] indicates the encoder type, [2] the stroke, [3] the applicable controller, [4] the cable length, and [5] the applicable options.

Options

Name	Code	Page	Remarks
AQ seal	AQ	·P18	
Brake	B	·P18	
Reversed home specification	NM	·P18	
Guide with ball-retaining mechanism	RT	·P18	

Common Specifications

Drive system (Note 4)	Ball screw ø16mm, rolled C10 [equivalent to rolled C5]
Backlash (Note 5)	0.05mm or less [0.02mm or less]
Guide	Integrated with base
Allowable load moment	Ma: 69.6N · m, Mb: 99.0N · m, Mc: 161.7N · m
Overhang load length	Ma/Mb/Mc directions: 600mm or less
Base	Material: Aluminum with white alumite treatment
Applicable controller	T1: XSEL-J/K, E-Con, P-Driver; T2: XSEL-P/Q
Cable length (Note 6)	S: 3m, M: 5m, X□□: Length specification
Ambient operating temperature/humidity	0~40°C, 85%RH (non-condensing)

Dimensions

* Note that changing the home direction will require the actuator to be returned to IAI for adjustment.

ME: Mechanical end
 SE: Stroke end
 *2 During homing, the slider will move to the ME, so be careful to prevent contact with surrounding parts.

Stroke	100	150	200	250	300	350	400	450	500	550	600	650	700	750	800	850	900	950	1000	
A	502	552	602	652	702	752	802	852	902	952	1002	1052	1102	1152	1202	1252	1302	1352	1402	
B	478	528	578	628	678	728	778	828	878	928	978	1028	1078	1128	1178	1228	1278	1328	1378	
C	100	150	200	250	300	350	400	450	500	550	600	650	700	750	800	850	900	950	1000	
D	-	-	-	-	1	1	1	1	2	2	2	2	3	3	3	3	4	4	4	
E	10	10	10	10	12	12	12	12	14	14	14	16	16	16	16	16	18	18	18	
F	22	72	122	172	22	72	122	172	22	72	122	172	22	72	122	172	22	72	122	
Weight (kg)	8.4	9.0	9.6	10.2	10.7	11.3	11.9	12.5	13.0	13.6	14.1	14.7	15.3	15.9	16.4	17.0	17.5	18.1	18.7	
Maximum speed (mm/s) * Varies depending on the stroke.	1000												915	735	600	500				
	500												455	365	300	250				

* Actuators with the brake are longer by 26 mm and heavier by 0.6 kg than T-slot dimensions their non-brake counterparts.

Applicable Controller Specifications

Applicable controller	Maximum number of controlled axes	Compatible encoder type	Operating method	Supply voltage	Page
X-SEL-P/Q	6 axes	Absolute /incremental	Program	3-phase 200VAC	Back cover
X-SEL-J/K	4 axes			Single-phase 100/200VAC	
E-Con	1 axis	Absolute /incremental	Positioner	AC100/AC200V	Back cover
P-Driver	1 axis	Incremental	Pulse train	AC100/AC200V	Back cover

Caution

(Note 1) When the stroke increases, the maximum speed drops in order to prevent the ball screw from reaching a dangerous speed. (Refer to the above table for the maximum speed at each stroke.)
 (Note 2) Refer to page 18 for the relationship of acceleration and load capacity.
 (Notes 3, 4, 5) The figures in [] apply to the ISPDA Series.
 (Note 6) The maximum cable length is 30 m. Specify a desired length in meters. (Example: X08 = 8 m)

ISDA-MX-200

Single-Axis Robot: Medium Dust-proof Mid-support Type, Actuator Width 125mm, 200W, Straight Shape

ISPDA-MX-200

Single-Axis Robot: Medium Dust-proof Mid-support Type, Actuator Width 125mm, 200W, Straight Shape, High-Precision Specification

Type	Medium dust-proof (125 mm wide) Mid-support Type	Stroke	800~1600mm	Load capacity	40kg (horizontal)
------	--	--------	------------	---------------	-------------------

Model specification items	Series	Type	Encoder type	Motor output	Lead	Stroke	Applicable controller	Cable length	Options
(Example)	ISDA	- MX -	A	- 200 -	20	- 1600 -	T1	- S -	B

* Refer to page 1 for the details of model specification items.

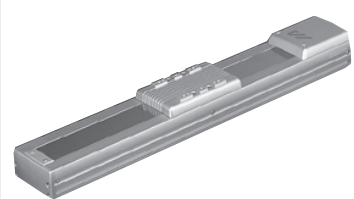

Model/Specifications

Model	Encoder Type	Motor output (W)	Lead (mm)	Stroke 100mm increments (mm)	Speed (mm/s) (Note 1)	Load capacity (Note2)				Rated thrust (N)	Positioning repeatability (mm) (Note 3)
						Horizontal (kg)		Vertical (kg)			
						Rated acceleration	Maximum acceleration	Rated acceleration	Maximum acceleration		
ISDA [ISPDA]-MX- [1] -200-20- [3] - [4] - [5]	Absolute Incremental	200	20	800 ~ 1600	1 ~ 1000	40	Horizontal only		169.5	±0.02 [±0.01]	

* In the above model names, [1] indicates the encoder type, [2] the stroke, [3] the applicable controller, [4] the cable length, and [5] the applicable options.

Options

Name	Code	Page	Remarks
AQ seal	AQ	·P18	
Brake	B	·P18	
Reversed home specification	NM	·P18	
Guide with ball-retaining mechanism	RT	·P18	

Common Specifications

Drive system (Note 4)	Ball screw ø16mm, rolled C10 [equivalent to rolled C5]
Backlash (Note 5)	0.05mm or less [0.02mm or less]
Guide	Integrated with base
Allowable load moment	Ma: 69.6N · m, Mb: 99.0N · m, Mc: 161.7N · m
Overhang load length	Ma/Mb/Mc directions: 600mm or less
Base	Material: Aluminum with white alumite treatment
Applicable controller	T1: XSEL-J/K, E-Con, P-Driver; T2: XSEL-P/Q
Cable length (Note 6)	S: 3m, M: 5m, X□□: Length specification
Ambient operating temperature/humidity	0~40°C, 85%RH (non-condensing)

Dimensions

* Note that changing the home direction will require the actuator to be returned to IA1 for adjustment.

* Due to their structure, the mid-support type cannot be positioned horizontally on their side, or in vertical direction.

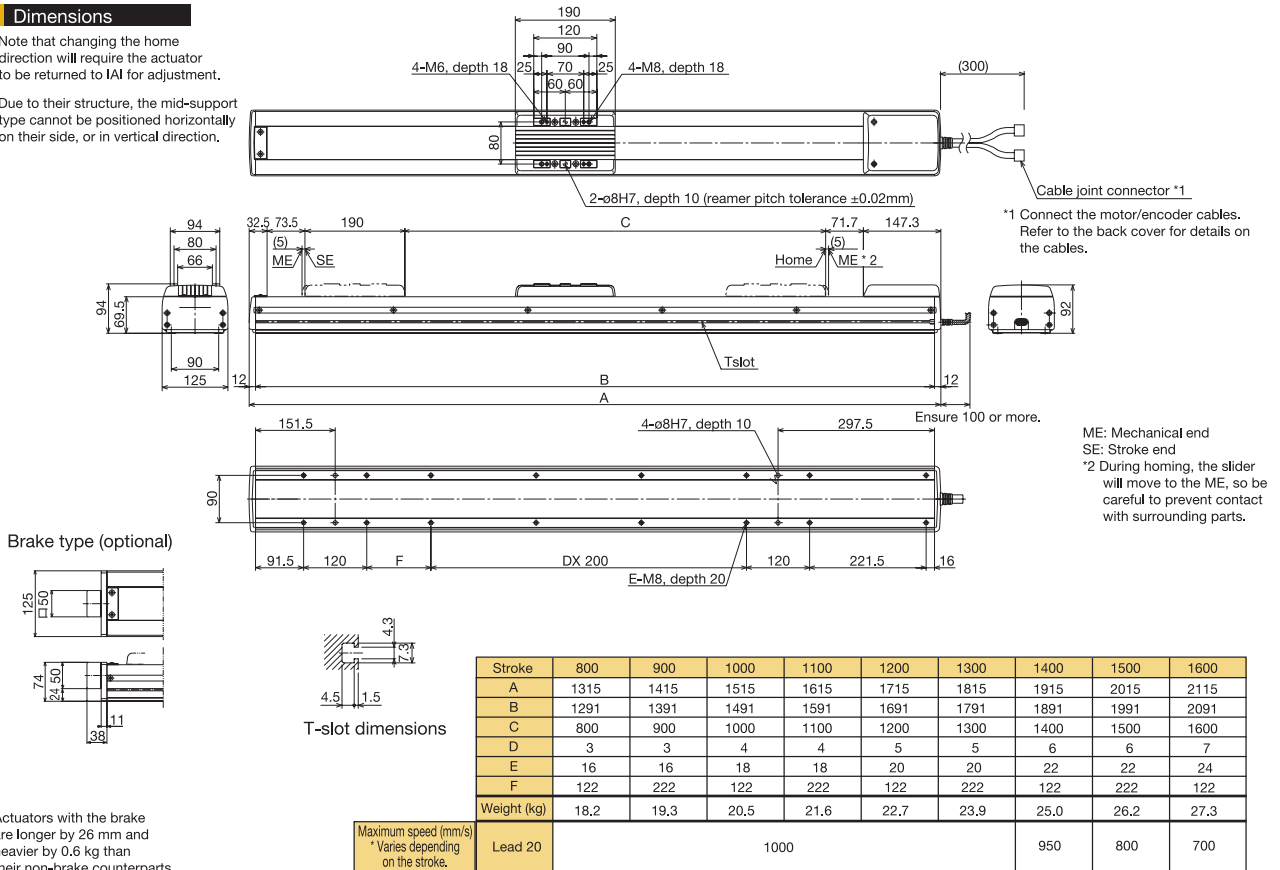

* Actuators with the brake are longer by 26 mm and heavier by 0.6 kg than their non-brake counterparts.

Applicable Controller Specifications

Applicable controller	Maximum number of controlled axes	Compatible encoder type	Operating method	Supply voltage	Page
X-SEL-P/Q	6 axes	Absolute /incremental	Program	3-phase 200VAC	·Back cover
X-SEL-J/K	4 axes				Single-phase 100/200VAC
E-Con	1 axis	Absolute /incremental	Positioner	AC100/AC200V	·Back cover
P-Driver	1 axis	Incremental	Pulse train	AC100/AC200V	·Back cover



(Note 1) When the stroke increases, the maximum speed drops in order to prevent the ball screw from reaching a dangerous speed. (Refer to the above table for the maximum speed at each stroke.)
 (Note 2) Refer to page 18 for the relationship of acceleration and load capacity.
 (Notes 3, 4, 5) The figures in [] apply to the ISPDA Series.
 (Note 6) The maximum cable length is 30 m. Specify a desired length in meters. (Example: X08 = 8 m)

5

ISDA-L-200

Single-Axis Robot: Large Dust-proof Type,
Actuator Width 155mm, 200W, Straight Shape

ISPDA-L-200

Single-Axis Robot: Large Dust-proof Type,
Actuator Width 155mm, 200W, Straight Shape, High-Precision Specification

Type / Large dust-proof (155 mm wide) Stroke / 100~1200mm Load capacity / 80kg (horizontal)/19kg (vertical)

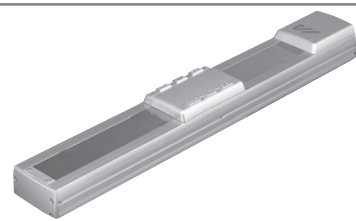

Model specification items Series Type Encoder type Motor output Lead Stroke Applicable controller Cable length Options
(Example) ISDA - L - A - 200 - 20 - 1200 - T1 - S - B

* Refer to page 1 for the details of model specification items.

Model/Specifications

Model	Encoder Type	Motor output (W)	Lead (mm)	Stroke 50mm increments (mm)	Speed (mm/s) (Note 1)	Load capacity (Note2)				Rated thrust (N)	Positioning repeatability (mm) (Note 3)
						Horizontal (kg)		Vertical (kg)			
						Rated acceleration	Maximum acceleration	Rated acceleration	Maximum acceleration		
ISDA [ISPDA]-L- [1] -200-20- [2] - [3] - [4] - [5]	Absolute	200	20	100 ~ 1200	1 ~ 1000	40	12	9	4	169.5	±0.02
ISDA [ISPDA]-L- [1] -200-10- [2] - [3] - [4] - [5]	Incremental		10		1 ~ 500	80	40	19	14	340.1	[±0.01]

* In the above model names, [1] indicates the encoder type, [2] the stroke, [3] the applicable controller, [4] the cable length, and [5] the applicable options.

Options

Name	Code	Page	Remarks
AQ seal	AQ	·P18	
Brake	B	·P18	
Reversed home specification	NM	·P18	
Guide with ball-retaining mechanism	RT	·P18	

Common Specifications

Drive system (Note 4)	Ball screw ø20mm, rolled C10 [equivalent to rolled C5]
Backlash (Note 5)	0.05mm or less [0.02mm or less]
Guide	Integrated with base
Allowable load moment	Ma: 104.9N • m, Mb: 149.9N • m, Mc: 248.9N • m
Overhang load length	Ma/Mb/Mc directions: 750mm or less
Base	Material: Aluminum with white alumite treatment
Applicable controller	T1: XSEL-J/K, E-Con, P-Driver; T2: XSEL-P/Q
Cable length (Note 6)	S: 3m, M: 5m, X□□: Length specification
Ambient operating temperature/humidity	0~40°C, 85%RH (non-condensing)

Dimensions

* Note that changing the home direction will require the actuator to be returned to IAI for adjustment.

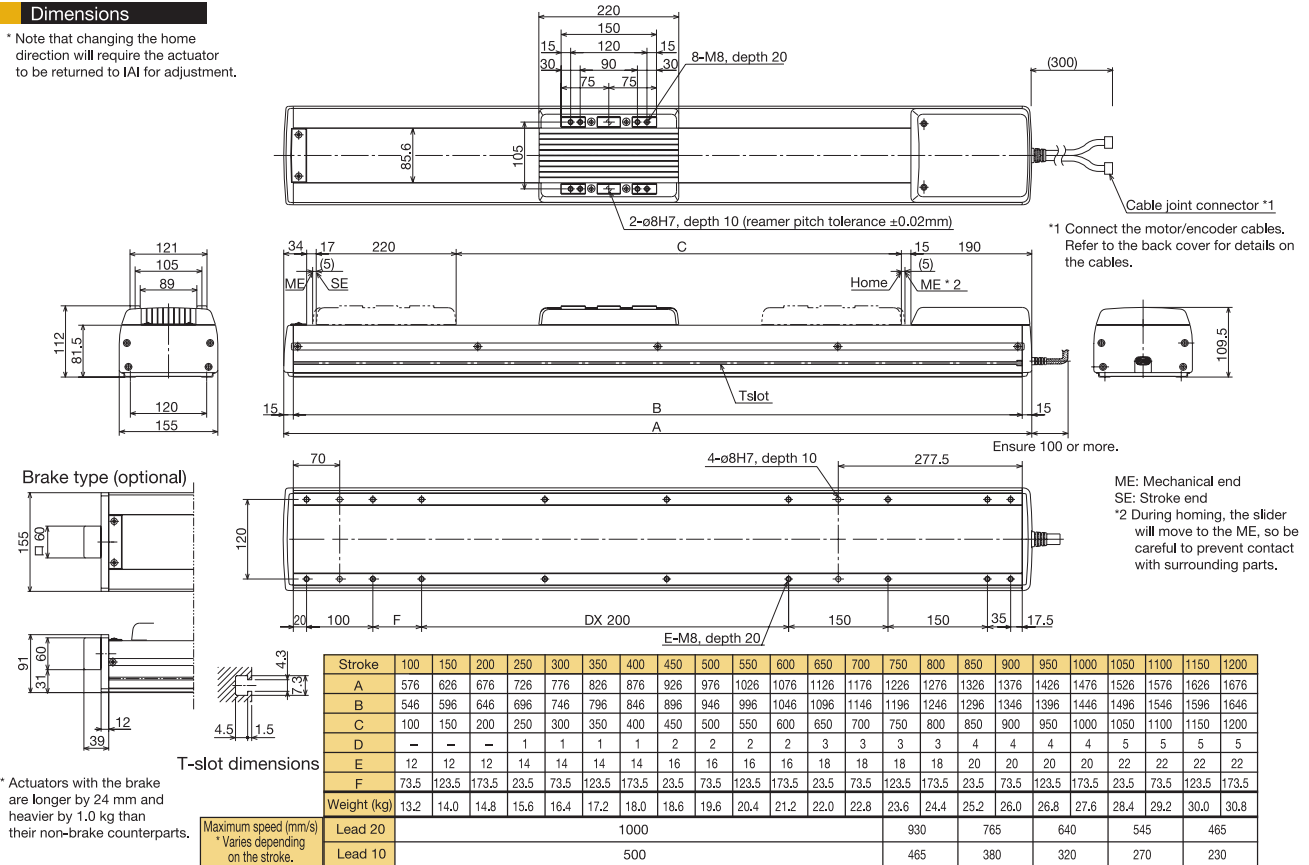

* Actuators with the brake are longer by 24 mm and heavier by 1.0 kg than their non-brake counterparts.

Applicable Controller Specifications

Applicable controller	Maximum number of controlled axes	Compatible encoder type	Operating method	Supply voltage	Page
X-SEL-P/Q	6 axes	Absolute /incremental	Program	3-phase 200VAC	Back cover
X-SEL-J/K	4 axes			Single-phase 100/200VAC	
E-Con	1 axis	Absolute /incremental	Positioner	AC100V/AC200V	Back cover
P-Driver	1 axis	Incremental	Pulse train	AC100V/AC200V	Back cover



(Note 1) When the stroke increases, the maximum speed drops in order to prevent the ball screw from reaching a dangerous speed. (Refer to the above table for the maximum speed at each stroke.)
(Note 2) Refer to page 18 for the relationship of acceleration and load capacity.
(Notes 3, 4, 5) The figures in [] apply to the ISPDA Series.
(Note 6) The maximum cable length is 30 m. Specify a desired length in meters. (Example: X08 = 8 m)

ISDA-L-400

Single-Axis Robot: Large Dust-proof Mid-support Type, Actuator Width 155mm, 400W, Straight Shape

ISPDA-L-400

Single-Axis Robot: Large Dust-proof Mid-support Type, Actuator Width 155mm, 400W, Straight Shape, High-Precision Specification

Type Large dust-proof (155 mm wide) Stroke 100~1200mm Load capacity 80kg (horizontal)/19kg (vertical)

Model specification items Series Type Encoder type Motor output Lead Stroke Applicable controller Cable length Options

(Example) ISDA - L - A - 400 - 20 - 1200 - T1 - S - B

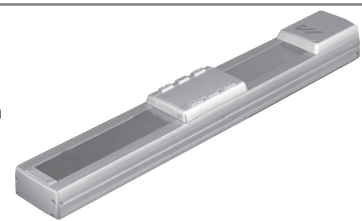

Model/Specifications

Model	Encoder Type	Motor output (W)	Lead (mm)	Stroke 50mm increments (mm)	Speed (mm/s) (Note 1)	Load capacity (Note2)				Rated thrust (N)	Positioning repeatability (mm) (Note 3)
						Horizontal (kg)		Vertical (kg)			
						Rated acceleration	Maximum acceleration	Rated acceleration	Maximum acceleration		
ISDA [ISPDA]-L-[1]-400-20-[2]-[3]-[4]-[5]	Absolute Incremental	400	20	100 ~ 1200	1 ~ 1000	80	24	19	10	340.1	±0.02 [±0.01]

*In the above model names, [1] indicates the encoder type, [2] the stroke, [3] the applicable controller, [4] the cable length, and [5] the applicable options.

Options

Name	Code	Page	Remarks
AQ seal	AQ	•P18	
Brake	B	•P18	
Reverse home specification	NM	•P18	
Guide with ball-retaining mechanism	RT	•P18	

Common Specifications

Drive system (Note 4)	Ball screw ø20mm, rolled C10 [equivalent to rolled C5]
Backlash (Note 5)	0.05mm or less [0.02mm or less]
Guide	Integrated with base
Allowable load moment	Ma: 104.9N • m, Mb: 149.9N • m, Mc: 248.9N • m
Overhang load length	Ma/Mb/Mc directions: 750mm or less
Base	Material: Aluminum with white alumite treatment
Applicable controller	T1: XSEL-J/K, E-Con, P-Driver; T2: XSEL-P/Q
Cable length (Note 6)	S: 3m, M: 5m, X□□: Length specification
Ambient operating temperature/humidity	0~40°C, 85%RH (non-condensing)

Dimensions

* Note that changing the home direction will require the actuator to be returned to IAI for adjustment.

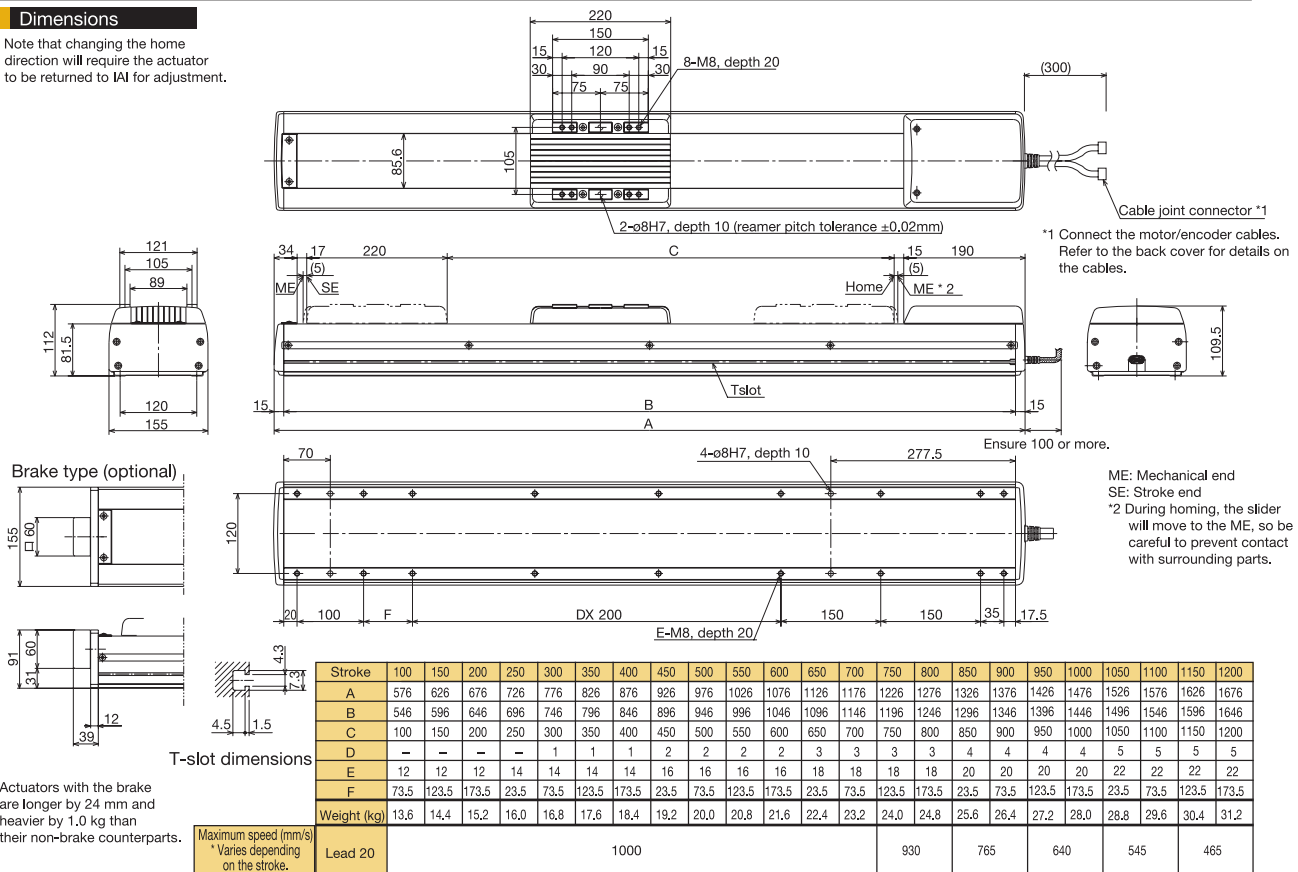

* Actuators with the brake are longer by 24 mm and heavier by 1.0 kg than their non-brake counterparts.

Maximum speed (mm/s)
* Varies depending on the stroke.

Applicable Controller Specifications

Applicable controller	Maximum number of controlled axes	Compatible encoder type	Operating method	Supply voltage	Page
X-SEL-P/Q	6 axes	Absolute / Incremental	Program	3-phase 200VAC	Back cover
X-SEL-J/K	4 axes				
E-Con	1 axis	Absolute / Incremental	Positioner	AC100/AC200V	Back cover
P-Driver	1 axis	Incremental	Pulse train	AC100/AC200V	Back cover

Caution

(Note 1) When the stroke increases, the maximum speed drops in order to prevent the ball screw from reaching a dangerous speed. (Refer to the above table for the maximum speed at each stroke.)

(Note 2) Refer to page 18 for the relationship of acceleration and load capacity.

(Notes 3, 4, 5) The figures in [] apply to the ISPDA Series.

(Note 6) The maximum cable length is 30 m. Specify a desired length in meters. (Example: X08 = 8 m)

7

ISDA-LX-200

Single-Axis Robot: Large Dust-proof Mid-support Type, Actuator Width 155mm, 200W, Straight Shape

ISPDA-LX-200

Single-Axis Robot: Large Dust-proof Mid-support Type, Actuator Width 155mm, 200W, Straight Shape, High-Precision Specification

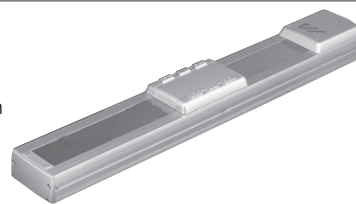

Type	Large dust-proof (155 mm wide) Mid-support Type	Stroke	1000-1600mm	Load capacity	40kg (horizontal)
------	---	--------	-------------	---------------	-------------------

Model specification items Series Type Encoder type Motor output Lead Stroke Applicable controller Cable length Options
 (Example) ISDA - LX - A - 200 - 20 - 1600 - T1 - S - B

* Refer to page 1 for the details of model specification items.

Model/Specifications

Model	Encoder Type	Motor output (W)	Lead (mm)	Stroke 100mm increments (mm)	Speed (mm/s) (Note 1)	Load capacity (Note2)				Rated thrust (N)	Positioning repeatability (mm) (Note 3)
						Horizontal (kg)		Vertical (kg)			
						Rated acceleration	Maximum acceleration	Rated acceleration	Maximum acceleration		
ISDA /ISPDA-LX-[1]-200-20-[2]-[3]-[4]-[5]	Absolute Incremental	200	20	1000 - 1600	1 ~ 1000	40	Horizontal only		169.5	±0.02 [±0.01]	

* In the above model names, [1] indicates the encoder type, [2] the stroke, [3] the applicable controller, [4] the cable length, and [5] the applicable options.

Options

Name	Code	Page	Remarks
AQ seal	AQ	·P18	
Brake	B	·P18	
Reversed home specification	NM	·P18	
Guide with ball-retaining mechanism	RT	·P18	

Common Specifications

Drive system (Note 4)	Ball screw ø20mm, rolled C10 [equivalent to rolled C5]
Backlash (Note 5)	0.05mm or less [0.02mm or less]
Guide	Integrated with base
Allowable load moment	Ma: 104.9N · m, Mb: 149.9N · m, Mc: 248.9N · m
Overhang load length	Ma/Mb/Mc directions: 750mm or less
Base	Material: Aluminum with white alumite treatment
Applicable controller	T1: XSEL-J/K, E-Con, P-Driver; T2: XSEL-P/Q
Cable length (Note 6)	S: 3m, M: 5m, X□□: Length specification
Ambient operating temperature/humidity	0~40°C, 85%RH (non-condensing)

Dimensions

* Note that changing the home direction will require the actuator to be returned to IAI for adjustment.

* Due to their structure, the mid-support type cannot be positioned horizontally on their side, or in vertical direction.

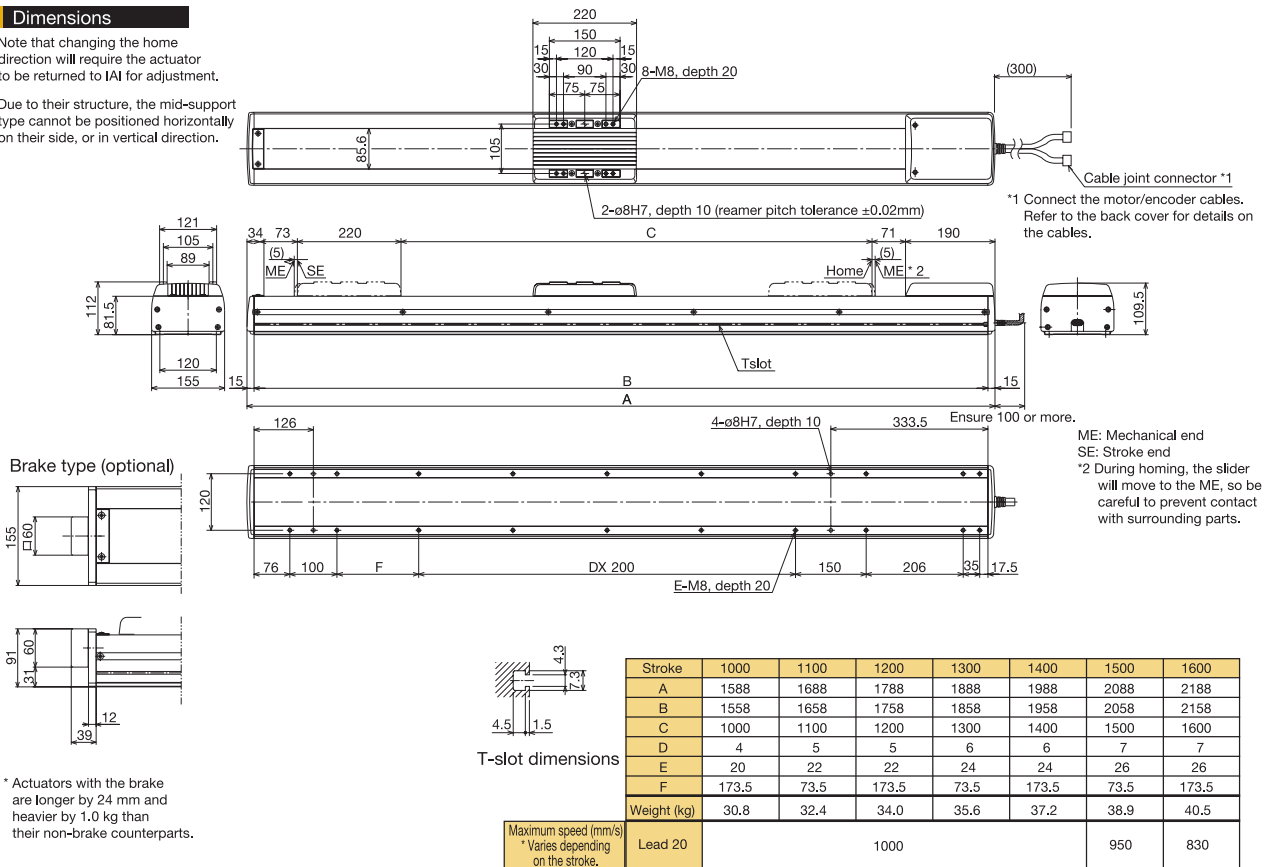

Brake type (optional)

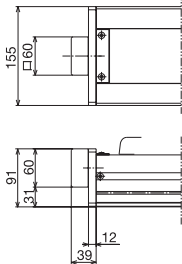

* Actuators with the brake are longer by 24 mm and heavier by 1.0 kg than their non-brake counterparts.

T-slot dimensions



Applicable Controller Specifications

Applicable controller	Maximum number of controlled axes	Compatible encoder type	Operating method	Supply voltage	Page
X-SEL-P/Q	6 axes	Absolute /incremental	Program	3-phase 200VAC	Back cover
X-SEL-J/K	4 axes			Single-phase 100/200VAC	
E-Con	1 axis	Absolute /incremental	Positioner	AC100/AC200V	Back cover
P-Driver	1 axis	Incremental	Pulse train	AC100/AC200V	Back cover



(Note 1) When the stroke increases, the maximum speed drops in order to prevent the ball screw from reaching a dangerous speed. (Refer to the above table for the maximum speed at each stroke.)
 (Note 2) Refer to page 18 for the relationship of acceleration and load capacity.
 (Notes 3, 4, 5) The figures in [] apply to the ISPDA Series.
 (Note 6) The maximum cable length is 30 m. Specify a desired length in meters. (Example: X08 = 8 m)

ISDA-LX-400

Single-Axis Robot: Large Dust-proof Mid-support Type, Actuator Width 155mm, 400W, Straight Shape

ISPDA-LX-400

Single-Axis Robot: Large Dust-proof Mid-support Type, Actuator Width 155mm, 400W, Straight Shape, High-Precision Specification

Type	Large dust-proof (155 mm wide) Mid-support Type	Stroke	1000-1600mm	Load capacity	80kg (horizontal)
------	---	--------	-------------	---------------	-------------------

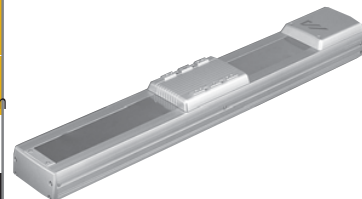

Model specification items	Series	Type	Encoder type	Motor output	Lead	Stroke	Applicable controller	Cable length	Options
(Example)	ISDA	LX	A	400	20	1600	T1	S	B

* Refer to page 1 for the details of model specification items.

Model/Specifications

Model	Encoder Type	Motor output (W)	Lead (mm)	Stroke 100mm increments (mm)	Speed (mm/s) (Note 1)	Load capacity (Note 2)		Rated thrust (N)	Positioning repeatability (mm) (Note 3)
						Horizontal (kg)	Vertical (kg)		
ISDA [ISPDA]-LX-[1]-400-[2]-[3]-[4]-[5]	Absolute Incremental	400	20	1000 ~ 1600	1 ~ 1000	80	Horizontal only	340.1	±0.02 [±0.01]

* In the above model names, [1] indicates the encoder type, [2] the stroke, [3] the applicable controller, [4] the cable length, and [5] the applicable options.

Options

Name	Code	Page	Remarks
AQ seal	AQ	·P18	
Brake	B	·P18	
Reversed home specification	NM	·P18	
Guide with ball-retaining mechanism	RT	·P18	

Common Specifications

Drive system (Note 4)	Ball screw ø20mm, rolled C10 [equivalent to rolled C5]
Backlash (Note 5)	0.05mm or less [0.02mm or less]
Guide	Integrated with base
Allowable load moment	Ma: 104.9N · m, Mb: 149.9N · m, Mc: 248.9N · m
Overhang load length	Ma/Mb/Mc directions: 750mm or less
Base	Material: Aluminum with white alumite treatment
Applicable controller	T1: XSEL-J/K, E-Con, P-Driver; T2: XSEL-P/Q
Cable length (Note 6)	S: 3m, M: 5m, X□□: Length specification
Ambient operating temperature/humidity	0~40°C, 85%RH (non-condensing)

Dimensions

* Note that changing the home direction will require the actuator to be returned to IA for adjustment.

* Due to their structure, the mid-support type cannot be positioned horizontally on their side, or in vertical direction.

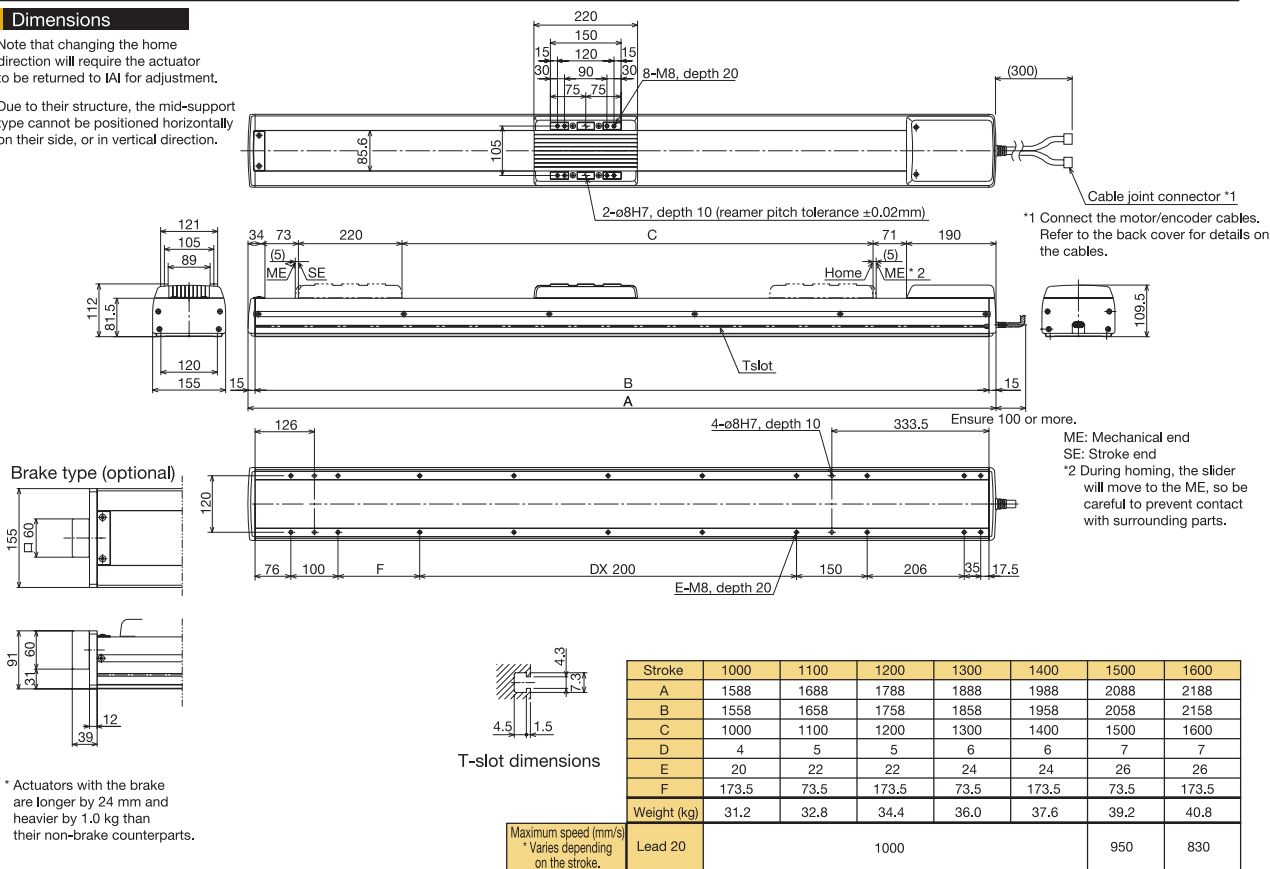

* Actuators with the brake are longer by 24 mm and heavier by 1.0 kg than their non-brake counterparts.

Applicable Controller Specifications

Applicable controller	Maximum number of controlled axes	Compatible encoder type	Operating method	Supply voltage	Page
X-SEL-P/Q	6 axes	Absolute /incremental	Program	3-phase 200VAC	·Back cover
X-SEL-J/K	4 axes			Single-phase 100/200VAC	
E-Con	1 axis	Absolute /incremental	Positioner	AC100/AC200V	·Back cover
P-Driver	1 axis	Incremental	Pulse train	AC100/AC200V	·Back cover



(Note 1) When the stroke increases, the maximum speed drops in order to prevent the ball screw from reaching a dangerous speed. (Refer to the above table for the maximum speed at each stroke.)
 (Note 2) Refer to page 18 for the relationship of acceleration and load capacity.
 (Notes 3, 4, 5) The figures in [] apply to the ISPDA Series.
 (Note 6) The maximum cable length is 30 m. Specify a desired length in meters. (Example: X08 = 8 m)

ISDACR-S

Single-Axis Robot: Compact Cleanroom Type
Actuator Width 94mm, 60W, Straight Shape

ISPDACR-S

Single-Axis Robot: Compact Cleanroom Type
Actuator Width 94mm, 60W, Straight Shape, High-Precision Specification

Type/Compact (94 mm wide)

Stroke/100-600mm

Load capacity/50kg (horizontal)/14kg (vertical)



Model specification items Series Type Encoder type Motor output Lead Stroke Applicable controller Cable length Options

(Example) ISDACR - S - A - 60 - 16 - 600 - T1 - S - B

* Refer to page 1 for the details of model specification items.

Model/Specifications

Model	Encoder Type	Motor output (W)	Lead (mm)	Stroke 50mm increments (mm)	Speed (mm/s) (Note 1)	Load capacity (Note 2)				Rated thrust (N)	Positioning repeatability (mm) (Note 3)	Suction rate (Nl/min)
						Horizontal (kg)		Vertical (kg)				
						Rated acceleration	Maximum acceleration	Rated acceleration	Maximum acceleration			
ISDACR [ISPDACR]-S-[1]-60-16-[2]-[3]-[4]-[5]	Absolute	60	16	100 ~ 600	1 ~ 800	12	3.5	3	2	63.7	±0.02 [±0.01]	30
ISDACR [ISPDACR]-S-[1]-60-8-[2]-[3]-[4]-[5]	Incremental		8		1 ~ 400	25	12	6	5	127.4		20
ISDACR [ISPDACR]-S-[1]-60-4-[2]-[3]-[4]-[5]			4		1 ~ 200	50	30	14	12	254.8		10

* In the above model names, [1] indicates the encoder type, [2] the stroke, [3] the applicable controller, [4] the cable length, and [5] the applicable options.

Options

Name	Code	Page	Remarks
AQ seal	AQ	·P18	
Brake	B	·P18	
Anti-electrostatic specification	ESD	·P18	
Reversed home specification	NM	·P18	
Guide with ball-retaining mechanism	RT	·P18	
Suction duct joint on opposite side	VR	·P18	

Common Specifications

Drive system (Note 4)	Ball screw ø2mm, rolled C10 [equivalent to rolled C5]
Backlash (Note 5)	0.05mm or less [0.02mm or less]
Guide	Integrated with base
Grease	Low dust raising grease (for both ball screw and guide)
Allowable load moment	Ma: 28.4N · m, Mb: 40.2N · m, Mc: 65.7N · m
Overhang load length	Ma/Mb/Mc directions: 450mm or less
Base	Material: Aluminum with white alumite treatment
Applicable controller	T1: XSEL-J/K, E-Con, P-Driver; T2: XSEL-P/Q
Cable length (Note 6)	S: 3m, M: 5m, X□□: Length specification
Cleanliness level	Conforming to Class 10 (0.1µm)
Suction duct joint	Quick duct joint with applicable outer tube diameter of ø12

Dimensions

* Note that changing the home direction will require the actuator to be returned to IAI for adjustment.

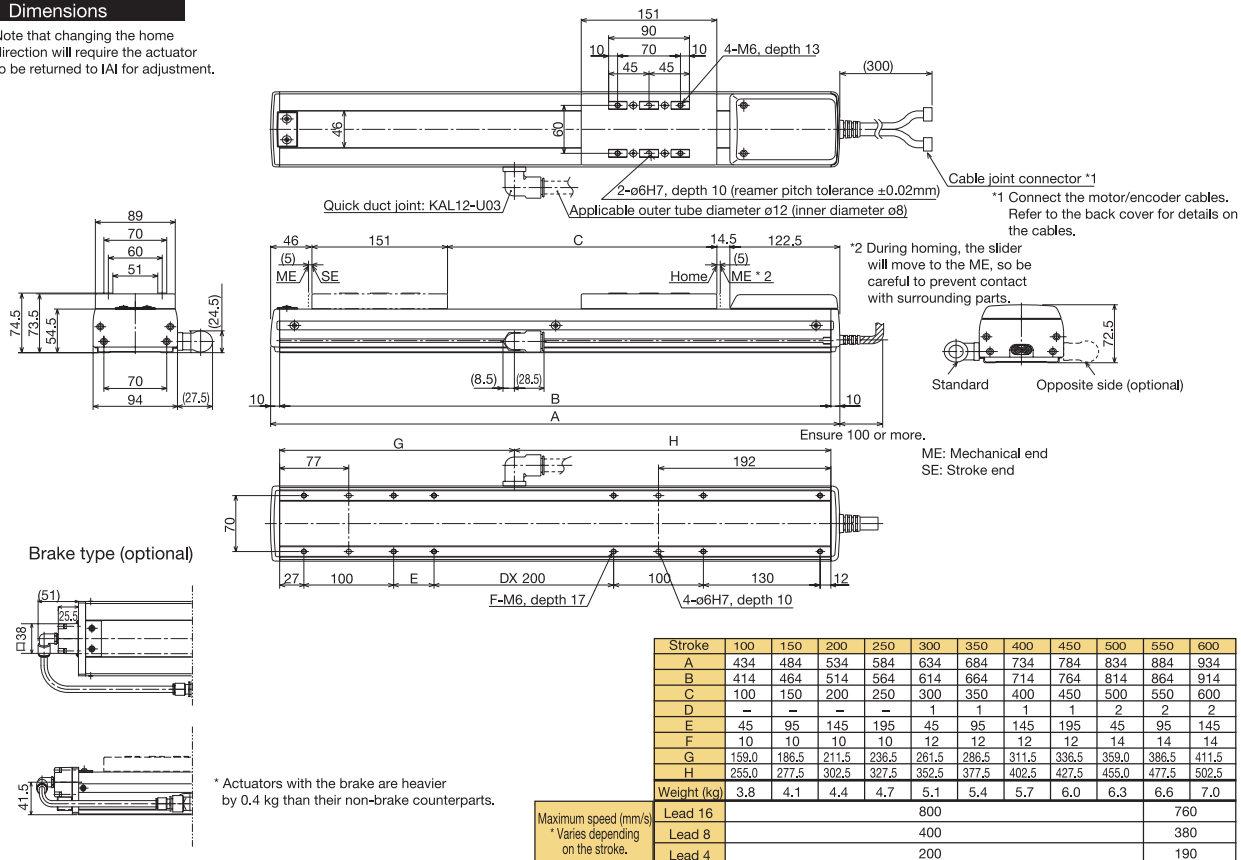

Applicable Controller Specifications

Applicable controller	Maximum number of controlled axes	Compatible encoder type	Operating method	Supply voltage	Page
X-SEL-P/Q	6 axes	Absolute /incremental	Program	3-phase 200VAC	·Back cover
X-SEL-J/K	4 axes			Single-phase 100/200VAC	
E-Con	1 axis	Absolute /incremental	Positioner	AC100/AC200V	·Back cover
P-Driver	1 axis	Incremental	Pulse train	AC100/AC200V	·Back cover



(Note 1) When the stroke increases, the maximum speed drops in order to prevent the ball screw from reaching a dangerous speed. (Refer to the above table for the maximum speed at each stroke.)
(Note 2) Refer to page 18 for the relationship of acceleration and load capacity.
(Notes 3, 4, 5) The figures in [] apply to the ISPDACR Series.
(Note 6) The maximum cable length is 30 m. Specify a desired length in meters. (Example: X08 = 8 m)

ISDACR-M-100

Single-Axis Robot: Medium Cleanroom Type
Actuator Width 125mm, 100W, Straight Shape

ISPDACR-M-100

Single-Axis Robot: Medium Cleanroom Type
Actuator Width 125mm, 100W, Straight Shape, High-Precision Specification

Type / Medium (125 mm wide) Stroke / 100-1000mm Load capacity / 80kg (horizontal)/19kg (vertical)

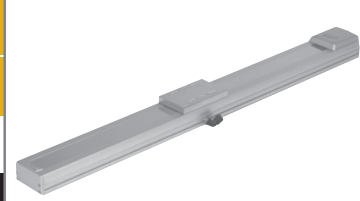

Model specification items Series Type Encoder type Motor output Lead Stroke Applicable controller Cable length Options

(Example) ISDACR - M - A - 100 - 20 - 1000 - T1 - S - B

* Refer to page 1 for the details of model specification items.

Model/Specifications

Model	Encoder Type	Motor output (W)	Lead (mm)	Stroke 50mm increments (mm)	Speed (mm/s) (Note 1)	Load capacity (Note2)				Rated thrust (N)	Positioning repeatability (mm) (Note 3)	Suction rate (Nℓ/min)
						Horizontal (kg)		Vertical (kg)				
						Rated acceleration	Maximum acceleration	Rated acceleration	Maximum acceleration			
ISDACR [ISPDACR]-M-[1]-100-20-[2]-[3]-[4]-[5]	Absolute Incremental	100	20	100 ~ 1000	1 ~ 1000	20	6	3.5	2	84.3	±0.02 [±0.01]	70
ISDACR [ISPDACR]-M-[1]-100-10-[2]-[3]-[4]-[5]			10		1 ~ 500	40	20	9	7	169.5		30
ISDACR [ISPDACR]-M-[1]-100-5-[2]-[3]-[4]-[5]			5		1 ~ 250	80	45	19	15	340.1		15

* In the above model names, [1] indicates the encoder type, [2] the stroke, [3] the applicable controller, [4] the cable length, and [5] the applicable options.

Options

Name	Code	Page	Remarks
AQ seal	AQ	·P18	
Brake	B	·P18	
Anti-electrostatic specification	ESD	·P18	
Reversed home specification	NM	·P18	
Guide with ball-retaining mechanism	RT	·P18	
Suction duct joint on opposite side	VR	·P18	

Common Specifications

Drive system (Note 4)	Ball screw ϕ 16mm, rolled C10 [equivalent to rolled C5]
Backlash (Note 5)	0.05mm or less [0.02mm or less]
Guide	Integrated with base
Grease	Low dust raising grease (for both ball screw and guide)
Allowable load moment	Ma: 69.6N · m, Mb: 99.0N · m, Mc: 161.7N · m
Overhang load length	Ma/Mb/Mc directions: 600mm or less
Base	Material: Aluminum with white alumite treatment
Applicable controller	T1: XSEL-J/K, E-Con, P-Driver; T2: XSEL-P/Q
Cable length (Note 6)	S: 3m, M: 5m, X□□: Length specification
Cleanliness level	Conforming to Class 10 (0.1 μ m)
Suction duct joint	Quick duct joint with applicable outer tube diameter of ϕ 12

Dimensions

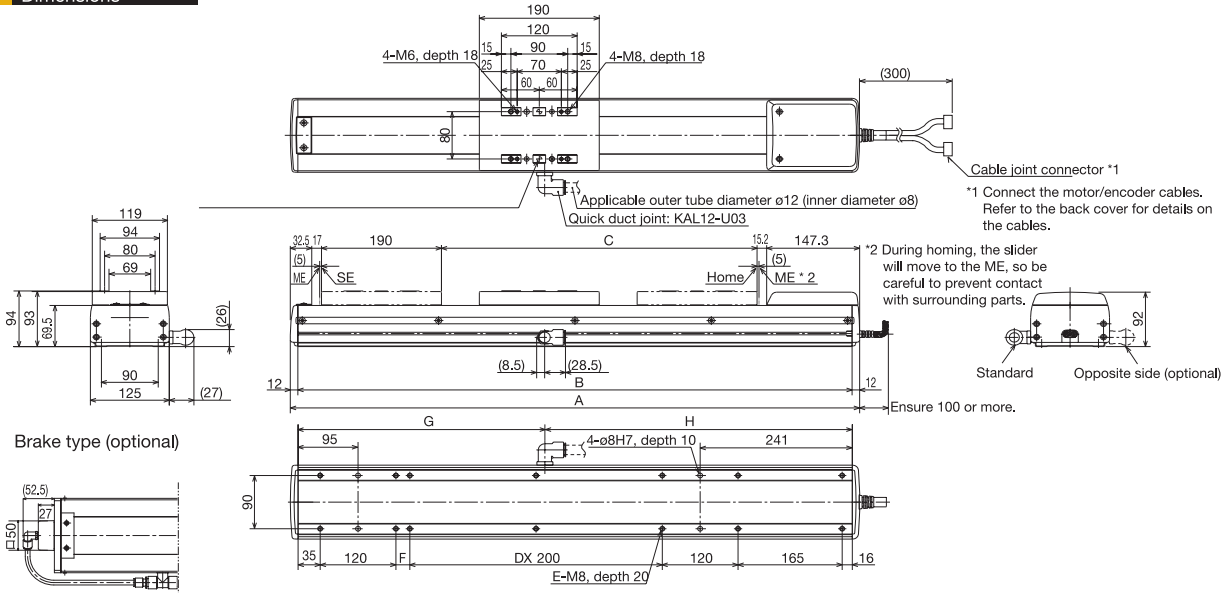

* Actuators with the brake are heavier by 0.7 kg than their non-brake counterparts.

Stroke	100	150	200	250	300	350	400	450	500	550	600	650	700	750	800	850	900	950	1000	
A	502	552	602	652	702	752	802	852	902	952	1002	1052	1102	1152	1202	1252	1302	1352	1402	
B	478	528	578	628	678	728	778	828	878	928	978	1028	1078	1128	1178	1228	1278	1328	1378	
C	100	150	200	250	300	350	400	450	500	550	600	650	700	750	800	850	900	950	1000	
D	-	-	-	-	1	1	1	1	2	2	2	2	3	3	3	3	4	4	4	
E	10	10	10	10	12	12	12	12	14	14	14	14	16	16	16	16	18	18	18	
F	22	72	122	172	22	72	122	172	22	72	122	172	22	72	122	172	122	72	122	
G	191	213	240	265	290	315	340	365	391	413	440	465	490	515	540	565	591	613	640	
H	287	315	338	363	388	413	438	463	487	515	538	563	588	613	638	663	687	715	738	
Weight (kg)	8.2	8.8	9.3	9.9	10.5	11.1	11.6	12.2	12.7	13.3	13.9	14.5	15.0	15.6	16.1	16.7	17.3	17.9	18.4	
Maximum speed (mm/s) * Varies depending on the stroke.	Lead 20	1000															915	735	600	500
	Lead 10	500															455	365	300	250
	Lead 5	250															225	180	150	125

Applicable Controller Specifications

Applicable controller	Maximum number of controlled axes	Compatible encoder type	Operating method	Supply voltage	Page
X-SEL-P/Q	6 axes	Absolute /incremental	Program	3-phase 200VAC	Back cover
X-SEL-J/K	4 axes			Single-phase 100/200VAC	
E-Con	1 axis	Absolute /incremental	Positioner	AC100/AC200V	Back cover
P-Driver	1 axis	Incremental	Pulse train	AC100/AC200V	Back cover



(Note 1) When the stroke increases, the maximum speed drops in order to prevent the ball screw from reaching a dangerous speed. (Refer to the above table for the maximum speed at each stroke.)
(Note 2) Refer to page 18 for the relationship of acceleration and load capacity.
(Notes 3, 4, 5) The figures in [] apply to the ISPDACR Series.
(Note 6) The maximum cable length is 30 m. Specify a desired length in meters. (Example: X08 = 8 m)

ISDACR-M-200

Single-Axis Robot: Medium Cleanroom Type
Actuator Width 125mm, 200W, Straight Shape

ISPDACR-M-200

Single-Axis Robot: Medium Cleanroom Type
Actuator Width 125mm, 200W, Straight Shape, High-Precision Specification

Type Medium (125 mm wide)

Stroke 100-1000mm

Load capacity 80kg (horizontal)/19kg (vertical)

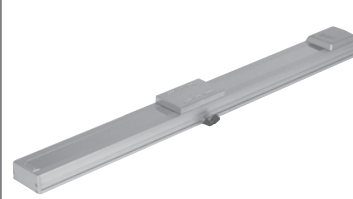

Model specification items Series Type Encoder type Motor output Lead Stroke Applicable controller Cable length Options
(Example) ISDACR - M - A - 200 - 20 - 1000 - T1 - S - B

* Refer to page 1 for the details of model specification items.

Model/Specifications

Model	Encoder Type	Motor output (W)	Lead (mm)	Stroke 50mm increments (mm)	Speed (mm/s) (Note 1)	Load capacity (Note2)				Rated thrust (N)	Positioning repeatability (mm) (Note 3)	Suction rate (Nl/min)
						Horizontal (kg)		Vertical (kg)				
						Rated acceleration	Maximum acceleration	Rated acceleration	Maximum acceleration			
ISDACR [ISPDACR]-M-[1]-200-20-[2]-[3]-[4]-[5]	Absolute	200	20	100 ~ 1000	1 ~ 1000	40	12	9	5	169.5	±0.02	70
ISDACR [ISPDACR]-M-[1]-200-10-[2]-[3]-[4]-[5]	Incremental		10		1 ~ 500	80	40	19	15	340.1	[±0.01]	30

*In the above model names, [1] indicates the encoder type, [2] the stroke, [3] the applicable controller, [4] the cable length, and [5] the applicable options.
*We accept a lead 30 specification as a custom order.

Options

Name	Code	Page	Remarks
AQ seal	AQ	·P18	
Brake	B	·P18	
Anti-electrostatic specification	ESD	·P18	
Reversed home specification	NM	·P18	
Guide with ball-retaining mechanism	RT	·P18	
Suction duct joint on opposite side	VR	·P18	

Common Specifications

Drive system (Note 4)	Ball screw ø16mm, rolled C10 [equivalent to rolled C5]
Backlash (Note 5)	0.05mm or less [0.02mm or less]
Guide	Integrated with base
Grease	Low dust raising grease (for both ball screw and guide)
Allowable load moment	Ma: 69.6N · m, Mb: 99.0N · m, Mc: 161.7N · m
Overhang load length	Ma/Mb/Mc directions: 600mm or less
Base	Material: Aluminum with white alumite treatment
Applicable controller	T1: XSEL-J/K, E-Con, P-Driver; T2: XSEL-P/Q
Cable length (Note 6)	S: 3m, M: 5m, X□□: Length specification
Cleanliness level	Conforming to Class 10 (0.1µm)
Suction duct joint	Quick duct joint with applicable outer tube diameter of ø12

Dimensions

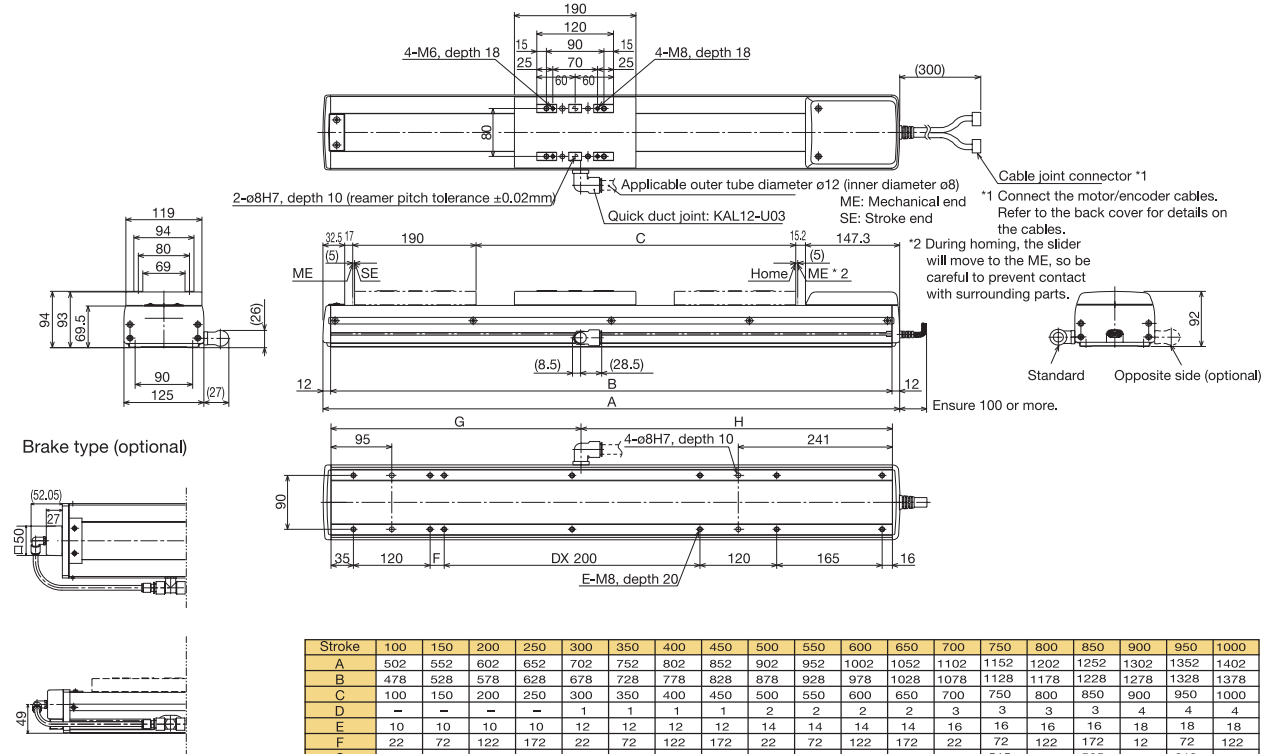

Brake type (optional)

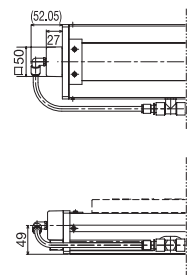

* Actuators with the brake are heavier by 0.7 kg than their non-brake counterparts.

Stroke	100	150	200	250	300	350	400	450	500	550	600	650	700	750	800	850	900	950	1000
A	502	552	602	652	702	752	802	852	902	952	1002	1052	1102	1152	1202	1252	1302	1352	1402
B	478	528	578	628	678	728	778	828	878	928	978	1028	1078	1128	1178	1228	1278	1328	1378
C	100	150	200	250	300	350	400	450	500	550	600	650	700	750	800	850	900	950	1000
D	-	-	-	1	1	1	1	1	2	2	2	2	3	3	3	3	4	4	4
E	10	10	10	10	12	12	12	12	14	14	14	14	16	16	16	16	18	18	18
F	22	72	122	172	22	72	122	172	22	72	122	172	22	72	122	172	12	72	122
G	191	213	240	265	290	315	340	365	391	413	440	465	490	515	540	565	591	613	640
H	287	315	338	363	388	413	438	463	487	515	538	563	588	613	638	663	687	715	738
Weight (kg)	8.4	9.0	9.6	10.2	10.7	11.3	11.9	12.5	13.0	13.6	14.1	15.7	15.3	15.9	16.4	17.0	17.5	18.1	18.7
Maximum speed (mm/s)	Lead 20											915		735		600		500	
	Lead 10											455		365		300		250	

Applicable Controller Specifications

Applicable controller	Maximum number of controlled axes	Compatible encoder type	Operating method	Supply voltage	Page
X-SEL-P/Q	6 axes	Absolute /incremental	Program	3-phase 200VAC	Back cover
X-SEL-J/K	4 axes				
E-Con	1 axis	Absolute /incremental	Positioner	AC100V/AC200V	Back cover
P-Driver	1 axis				



(Note 1) When the stroke increases, the maximum speed drops in order to prevent the ball screw from reaching a dangerous speed. (Refer to the above table for the maximum speed at each stroke.)
(Note 2) Refer to page 18 for the relationship of acceleration and load capacity.
(Notes 3, 4, 5) The figures in [] apply to the ISPDACR Series.
(Note 6) The maximum cable length is 30 m. Specify a desired length in meters. (Example: X08 = 8 m)

ISDACR-MX-200

Single-Axis Robot: Medium Cleanroom Mid-support Type
Actuator Width 125mm, 200W, Straight Shape

ISPDACR-MX-200

Single-Axis Robot Medium Cleanroom Mid-support Type
Actuator Width 125mm, 200W, Straight Shape, High-Precision Specification

Type	Medium (125 mm wide) Mid-support Type	Stroke	800~2000mm	Load capacity	40kg (horizontal)
------	--	--------	------------	---------------	-------------------

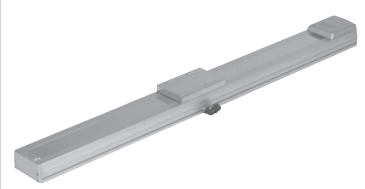

Model specification items Series Type Encoder type Motor output Lead Stroke Applicable controller Cable length Options

(Example) ISDACR - MX - A - 200 - 20 - 2000 - T1 - S - B

* Refer to page 1 for the details of model specification items.

Model/Specifications

Model	Encoder Type	Motor output (W)	Lead (mm)	Stroke 100mm increments (mm)	Speed (mm/s) (Note 1)	Load capacity (Note 2)				Rated thrust (N)	Positioning repeatability (mm) (Note 3)	Suction rate (Nℓ/min)
						Horizontal (kg)		Vertical (kg)				
						Rated acceleration	Maximum acceleration	Rated acceleration	Maximum acceleration			
ISDACR [ISPDACR]-MX-[1]-200-[2]-[3]-[4]-[5]	Absolute Incremental	200	20	800 ~ 2000	1 ~ 1000	40	Horizontal only		169.5	±0.02 [±0.01]	70	

* In the above model names, [1] indicates the encoder type, [2] the stroke, [3] the applicable controller, [4] the cable length, and [5] the applicable options.

Options

Name	Code	Page	Remarks
AQ seal	AQ	▶P18	
Brake	B	▶P18	
Reversed home specification	NM	▶P18	
Guide with ball-retaining mechanism	RT	▶P18	
Suction duct joint on opposite side	VR	▶P18	

Common Specifications

Drive system (Note 4)	Ball screw ø16mm, rolled C10 [equivalent to rolled C5]
Backlash (Note 5)	0.05mm or less [0.02mm or less]
Guide	Integrated with base
Grease	Low dust raising grease (for both ball screw and guide)
Allowable load moment	Ma: 69.6N • m, Mb: 99.0N • m, Mc: 161.7N • m
Overhang load length	Ma/Mb/Mc directions: 450mm or less
Base	Material: Aluminum with white alumite treatment
Applicable controller	T1: XSEL-J/K, E-Con, P-Driver; T2: XSEL-P/Q
Cable length (Note 6)	S: 3m, M: 5m, X□□: Length specification
Cleanliness level	Conforming to Class 10 (0.1µm)
Suction duct joint	Quick duct joint with applicable outer tube diameter of ø12

Dimensions

* Note that changing the home direction will require the actuator to be returned to IAI for adjustment.

* Due to their structure, the mid-support type cannot be positioned horizontally on their side, or in vertical direction.

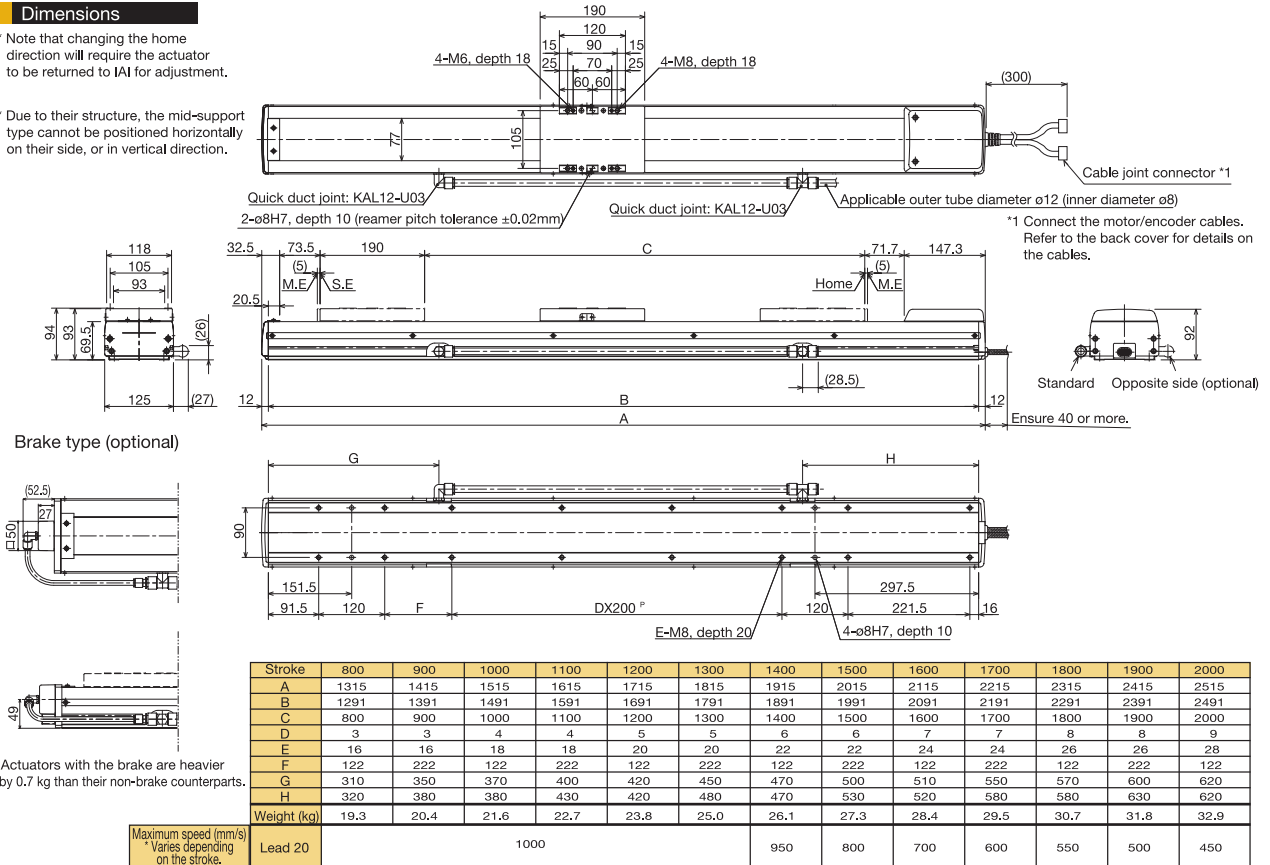

* Actuators with the brake are heavier by 0.7 kg than their non-brake counterparts.

Maximum speed (mm/s)
Varies depending on the stroke.

Applicable Controller Specifications

Applicable controller	Maximum number of controlled axes	Compatible encoder type	Operating method	Supply voltage	Page
X-SEL-P/Q	6 axes	Absolute /incremental	Program	3-phase 200VAC	Back cover
X-SEL-J/K	4 axes			Single-phase 100/200VAC	
E-Con	1 axis	Absolute /incremental	Positioner	AC100/AC200V	Back cover
P-Driver	1 axis	Incremental	Pulse train	AC100/AC200V	Back cover

Caution

(Note 1) When the stroke increases, the maximum speed drops in order to prevent the ball screw from reaching a dangerous speed. (Refer to the above table for the maximum speed at each stroke.)

(Note 2) Refer to page 18 for the relationship of acceleration and load capacity.

(Notes 3, 4, 5) The figures in [] apply to the ISPDACR Series.

(Note 6) The maximum cable length is 30 m. Specify a desired length in meters. (Example: X08 = 8 m)

ISDACR-L-200

Single-Axis Robot: Large Cleanroom Type
Actuator Width 155mm, 200W, Straight Shape

ISPDACR-L-200

Single-Axis Robot: Large Cleanroom Type
Actuator Width 155mm, 200W, Straight Shape, High-Precision Specification

Type / Large (155 mm wide)

Stroke / 100~1200mm

Load capacity / 80kg (horizontal)/19kg (vertical)

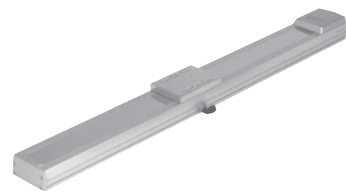

Model specification items Series Type Encoder type Motor output Lead Stroke Applicable controller Cable length Options

(Example) ISDACR - L - A - 200 - 20 - 1200 - T1 - S - B

* Refer to page 1 for the details of model specification items.

Model/Specifications

Model	Encoder Type	Motor output (W)	Lead (mm)	Stroke 50mm increments (mm)	Speed (mm/s) (Note 1)	Load capacity (Note2)				Rated thrust (N)	Positioning repeatability (mm) (Note 3)	Suction rate (Nl/min)
						Horizontal (kg)		Vertical (kg)				
						Rated acceleration	Maximum acceleration	Rated acceleration	Maximum acceleration			
ISDACR [ISPDACR]-L-[1]-200-20-[2]-[3]-[4]-[5]	Absolute	200	20	100 ~ 1200	1 ~ 1000	40	12	9	4	169.5	±0.02	90
ISDACR [ISPDACR]-L-[1]-200-10-[2]-[3]-[4]-[5]	Incremental		10			1 ~ 500	80	40	19	14	340.1	[±0.01]

* In the above model names, [1] indicates the encoder type, [2] the stroke, [3] the applicable controller, [4] the cable length, and [5] the applicable options.

Options

Name	Code	Page	Remarks
AQ seal	AQ	·P18	
Brake	B	·P18	
Anti-electrostatic specification	ESD	·P18	The maximum supported stroke is 1000 mm.
Reversed home specification	NM	·P18	
Guide with ball-retaining mechanism	RT	·P18	
Suction duct joint on opposite side	VR	·P18	

Common Specifications

Drive system (Note 4)	Ball screw ø20mm, rolled C10 [equivalent to rolled C5]
Backlash (Note 5)	0.05mm or less [0.02mm or less]
Guide	Integrated with base
Grease	Low dust raising grease (for both ball screw and guide)
Allowable load moment	Ma: 104.9N · m, Mb: 149.9N · m, Mc: 248.9N · m
Overhang load length	Ma/Mb/Mc directions: 750mm or less
Base	Material: Aluminum with white alumite treatment
Applicable controller	T1: XSEL-J/K, E-Con, P-Driver; T2: XSEL-P/Q
Cable length (Note 6)	S: 3m, M: 5m, X□□: Length specification
Cleanliness level	Conforming to Class 10 (0.1µm)
Suction duct joint	Quick duct joint with applicable outer tube diameter of ø12

Dimensions

* Note that changing the home direction will require the actuator to be returned to IAI for adjustment.

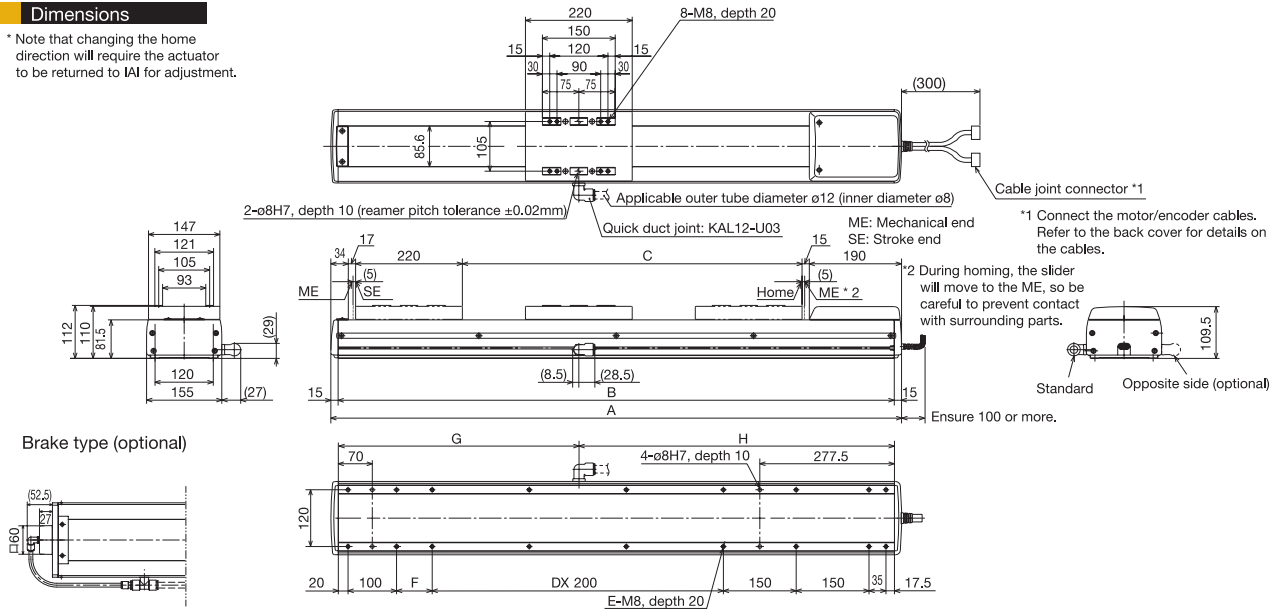

Brake type (optional)

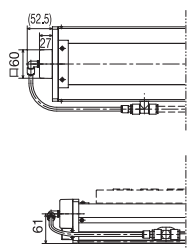

Stroke	100	150	200	250	300	350	400	450	500	550	600	650	700	750	800	850	900	950	1000	1050	1100	1150	1200
A	576	626	676	726	776	826	876	926	976	1026	1076	1126	1176	1226	1276	1326	1376	1426	1476	1526	1576	1626	1676
B	546	596	646	696	746	796	846	896	946	996	1046	1096	1146	1196	1246	1296	1346	1396	1446	1496	1546	1596	1646
C	100	150	200	250	300	350	400	450	500	550	600	650	700	750	800	850	900	950	1000	1050	1100	1150	1200
D	-	-	-	1	1	1	1	2	2	2	2	3	3	3	3	4	4	4	4	4	5	5	5
E	12	12	12	14	14	14	14	16	16	16	16	18	18	18	18	20	20	20	20	22	22	22	22
F	73.5	123.5	173.5	23.5	73.5	123.5	173.5	23.5	73.5	123.5	173.5	23.5	73.5	123.5	173.5	23.5	73.5	123.5	173.5	23.5	73.5	123.5	173.5
G	179.5	221.0	246.0	271.0	296.0	321.0	346.0	371.0	379.5	421.0	446.0	471.0	496.0	521.0	546.0	571.0	579.5	621.0	646.0	671.0	696.0	721.0	746.0
H	366.5	375	400.0	425.0	450.0	475.0	500.0	525.0	566.5	575.0	600.0	625.0	650.0	675.0	700.0	725.0	766.5	775.0	800.0	825.0	850.0	875.0	900.0
Weight (kg)	13.2	14.0	14.8	15.6	16.4	17.2	18.0	18.8	19.6	20.4	21.2	22.0	22.8	23.6	24.4	25.2	26.0	26.8	27.6	28.4	29.2	30.0	30.8
Maximum speed (mm/s) *1 Varies depending on the stroke.	Lead 20															930	765	640	545	465			
	Lead 10															465	380	320	270	230			

* Actuators with the brake are heavier by 1.1 kg than their non-brake counterparts.

Applicable Controller Specifications

Applicable controller	Maximum number of controlled axes	Compatible encoder type	Operating method	Supply voltage	Page
X-SEL-P/Q	6 axes	Absolute / incremental	Program	3-phase 200VAC	·Back cover
X-SEL-J/K	4 axes			Single-phase 100/200VAC	
E-Con	1 axis	Absolute / incremental	Positioner	AC100V / AC200V	·Back cover
P-Driver	1 axis	Incremental	Pulse train	AC100V / AC200V	·Back cover



Caution

(Note 1) When the stroke increases, the maximum speed drops in order to prevent the ball screw from reaching a dangerous speed. (Refer to the above table for the maximum speed at each stroke.)
(Note 2) Refer to page 18 for the relationship of acceleration and load capacity.
(Notes 3, 4, 5) The figures in [] apply to the ISPDACR Series.
(Note 6) The maximum cable length is 30 m. Specify a desired length in meters. (Example: X08 = 8 m)

ISDACR-L-400

Single-Axis Robot: Large Cleanroom Type
Actuator Width 155mm, 400W, Straight Shape

ISPDACR-L-400

Single-Axis Robot: Large Cleanroom Type
Actuator Width 155mm, 400W, Straight Shape, High-Precision Specification

Type Large (155 mm wide) Stroke 100-1200mm Load capacity 80kg (horizontal)/19kg (vertical)

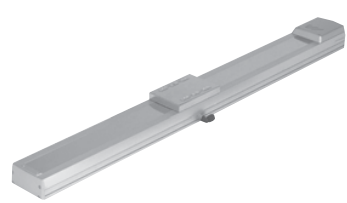

Model specification items Series Type Encoder type Motor output Lead Stroke Applicable controller Cable length Options

(Example) ISDACR - L - A - 400 - 20 - 1200 - T1 - S - B

* Refer to page 1 for the details of model specification items.

Model/Specifications

Model	Encoder Type	Motor output (W)	Lead (mm)	Stroke 50mm increments (mm)	Speed (mm/s) (Note 1)	Load capacity (Note2)				Rated thrust (N)	Positioning repeatability (mm) (Note 3)	Suction rate (Nℓ/min)
						Horizontal (kg)		Vertical (kg)				
						Rated acceleration	Maximum acceleration	Rated acceleration	Maximum acceleration			
ISDACR [ISPDACR]-L- [1]-400-20-[2]-[3]-[4]-[5]	Absolute Incremental	400	20	100 ~ 1200	1 ~ 1000	80	24	19	10	340.1	±0.02 [±0.01]	90

*In the above model names, [1] indicates the encoder type, [2] the stroke, [3] the applicable controller, [4] the cable length, and [5] the applicable options.
*We accept a lead 30 specification as a custom order.

Options

Name	Code	Page	Remarks
AQ seal	AQ	·P18	
Brake	B	·P18	
Anti-electrostatic specification	ESD	·P18	The maximum supported stroke is 1000 mm.
Reversed home specification	NM	·P18	
Guide with ball-retaining mechanism	RT	·P18	
Suction duct joint on opposite side	VR	·P18	

Common Specifications

Drive system (Note 4)	Ball screw $\phi 20$ mm, rolled C10 [equivalent to rolled C5]
Backlash (Note 5)	0.05mm or less [0.02mm or less]
Guide	Integrated with base
Grease	Low dust raising grease (for both ball screw and guide)
Allowable load moment	Ma: 104.9N · m, Mb: 149.9N · m, Mc: 248.9N · m
Overhang load length	Ma/Mb/Mc directions: 750mm or less
Base	Material: Aluminum with white alumite treatment
Applicable controller	T1: XSEL-J/K, E-Con, P-Driver; T2: XSEL-P/Q
Cable length (Note 6)	S: 3m, M: 5m, X□□: Length specification
Cleanliness level	Conforming to Class 10 (0.1 μ m)
Suction duct joint	Quick duct joint with applicable outer tube diameter of $\phi 12$

Dimensions

* Note that changing the home direction will require the actuator to be returned to IAI for adjustment.

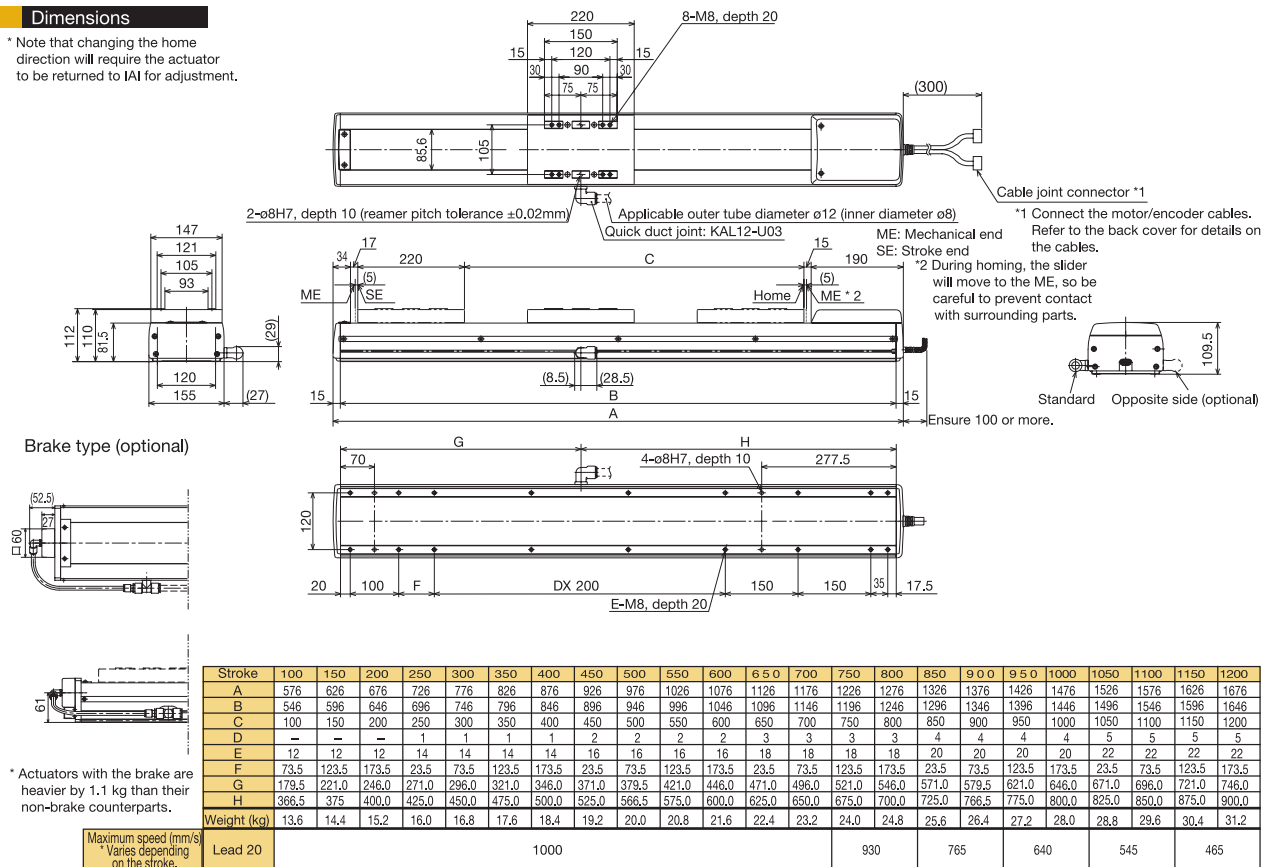

* Actuators with the brake are heavier by 1.1 kg than their non-brake counterparts.

Maximum speed (mm/s)
*Varies depending on the stroke.

Applicable Controller Specifications

Applicable controller	Maximum number of controlled axes	Compatible encoder type	Operating method	Supply voltage	Page
X-SEL-P/Q	6 axes	Absolute /incremental	Program	3-phase 200VAC	Back cover
X-SEL-J/K	4 axes			Single-phase 100/200VAC	
E-Con	1 axis	Absolute /incremental	Positioner	AC100/AC200V	Back cover
P-Driver	1 axis	Incremental	Pulse train	AC100/AC200V	Back cover



(Note 1) When the stroke increases, the maximum speed drops in order to prevent the ball screw from reaching a dangerous speed. (Refer to the above table for the maximum speed at each stroke.)
(Note 2) Refer to page 18 for the relationship of acceleration and load capacity.
(Notes 3, 4, 5) The figures in [] apply to the ISPDACR Series.
(Note 6) The maximum cable length is 30 m. Specify a desired length in meters. (Example: X08 = 8 m)

15

Sold & Serviced By:

ELECTROMATE

Toll Free Phone (877) SERV098

Toll Free Fax (877) SERV099

www.electromate.com

sales@electromate.com

ISDACR-LX-200

Single-Axis Robot: Large Cleanroom Mid-support Type
Actuator Width 155mm, 200W, Straight Shape

ISPDACR-LX-200

Single-Axis Robot: Large Cleanroom Mid-support Type
Actuator Width 155mm, 200W, Straight Shape, High-Precision Specification

Type	Large (155 mm wide) Mid-support Type	Stroke	1000-2500mm	Load capacity	40kg (horizontal)
------	---	--------	-------------	---------------	-------------------

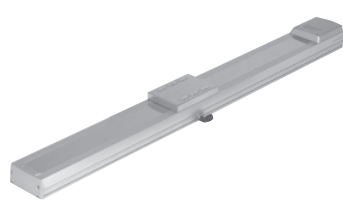

Model specification items: Series, Type, Encoder type, Motor output, Lead, Stroke, Applicable controller, Cable length, Options
(Example) ISDACR - LX - A - 200 - 20 - 2500 - T1 - S - B

* Refer to page 1 for the details of model specification items.

Model/Specifications

Model	Encoder Type	Motor output (W)	Lead (mm)	Stroke 100mm increments (mm)	Speed (mm/s) (Note 1)	Load capacity (Note2)				Rated thrust (N)	Positioning repeatability (mm) (Note 3)	Suction rate (N/min)
						Horizontal (kg)		Vertical (kg)				
						Rated acceleration	Maximum acceleration	Rated acceleration	Maximum acceleration			
ISDACR [ISPDACR]-LX-[1]-200-20-[2]-[3]-[4]-[5]	Absolute Incremental	200	20	1000 ~ 2500	1 ~ 1000	40	Horizontal only		169.5	±0.02 [±0.01]	90	

* In the above model names, [1] indicates the encoder type, [2] the stroke, [3] the applicable controller, [4] the cable length, and [5] the applicable options.

Options

Name	Code	Page	Remarks
AQ seal	AQ	·P18	
Brake	B	·P18	
Reversed home specification	NM	·P18	
Guide with ball-retaining mechanism	RT	·P18	
Suction duct joint on opposite side	VR	·P18	

Common Specifications

Drive system (Note 4)	Ball screw ø20mm, rolled C10 [equivalent to rolled C5]
Backlash (Note 5)	0.05mm or less [0.02mm or less]
Guide	Integrated with base
Grease	Low dust raising grease (for both ball screw and guide)
Allowable load moment	Ma: 104.9N · m, Mb: 149.9N · m, Mc: 248.9N · m
Overhang load length	Ma/Mb/Mc directions: 750mm or less
Base	Material: Aluminum with white alumite treatment
Applicable controller	T1: XSEL-J/K, E-Con, P-Driver; T2: XSEL-P/Q
Cable length (Note 6)	S: 3m, M: 5m, X□□: Length specification
Cleanliness level	Conforming to Class 10 (0.1µm)
Suction duct joint	Quick duct joint with applicable outer tube diameter of ø12

Dimensions

* Note that changing the home direction will require the actuator to be returned to IAI for adjustment.

* Due to their structure, the mid-support type cannot be positioned horizontally on their side, or in vertical direction.

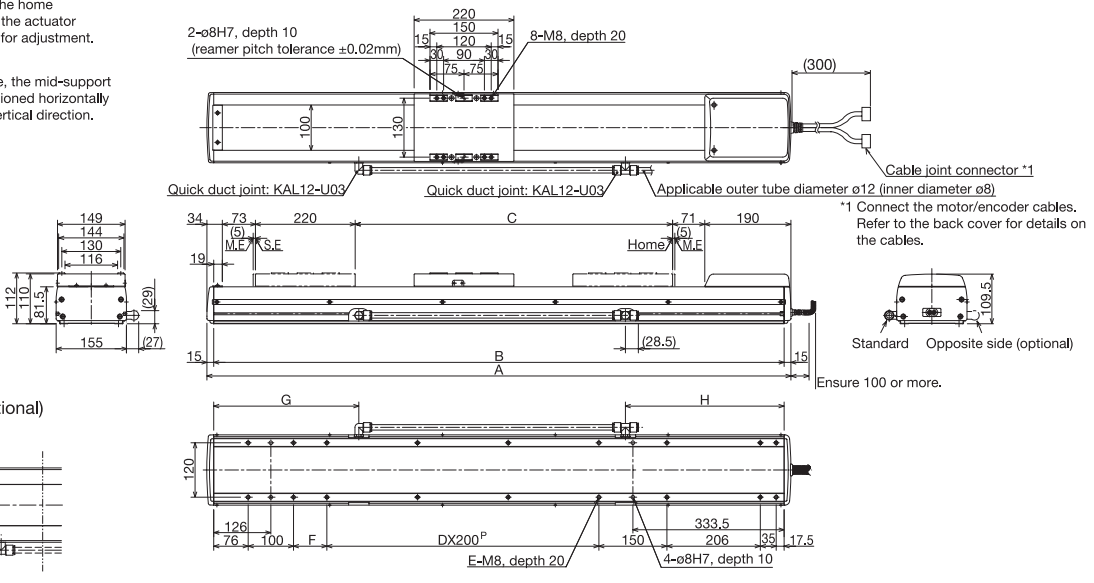

Brake type (optional)

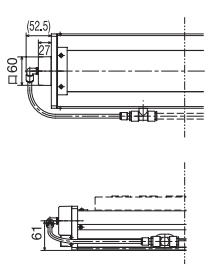

* Actuators with the brake are heavier by 1.1 kg than their non-brake counterparts.

Stroke	1000	1100	1200	1300	1400	1500	1600	1700	1800	1900	2000	2100	2200	2300	2400	2500
A	1588	1688	1788	1888	1988	2088	2188	2288	2388	2488	2588	2688	2788	2888	2988	3088
B	1558	1658	1758	1858	1958	2058	2158	2258	2358	2458	2558	2658	2758	2858	2958	3058
C	1000	1100	1200	1300	1400	1500	1600	1700	1800	1900	2000	2100	2200	2300	2400	2500
D	4	5	5	6	6	7	7	8	8	9	9	10	10	11	11	12
E	20	22	22	24	24	26	26	28	28	30	30	32	32	34	34	36
F	173.5	173.5	173.5	173.5	173.5	173.5	173.5	173.5	173.5	173.5	173.5	173.5	173.5	173.5	173.5	173.5
G	390	420	440	470	490	520	530	570	590	620	640	670	690	720	730	770
H	390	450	440	500	490	550	540	590	590	650	640	700	690	750	740	790
Weight (kg)	31.7	33.3	34.9	36.5	38.1	39.8	41.4	43.0	44.6	46.2	47.8	49.4	51.0	52.6	54.2	55.8
Lead 20	1000			950			830	740	650	590	540	490	440	410	370	340

Maximum speed (mm/s)
* Varies depending on the stroke.

Applicable Controller Specifications

Applicable controller	Maximum number of controlled axes	Compatible encoder type	Operating method	Supply voltage	Page
X-SEL-P/Q	6 axes	Absolute /incremental	Program	3-phase 200VAC	·Back cover
X-SEL-J/K	4 axes			Single-phase 100/200VAC	
E-Con	1 axis	Absolute /incremental	Positioner	AC100/AC200V	·Back cover
P-Driver	1 axis	Incremental	Pulse train	AC100/AC200V	·Back cover

Caution
(Note 1) When the stroke increases, the maximum speed drops in order to prevent the ball screw from reaching a dangerous speed. (Refer to the above table for the maximum speed at each stroke.)
(Note 2) Refer to page 18 for the relationship of acceleration and load capacity.
(Notes 3, 4, 5) The figures in [] apply to the ISPDACR Series.
(Note 6) The maximum cable length is 30 m. Specify a desired length in meters. (Example: X08 = 8 m)

ISDACR-LX-400

Single-Axis Robot: Large Cleanroom Mid-support Type
Actuator Width 155mm, 400W, Straight Shape

ISPDACR-LX-400

Single-Axis Robot: Large Cleanroom Mid-support Type
Actuator Width 155mm, 400W, Straight Shape, High-Precision Specification

Type	Large (155 mm wide) Mid-support Type	Stroke	1000-2500mm	Load capacity	80kg (horizontal)
------	---	--------	-------------	---------------	-------------------

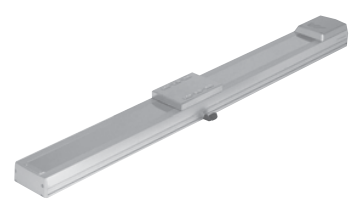

Model specification items Series Type Encoder type Motor output Lead Stroke Applicable controller Cable length Options
(Example) ISDACR - LX - A - 400 - 20 - 2500 - T1 - S - B

* Refer to page 1 for the details of model specification items.

Model/Specifications

Model	Encoder Type	Motor output (W)	Lead (mm)	Stroke 100mm increments (mm)	Speed (mm/s) (Note 1)	Load capacity (Note2)				Rated thrust (N)	Positioning repeatability (mm) (Note 3)	Suction rate (NL/min)
						Horizontal (kg)		Vertical (kg)				
						Rated acceleration	Maximum acceleration	Rated acceleration	Maximum acceleration			
ISDACR [ISPDACR]-LX-[1]-400-20-[2]-[3]-[4]-[5]	Absolute Incremental	400	20	1000 ~ 2500	1 ~ 1000	80	Horizontal only			340.1	±0.02 [±0.01]	90

* In the above model names, [1] indicates the encoder type, [2] the stroke, [3] the applicable controller, [4] the cable length, and [5] the applicable options.

Options

Name	Code	Page	Remarks
AQ seal	AQ	·P18	
Brake	B	·P18	
Reversed home specification	NM	·P18	
Guide with ball-retaining mechanism	RT	·P18	
Suction duct joint on opposite side	VR	·P18	

Common Specifications

Drive system (Note 4)	Ball screw ø20mm, rolled C10 [equivalent to rolled C5]
Backlash (Note 5)	0.05mm or less [0.02mm or less]
Guide	Integrated with base
Grease	Low dust raising grease (for both ball screw and guide)
Allowable load moment	Ma: 104.9N·m, Mb: 149.9N·m, Mc: 248.9N·m
Overhang load length	Ma/Mb/Mc directions: 750mm or less
Base	Material: Aluminum with white alumite treatment
Applicable controller	T1: XSEL-J/K, E-Con, P-Driver; T2: XSEL-P/Q
Cable length (Note 6)	S: 3m, M: 5m, X□□: Length specification
Cleanliness level	Conforming to Class 10 (0.1µm)
Suction duct joint	Quick duct joint with applicable outer tube diameter of ø12

Dimensions

* Note that changing the home direction will require the actuator to be returned to IAI for adjustment.

* Due to their structure, the mid-support type cannot be positioned horizontally on their side, or in vertical direction.

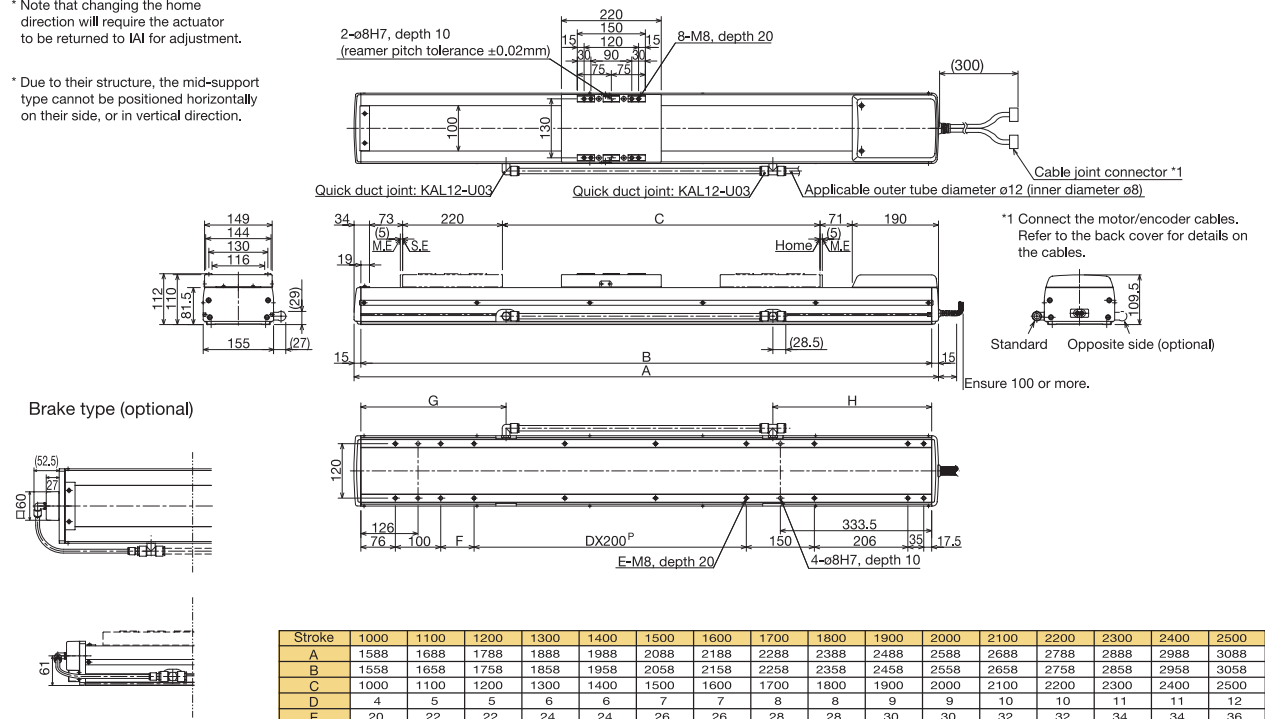

Brake type (optional)

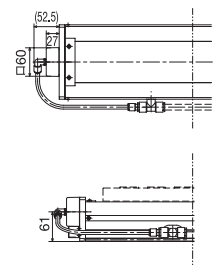

* Actuators with the brake are heavier by 1.1 kg than their non-brake counterparts.

Stroke	1000	1100	1200	1300	1400	1500	1600	1700	1800	1900	2000	2100	2200	2300	2400	2500
A	1588	1688	1788	1888	1988	2088	2188	2288	2388	2488	2588	2688	2788	2888	2988	3088
B	1558	1658	1758	1858	1958	2058	2158	2258	2358	2458	2558	2658	2758	2858	2958	3058
C	1000	1100	1200	1300	1400	1500	1600	1700	1800	1900	2000	2100	2200	2300	2400	2500
D	4	5	5	6	6	7	7	8	8	9	9	10	10	11	11	12
E	20	22	22	24	24	26	26	28	28	30	30	32	32	34	34	36
F	173.5	73.5	173.5	73.5	173.5	73.5	173.5	73.5	173.5	73.5	173.5	73.5	173.5	73.5	173.5	73.5
G	390	420	440	470	490	520	530	570	590	620	640	670	690	720	730	770
H	390	450	440	500	490	550	540	590	590	650	640	700	690	750	740	790
Weight (kg)	32.1	33.7	35.3	36.9	38.5	40.1	41.7	43.4	45.0	46.6	48.2	49.8	51.4	53.0	54.6	56.2
Lead 20	1000					950	830	740	650	590	540	490	440	410	370	340

Applicable Controller Specifications

Applicable controller	Maximum number of controlled axes	Compatible encoder type	Operating method	Supply voltage	Page
X-SEL-P/Q	6 axes	Absolute /incremental	Program	3-phase 200VAC	-Back cover
X-SEL-J/K	4 axes			Single-phase 100/200VAC	
E-Con	1 axis	Absolute /incremental	Positioner	AC100V / AC200V	-Back cover
P-Driver	1 axis	Incremental	Pulse train	AC100V / AC200V	-Back cover

(Note 1) When the stroke increases, the maximum speed drops in order to prevent the ball screw from reaching a dangerous speed. (Refer to the above table for the maximum speed at each stroke.)
(Note 2) Refer to page 18 for the relationship of acceleration and load capacity.
(Notes 3, 4, 5) The figures in [] apply to the ISPDACR Series.
(Note 6) The maximum cable length is 30 m. Specify a desired length in meters. (Example: X08 = 8 m)

AQ Seal**Code AQ**

Description The AQ seal is a lubrication unit that uses lubricating material made of resin-solidified lubricating oil. The porous material impregnated with a large amount of lubricating oil slowly releases oil from its surface via capillary effect. The guide and ball screw surfaces (steel-ball rolling surface) are constantly lubricated as AQ seals are pressed against these surfaces. When used with grease, AQ seals enable maintenance-free operation for a long period.

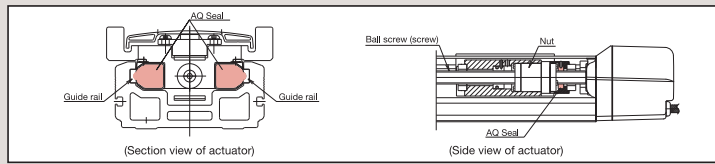
**Brake****Code B**

Description A retention mechanism that prevents the slider from falling and damaging the load when the power or servo is turned off in a vertical actuator application.

Anti-electrostatic Specification**Code ESD**

Description This is the anti-electrostatic specification. The structural parts of the actuator are given electroless nickel-plating to add conductivity, thereby preventing the actuator from being charged with electricity. (Note: Due to plating, the maximum stroke is limited to 1000 mm on the ESD type.)

Reversed Home Specification**Code NM**

Description The standard home direction is on the motor side. To change the home direction, the encoder must be adjusted. Should you require the reverse homing specification, please specify it in your order.

Guide with Ball-retaining Mechanism**Code RT**

Description A spacer (retainer) is inserted between adjacent guide balls (steel balls) to achieve reduced noise and longer life. The spacers eliminate annoying metallic sounds generated by the balls contact with each other. These spacers also reduce the wear of balls caused by mutual friction, consequently extending the service life of the guide. The balls move smoothly without contacting each other, which improves slider mobility.

Suction Duct Joint on Opposite Side (ISDACR, ISPDACR Only)**Code VR**

Description The standard specification comes with the air suction joint on the left side as viewed from the motor. This option changes the joint location to the opposite side, or the right side.

Horizontal Load Capacity by Acceleration Condition (Reference)

* The load capacities shown below are reference figures and not guaranteed. They should be used for reference purposes only.

Type	Motor output (W)	Lead (mm)	Maximum speed (mm/sec)	Rated acceleration (G)	Load capacity at rated acceleration		Maximum acceleration (G)	Load capacity by acceleration								
					(kg)	(G)		0.3G	0.4G	0.5G	0.6G	0.7G	0.8G	0.9G	1.0G	
S	60	16	800	0.3	Horizontal	12	1.0	12	9	7	6	5	4.5	4	3.5	
					Vertical	3	0.7	3	2.5	2.3	2.1	2	-	-	-	-
		8	400	0.3	Horizontal	25	0.6	25	18.5	15	12	-	-	-	-	-
					Vertical	6	0.5	6	5.5	5	-	-	-	-	-	-
		4	200	0.15	Horizontal	50	0.5	50	37.5	30	-	-	-	-	-	-
					Vertical	14	0.3	12	-	-	-	-	-	-	-	-
M	100	20	1000	0.3	Horizontal	20	1.0	20	15	12	10	8.5	7.5	6.5	6	
					Vertical	3.5	0.8	3.5	3.2	2.9	2.7	2.4	2	-	-	-
		10	500	0.3	Horizontal	40	0.6	40	30	24	20	-	-	-	-	
					Vertical	9	0.5	9	7.6	7	-	-	-	-	-	
		5	250	0.15	Horizontal	80	0.5	80	60	45	-	-	-	-	-	
					Vertical	19	0.3	15	-	-	-	-	-	-	-	
	200	20	1000	0.3	Horizontal	40	1.0	40	30	24	20	17	15	13.5	12	
					Vertical	9	0.8	9	7.6	7	6.5	6	5	-	-	
		10	500	0.3	Horizontal	80	0.6	80	60	48.5	40	-	-	-	-	
					Vertical	19	0.5	19	16.3	15	-	-	-	-	-	
MX	200	20	1000	0.3	Horizontal	40	0.3	40	-	-	-	-	-	-		
L	200	20	1000	0.3	Horizontal	40	1.0	40	30	24	20	17	15	13.5	12	
					Vertical	9	0.8	9	6.6	6	5.5	5	4	-	-	
		10	500	0.3	Horizontal	80	0.6	80	60	48.5	40	-	-	-	-	
					Vertical	19	0.5	19	15.3	14	-	-	-	-	-	
		400	20	1000	0.3	Horizontal	80	1.0	80	60	48.5	40.5	34.5	30	27	24
						Vertical	19	0.8	19	15.3	14.1	13.1	12.2	10	-	-
LX	200	20	1000	0.3	Horizontal	40	0.3	40	-	-	-	-	-	-		
	400	20	1000	0.3	Horizontal	80	0.3	80	-	-	-	-	-	-		

• Even if the actual acceleration is below the rated acceleration, the load capacity will not increase beyond the level corresponding to the rated acceleration.

Controller

Program, positioner or pulse-train input type can be selected in accordance with the control method suitable for your application.

* Refer to a separate catalog for the details of each controller.

X-SEL Controller

A high-functional, multi-axis controller supporting Super SEL Language—a programming language that enables easy programming of complex operations.

- [Features]
- Simultaneous control of up to 6 axes
 - Registration of up to 128 programs/20,000 positions
 - Support of both absolute and incremental actuators
 - Compatible with DeviceNet, CC-Link, ProfiBus and Ethernet
 - CE Mark certified



SSELController

A 2-axes positioner that enables easy positioning operation. The SSEL program controller has various control functions combined into a single unit.

- [Features]
- Up to 1,500 positioning points
 - Support of both absolute and incremental actuators and Ethernet
 - With 2 axes, arc interpolation and path operation can be performed



SCON Controller

Position controller capable of 1 axis control.

- [Features]
- Supports up to 512 positioning points
 - DeviceNet, CC-Link specifications (optional)
 - Pulse converter option



Motor Cable/ Encoder Cable

* In , enter a desired cable length (L) up to 30 m. (Example: 080 = 8 m)

Motor Cable (XSEL-J/K/P/Q, SSEL, SCON)

[Model: CB-X-MA□□□]

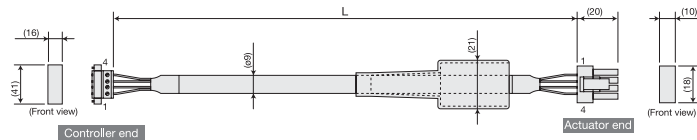

Wiring Diagram

Wire	Color	Signal	No.	No.	Signal	Color	Wire
0.75sq	Green	PE	1	1	U	Red	0.75sq (crimped)
	Red	U	2	2	V	White	
	White	V	3	3	W	Black	
	Black	W	4	4	PE	Green	

Encoder Cable (XSEL-J/K)

[Model: CB-X-PA□□□]

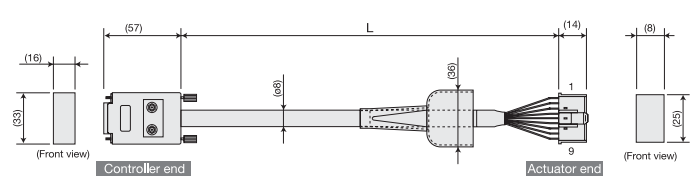

Wiring Diagram

Wire	Color	Signal	No.	No.	Signal	Color	Wire
0.15sq (crimped)	—	—	1	1	BAT+	Black	0.15sq (crimped)
	—	—	2	2	BAT-	Yellow	
	—	—	3	3	SD	Blue	
	—	—	4	4	SD	Orange	
	—	—	5	5	VCC	Green	
	—	—	6	6	GND	Brown	
	Blue	SD	7	7	FG	Gray	
	Orange	SD	8	8	BK+	Red	
	Black	BAT+	9	9	BK-	Gray	
	Yellow	BAT-	10	10	—	—	
	Green	VCC	11	11	—	—	
	Brown	GND	12	12	—	—	
	Gray	BK-	13	13	—	—	
	Red	BK+	14	14	—	—	
	—	—	15	15	—	—	

The shield is clamped to the hood
Braided ground & shield wire

Encoder Cable (XSEL-P/Q, SSEL, SCON)

[Model: CB-X1-PA□□□]

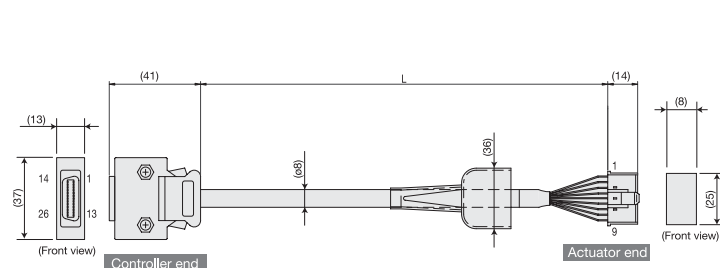

Wiring Diagram

Wire	Color	Signal	No.	No.	Signal	Color	Wire
AWG26 (soldered)	—	—	10	10	BAT+	Purple	AWG26 (crimped)
	—	—	11	11	BAT-	Gray	
	—	E24V	12	12	SD	Orange	
	—	0V	13	13	SD	Green	
	—	LS	26	26	VCC	Red	
	—	CREEP	25	25	GND	Black	
	—	OT	24	24	FG	Gray	
	—	RSV	23	23	BK-	Blue	
	—	—	9	9	BK+	Yellow	
	—	—	18	18	—	—	
	—	—	19	19	—	—	
	—	A+	1	1	—	—	
	—	A-	2	2	—	—	
	—	B+	3	3	—	—	
	—	B-	4	4	—	—	
	—	Z+	5	5	—	—	
	—	Z-	6	6	—	—	
	Orange	SRD+	7	7	—	—	
	Green	SRD-	8	8	—	—	
	Purple	BAT+	14	14	—	—	
	Gray	BAT-	15	15	—	—	
	Red	VCC	16	16	—	—	
Black	VCC	17	17	—	—		
Blue	BKR-	20	20	—	—		
Yellow	BKR+	21	21	—	—		
—	—	22	22	—	—		

The shield is clamped to the hood
Braided ground & shield wire