

Filter Cards

Filter Cards for Single Phase Loads:
Brushed Motors, Voice Coils, and other Single Phase Loads

Model Number	Inductance Line to Line	Continuous Current	Voltage Rating
FC1010	20 μ H	10A	200V
FC10010	200 μ H	10A	250V
FC15030	300 μ H	30A	400V

Filter Cards for Three Phase Loads:
Brushless Motors, Linear Motors, and other Three Phase Loads

BFC1010	20 μ H	10A	200V
BFC10010	200 μ H	10A	250V
BFC15030	300 μ H	30A	400V
BFC15030800	300 μ H	30A	800V

FC1010

FC10010

FC15030

BFC1010

BFC10010

BFC15030

BFC15030800
Description

The FC and BFC series of filter cards have been designed to complement **ADVANCED Motion Controls'** servo drives. These filters contain two inductors for single phase loads and three inductors for three phase loads.

Inductive filter cards have two typical applications:

1. **To increase the inductance to meet the minimum load inductance requirement of *ADVANCED Motion Controls* servo drives.**

Some motors have inductances that are less than the minimum load inductance requirement for the servo drive. For example, "basket-wound" and "pancake" motors do not have a conventional iron core rotor so the winding inductance is usually less than 25 μ H. For this type of application the filter card should be sized so the total inductance of the motor plus filter card meets or exceeds the inductance requirements of the servo drive. The filter card must also be rated to the required current.

2. **To reduce the DV/DT of the motor outputs.**

The main source of emitted drive noise is the high DV/DT (typically about 1V/nanosecond) of the drive's output power stage. Unfiltered motor outputs can introduce noise in digital encoder signals. For applications with noise sensitive devices (e.g. video cameras, magnetic/capacitive sensors) the use of an external inductive filter card may reduce emitted noise.

Note: Most applications do not require external filters.

Features

- ▲ Increases Load Inductance
- ▲ Small Size, Low Cost, Ease of Use
- ▲ Provides Dramatic Noise Reduction

Agency Approvals

US and Canadian safety compliance with UL 508c, the industrial standard for power conversion electronics. UL registered under file number E140173. Note that machine components compliant with UL are considered UL registered as opposed to UL listed, as would be the case for commercial products.



Compliant with European CE for both the Class A EMC Directive 2004/108/EC on Electromagnetic Compatibility (specifically EN 61000-6-4:2007 and EN 61000-6-2:2005) and LVD requirements of directive 2006/95/EC (specifically EN 60204-1:2006), a low voltage directive to protect users from electrical shock.



RoHS (Reduction of Hazardous Substances) is intended to prevent hazardous substances such as lead from being manufactured in electrical and electronic equipment.

SPECIFICATIONS

Power Specifications								
Description	Units	FC1010	FC10010	FC15030	BFC1010	BFC10010	BFC15030	BFC15030800
Inductance (Line to Line)	μH	20	200	300	20	200	300	300
Continuous Current	A	10	10	30	10	10	30	30
Voltage Rating	VDC	200	250	400	200	250	400	800
Capacitance (C)	μF	-	.01	.068	-	.01	-	-
Mechanical Specifications								
Description	Units	FC1010	FC10010	FC15030	BFC1010	BFC10010	BFC15030	BFC15030800
Connector	-	Screw Terminals						
Size (HxWxD)	mm (in)	56.5x28.0x15.8 (2.23x1.10x0.62)	65.3x51.3x25.7 (2.57x2.02x1.01)	101.6x88.9x44.5 (4.00x3.5x1.75)	56.5x28.6x15.8 (2.23x1.13x0.62)	65.3x64.8x25.7 (2.57x2.55x1.01)	134.6x113.7x43.5 (5.30x4.48x1.71)	173.7x113.7x52.4 (6.84x4.48x2.06)
Weight	kg (lbs)	0.027 (0.06)	0.14 (0.32)	0.95 (2.1)	0.037 (0.08)	0.21 (0.46)	1.43 (3.16)	1.63 (3.60)
Operating Temperature Range	°C (°F)	-40 - 75 (-40 - 167)						

BLOCK DIAGRAM

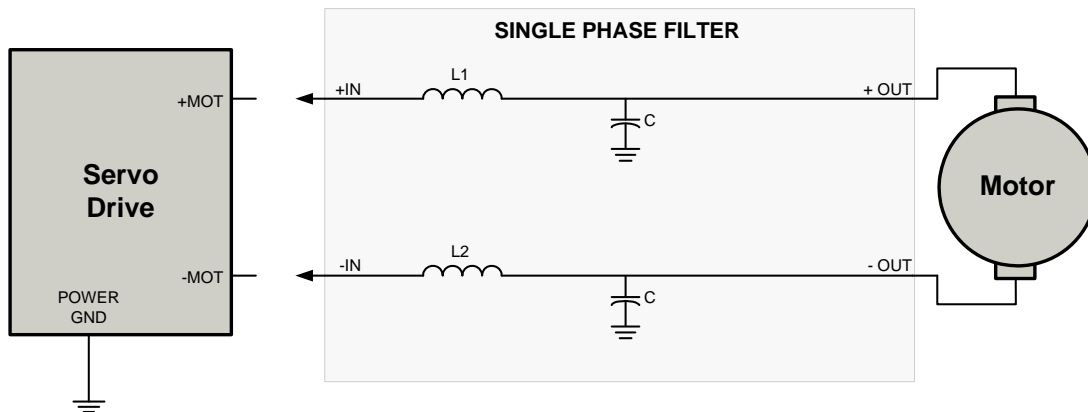
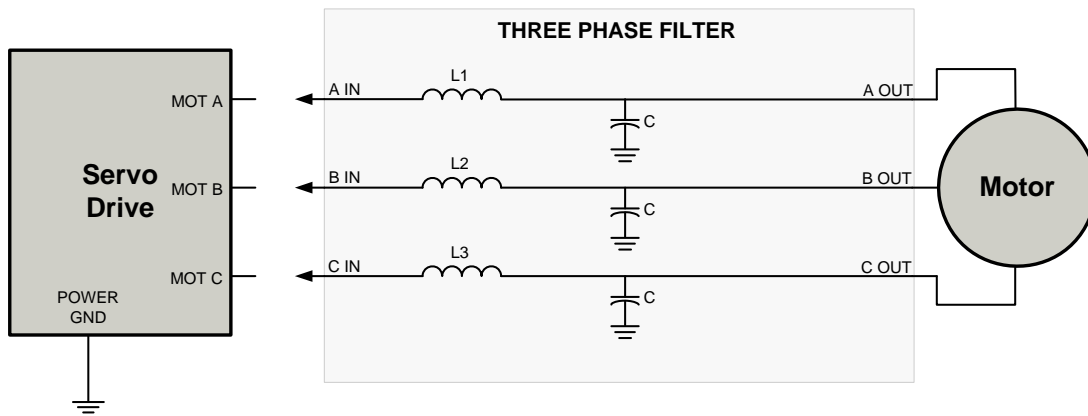

NOTE: Capacitor is not used on all models. See Specifications above for applicable capacitance values

MOUNTING DIMENSIONS

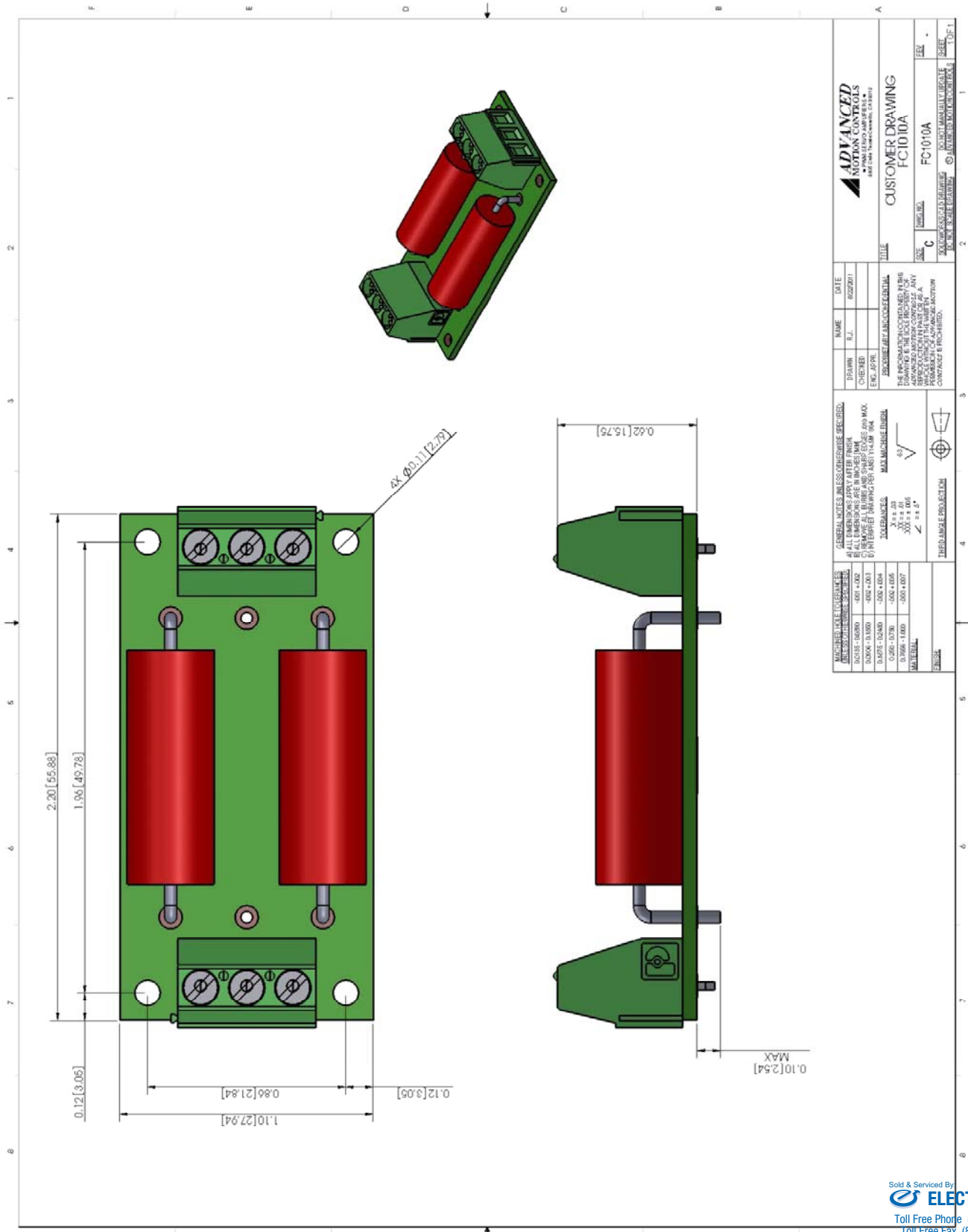

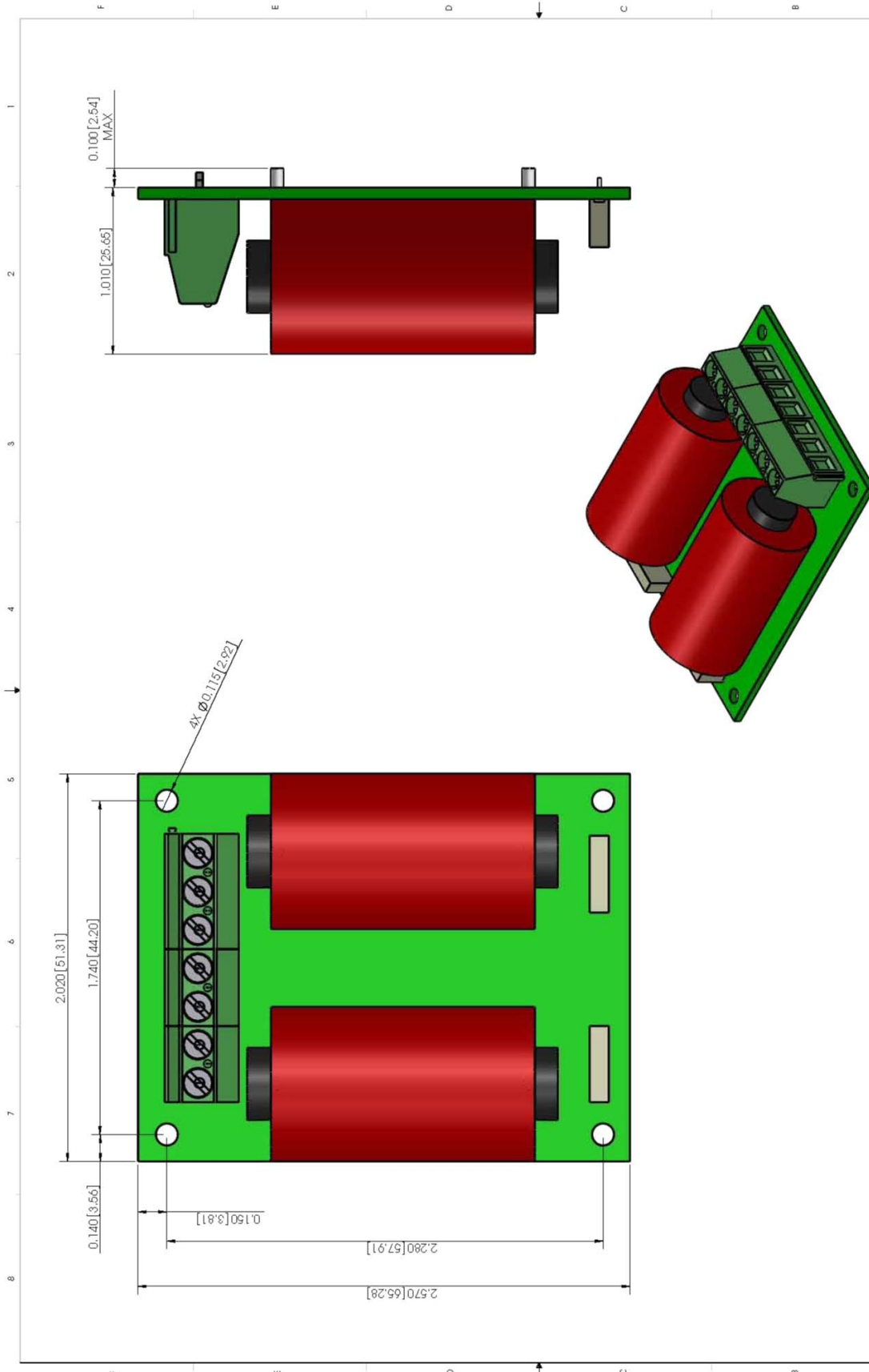

ADVANCED MOTION CONTROLS PANEL SERVO AMPLIFIERS AND CNC TRANSDUCER OUTPUT		NAME: _____ DATE: 02/27/01
DRAWN: _____ CHECKED: _____ ENG. APPR: _____	TITLE: CUSTOMER DRAWING FC:10010	SIZE: C SHEET: 1 OF 1
GENERAL NOTES: UNLESS OTHERWISE SPECIFIED: A) DIMENSIONS ARE IN INCHES UNLESS OTHERWISE SPECIFIED. B) ALL DIMENSIONS ARE IN INCHES UNLESS OTHERWISE SPECIFIED. C) REMOVE ALL BURRS AND SHARP EDGES, 0.00 MAX. D) IN FEATURES DIMENSIONS PER FIRST THRU LAST DIMENSION.		
DIMENSIONS: REAL MACHINE FINISH .005 ± .006 .008 ± .006 .010 ± .006 .015 ± .006 .020 ± .006 .030 ± .006 .040 ± .006 .050 ± .006 .060 ± .006 .070 ± .006 .080 ± .006 .090 ± .006 .100 ± .006 .120 ± .006 .150 ± .006 .200 ± .006 .250 ± .006 .300 ± .006 .375 ± .006 .500 ± .006 .750 ± .006 1.000 ± .006 1.500 ± .006 2.000 ± .006 3.000 ± .006 4.000 ± .006 5.000 ± .006 6.000 ± .006 7.000 ± .006 8.000 ± .006 9.000 ± .006 10.000 ± .006 12.000 ± .006 15.000 ± .006 20.000 ± .006 25.000 ± .006 30.000 ± .006 37.500 ± .006 50.000 ± .006 75.000 ± .006 100.000 ± .006 125.000 ± .006 150.000 ± .006 200.000 ± .006 250.000 ± .006 300.000 ± .006 375.000 ± .006 500.000 ± .006 750.000 ± .006 1000.000 ± .006		
FINISH: _____ TOLERANCE PROJECTION: _____		

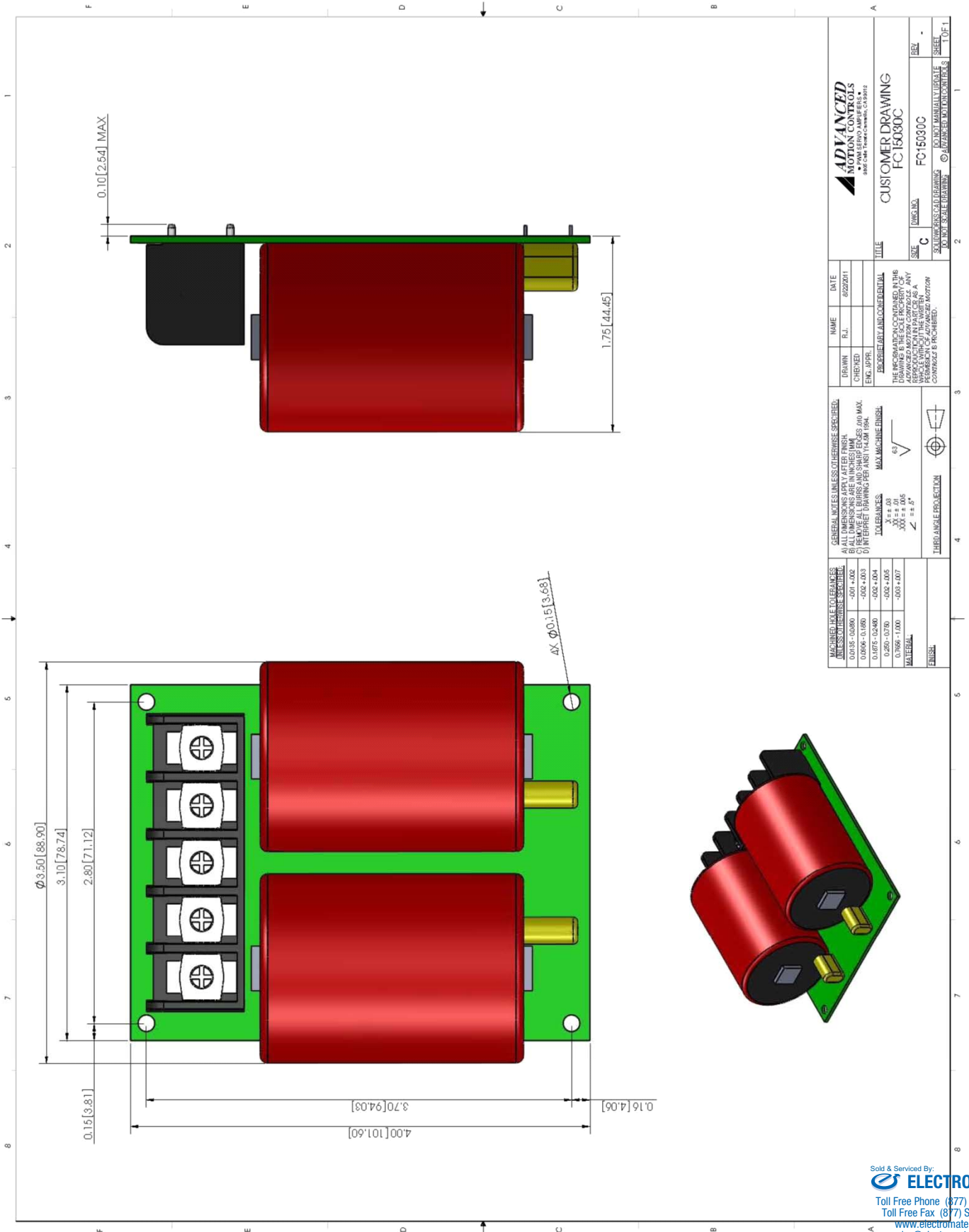

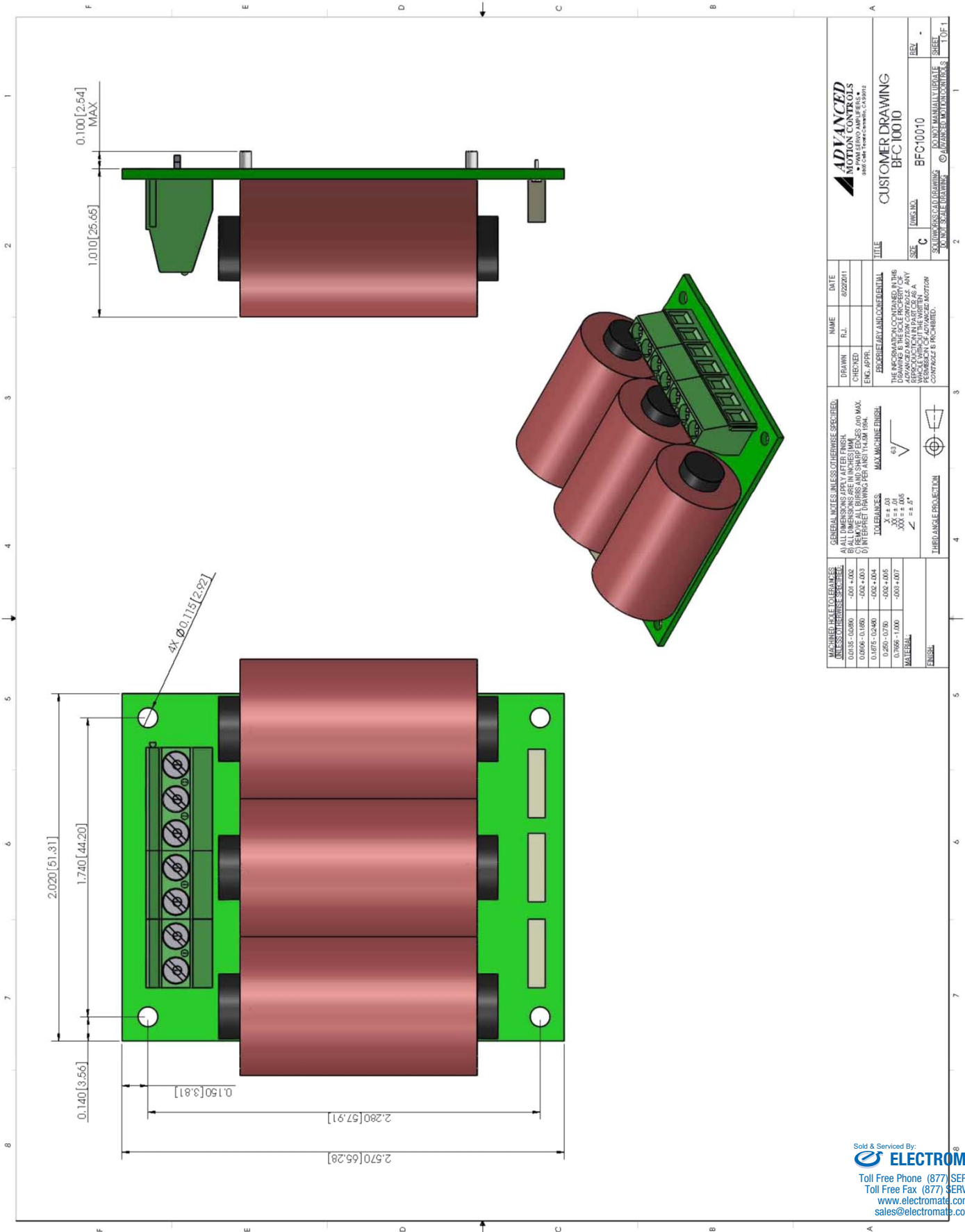

ADVANCED MOTION CONTROLS 3800 GARDEN STREET • SANTA ANA, CA 92704		NAME	DATE
DRAWN	R.L.	8/22/2011	
CHECKED			
ENG. APPR.			
PROPERTIES AND COORDINATES THE INFORMATION CONTAINED HEREIN IS THE PROPERTY OF ADVANCED MOTION CONTROLS. ANY REPRODUCTION OR TRANSMISSION IN ANY FORM OR BY ANY MEANS WITHOUT THE WRITTEN CONSENT OF ADVANCED MOTION CONTROLS IS PROHIBITED.		TITLE CUSTOMER DRAWING BFC10010	
SIZE	DWG. NO.	REV.	SHEET
C	BFC10010		1 OF 1
SOURCE: CUSTOMER DRAWING © ADVANCED MOTION CONTROLS		SOURCE: SCALE DRAWING © ADVANCED MOTION CONTROLS	

MACHINABLE TOLERANCES UNLESS OTHERWISE SPECIFIED: 0.0135 - 0.0800 -001 +002 0.0806 - 0.1600 -002 +003 0.1675 - 0.2480 -002 +004 0.250 - 0.750 -002 +005 0.7506 - 1.000 -003 +007	GENERAL NOTES UNLESS OTHERWISE SPECIFIED: (A) ALL DIMENSIONS APPLY AFTER FINISH (B) ALL DIMENSIONS ARE IN INCHES UNLESS MAX. 640 MAX. (C) DIMENSIONS ARE TO CENTER UNLESS OTHERWISE NOTED (D) INTERPRET DRAWINGS PER ANSI Y14.5M 1994.	TOLERANCES: MAX. MACHINE FINISH X ± 0.03 Y ± 0.01 Z ± 0.01 A ± 0.01 B ± 0.01 C ± 0.01 D ± 0.01 E ± 0.01 F ± 0.01 G ± 0.01 H ± 0.01 I ± 0.01 J ± 0.01 K ± 0.01 L ± 0.01 M ± 0.01 N ± 0.01 O ± 0.01 P ± 0.01 Q ± 0.01 R ± 0.01 S ± 0.01 T ± 0.01 U ± 0.01 V ± 0.01 W ± 0.01 X ± 0.01 Y ± 0.01 Z ± 0.01	FINISH: THREANGLE PROJECTION
---	--	--	---------------------------------

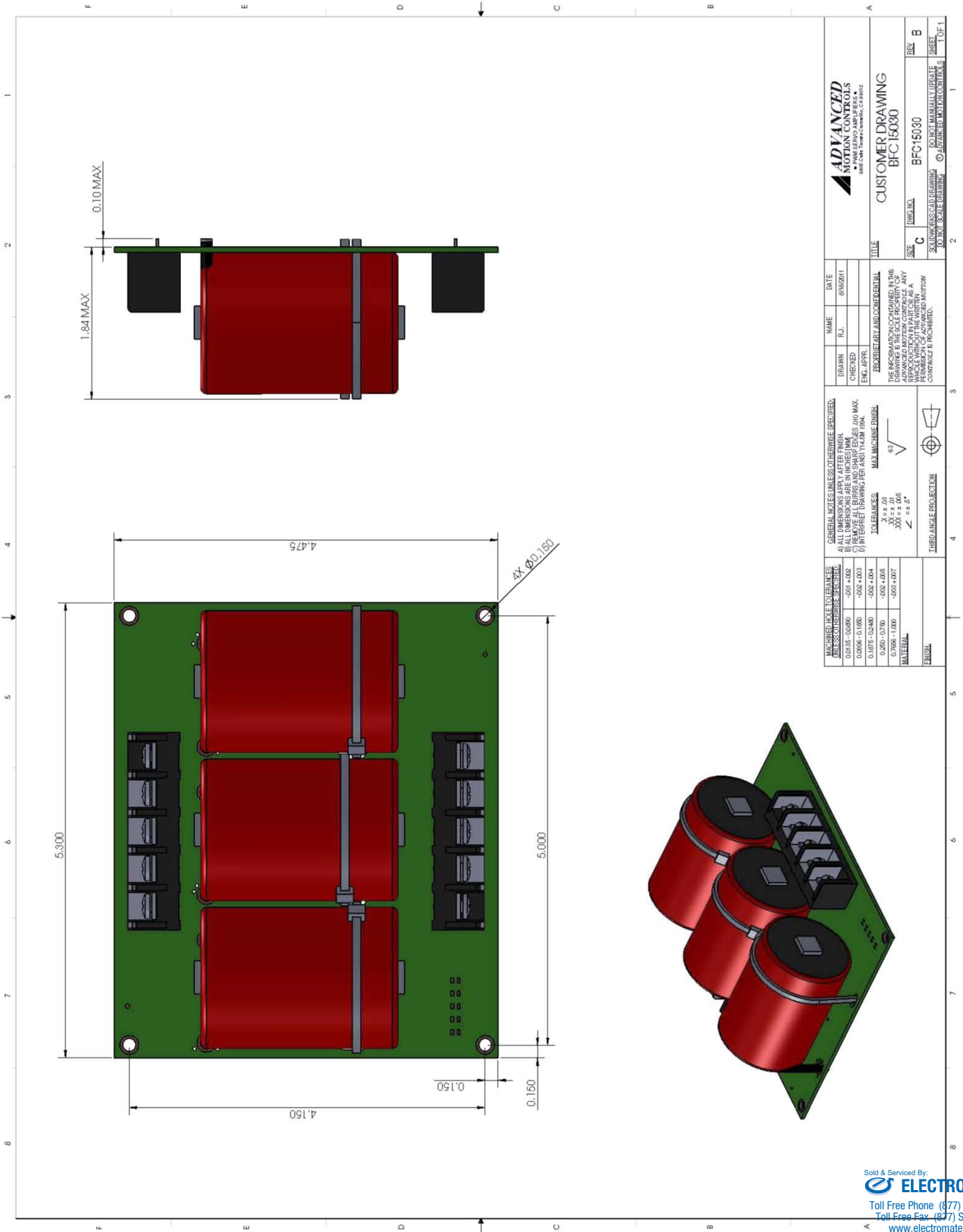

ADVANCED
MOTION CONTROLS
880 ONE TREE CIRCLE, CA 94015

CUSTOMER DRAWING
BFC-15030

UNGS. NO. BFC-15030

REV. B

DO NOT SCALE DRAWING
SOLIDWORKS CAD DRAWINGS
© ADVANCED MOTION CONTROLS

1 OF 1

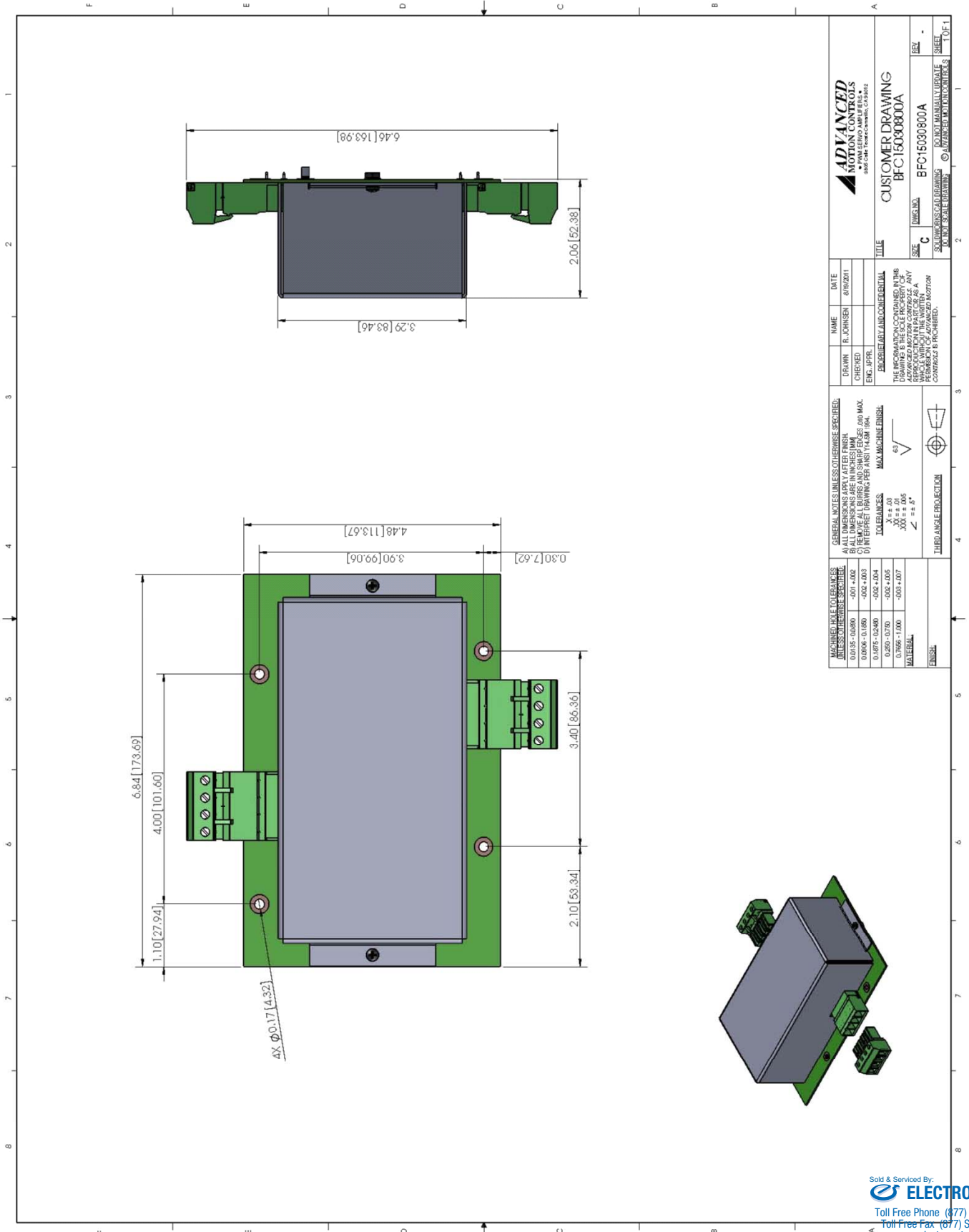

<p>ADVANCED MOTION CONTROLS 10000 LINDEN DRIVE MILWAUKEE, WI 53222 800-541-7469</p>		<p>CUSTOMER DRAWING BFC16030800A</p>	
<p>DATE: 8/18/2011</p>	<p>NAME: R. JOHNSON</p>	<p>DRAWN BY: R. JOHNSON</p>	<p>TITLE: CUSTOMER DRAWING</p>
<p>CHECKED BY: ENC. J.P.P.R.</p>	<p>DESIGNED BY: R. JOHNSON</p>	<p>SIZE: C</p>	<p>DWG. NO.: BFC16030800A</p>
<p>GENERAL NOTE: UNLESS OTHERWISE SPECIFIED: A) ALL DIMENSIONS APPLY AFTER FINISH. B) DIMENSIONS ARE TO CENTER UNLESS OTHERWISE SPECIFIED. C) DIMENSIONS ARE TO CENTER UNLESS OTHERWISE SPECIFIED. D) INTERFERE WITH PER ANSI Y14.4M 1994.</p>		<p>THE INFORMATION CONTAINED IN THIS DRAWING IS THE SOLE PROPERTY OF ADVANCED MOTION CONTROLS. ANY REPRODUCTION IN WHOLE OR IN PART WITHOUT THE WRITTEN PERMISSION OF ADVANCED MOTION CONTROLS IS PROHIBITED.</p>	
<p>FINISH: 63/</p>	<p>TOLERANCES: X ± .03 Y ± .05 Z ± .05</p>	<p>MAX. MACHINE FINISH</p>	<p>THIRD ANGLE PROJECTION</p>
<p>MACHINING TOLERANCES: 0.015 - 0.060 -0.01 +0.02 0.060 - 0.180 -0.02 +0.03 0.180 - 0.240 -0.02 +0.04 0.250 - 0.750 -0.02 +0.05 0.750 - 1.000 -0.03 +0.07</p>	<p>ANGLES: 63/</p>	<p>ANGLES: 63/</p>	<p>ANGLES: 63/</p>
<p>DO NOT SCALE DRAWING</p>		<p>DO NOT MANUALLY UPGRADE SHEET</p>	
<p>1 OF 1</p>		<p>1 OF 1</p>	

CUSTOMIZATION INFORMATION

ADVANCED Motion Controls' products are available in many configurations. All models listed in the selection tables of the website are readily available, standard product offerings.

ADVANCED Motion Controls also has the capability to promptly develop and deliver specified products for OEMs with volume requests. Our Applications and Engineering Departments will work closely with your design team through all stages of development in order to provide the best servo drive solution for your system. Equipped with on-site manufacturing for quick-turn customs capabilities, ADVANCED Motion Controls utilizes our years of engineering and manufacturing expertise to decrease your costs and time-to-market while increasing system quality and reliability. Feel free to contact Applications Engineering for further information and details.

Examples of Customized Products

- | | |
|--------------------------------|-----------------------------------|
| ▲ Optimized Footprint | ▲ Tailored Project File |
| ▲ Private Label Software | ▲ Silkscreen Branding |
| ▲ OEM Specified Connectors | ▲ Optimized Base Plate |
| ▲ No Outer Case | ▲ Increased Current Limits |
| ▲ Increased Current Resolution | ▲ Increased Voltage Range |
| ▲ Increased Temperature Range | ▲ Conformal Coating |
| ▲ Custom Control Interface | ▲ Multi-Axis Configurations |
| ▲ Integrated System I/O | ▲ Reduced Profile Size and Weight |

Available Accessories

ADVANCED Motion Controls offers a variety of accessories designed to facilitate drive integration into a servo system. Visit www.a-m-c.com to see which accessories will assist with your application design and implementation.

