

**Description**

The DZSANTU-020B200 digital servo drive is designed to drive brushed and brushless servomotors from a compact form factor ideal for embedded applications. This fully digital drive operates in torque, velocity, or position mode and employs Space Vector Modulation (SVM), which results in higher bus voltage utilization and reduced heat dissipation compared to traditional PWM. The drive can be configured for a variety of external command signals. Commands can also be configured using the drive's built-in Motion Engine, an internal motion controller used with distributed motion applications. In addition to motor control, this drive features dedicated and programmable digital and analog inputs and outputs to enhance interfacing with external controllers and devices.

The DZSANTU-020B200 supports *ADVANCED* Motion Controls exclusive 'DxM' technology which allows connectivity of up to 3 DZSANTU-020B200 drives to a single DZEANTU-020B200 on an EtherCAT® network. DZSANTU-020B200 drives receive commands from a DZEANTU-020B200 over a high speed communication interface, allowing for up to 4 axes of servo drive control from a single EtherCAT connection. Drive commissioning and setup is accomplished through a USB interface using DriveWare® 7, available for download at [www.a-m-c.com](http://www.a-m-c.com).

All drive and motor parameters are stored in non-volatile memory.

**Power Range**

Peak Current	20 A (14.1 A <sub>RMS</sub> )
Continuous Current	10 A (10 A <sub>RMS</sub> )
Supply Voltage	40 - 175 VDC

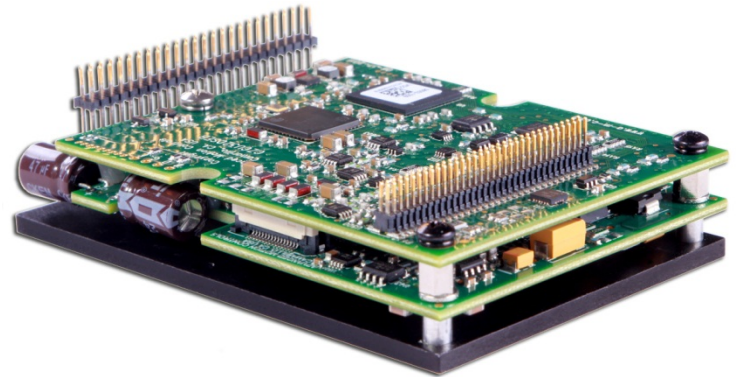

**Features**

- ▲ Four Quadrant Regenerative Operation
- ▲ Space Vector Modulation (SVM) Technology
- ▲ Fully Digital State-of-the-art Design
- ▲ Programmable Gain Settings
- ▲ Fully Configurable Current, Voltage, Velocity and Position Limits
- ▲ PIDF Velocity Loop
- ▲ PID + FF Position Loop
- ▲ Compact Size, High Power Density
- ▲ 12-bit Analog to Digital Hardware
- ▲ Supports *ADVANCED* Motion Controls 'DxM' Technology
- ▲ On-the-Fly Mode Switching
- ▲ On-the-Fly Gain Set Switching

**MODES OF OPERATION**

- Profile Current
- Profile Velocity
- Profile Position
- Cyclic Synchronous Current Mode
- Cyclic Synchronous Velocity Mode
- Cyclic Synchronous Position Mode

**COMMAND SOURCE**

- Over the Network

**FEEDBACK SUPPORTED (FIRMWARE DEPENDENT)**

- Halls
- Incremental Encoder
- Auxiliary Incremental Encoder
- 1Vp-p Sine/Cosine Encoder (see note 5 on page 3)
- Absolute Encoder (Heidenhain EnDat® or Stegmann Hiperface®)
- ±10 VDC Position
- Tachometer (±10 VDC)

**INPUTS/OUTPUTS**

- 1 Programmable Analog Input (12-bit Resolution)
- 5 Programmable Digital Inputs (Differential)
- 3 Programmable Digital Inputs (Single-Ended)
- 5 Programmable Digital Outputs (Single-Ended)
- 3 High Speed Captures



**COMPLIANCES & AGENCY APPROVALS**

- UL
- cUL
- CE Class A (LVD)
- CE Class A (EMC)
- RoHS

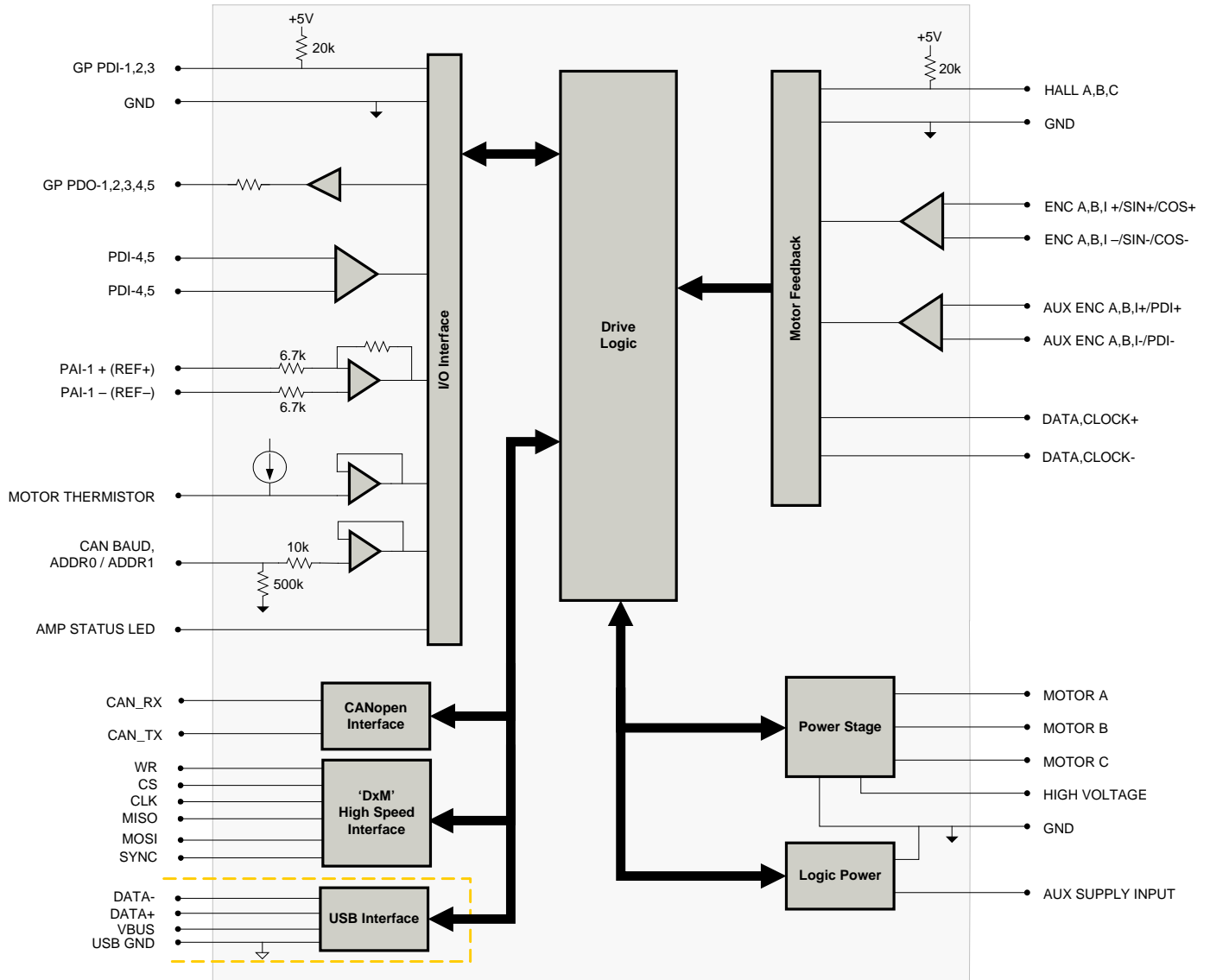
**BLOCK DIAGRAM**



**Information on Approvals and Compliances**

	<p>US and Canadian safety compliance with UL 508c, the industrial standard for power conversion electronics. UL registered under file number E140173. Note that machine components compliant with UL are considered UL registered as opposed to UL listed as would be the case for commercial products.</p>
	<p>Compliant with European CE for both the Class A EMC Directive 2004/108/EC on Electromagnetic Compatibility (specifically EN 61000-6-4:2007 and EN 61000-6-2:2005) and LVD requirements of directive 2006/95/EC (specifically EN 60204-1:2006), a low voltage directive to protect users from electrical shock.</p>
	<p>RoHS (Reduction of Hazardous Substances) is intended to prevent hazardous substances such as lead from being manufactured in electrical and electronic equipment.</p>

**SPECIFICATIONS**

Description	Power Specifications		Value
	Units		
DC Supply Voltage Range	VDC	40 - 175	
DC Bus Over Voltage Limit	VDC	190	
DC Bus Under Voltage Limit	VDC	37	
Logic Supply Voltage	VDC	40 - 175	
Maximum Peak Output Current <sup>1</sup>	A (Arms)	20 (14.1)	
Maximum Continuous Output Current <sup>2</sup>	A (Arms)	10 (10)	
Maximum Continuous Output Power	W	1663	
Maximum Power Dissipation at Continuous Current	W	88	
Internal Bus Capacitance <sup>3</sup>	µF	145	
Minimum Load Inductance (Line-To-Line) <sup>4</sup>	µH	250	
Switching Frequency	kHz	20	
Maximum Output PWM Duty Cycle	%	92	

Description	Control Specifications		Value
	Units		
Communication Interfaces	-	'DxM' High Speed Interface (USB for configuration)	
Command Sources	-	Over the Network	
Feedback Supported (Firmware Dependent) <sup>5</sup>	-	Auxiliary Incremental Encoder, Halls, Incremental Encoder, 1Vp-p Sine/Cosine Encoder, Absolute Encoder (Heidenhain EnDat® or Stegmann Hiperface®), ±10 VDC Position, Tachometer (±10 VDC)	
Commutation Methods	-	Sinusoidal, Trapezoidal	
Modes of Operation	-	Profile Current, Profile Velocity, Profile Position, Cyclic Synchronous Current, Cyclic Synchronous Velocity, Cyclic Synchronous Position	
Motors Supported	-	Closed Loop Vector, Single Phase (Brushed, Voice Coil, Inductive Load), Three Phase (Brushless)	
Hardware Protection	-	40+ Configurable Functions, Over Current, Over Temperature (Drive & Motor), Over Voltage, Short Circuit (Phase-Phase & Phase-Ground), Under Voltage	
Programmable Digital Inputs/Outputs (PDIs/PDOs)	-	8/5	
Programmable Analog Inputs/Outputs (PAIs/PAOs)	-	1/0	
Primary I/O Logic Level	-	5V TTL	
Current Loop Sample Time	µs	50	
Velocity Loop Sample Time	µs	100	
Position Loop Sample Time	µs	100	
Maximum Encoder Frequency	MHz	20 (5 pre-quadrature)	

Description	Mechanical Specifications		Value
	Units		
Agency Approvals	-	CE Class A (EMC), CE Class A (LVD), cUL, RoHS, UL	
Size (H x W x D)	mm (in)	88.9 x 63.5 x 20.1 (3.5 x 2.5 x 0.8)	
Weight	g (oz)	125.8 (4.43)	
Baseplate Operating Temperature Range <sup>6</sup>	°C (°F)	0 - 75 (32 - 167)	
Storage Temperature Range	°C (°F)	-20 - 85 (-4 - 185)	
Relative Humidity	-	0 - 90% non-condensing	
Altitude	m (ft)	0 - 4000 (0 - 13123)	
Cooling System	-	Natural Convection	
Form Factor	-	PCB Mounted	
P1 Connector	-	68-pin, 1.27 mm spaced, dual-row header	
P2 Connector	-	50-pin, 2.0 mm spaced, dual-row header	

**Notes**

1. Capable of supplying drive rated peak current for 2 seconds with 10 second foldback to continuous value. Longer times are possible with lower current limits.
2. Continuous  $A_{rms}$  value attainable when RMS Charge-Based Limiting is used.
3. Additional 100 µF / 200V external bus capacitor is required.
4. Lower inductance is acceptable for bus voltages well below maximum. Use external inductance to meet requirements.
5. Contact *ADVANCED* Motion Controls for 1Vp-p Sine/Cosine Encoder feedback availability.
6. Additional cooling and/or heatsink is required to achieve rated performance.

**PIN FUNCTIONS**

P1 - Signal Connector				P1 - Signal Connector			
Pin	Name	Description / Notes	I/O	Pin	Name	Description / Notes	I/O
1	RESERVED	Reserved. Do not connect.	-	2	CAN BAUD	CAN Bus Bit Rate Selector	I
3	PAI-1-	Differential Programmable Analog Input or Reference Signal Input (12-bit Resolution)	I	4	ADDR1	CAN Bus Address Selector	I
5	PAI-1+		I	6	ADDR0		I
7	GROUND	Ground	GND	8	GROUND	Ground	GND
9	MOT ENC B- / COS-	Primary Incremental Encoder or Cos Input from feedback device (Absolute or Sin/Cos 1Vp-p)	I	10	MOT ENC A- / SIN-	Primary Incremental Encoder or Sin Input from feedback device (Absolute or Sin/Cos 1Vp-p)	I
11	MOT ENC B+ / COS+		I	12	MOT ENC A+ / SIN+		I
13	GROUND	Ground	GND	14	+5V OUT	+5V User Supply	O
15	MOTOR THERMISTOR	Motor Thermistor Input	I	16	GROUND	Ground	GND
17	MOT ENC CLK-	Serial Interface (RS485) for absolute feedback device	I/O	18	MOT ENC DATA-	Serial Interface (RS485) for absolute feedback device	I/O
19	MOT ENC CLK+		I/O	20	MOT ENC DATA+		I/O
21	MOT ENC I-	Differential Incremental Encoder Channel I	I	22	AUX ENC B-	Auxiliary Incremental Encoder Channel B or Differential Programmable Digital Input 7	I
23	MOT ENC I+		I	24	AUX ENC B+		I
25	AUX ENC I-	Auxiliary Incremental Encoder Channel I or Differential Programmable Digital Input 8	I	26	AUX ENC A-	Auxiliary Incremental Encoder Channel A or Differential Programmable Digital Input 6	I
27	AUX ENC I+		I	28	AUX ENC A+		I
29	+5V OUT	+5V User Supply	O	30	HALL B	Single-ended Commutation Sensor Inputs	I
31	HALL C	Single-ended Commutation Sensor Inputs	I	32	HALL A		I
33	PDI5-	Differential Programmable Digital Input (High Speed Capture)	I	34	PDI4-	Differential Programmable Digital Input (High Speed Capture)	I
35	PDI5+		I	36	PDI4+		I
37	GP PDO-5	General Purpose Programmable Digital Output	O	38	GP PDI-3	General Purpose Programmable Digital Input (High Speed Capture)	I
39	GP PDO-4	General Purpose Programmable Digital Output	O	40	GP PDI-2	General Purpose Programmable Digital Input	I
41	GP PDO-3	General Purpose Programmable Digital Output	O	42	GP PDI-1	General Purpose Programmable Digital Input	I
43	GP PDO-2	General Purpose Programmable Digital Output	O	44	AMP STATUS LED-	AMP Status LED Output for Bi-Color LED	O
45	GP PDO-1	General Purpose Programmable Digital Output	O	46	AMP STATUS LED+		O
47	RESERVED	Reserved. Do not connect.	-	48	RESERVED	Reserved. Do not connect.	-
49	+5V USB	USB Supply	O	50	DATA- USB	USB Data Channel	I/O
51	GND USB	USB Ground	UGND	52	DATA+ USB		I/O
53	GROUND	Ground	GND	54	GROUND	Ground	GND
55	RESERVED	Reserved. Do not connect.	-	56	CAN_LOW	CAN_L bus line (dominant low)	I/O
57	RESERVED		-	58	CAN_HIGH	CAN_H bus line (dominant high)	I/O
59	GROUND	Ground	GND	60	WR	'DxM' Sub-Node High Speed Comm Channel	I/O
61	RESERVED	Reserved. Do not connect.	-	62	CS		I/O
63	SYNC	'DxM' Sub-Node High Speed Comm Channel	I/O	64	CLK		I/O
65	MISO	'DxM' Sub-Node High Speed Comm Channel	I/O	66	MOSI		I/O
67	GROUND	Ground	GND	68	GROUND	Ground	GND

P2 - Power Connector			
Pin	Name	Description / Notes	I/O
1	AUX SUPPLY INPUT	Auxiliary Supply Input for Logic backup (Optional)	I
2	AUX SUPPLY INPUT		I
3-10	HIGH VOLTAGE	DC Power Input	I
11	NC	Not Connected	-
12	NC	Not Connected	-
13-20	GROUND	Ground connection for input power	GND
21	NC	Not Connected	-
22	NC	Not Connected	-
23-30	MOTOR A	Motor Phase A. 3A Continuous Current Rating Per Pin.	O
31	NC	Not Connected	-
32	NC	Not Connected	-
33-40	MOTOR B	Motor Phase B. 3A Continuous Current Rating Per Pin.	O
41	NC	Not Connected	-
42	NC	Not Connected	-
43-50	MOTOR C	Motor Phase C. 3A Continuous Current Rating Per Pin.	O

## Pin Details

*ADDR0 (P1-6); ADDR1 (P1-4)*

*ADDR0*, as well as *ADDR1*, are used to set the DZSANTU drive address on the EtherCAT network.

DZSANTU drives are designed to support 'DxM' technology where up to three DZSANTU drives connect to a single DZEANTU drive over high speed communication channels (A, B, and C). For proper operation in this configuration, the correct voltages need to be applied to *ADDR0* and *ADDR1*, depending on which channel the DZSANTU is connected to. The values are given in the table below.

DZEANTU Connection	ADDR1 Voltage (Volts)	ADDR1 Value (Hex)	ADDR0 Voltage (Volts)	ADDR0 Value (Hex)	Node ID (Decimal)
Channel A	0	0	0.2	1	001
Channel B	0	0	0.4	2	002
Channel C	0	0	0.6	3	003

*CAN BAUD (P1-2)*

DZSANTU drives are required to use the bitrate stored in non-volatile memory (set to 1 Mbit/s). Short the *CAN BAUD* pin to ground to use this setting.

**Note that DZSANTU drives used with the MC4XDZP01 mounting card in a 'DxM' technology configuration will automatically be assigned addresses of 1, 2, and 3, and a bitrate of 1 Mbit/s. No action is required in this configuration to set the addresses and bitrate for the DZSANTU drive(s).**

**MECHANICAL INFORMATION**

**P1 - Signal Connector**

Connector Information		68-pin, 1.27mm spaced, dual-row header
Mating Connector	Details	Samtec: CLP-134-02-F-D-BE-A-K
	Included with Drive	No

**P2 - Power Connector**

Connector Information		50-pin, 2.0mm spaced, dual-row header
Mating Connector	Details	Samtec: CLT-125-02-F-D-BE-A-K
	Included with Drive	No

**MOUNTING DIMENSIONS**

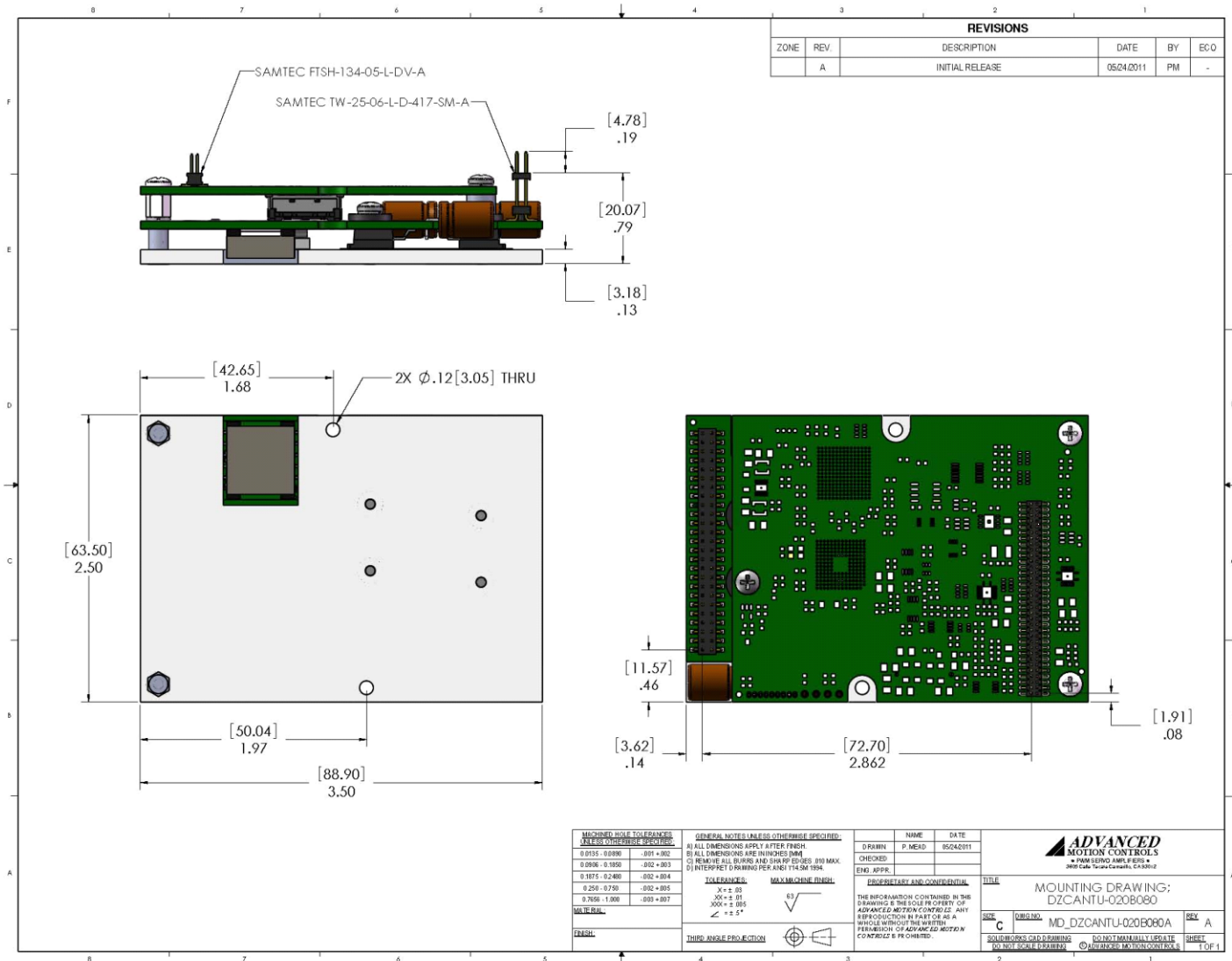

<b>MACHINED HOLE TOLERANCES:</b> (SEE DIMENSIONS SPECIFIC)		<b>GENERAL NOTES (UNLESS OTHERWISE SPECIFIED):</b> A) ALL DIMENSIONS APPLY AFTER FINISH B) ALL DIMENSIONS ARE IN INCHES (MM) C) REMOVE ALL BURRS AND SHARP EDGES (R10 MAX) D) INTERPRET DRAWING PER ANSI Y14.5M 1994		NAME: _____ DATE: _____ DRAWN: P. MEAD 05/24/2011 CHECKED: _____ ENG. APPROV: _____		ADVANCED MOTION CONTROLS 1700 S. RIVER BLVD. # 100 SANTA ANA, CA 92705	
0.0150 - 0.0300    .005 ± .002 0.0300 - 0.1850    .002 ± .003 0.1875 - 0.2400    .002 ± .004 0.2500 - 0.7500    .002 ± .005 0.7500 - 1.0000    .003 ± .007	<b>TOLERANCES:</b> X ± .03 .00 ± .01 .000 ± .005 ∠ ± .5°		<b>MAX MACHINE FINISH:</b> 63		<b>PROPRIETARY AND CONFIDENTIAL</b> THE INFORMATION CONTAINED IN THIS DRAWING IS THE SOLE PROPERTY OF ADVANCED MOTION CONTROLS. ANY REPRODUCTION IN PART OR AS A WHOLE WITHOUT THE WRITTEN PERMISSION OF ADVANCED MOTION CONTROLS IS PROHIBITED.		
<b>FINISH:</b> _____ <b>THIS ANGLE PROJECTION:</b>	<b>TITLE:</b> MOUNTING DRAWING; DZCANTU-020B00A		<b>SIZE:</b> C <b>UNITS:</b> MD_DZCANTU-020B00A <b>SEL:</b> A		SOLIDWORKS CAD DRAWING    DO NOT MANUALLY EDIT DO NOT SCALE DRAWING    © ADVANCED MOTION CONTROLS		



**PART NUMBERING INFORMATION**

Example:

**D Z S A N T U - 0 2 0 B 2 0 0**

<b>Drive Series</b>	
DZ	DigiFlex Z (PCB Mount)
<b>Communication</b>	
C	CANopen Stand-Alone
E	EtherCAT Host
S	EtherCAT Sub-node
<b>Command Inputs</b>	
AN	Analog (±10V) No Step & Direction
<b>Digital I/O</b>	
T	TTL (5V) Non-Isolated
<b>Motor Feedback</b>	
U	Universal (Halls, Inc. Enc., Abs. Enc., 1Vp-p Sin/Cos Enc.)

<b>Max DC Bus Voltage (V<sub>DC</sub>)</b>	
080	80
200	175
<b>Power and Logic Supply</b>	
B	DC Input Both Logic Supply Options (Internal or User)
<b>Peak Current (A<sub>0</sub> to Peak)</b>	
020	20
040	40

DigiFlex® Performance™ series of products are available in many configurations. Note that not all possible part number combinations are offered as standard drives. All models listed in the selection tables of the website are readily available, standard product offerings.

ADVANCED Motion Controls also has the capability to promptly develop and deliver specified products for OEMs with volume requests. Our Applications and Engineering Departments will work closely with your design team through all stages of development in order to provide the best servo drive solution for your system. Equipped with on-site manufacturing for quick-turn customs capabilities, ADVANCED Motion Controls utilizes our years of engineering and manufacturing expertise to decrease your costs and time-to-market while increasing system quality and reliability.

**Examples of Customized Products**

- ▲ Optimized Footprint
- ▲ Private Label Software
- ▲ OEM Specified Connectors
- ▲ No Outer Case
- ▲ Increased Current Resolution
- ▲ Increased Temperature Range
- ▲ Custom Control Interface
- ▲ Integrated System I/O
- ▲ Tailored Project File
- ▲ Silkscreen Branding
- ▲ Optimized Base Plate
- ▲ Increased Current Limits
- ▲ Increased Voltage Range
- ▲ Conformal Coating
- ▲ Multi-Axis Configurations
- ▲ Reduced Profile Size and Weight

Feel free to contact Applications Engineering for further information and details.

**Available Accessories**

ADVANCED Motion Controls offers a variety of accessories designed to facilitate drive integration into a servo system. Visit [www.a-m-c.com](http://www.a-m-c.com) to see which accessories will assist with your application design and implementation.

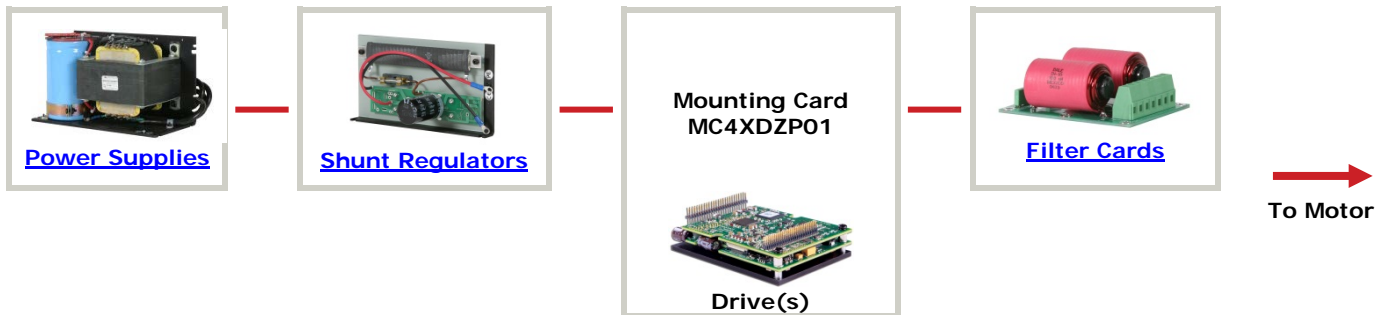

All specifications in this document are subject to change without written notice. Actual product may differ from pictures provided in this document.