

1 Introduction

This document covers the steps to retrofit an AxCent™ servo drive into an existing Brushed or Brushless Analog drive application. The information in this document relates specifically to the “large size” AxCent models (see Table 2 below) that replace existing analog drive models (see Table 1 below).



1.1 AxCent™ Platform

The new AxCent models are replacing older analog products that are reaching end-of-life due to component obsolescence. The AxCent platform is designed to integrate multiple existing analog products into a smaller number of base models that include common features and are designed to easily support custom modifications.

The large size AxCent platform replaces the following existing analog series of servo drives.

Brushed			Brushless			
30A8	30A8I	16A20AC	B30A8	BE30A8	BE30A8I	BE25A20I
50A8	50A8I	30A20AC	B40A8	BE40A8	B30A8I	BE40A20I
25A20	25A20I		B25A20	BE25A20	B25A20I	B25A20AC
50A20	50A20I		B40A20	BE40A20	B40A20I	BE25A20AC

Table 1 Discontinued Analog Drive Families Being Replaced by Large AxCent Models

1.1.1 AxCent Models

The table below lists the model numbers and overall power capabilities for large size AxCent drives.

	Models	Peak (A)	Cont (A)	Supply (VDC)	Supply (VAC)	Dimensions	Release Date
Brushless/Brushed	AB30A100	30	15	20-80	-	7.5 x 4.3 x 1.1 (inches)	12/2016
	AB50A100	50	25	20-80	-		11/2016
	AB30A200	30	15	40-175	-		03/2017
	AB30A200I	30	15	40-175	-	7.5 x 4.3 x 2.5 (inches)	07/2017
	AB30A200AC	30	15	-	30-125		10/2016
	AB50A200	50	25	40-175	-		03/2017
Brushed Only	A30A100	30	15	20-80	-	7.5 x 4.3 x 1.1 (inches)	3/2017
	A50A100	50	25	20-80	-		
	A25A200	25	12.5	40-175	-		
	A50A200	50	25	40-175	-		

Table 2 AxCent Model Numbers

The model mask for the new AxCent drive models is given below. Note that not all possible part number combinations are standard off-the-shelf offerings. Isolated versions of certain off-the-shelf models will be available for OEM orders. Additionally, an AC-supplied model is planned for 2017 release.

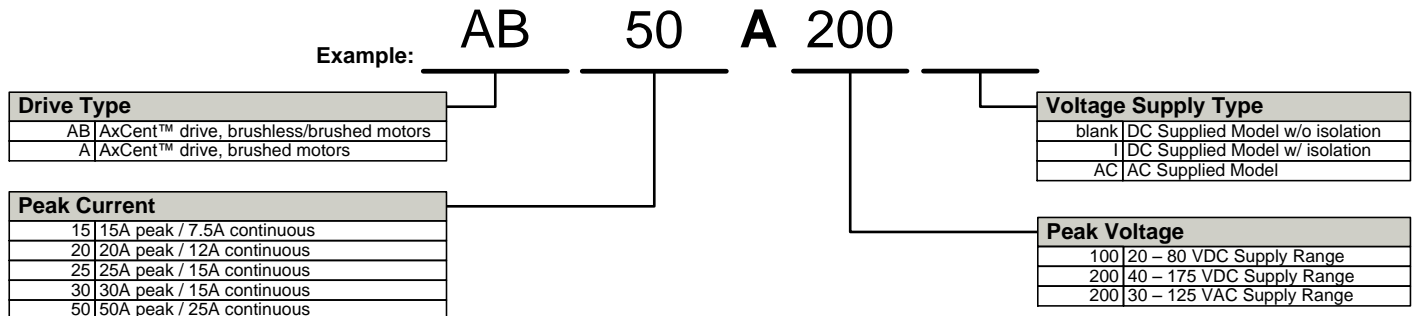

Figure 1 AxCent Model Mask

1.2 Large Size AxCent - Replacement Charts

For an existing analog drive and the specific mode of operation in use, the table below indicates the AxCent drive model that will serve as the corresponding replacement.

Note: Older analog part numbers use a revision letter at the end of the base model number, and may include an extension at the end of the part number to designate specific ordering options or customer-specific modifications.

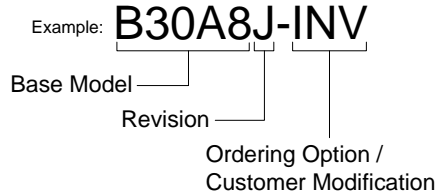

Figure 2 Existing Analog Drive Part Numbering

The AxCent replacement will be determined by the base model number of the existing analog drive. The standard ordering options that were available for existing analog drives are no longer used with the AxCent platform.

- INV models: Inverted inhibit/enable logic. AxCent models feature a dedicated DIP Switch to toggle the inhibit/enable logic.
- ANP models: Analog position loop configuration. Analog position loop is not supported in the AxCent platform. It is recommended to switch to the DigiFlex® Performance™ family of digital servo drives for position control. Please contact ADVANCED Motion Controls for assistance.

	Existing Analog Part Number	Mode of Operation	AxCent Replacement Part Number	Configuration Information
Large Size	30A8 30A8I	Current Voltage Tachometer Velocity	AB30A100	Section 2.1
		IR Compensation	A30A100	Section 2.2
	50A8 50A8I	Current Voltage Tachometer Velocity	AB50A100 AB50A100I	Section 2.1
		IR Compensation	A50A100	Section 2.2
	25A20 25A20I	Current Voltage Tachometer Velocity	AB30A200 AB30A200I	Section 2.1
		IR Compensation	A25A200	Section 2.2
	50A20 50A20I	Current Voltage Tachometer Velocity	AB50A200 AB50A200I	Section 2.1
		IR Compensation	A50A200	Section 2.2
	B30A8 B30A8I BE30A8 BE30A8I	Current Duty Cycle Hall Velocity Encoder Velocity Tachometer Velocity	AB30A100	Section 2.1
		B40A8 B40A8I BE40A8 BE40A8I	Current Duty Cycle Hall Velocity Encoder Velocity Tachometer Velocity	AB50A100 AB50A100I
	B25A20 B25A20I BE25A20 BE25A20I		Current Duty Cycle Hall Velocity Encoder Velocity Tachometer Velocity	AB30A200 AB30A200I
		B40A20 B40A20I BE40A20 BE40A20I	Current Duty Cycle Hall Velocity Encoder Velocity Tachometer Velocity	AB50A200 AB50A200I
	16A20AC 30A20AC B25A20AC BE25A20AC		Current Duty Cycle Hall Velocity Encoder Velocity Tachometer Velocity	AB30A200AC

Table 3 AxCent Replacement Chart – Large Size

2 Installation

2.1 Large Size AxCent – Brushless Drives Installation and Configuration

This section covers the basic connections and setup for large size brushless AxCent drives, and highlights the differences from the existing analog products. For additional information and in-depth wiring, configuration, and feature functionality consult the AxCent Hardware Installation Manual, available for download at www.a-m-c.com.



Figure 3 Existing brushless analog drive and new brushless AxCent drive

2.1.1 Dimensions

The new AxCent models match the physical and mounting dimensions of existing analog products as shown below in the following figure. Full mounting dimensions can be found on the drive datasheets.

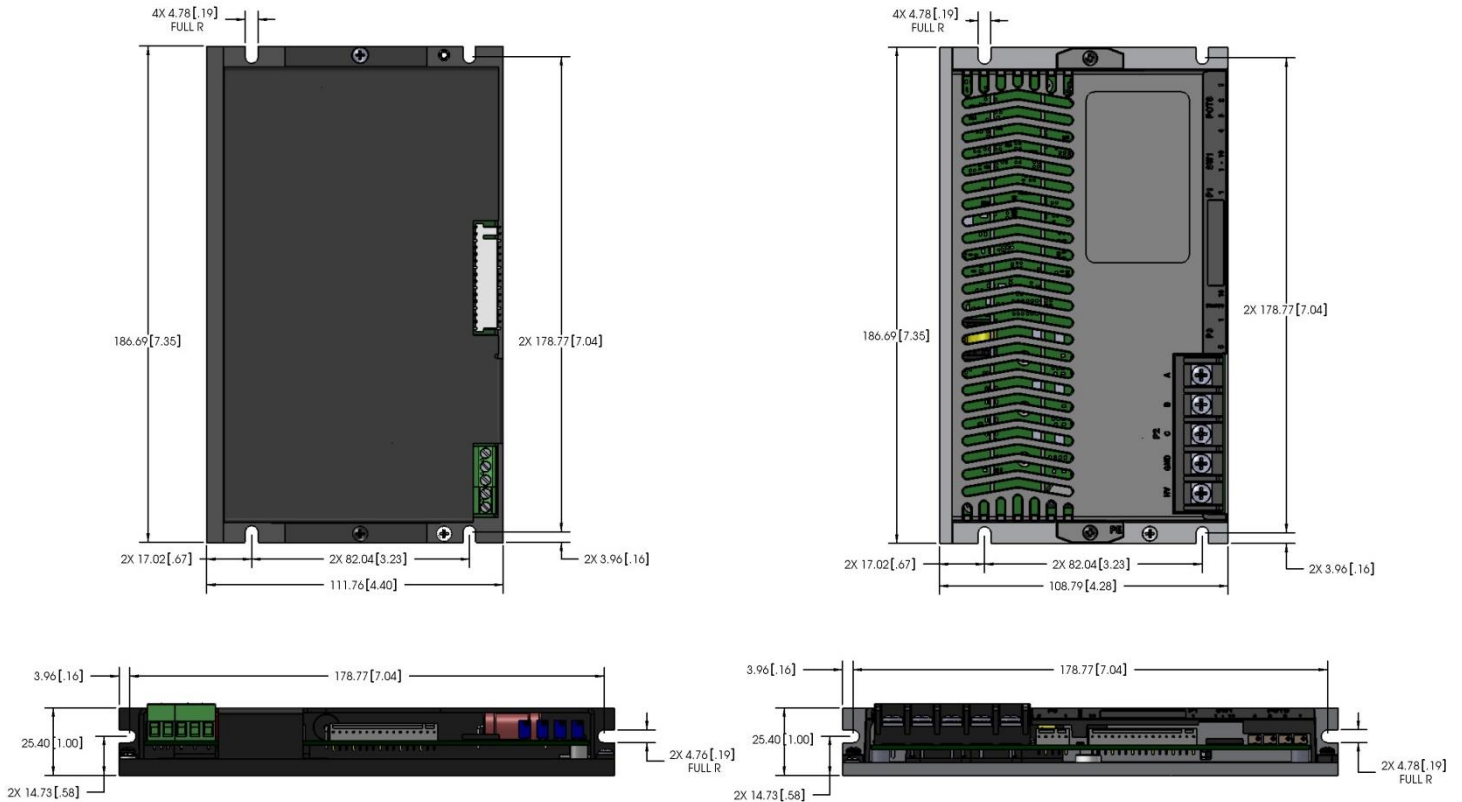

Figure 4 Mounting dimensions comparison

2.1.2 Connectors

Large size brushless AxCent drives feature the same number of connectors as the existing analog drive models. The connector types are listed below. Mating connectors for both P1 and P3 are included with the drive.

Existing analog drive connectors		AxCent connectors	
Connector	Description	Connector	Description
P1 – Signal	16-pin, 2.54 mm spaced, friction lock header	P1 – Signal	16-pin, 2.54 mm spaced, friction lock header
P2 – Motor/Power	5-port, 5.08 mm spaced, screw terminal	P2 – Motor/Power	5-port, 11.10 mm spaced, screw terminal
P3 – Encoder	5-port, 2.54 mm spaced, friction lock header	P3 – Encoder	5-port, 2.54 mm spaced, friction lock header

Table 4 Connectors

2.1.2.1 Motor and Power Connector – P2

The existing analog models used a 5.08 mm spaced screw terminal connector for the motor and power connections. The new large size AxCent models use a larger, 11.10 mm spaced fixed screw terminal for motor and power connections.

Existing analog motor/power connector

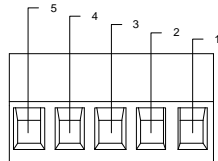

AxCent motor/power connector

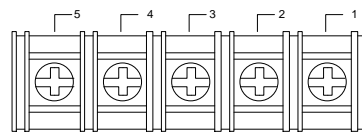

Figure 5 P2 Connector – Existing Analog and AxCent Drives

The motor and power connector for the existing analog models and the new large size AxCent models are shown below.

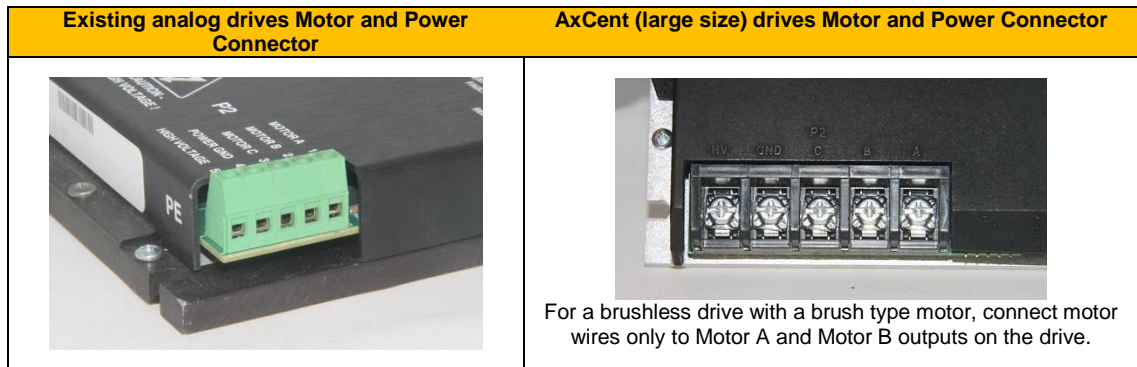

Figure 6 Motor and Power Connector

2.1.2.1.1 PE Connection

The PE connection terminal on the new AxCent models is the silver screw terminal on the lower right corner of the drive baseplate. This is the same location as on the existing analog models. This PE ground connection terminal should be connected to a single point system ground. **Do not use the screw attaching the drive cover to the baseplate as the PE connection point!** Note that the “PE” label on the new AxCent models is embossed into the case, while on the existing analog models the “PE” label was silkscreened.

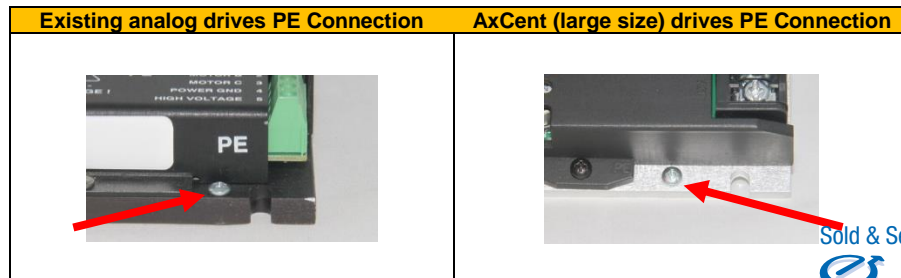

Figure 7 PE Connection Terminal Location

2.1.2.2 Signal Connector – P1

The Signal connector on the new AxCent models is the same physical connector used on the existing analog product. The mating connector is included with the drive shipment.

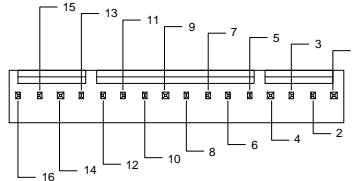

Figure 8 P1 Connector – Existing Analog and AxCent Drives

The pinout on the new AxCent models has changed slightly and is reproduced in the tables below. Table 4 shows the pinout for existing brushless analog drives and the new brushless AxCent models.

Existing Analog Models Signal Connector Pinout		AxCent Models Signal Connector Pinout	
B30A8	BE30A8	AB30A100	
B40A8	BE40A8	AB50A100	
B25A20	BE25A20	AB30A200	
B40A20	BE40A20	AB50A200	
Pin	Name	Name	Changes
1	+10V 3mA OUT	+10V 3mA OUT	
2	SIGNAL GND	SIGNAL GND	
3	-10V 3mA OUT	-10V 3mA OUT	
4	+REF IN	+REF IN	
5	-REF IN	-REF IN	
6	-TACH IN	-TACH IN	
7	VEL MONITOR OUT	VEL MONITOR OUT	
8	CURRENT MONITOR	CURR MONITOR OUT	
9	INHIBIT IN	INHIBIT / ENABLE	The inhibit pin behavior is configured via DIP Switch on new AxCent drives.
10	+V HALL 30mA OUT	+V HALL 30mA OUT	
11	GND	GND	
12	HALL 1	HALL 1	
13	HALL 2	HALL 2	
14	HALL 3	HALL 3	
15	CURR REF OUT	CURR REF OUT	
16	FAULT OUT	FAULT OUT	

Table 5 Signal Connector Pinouts – Brushless Drives

2.1.2.3 Feedback Connector – P3

The Feedback connector on the new AxCent models is the same physical connector used on the existing analog Encoder Velocity capable products. The mating connector is included with the drive shipment.

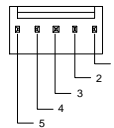

Figure 9 P3 Connector – Existing Analog and AxCent Drives

Existing Analog Models Signal Pinout		AxCent Models Signal Pinout	
BE30A8		AB30A100	
BE40A8		AB50A100	
BE25A20		AB30A200	
BE40A20		AB50A200	
Pin	Name	Name	
1	+5V	+5V	
2	CHANNEL A	CHANNEL A	
3	NC	NC	
4	CHANNEL B	CHANNEL B	
5	SIGNAL GND	SIGNAL GND	

Table 6 Feedback Connector Pinouts – Brushless Drives

2.1.3 Drive Configuration

The new large size AxCent drives are configured through DIP switches and potentiometers, similar to the existing analog products. However, new AxCent drives use multiple DIP switch banks, whereas the existing analog products used only a single DIP switch bank.

Existing Analog Products DIP Switch Banks		AxCent DIP Switch Banks	
Switch	Description	Switch	Description
SW1	10-Position, drive setup and configuration	SW1	10-Position, drive setup and configuration
		SW2	4-Position, tachometer feedback scaling, current options
		SW3	10-Position, advanced tuning
		SW4	10-Position, advanced tuning, current scaling

Table 7 DIP Switch Banks – Brushless Drives

2.1.3.1 SW1 DIP Switch Settings (Drive Setup and Configuration)

The configuration settings for DIP switch SW1 are given below for existing brushless analog products and new brushless AxCent models. The drive case does not need to be removed to access SW1.

Switch	Description	On	Off
1	Test/Offset	Test	Offset
2	Current Loop Proportional Gain	Decrease	Increase
3	Current Scaling	Full Current	Half Current
4	Outer Loop Integration	Inactive	Active
5	Mode Selection	-	-
6	Mode Selection	-	-
7	Velocity Feedback Polarity	Standard	Inverted
8	Current Ratio between Peak and Continuous Current	50%	25%
9	Outer Loop Integral Gain Adjustment	Decrease	Increase
10	Hall Sensor Phasing	120°	60°

Table 8 Existing Analog Brushless Drives SW1 DIP Switch Settings

Switch	Description	On	Off
1	Test/Offset	Test	Offset
2	Inhibit Logic	Inhibit Active Low	Inhibit Active High
3	Current Scaling	Full Current	Half Current
4	Outer Loop Integration	Inactive	Active
5	Mode Selection	-	-
6	Mode Selection	-	-
7	Velocity Feedback Polarity	Standard	Inverted
8	Mode Selection	-	-
9	Reserved	-	-
10	Hall Sensor Phasing	120°	60°

Table 9 AxCent Brushless Drives SW1 DIP Switch Settings

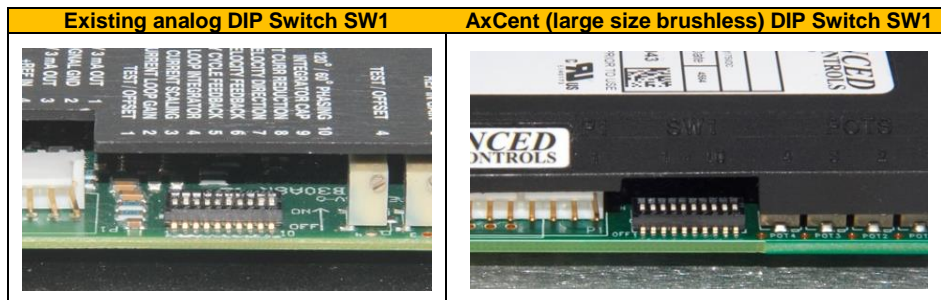

Figure 10 Configuration DIP Switch SW1

Sold & Serviced By:

 **ELECTROMATE**

Toll Free Phone (877) SERV098

Toll Free Fax (877) SERV099

www.electromate.com

sales@electromate.com

2.1.3.2 SW2 DIP Switch Settings (Tachometer Scaling and Current Limiting)

The configuration settings for DIP switch SW2 are given below for new brushless AxCent models. The drive case must be removed to access SW2.

Switch	Description	On	Off
1	Tach Input Voltage Scaling. Adjusts the maximum range of the tachometer input.	Max tachometer input values from 5V to 61V. See drive datasheet for switch settings.	
2			
3			
4	Continuous Current Only	Peak/Cont	No Peak

Table 10 AxCent Brushless Drives SW2 DIP Switch Settings

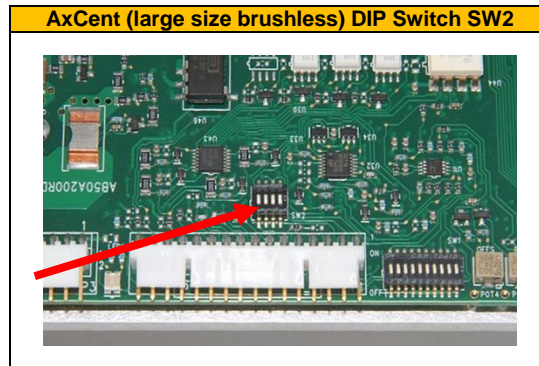

Figure 11 AxCent - DIP Switch SW2

2.1.3.3 SW3 DIP Switch Settings (Advanced Tuning)

DIP switch SW3 on new brushless AxCent models is used for advanced tuning purposes. The drive case must be removed to access SW3. See section 2.1.4 in this document for more information, and consult the drive datasheet for specific switch settings.

2.1.3.4 SW4 DIP Switch Settings (Advanced Tuning and Current Limiting)

The configuration settings for DIP switch SW4 are given below for new brushless AxCent models. The drive case must be removed to access SW4.

Switch	Description	Settings
1	Advanced Tuning (Velocity Loop Integrator Capacitance)	See section 2.14 in this document for more information, and consult the drive datasheet for switch settings and capacitance values.
2		
3		
4		
5	Continuous Current Scaling. Reduces the continuous current limit to a percentage of peak current. Does not affect peak current.	Continuous current values between 50% and 7.75% of Peak Current. See drive datasheet for switch settings.
6		
7		
8	Peak and Continuous Current Scaling. Scales both peak and continuous current limits.	Current limit values between full peak/cont limit and half peak/cont limit. See drive datasheet for switch settings.
9		
10		

Table 11 AxCent Brushless Drives SW4 DIP Switch Settings

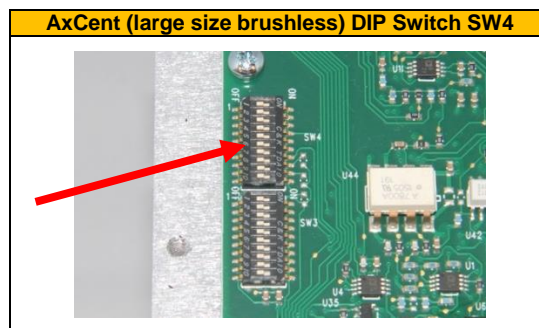

Figure 12 AxCent - DIP Switch SW4

2.1.3.5 Mode Selection

Mode of Operation DIP switch settings are different on the new brushless AxCent models than they were on the existing brushless analog products. Note that not all DIP switches are used in mode selection.

Mode	SW1-5	SW1-6	SW1-8	Encoder	Tach
Current	OFF	OFF	ON	NC	NC
Duty Cycle	ON	OFF	OFF	NC	NC
Encoder Velocity	OFF	OFF	OFF	Connected	NC
Hall Velocity	OFF	ON	OFF	NC	NC
Tachometer Velocity	OFF	OFF	OFF	NC	Connected

Table 12 Mode Selection Table – AxCent Drives

2.1.3.6 Potentiometers

AxCent models feature the same four on-board potentiometers as the previous analog drive models. The potentiometers are approximately linear and have 12 active turns, with 1 inactive turn on each end. AxCent models use lower-profile potentiometers than the previous analog versions. The drive case does not need to be removed to access the potentiometers.

Pot	Description	Turning CW
1	Loop gain adjustment for duty cycle / velocity modes. Turn this pot fully CCW in current mode.	Increases gain
2	Current limit. It adjusts both continuous and peak current limit while maintaining their ratio.	Increases limit
3	Reference gain. Adjusts the ratio between input signal and output variables (voltage, current, or velocity).	Increases gain
4	Offset / Test. Used to adjust any imbalance in the input signal or in the drive. Can also be used as an on-board signal source for testing purposes.	Adjusts offset in negative direction

Table 13 Potentiometers

2.1.4 Advanced Tuning

The new large size brushless AxCent models contain additional DIP switch banks SW3 and SW4 underneath the drive cover that can be used for additional drive tuning. SW3 adds additional resistance to the current loop gain resistor and additional capacitance to the current loop integrator capacitor, and SW4 adds additional capacitance to the velocity loop integrator capacitor.

The tuning DIP switch banks on the new large size brushless AxCent models are shown below (drive cover removed). Values for the switch settings can be found on the drive datasheet.

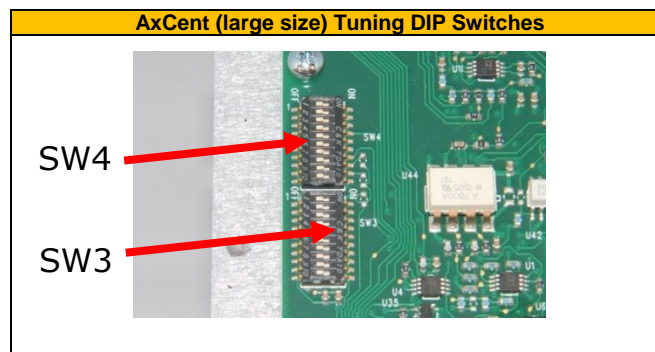

Figure 13 Tuning DIP Switches

2.2 Large Size AxCent – Brushed Drives Installation and Configuration

This section covers the basic connections and setup for large size brushed AxCent drives, and highlights the differences from the existing brushed analog products. For additional information and in-depth wiring, configuration, and feature functionality, consult the AxCent Hardware Installation Manual, available for download at www.a-m-c.com.



Figure 14 Existing brushed analog drive and new brushed AxCent drive

2.2.1 Dimensions

The new AxCent models match the physical and mounting dimensions of existing analog products as shown below in the following figure. Full mounting dimensions can be found on the drive datasheets.

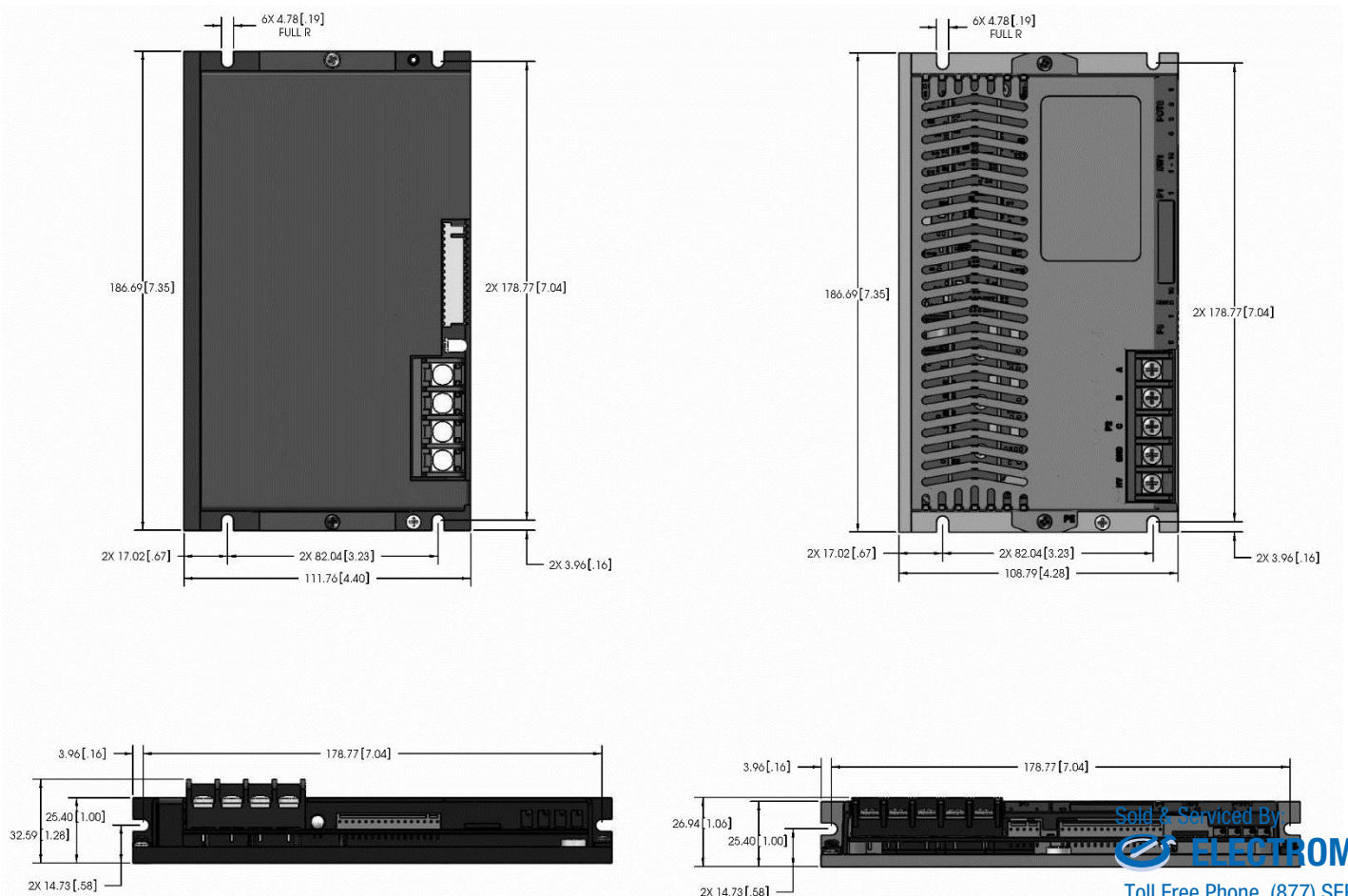

Figure 15 Mounting dimensions comparison

2.2.2 Connectors

Large size brushed AxCent drives feature the same number of connectors as the previous analog drive models. The connector types are listed below. The mating connector for P1 is included with the drive.

Existing analog drive connectors		AxCent connectors	
Connector	Description	Connector	Description
P1 – Signal	16-pin, 2.54 mm spaced, friction lock header	P1 – Signal	16-pin, 2.54 mm spaced, friction lock header
P2 – Motor/Power	4-port, 11.10 mm spaced, screw terminal	P2 – Motor/Power	5-port, 11.10 mm spaced, screw terminal

Table 14 Connectors

2.2.2.1 Motor and Power Connector – P2

The existing analog models use a 4-port, 11.10 mm spaced screw terminal connector for the motor and power connections. The new large size AxCent models use a 5-port, 11.10 mm spaced fixed screw terminal for motor and power connections.

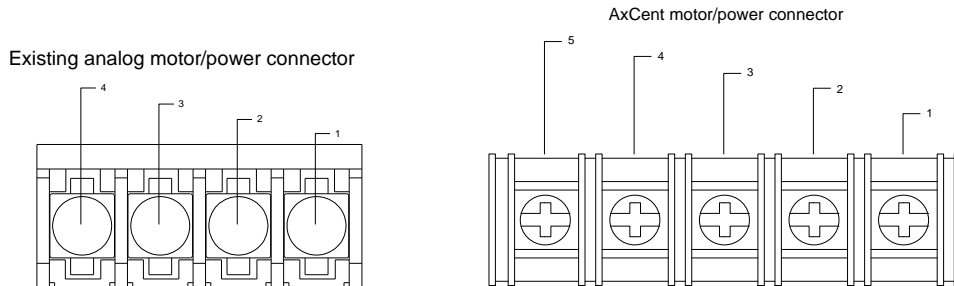

Figure 16 P2 Connector – Existing Analog and AxCent Drives

The motor and power connector for the reserved analog models and the new large size AxCent models are shown below.

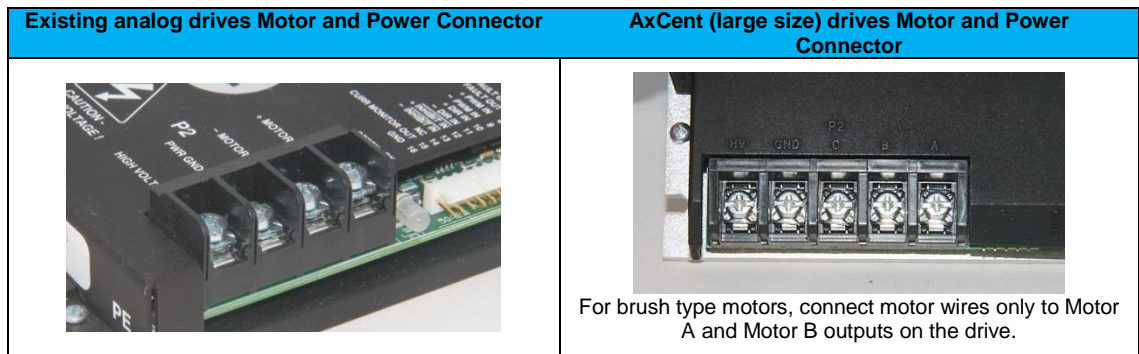

Figure 17 Motor and Power Connector

2.2.2.1.1 PE Connection

The PE connection terminal on the new AxCent models is the silver screw terminal on the lower right corner of the drive baseplate. This is the same location as on the existing analog models. This PE ground connection terminal should be connected to a single point system ground. **Do not use the screw attaching the drive cover to the baseplate as the PE connection point!** Note that the “PE” label on the new AxCent models is embossed into the case, while on the existing analog models the “PE” label was silkscreened.

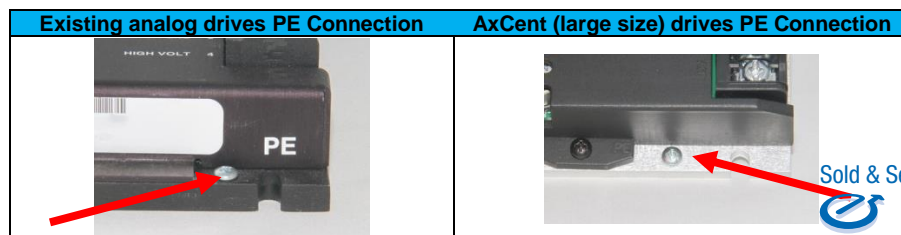

Figure 18 PE Connection Terminal Location

2.2.2.2 Signal Connector – P1

The Signal connector on the new AxCent models is the same physical connector used on the existing analog product. The mating connector is included with the drive shipment.

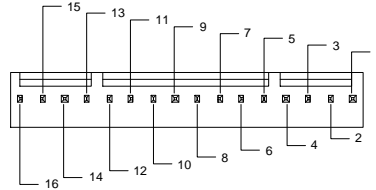

Figure 19 P1 Connector – Existing Analog and AxCent Drives

The pinout on the new AxCent models has changed slightly and is reproduced in the tables below. Table 4 shows the pinout for existing brushed analog drives and the new brushed AxCent models

Existing Analog Models Signal Connector Pinout		AxCent Models Signal Connector Pinout	
30A8		A30A100	
50A8		A50A100	
25A20		A25A200	
50A20		A50A200	
Pin	Name	Name	Changes
1	+10V 3mA OUT	+10V 3mA OUT	
2	SIGNAL GND	SIGNAL GND	
3	-10V 3mA OUT	-10V 3mA OUT	
4	+REF IN	+REF IN	
5	-REF IN	-REF IN	
6	-TACH IN	-TACH IN	
7	+TACH / GND	+TACH / GND	
8	CURR MONITOR OUT	CURR MONITOR OUT	
9	CURR REF OUT	CURR REF OUT	
10	CONT CURRENT LIMIT	CONT CURRENT LIMIT	
11	INHIBIT IN	INHIBIT / ENABLE	The inhibit pin behavior is configured via DIP Switch on new AxCent drives.
12	+INHIBIT IN	+ INHIBIT / ENABLE	
13	-INHIBIT IN	- INHIBIT / ENABLE	
14	FAULT OUT	FAULT OUT	
15	NC	NC	
16	NC	NC	

Table 15 Signal Connector Pinouts – Brushed Drives

Sold & Serviced By:



Toll Free Phone (877) SERV098

Toll Free Fax (877) SERV099

www.electromate.com

sales@electromate.com

2.2.3 Drive Configuration

The new large size brushed AxCent drives are configured through DIP switches and potentiometers, similar to the existing analog products. However, new AxCent drives use multiple DIP switch banks, whereas the existing analog products used only a single DIP switch bank.

Existing Analog Products DIP Switch Banks		AxCent DIP Switch Banks	
Switch	Description	Switch	Description
SW1	10-Position, drive setup and configuration	SW1	10-Position, drive setup and configuration
		SW2	4-Position, tachometer feedback scaling, current options
		SW3	10-Position, advanced tuning
		SW4	10-Position, advanced tuning, current scaling

Table 16 DIP Switch Banks – Brushless Drives

2.2.3.1 SW1 DIP Switch Settings (Drive Setup and Configuration)

The configuration settings for DIP switch SW1 are given below for existing brushed analog products and new brushed AxCent models. The drive case does not need to be removed to access SW1.

Switch	Description	On	Off
1	Voltage Feedback	On	Off
2	IR Compensation Feedback	On	Off
3	Current Loop Proportional Gain Adjustment	Decrease	Increase
4	Current Loop Integral Gain Adjustment	Decrease	Increase
5	Current Scaling	Full Current	Half Current
6	Current Ratio between Peak and Continuous Current	50%	25%
7	Current Loop Integral Gain	Inactive	Active
8	Outer Loop Integral Gain	Inactive	Active
9	Outer Loop Integral Gain Adjustment	Decrease	Increase
10	Test/Offset	Test	Offset

Table 17 Existing Analog Brushed Drives SW1 DIP Switch Settings

Switch	Description	On	Off
1	Test/Offset	Test	Offset
2	Inhibit Logic	Inhibit Active Low	Inhibit Active High
3	Current Scaling	Full Current	Half Current
4	Outer Loop Integration	Inactive	Active
5	Mode Selection	-	-
6	Mode Selection	-	-
7	Reserved	-	-
8	Mode Selection	-	-
9	Reserved	-	-
10	IR Compensation Feedback	On	Off

Table 18 AxCent Brushed Drives SW1 DIP Switch Settings

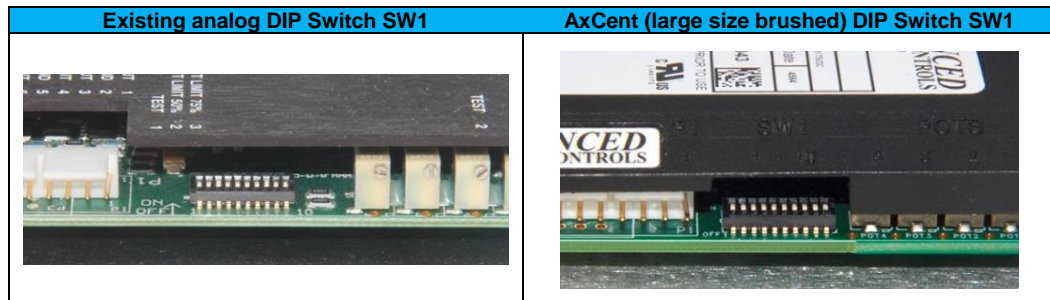

Figure 20 Configuration DIP Switch SW1

Sold & Serviced By:

 **ELECTROMATE**

Toll Free Phone (877) SERV098

Toll Free Fax (877) SERV099

www.electromate.com

sales@electromate.com

2.2.3.2 SW2 DIP Switch Settings (Tachometer Scaling and Current Limiting)

The configuration settings for DIP switch SW2 are given below for new brushed AxCent models. The drive case must be removed to access SW2.

Switch	Description	On	Off
1	Tach Input Voltage Scaling. Adjusts the maximum range of the tachometer input.	Max tachometer input values from 5V to 61V. See drive datasheet for switch settings.	
2			
3			
4	Continuous Current Only	Peak/Cont	Continuous Current Only

Table 19 AxCent Brushed Drives SW2 DIP Switch Settings

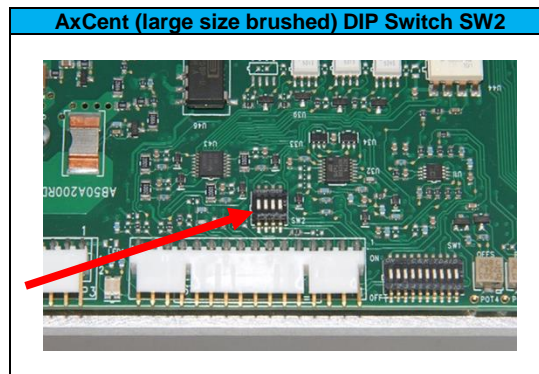

Figure 21 AxCent - DIP Switch SW2

2.2.3.3 SW3 DIP Switch Settings (Advanced Tuning)

DIP switch SW3 on new brushed AxCent models is used for advanced tuning purposes. The drive case must be removed to access SW3. See section 2.2.4 in this document for more information, and consult the drive datasheet for specific switch settings.

2.2.3.4 SW4 DIP Switch Settings (Advanced Tuning and Current Limiting)

The configuration settings for DIP switch SW4 are given below for new brushed AxCent models. The drive case must be removed to access SW4.

Switch	Description	Settings
1	Advanced Tuning (Velocity Loop Integrator Capacitance)	See Section 2.24 in this document for more information, and consult the drive datasheet for switch settings and capacitance values.
2		
3		
4		
5	Continuous Current Scaling. Reduces the continuous current limit to a percentage of peak current. Does not affect peak current.	Continuous current values between 50% and 7.75% of Peak Current. See drive datasheet for switch settings.
6		
7		
8	Peak and Continuous Current Scaling. Scales both peak and continuous current limits.	Current limit values between full peak/cont limit and half peak/cont limit. See drive datasheet for switch settings.
9		
10		

Table 20 AxCent Brushed Drives SW4 DIP Switch Settings

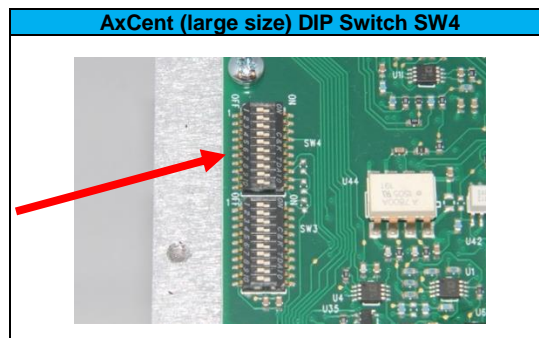

Figure 22 AxCent - DIP Switch SW4

2.2.3.5 Mode Selection

Mode of Operation DIP switch settings are different on the new brushed AxCent models than they were on the existing brushed analog products. Note that not all DIP switches are used in mode selection.

Mode	SW1-5	SW1-6	SW1-8	SW1-10	Tach
Current	OFF	OFF	ON	OFF	NC
Duty Cycle	ON	OFF	OFF	OFF	NC
Voltage	OFF	ON	OFF	OFF	NC
Tachometer Velocity	OFF	OFF	OFF	OFF	Connected
IR Compensation*	OFF	OFF	OFF	ON	NC

Table 21 Mode Selection Table – AxCent Drives

*Note: IR Compensation mode requires an additional SMT resistor to be added to the drive PCB. Contact ADVANCED Motion Controls for information and instructions on configuring the drive for this mode.

2.2.3.6 Potentiometers

AxCent models feature the same four on-board potentiometers as the previous analog drive models. The potentiometers are approximately linear and have 12 active turns, with 1 inactive turn on each end. AxCent models use lower-profile potentiometers than the previous analog versions. The drive case does not need to be removed to access the potentiometers.

Pot	Description	Turning CW
1	Loop gain adjustment for voltage / duty cycle / velocity modes. Turn this pot fully CCW in current mode.	Increases gain
2	Current limit. It adjusts both continuous and peak current limit while maintaining their ratio.	Increases limit
3	Reference gain. Adjusts the ratio between input signal and output variables (voltage, current, or velocity).	Increases gain
4	Offset / Test. Used to adjust any imbalance in the input signal or in the drive. Can also be used as an on-board signal source for testing purposes.	Adjusts offset in negative direction

Table 22 Potentiometers

2.2.4 Advanced Tuning

The new large size brushed AxCent models contain additional DIP switch banks SW3 and SW4 underneath the drive cover that can be used for additional drive tuning. SW3 adds additional resistance to the current loop gain resistor and additional capacitance to the current loop integrator capacitor and SW4 adds additional capacitance to the velocity loop integrator capacitor.

The tuning DIP switch banks on the new large size brushed AxCent models are shown below (drive cover removed). Values for the switch settings can be found on the drive datasheet.

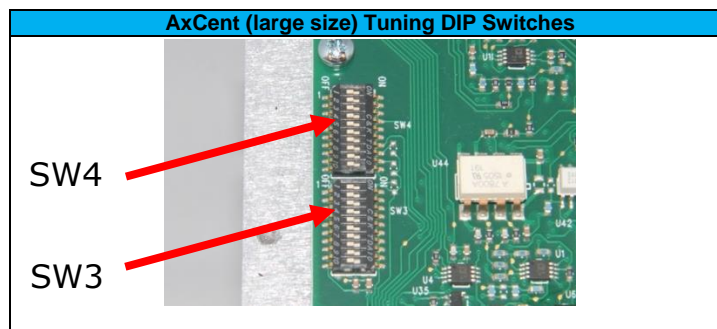

Figure 23 Tuning DIP Switches

Sold & Serviced By:

 **ELECTROMATE**

Toll Free Phone (877) SERV098

Toll Free Fax (877) SERV099

www.electromate.com

sales@electromate.com